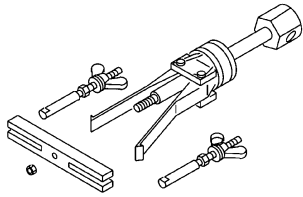
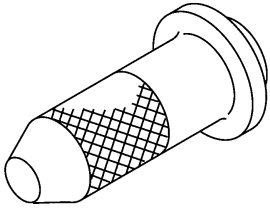
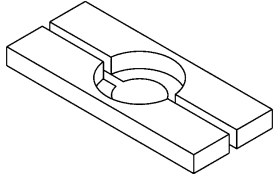
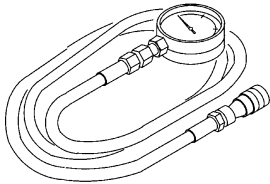
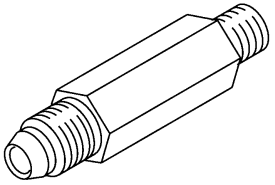
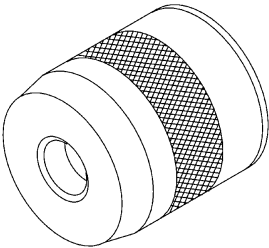
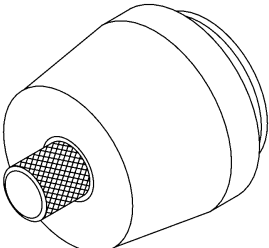
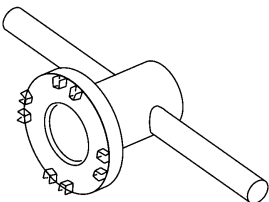
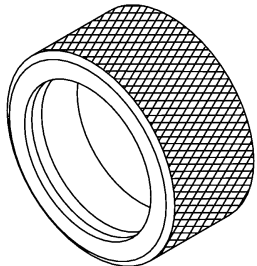
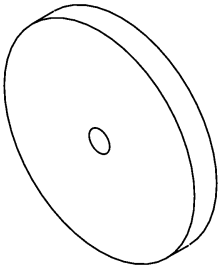

**SPECIAL TOOLS****[G300] 1-6****3. Automatic Transmission and Differential Tools****3. Automatic Transmission and Differential Tools**

ILLUSTRATION	TOOL NUMBER	DESCRIPTION	REMARKS
 <p>B1H0138</p>	398527700	PULLER ASSY	Used for removing One-way clutch needle bearing.
 <p>G1H0188</p>	498057300	INSTALLER	Used for installing extension oil seal.
 <p>G1H0156</p>	498077000	REMOVER	Used for removing differential taper roller bearing.
 <p>B1H0139</p>	498575400	OIL PRESSURE GAUGE ASSY	Used for measuring oil pressure.
 <p>G1H0194</p>	498897200	ADAPTER	Used on oil pump housing when measuring reverse clutch pressure and line pressure.

**1-6 [G300]****SPECIAL TOOLS****3. Automatic Transmission and Differential Tools**

ILLUSTRATION	TOOL NUMBER	DESCRIPTION	REMARKS
 <p>B1H0227</p>	499247400	INSTALLER	<ul style="list-style-type: none"> <li>Used for installing transfer outer snap ring.</li> <li>Used with GUIDE (499257300).</li> </ul>
 <p>B1H0228</p>	499257300	GUIDE	<ul style="list-style-type: none"> <li>Used for installing transfer outer snap ring.</li> <li>Used with INSTALLER (499247400).</li> </ul>
 <p>G1H0169</p>	499787000	WRENCH ASSY	Used for removing and installing differential side retainer.
 <p>G1H0200</p>	398437700	DRIFT	Used for installing converter case oil seal.
 <p>B1H0222</p>	398497701	INSTALLER	Used for installing converter case oil seal.

**SPECIAL TOOLS****[G300] 1-6****3. Automatic Transmission and Differential Tools**

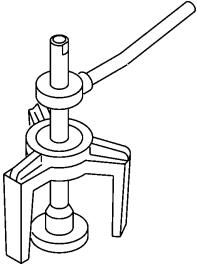
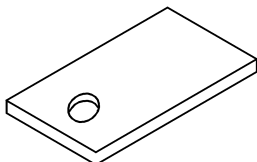
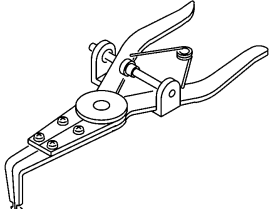
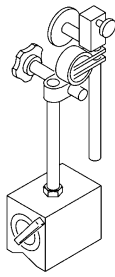
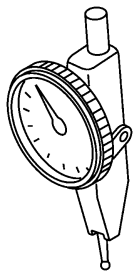
ILLUSTRATION	TOOL NUMBER	DESCRIPTION	REMARKS
 <p>B1H0140</p>	398673600	COMPRESSOR	Used for removing and installing clutch spring.
 <p>B1H0285</p>	498255400	PLATE	Used for measuring backlash of hypoid gear.
 <p>B1H0142</p>	399893600	PLIER	Used for removing and installing clutch spring.
 <p>B1H0137</p>	498247001	MAGNET BASE	<ul style="list-style-type: none"> <li>• Used for measuring gear backlash.</li> <li>• Used with DIAL GAUGE (498247100).</li> </ul>
 <p>G1H0160</p>	498247100	DIAL GAUGE	<ul style="list-style-type: none"> <li>• Used for measuring gear backlash.</li> <li>• Used with MAGNET BASE (498247001).</li> </ul>

**1-6 [G300]****SPECIAL TOOLS****3. Automatic Transmission and Differential Tools**

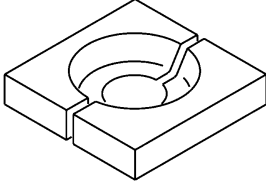
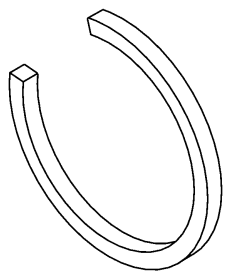
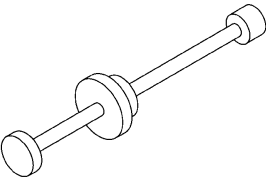
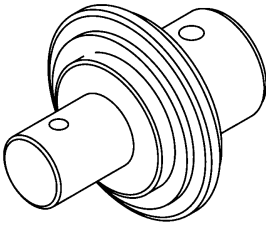
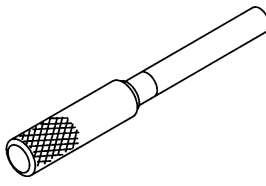
ILLUSTRATION	TOOL NUMBER	DESCRIPTION	REMARKS
 <p>G1H0379</p>	498517000	REPLACER	Used for removing front roller bearing.
 <p>B1H0231</p>	398623600	SEAT	Used for removing snapping of transfer clutch piston.
 <p>B1H0232</p>	499095500	REMOVER ASSY	Used for removing axle shaft.
 <p>G1H0209</p>	499247300	INSTALLER	<ul style="list-style-type: none"> <li>• Used for removing axle shaft.</li> <li>• Used with REMOVER (499095500).</li> </ul>
 <p>G1H0210</p>	499267300	STOPPER PIN	Used for installing inhibitor switch.

**SPECIAL TOOLS****[G300] 1-6****3. Automatic Transmission and Differential Tools**

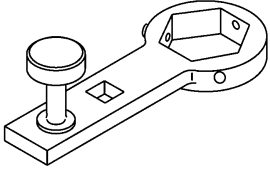
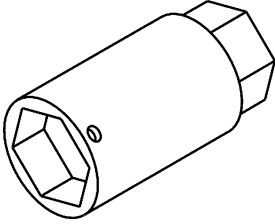
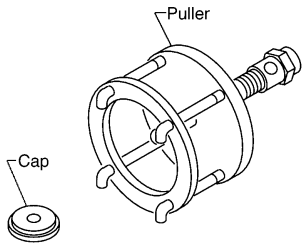
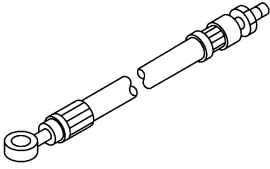
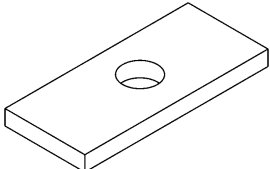
ILLUSTRATION	TOOL NUMBER	DESCRIPTION	REMARKS
 <p>G1H0211</p>	499787700	WRENCH ASSY	Used for removing and installing drive pinion lock nut.
 <p>B1H0169</p>	499787500	ADAPTER ASSY	Used for removing and installing drive pinion lock nut.
 <p>Cap Puller</p> <p>B1H0135B</p>	899524100	PULLER SET	Used for removing reduction gear.
 <p>G1H0214</p>	498897700	ADAPTER SET	Used with OIL PRESSURE GAUGE ASSY.
 <p>B1H0233</p>	398643600	GAUGE	Used for measuring total end play, extension end play and drive pinion height.

**1-6 [G300]****SPECIAL TOOLS****3. Automatic Transmission and Differential Tools**

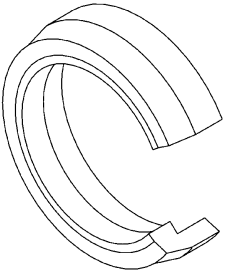
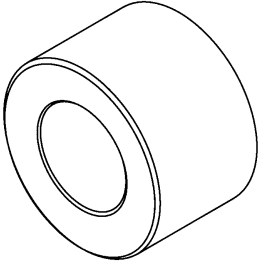
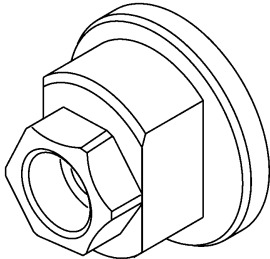
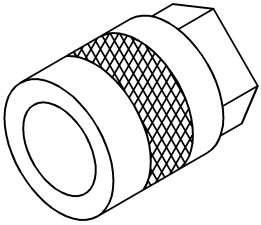
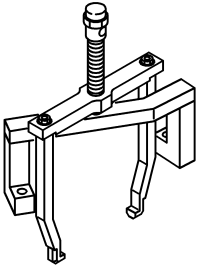
ILLUSTRATION	TOOL NUMBER	DESCRIPTION	REMARKS
 <p>B1H0234</p>	498627100	SEAT	Used for holding low clutch piston retainer (return spring) when installing snap ring.
 <p>B1H0068</p>	499577000	GAUGE	Used for measuring the transmission case mating surface to the reduction gear end surface.
 <p>G1H0207</p>	498937110	HOLDER	Used for removing and installing drive pinion lock nut.
 <p>B1H0284</p>	499737000	PULLER	Used for removing driven gear assembly.
 <p>B1H0281</p>	499737100	PULLER SET	Used for removing reduction drive gear assembly.

**SPECIAL TOOLS****[G300] 1-6**

3. Automatic Transmission and Differential Tools

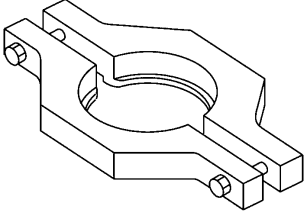
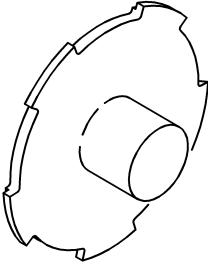
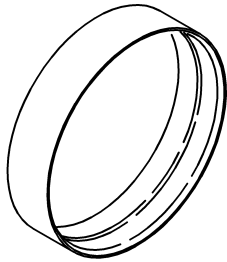
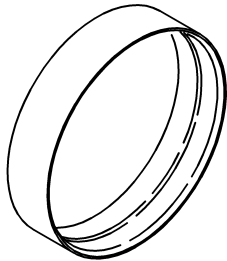
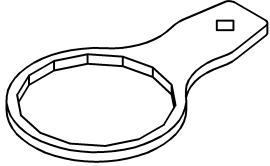
ILLUSTRATION	TOOL NUMBER	DESCRIPTION	REMARKS
 <p>G1H0157</p>	498077600	REMOVER	Used for removing ball bearing.
 <p>B1H0282</p>	498677100	COMPRESSOR	Used for installing 2-4 brake snap ring.
 <p>B1H0283</p>	498437000	HIGH CLUTCH PISTON GUIDE	Used for installing high clutch piston.
 <p>B1H0283</p>	498437100	LOW CLUTCH PISTON GUIDE	Used for installing low clutch piston.
 <p>B1H0289</p>	498545400	FILTER WRENCH	Used for removing and installing ATF filter.