

22. Fuel Tank

A: REMOVAL

WARNING:

- Place “NO FIRE” signs near the working area.
- Be careful not to spill fuel on the floor.

- 1) Set the vehicle on the lift.
- 2) Release the fuel pressure. <Ref. to FU(H4DOTC)-46, RELEASING OF FUEL PRESSURE, OPERATION, Fuel.>
- 3) Drain the fuel from the fuel tank. <Ref. to FU(H4DOTC)-46, DRAINING FUEL, OPERATION, Fuel.>
- 4) Remove the rear seat.
- 5) Disconnect the connector (A) of fuel tank cord to the rear harness.
- 6) Push the grommet (B) which holds the fuel tank cond on the floor panel into under the body.

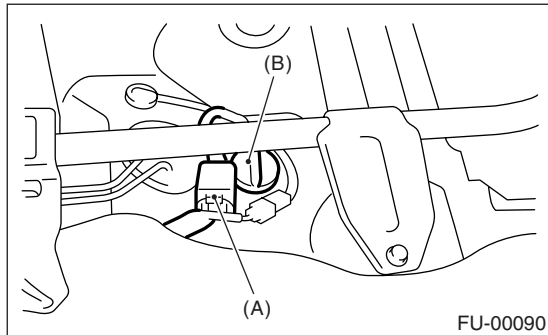

- 7) Remove the rear crossmember. <Ref. to RS-18, REMOVAL, Rear Crossmember.>
- 8) Loosen the clamp, and disconnect the evaporation hose from the canister.

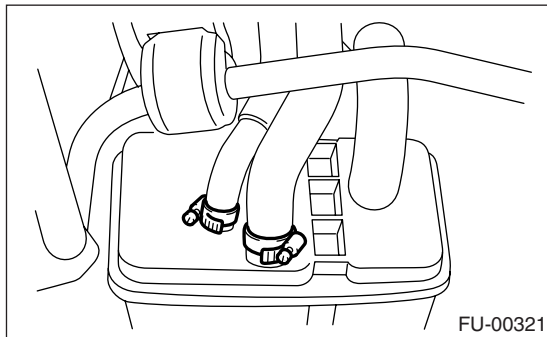

- 9) Disconnect the connector from the pressure control solenoid valve.

- 10) Disconnect the connector from the drain valve.

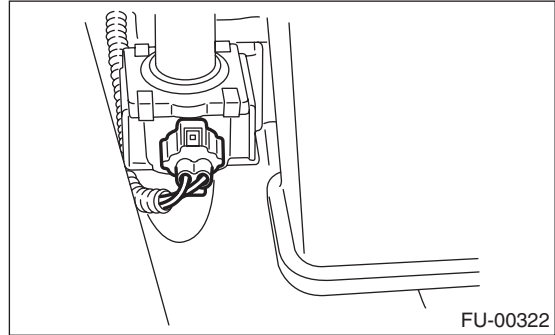

- 11) Loosen the clamp and disconnect the fuel filler hose (A) and evaporation hose (B) from the fuel filler pipe.

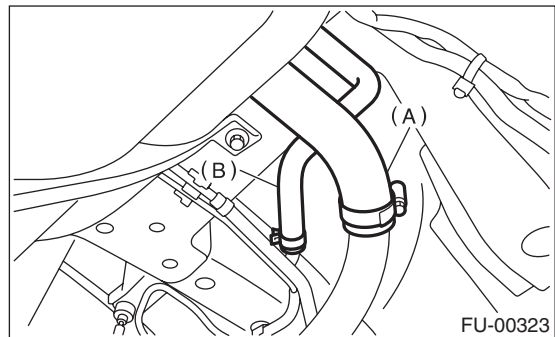

- 12) Move the clips, and disconnect the quick connector. <Ref. to FU(H4DOTC)-63, REMOVAL, Fuel Delivery, Return and Evaporation Lines.>
- 13) Disconnect the fuel hoses.

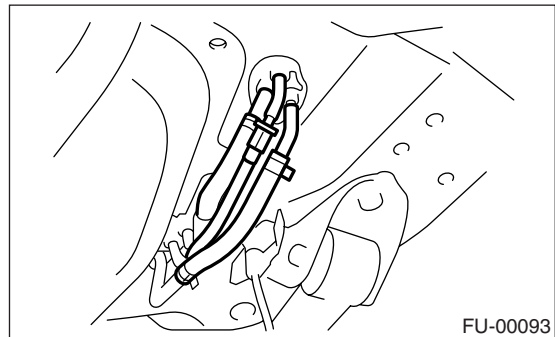

FUEL TANK

FUEL INJECTION (FUEL SYSTEMS)

14) Support the fuel tank with transmission jack, remove the bolts from bands and dismount the fuel tank from the vehicle.

WARNING:

A helper is required to perform this work.

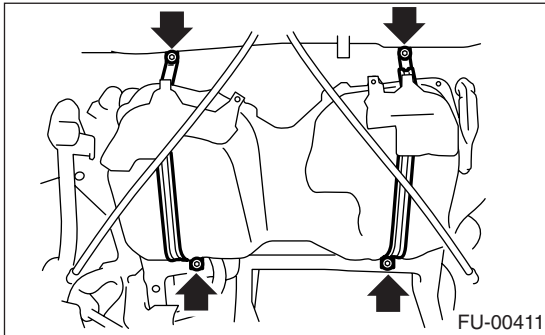

B: INSTALLATION

1) Support the fuel tank with transmission jack and push the fuel tank harness into access hole with grommet.

2) Set the fuel tank and temporarily tighten the bolts of fuel tank bands.

WARNING:

A helper is required to perform this work.

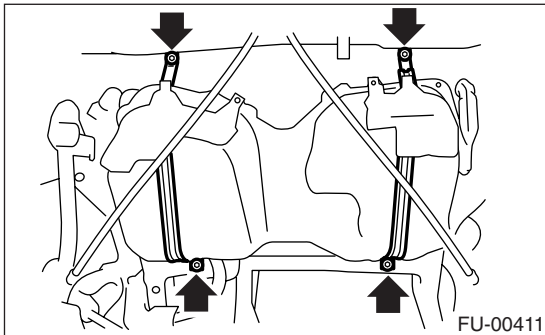

3) Connect the fuel filler hose (A) and air vent hose (B).

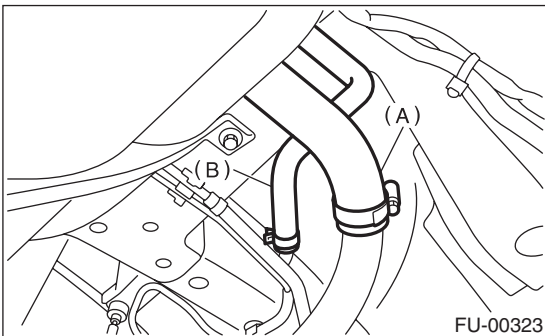

4) Connect the fuel hoses, and hold them with clips and quick connector. <Ref. to FU(H4DOTC)-63, REMOVAL, Fuel Delivery, Return and Evaporation Lines.>

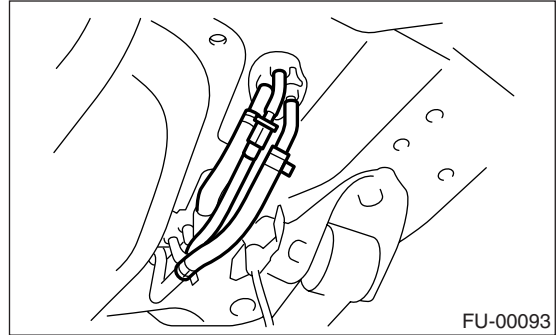

5) Connect the connector to the drain valve.

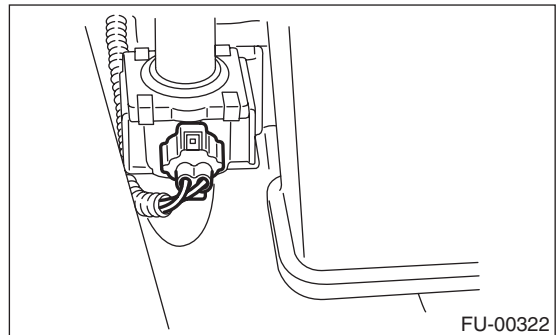

6) Connect the connector to the pressure control solenoid valve.

7) Connect the evaporation hose to the canister, and hold them clamp.

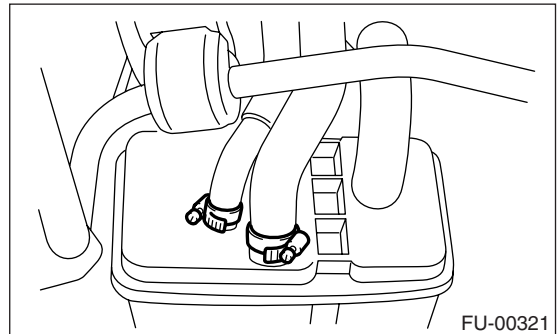

8) Tighten the band mounting bolts.

Tightening torque:

33 N·m (3.4 kgf·m, 25 ft·lb)

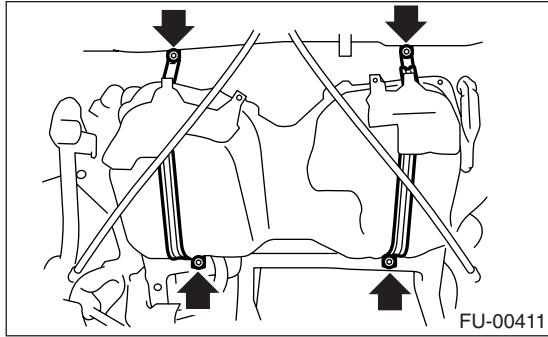

9) Install the rear crossmember. <Ref. to RS-18, INSTALLATION, Rear Crossmember.>

10) Connect the connectors (A) to the fuel tank cord and plug the service hole with grommet (B).

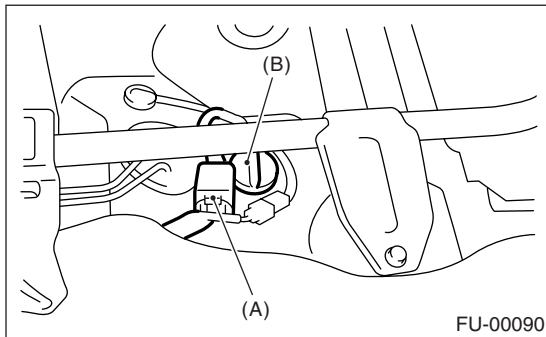

11) Set the rear seat and floor mat.

12) Connect the connector to the fuel pump relay.

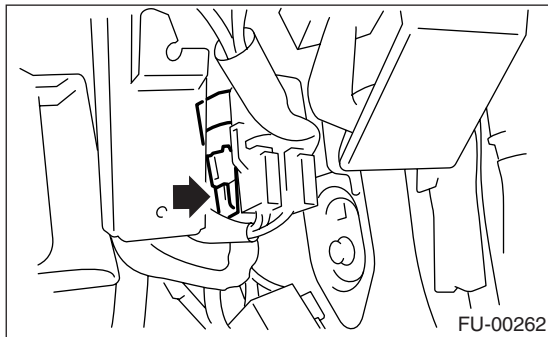

C: INSPECTION

- 1) Make sure there are no cracks, holes, or other damage on the fuel tank.
- 2) Make sure that the fuel hoses and fuel pipes are not cracked and that connections are tight.