

ENGINE COOLANT TEMPERATURE GAUGE SYSTEM

WIRING SYSTEM

17.Engine Coolant Temperature Gauge System

A: WIRING DIAGRAM

C/TEMP-01

C/TEMP-01

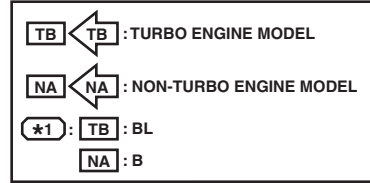
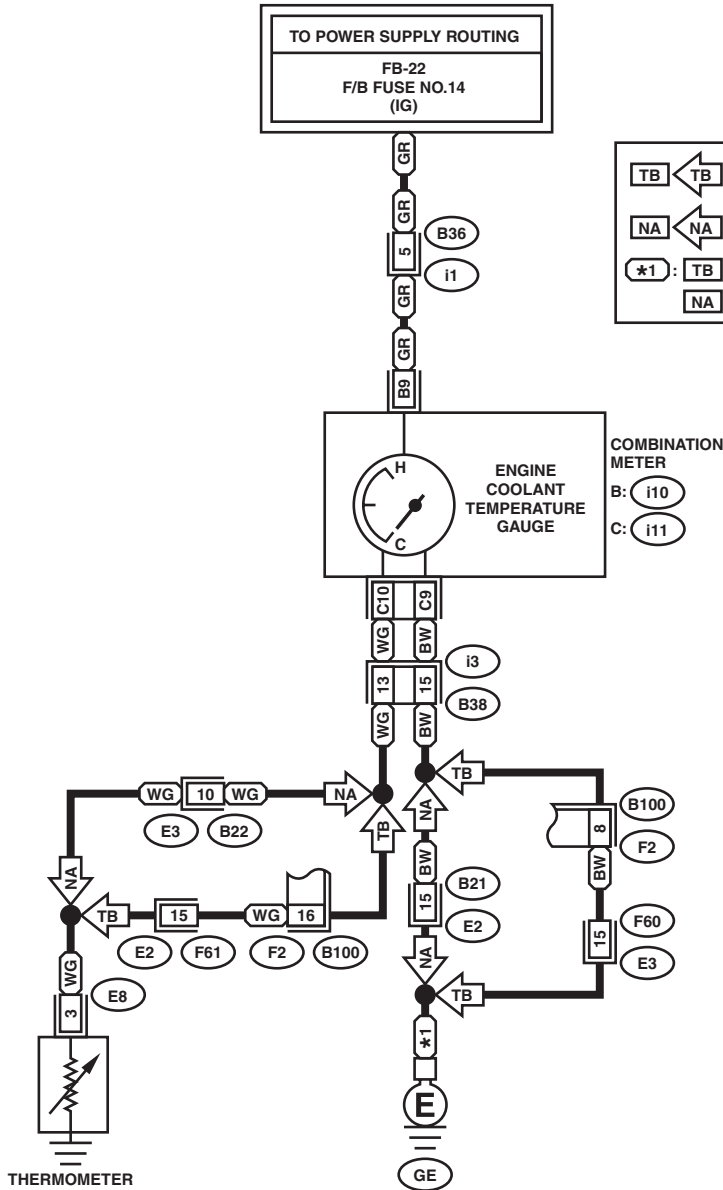

E8 (LIGHT GRAY)



C: i11 (GREEN)

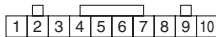

B21 (BROWN)

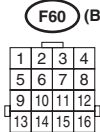

F60 (BROWN)

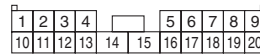

F2 (BLUE)

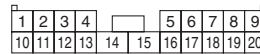

B22 (LIGHT GRAY)

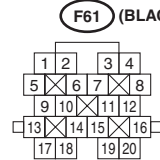

F61 (BLACK)

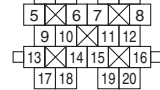

B36

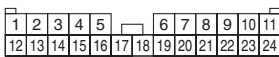

B: i10 (GREEN)

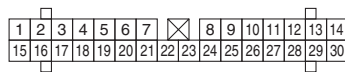

B38

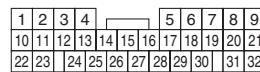

WI-03035