

7. AT Shift Lock Control System

A: WIRING DIAGRAM

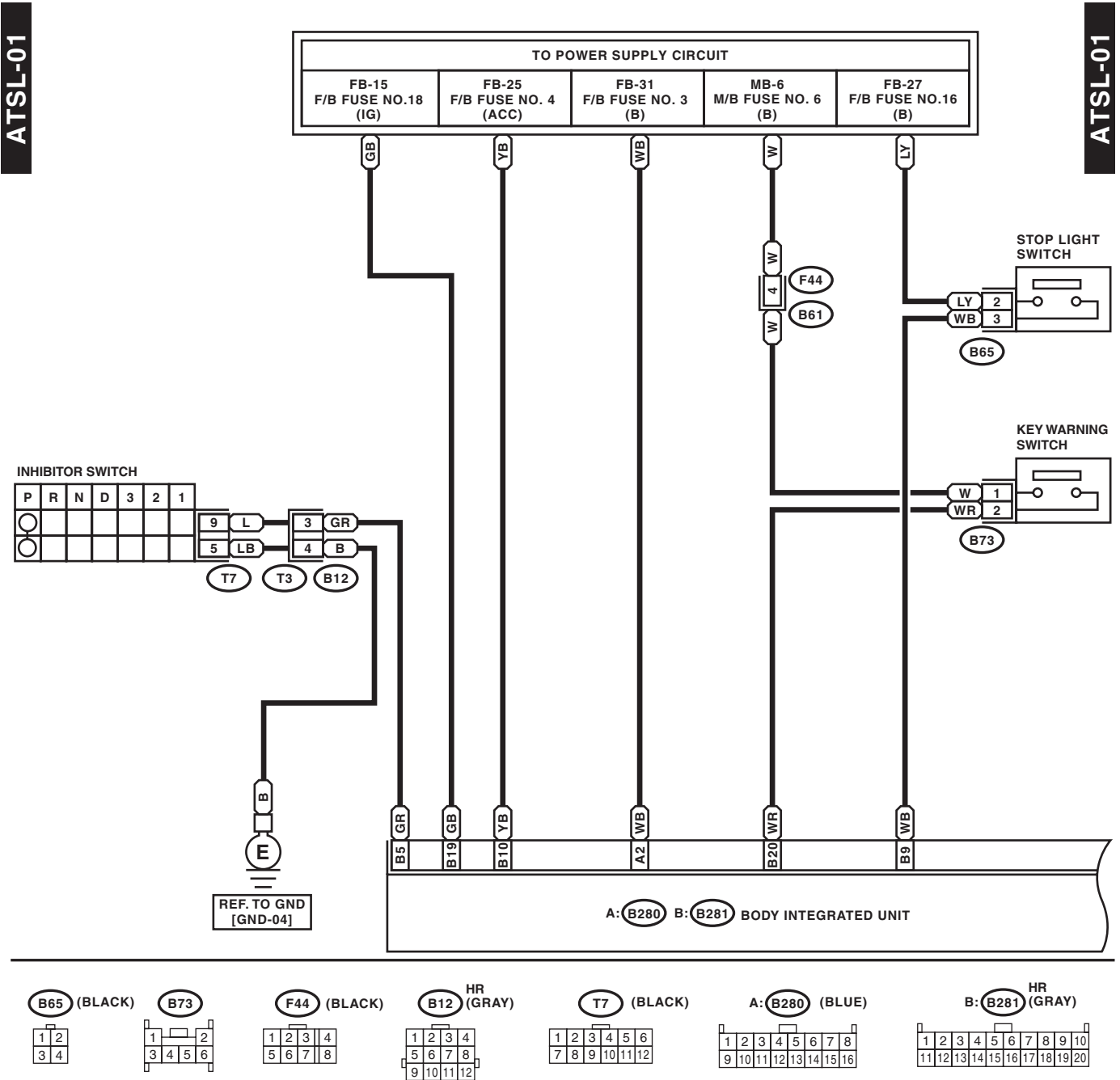

AT Shift Lock Control System

WIRING SYSTEM

ATSL-02

ATSL-02

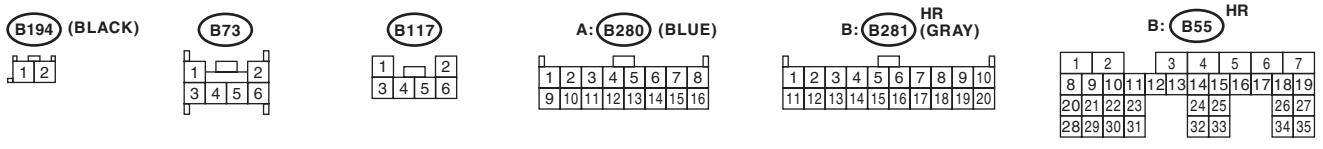
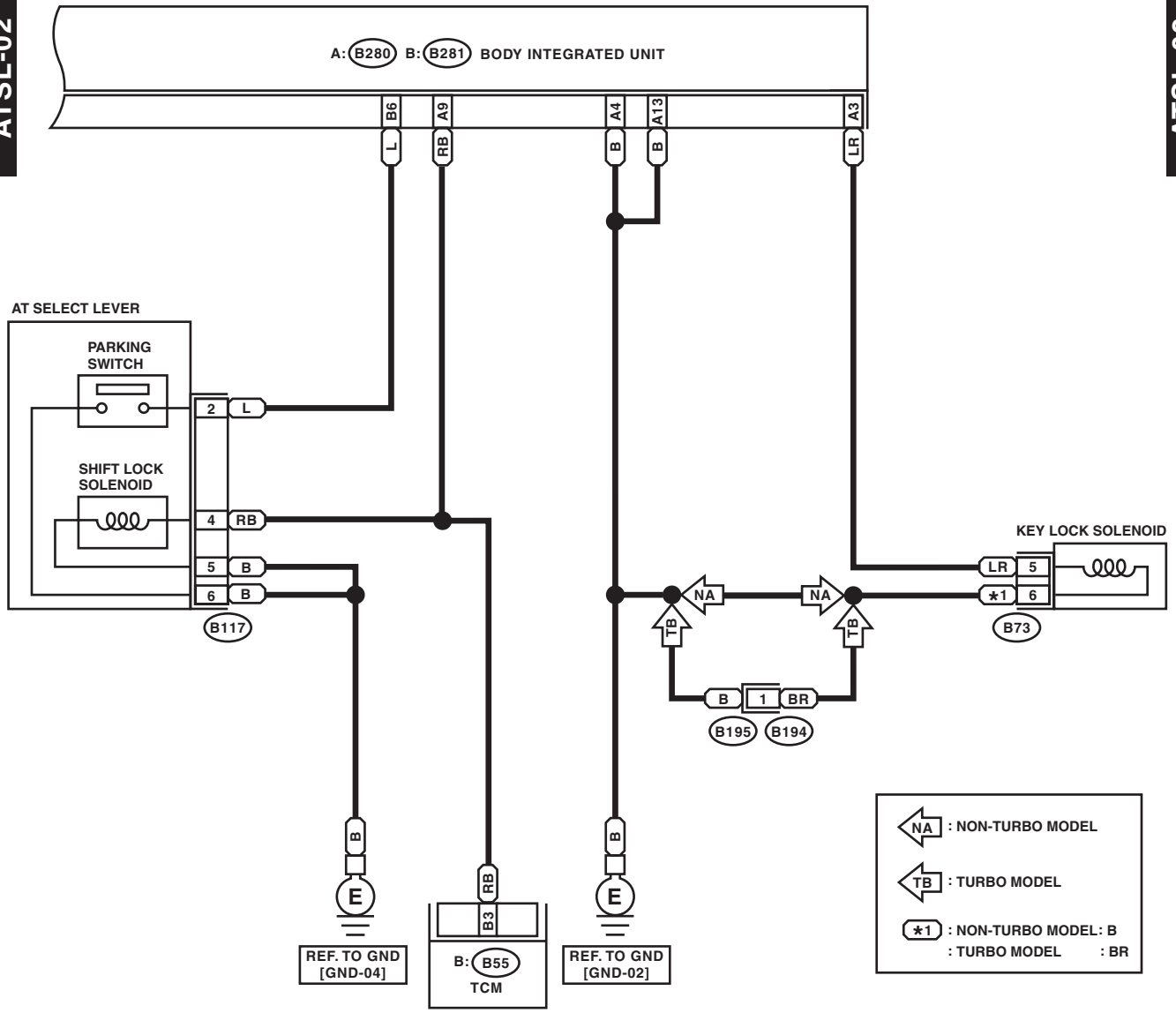

WI-15009