

8. Anti-Lock Brake System

A: WIRING DIAGRAM

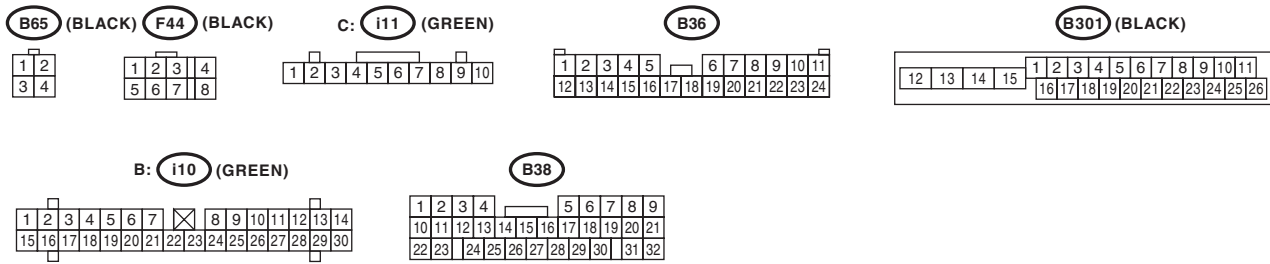
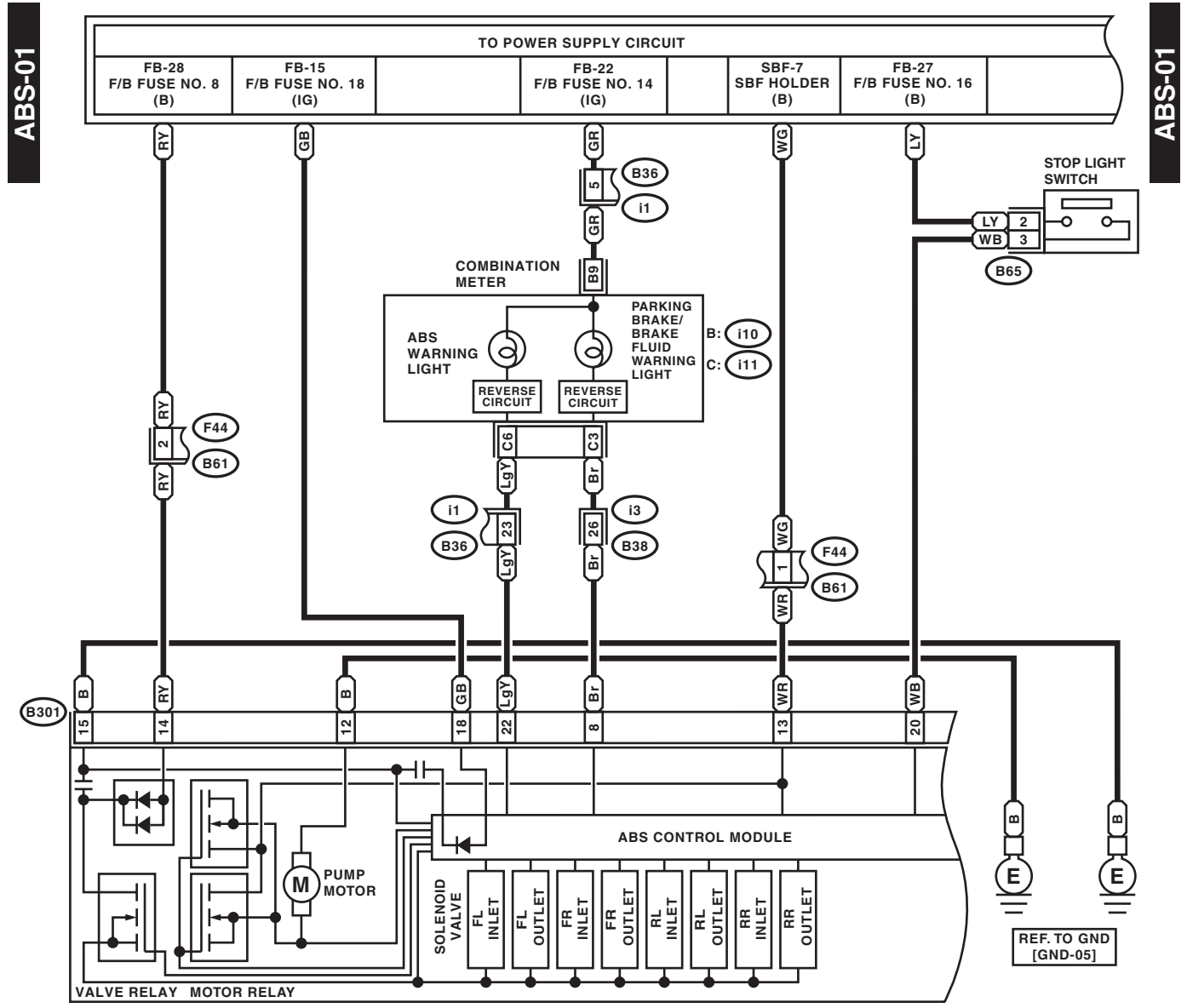

WI-15250

Anti-Lock Brake System

WIRING SYSTEM

ABS-02

ABS-02

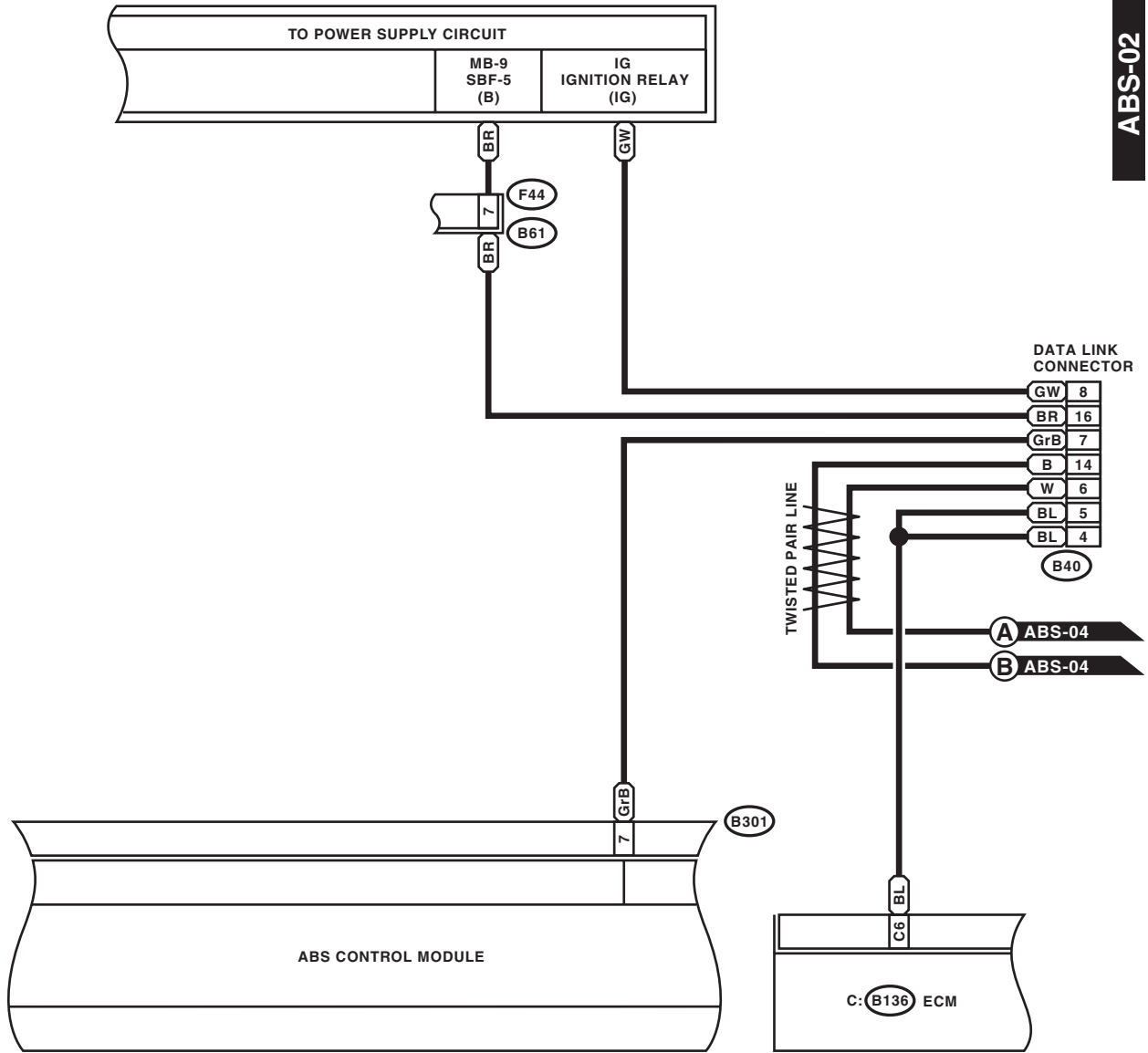

F44 (BLACK)

1	2	3	4
5	6	7	8

B40 (BLACK)

1	2	3	4	5	6	7	8
9	10	11	12	13	14	15	16

B301 (BLACK)

12	13	14	15	1	2	3	4	5	6	7	8	9	10	11
16	17	18	19	20	21	22	23	24	25	26				

C: B136 HR

1	2	3	4	5	6										
7	8	9	10	11	12	13	14	15	16						
17	18	19	20	21	22	23	24	25	26	27					
28	29	30									31	32	33	34	35

WI-15010

Anti-Lock Brake System

WIRING SYSTEM

ABS-03

ABS-03

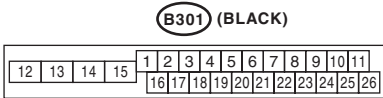
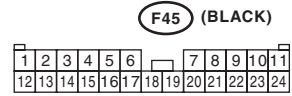
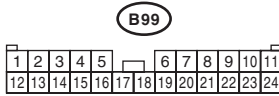
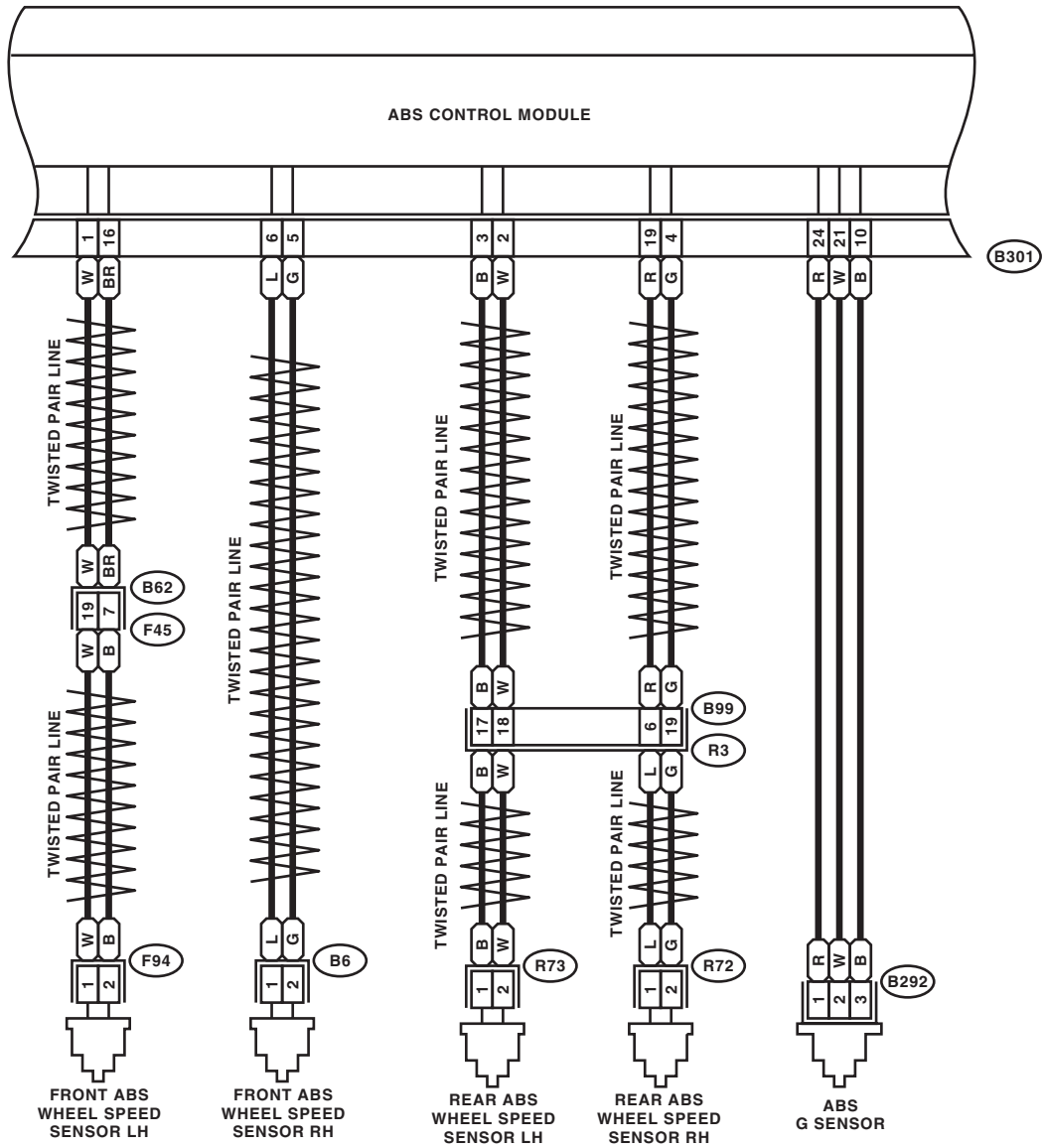

WI-15011

Anti-Lock Brake System

WIRING SYSTEM

ABS-04

ABS-04

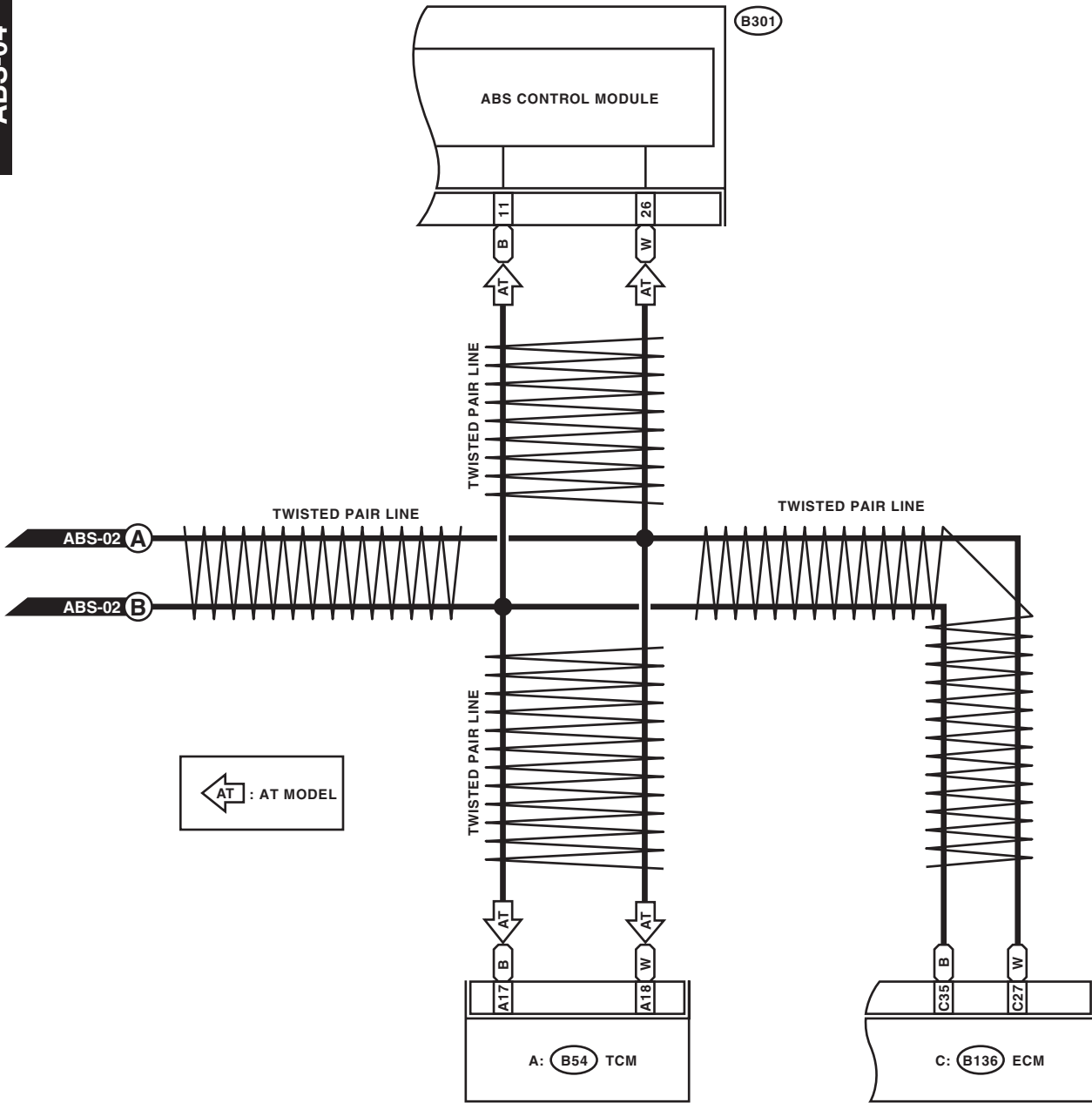

B301 (BLACK)

12	13	14	15	1	2	3	4	5	6	7	8	10	11	
				16	17	18	19	20	21	22	23	24	25	26

A: B54 HR

C: B136 HR

1	2	3	4	5	6					
7	8	9	10	11	12	13	14	15	16	
17	18	19	20	21	22	23	24	25	26	27
28	29	30				31	32	33	34	35

WI-15012