

# Cruise Control System

## WIRING SYSTEM

### 14. Cruise Control System

#### A: WIRING DIAGRAM

##### 1. NON-TURBO MODEL

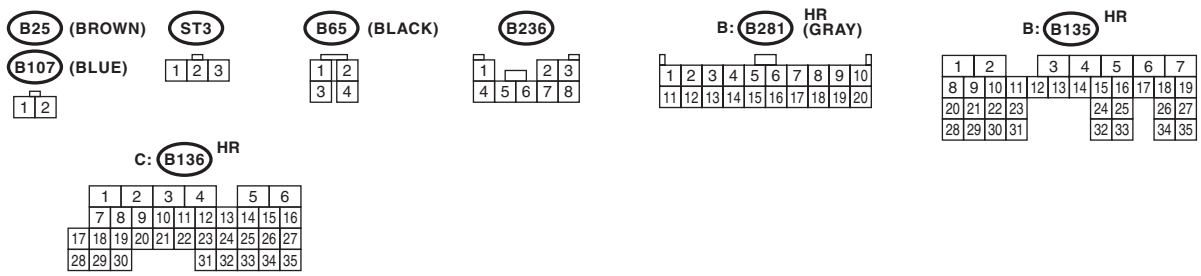
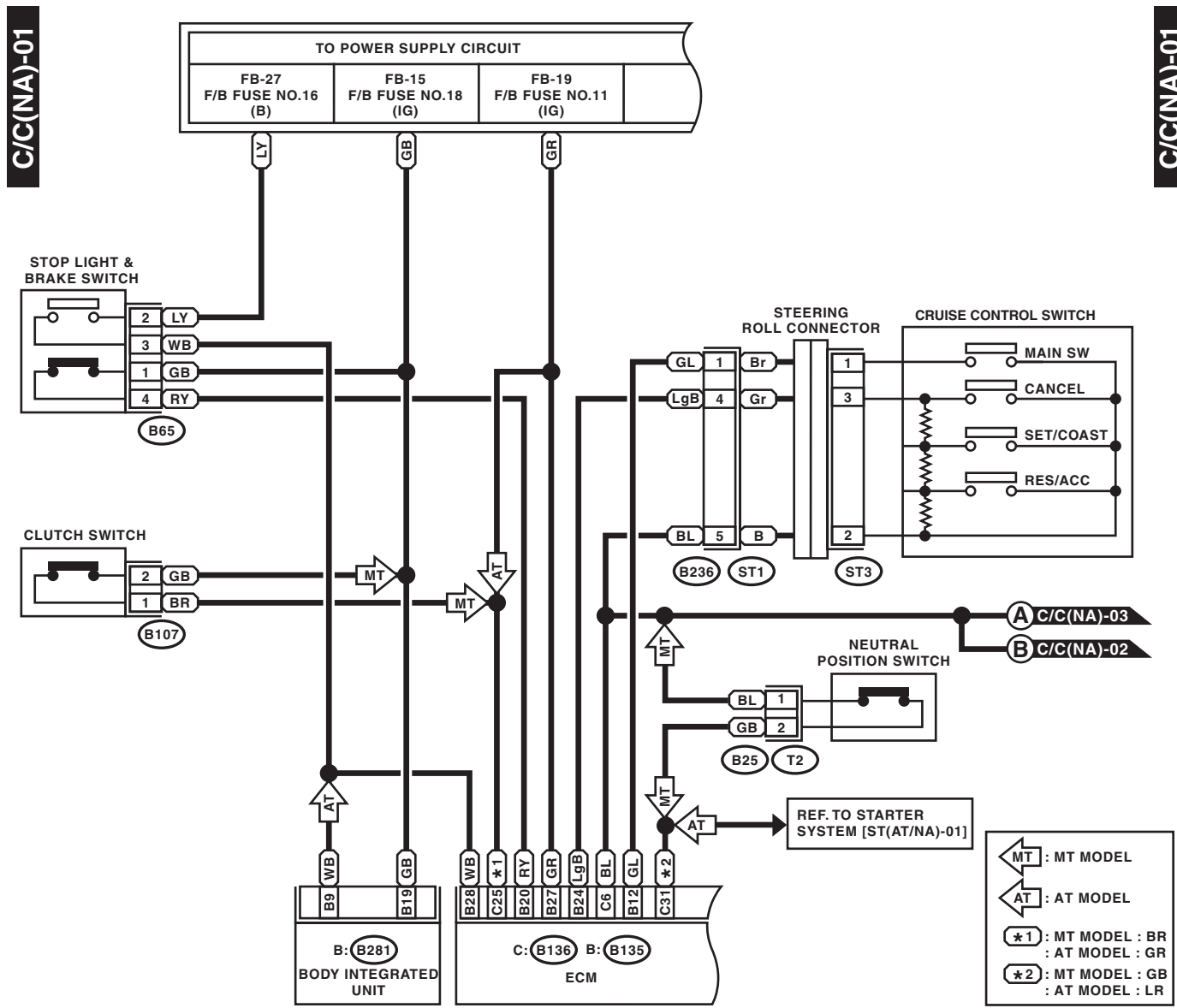

WI-15020

# Cruise Control System

WIRING SYSTEM

C/C(NA)-02

C/C(NA)-02

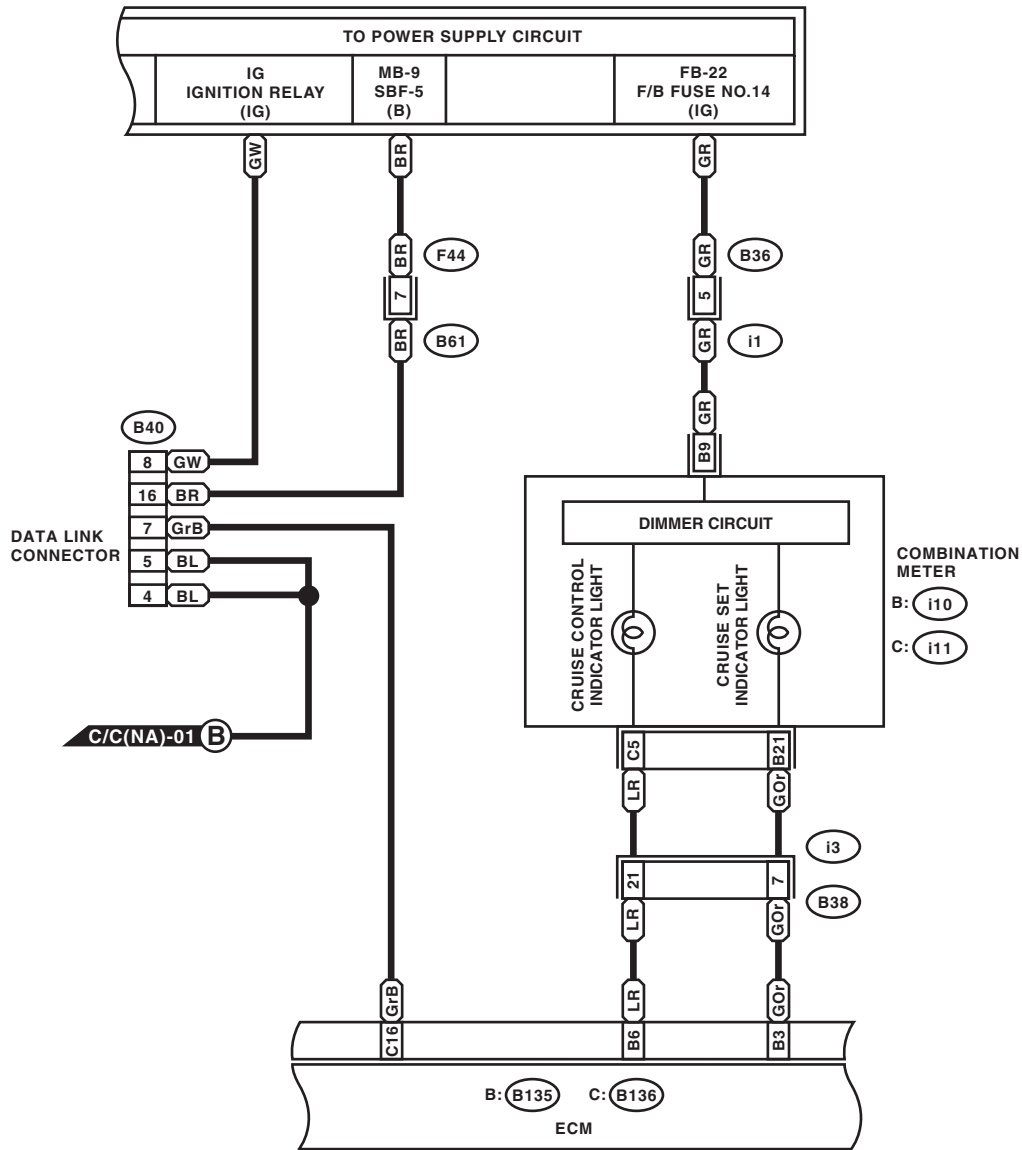

F44 (BLACK)



C: i11 (GREEN)

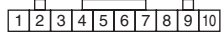

B40 (BLACK)



B36

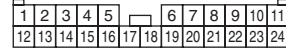

B: i10 (GREEN)

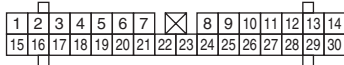

B38



B: B135 HR

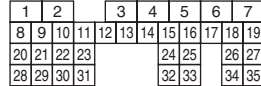

C: B136 HR

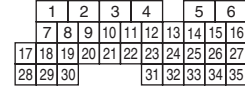

WI-15021

# Cruise Control System

## WIRING SYSTEM

C/C(NA)-03

C/C(NA)-03

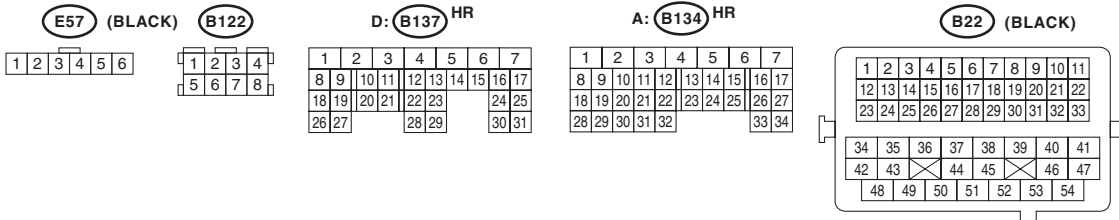
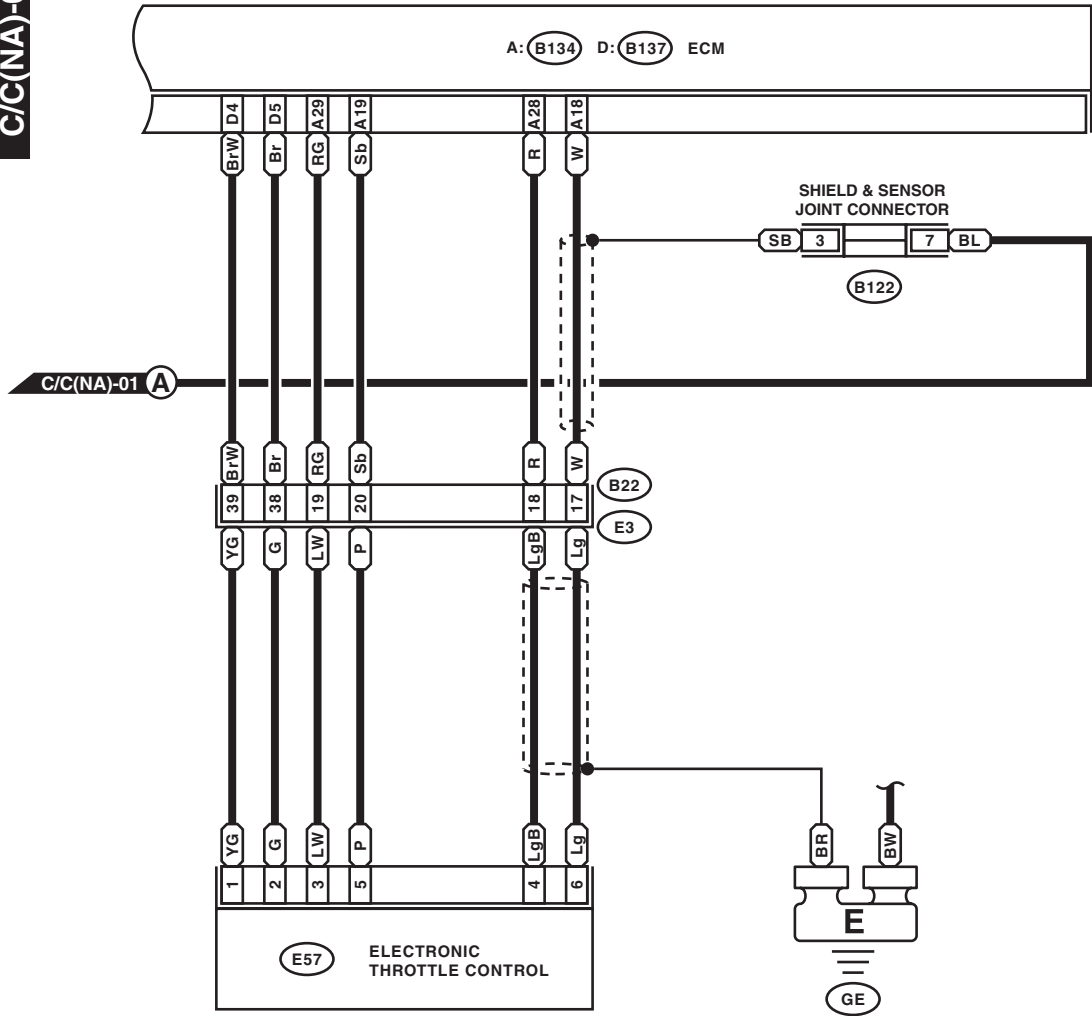

WI-15022

# Cruise Control System

WIRING SYSTEM

## 2. TURBO MODEL

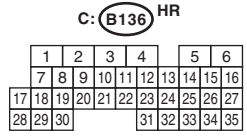
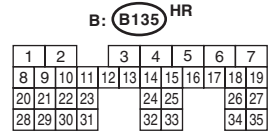
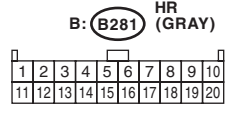
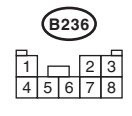
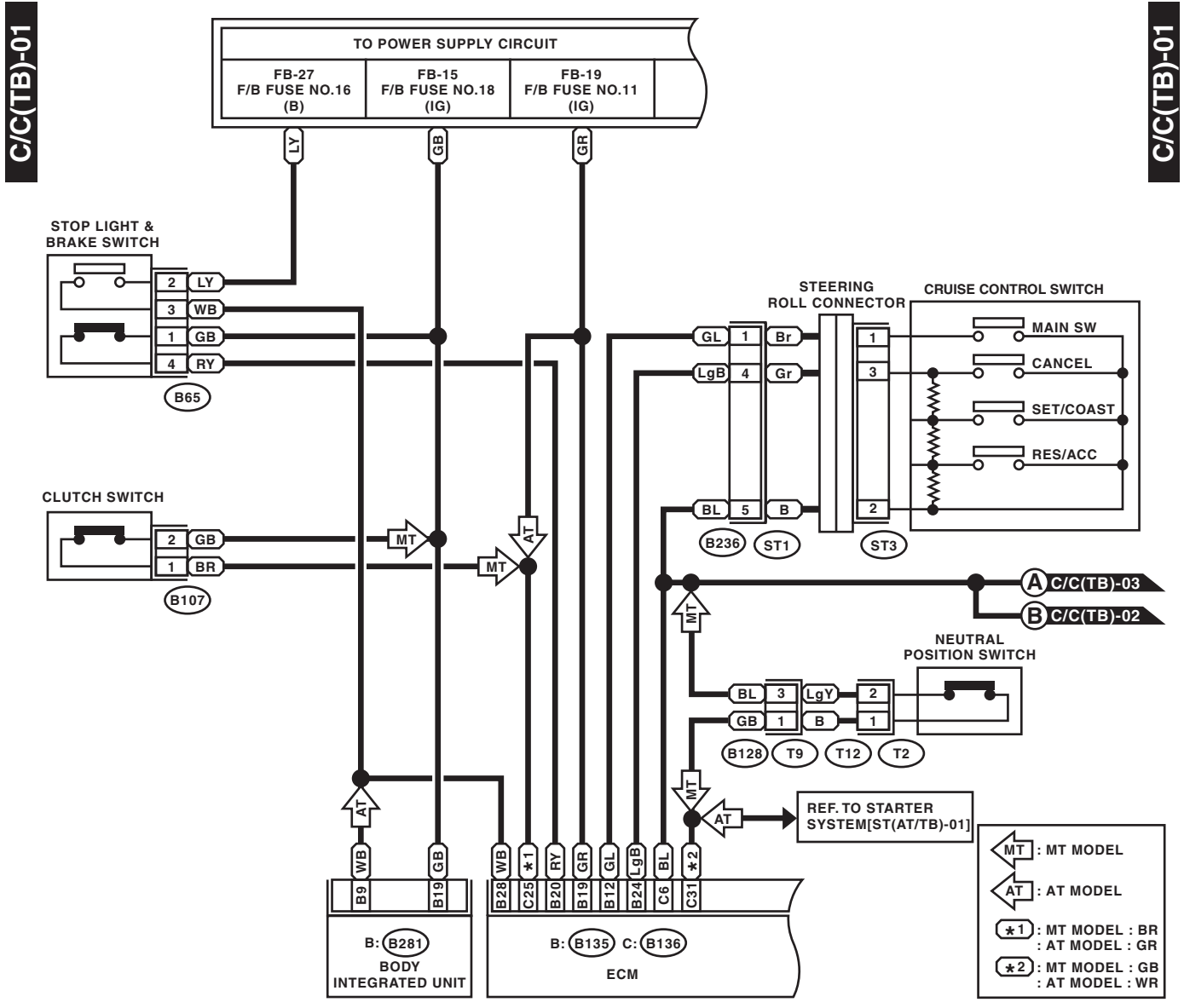

WI-15023

# Cruise Control System

WIRING SYSTEM

C/C(TB)-02

C/C(TB)-02

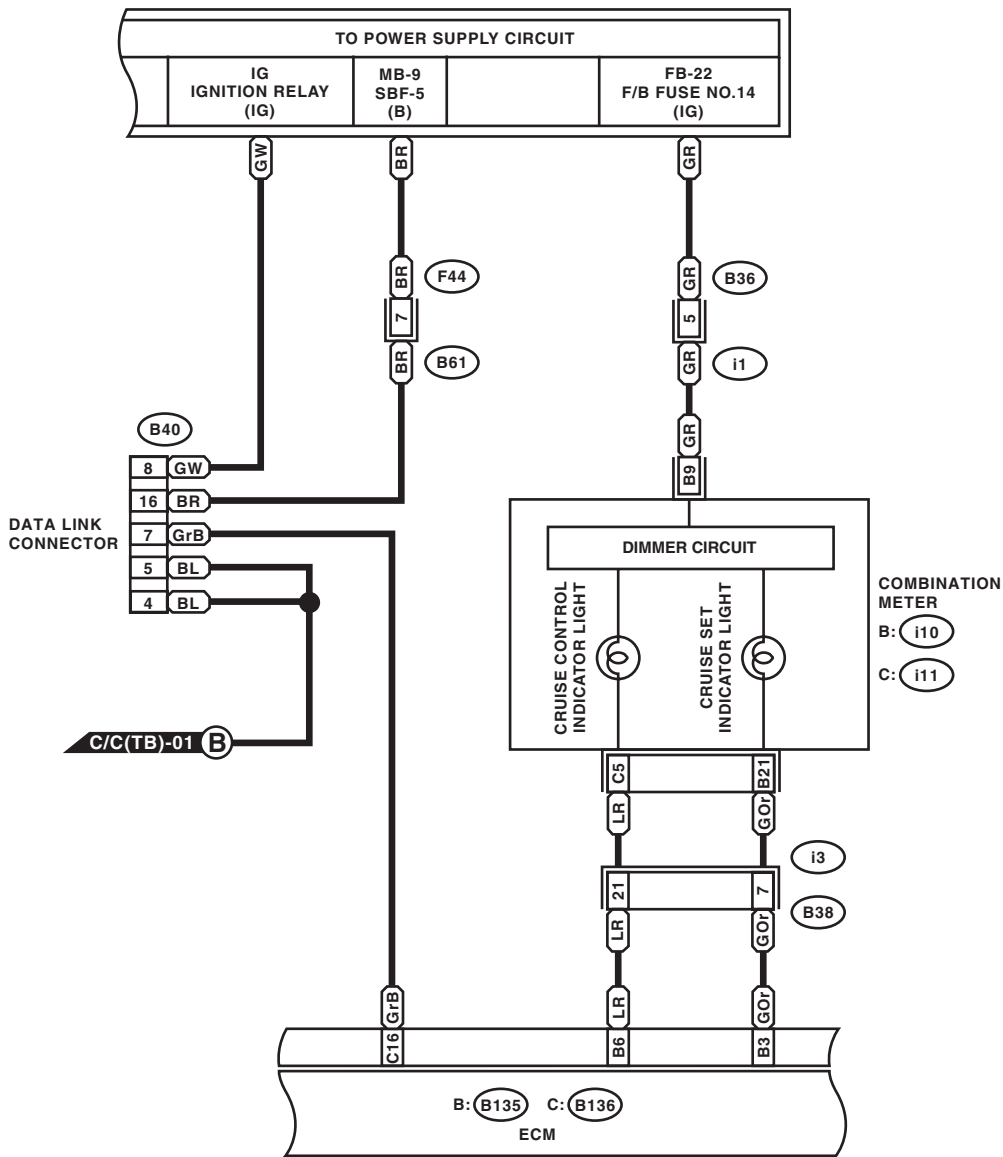

F44 (BLACK)



C: i11 (GREEN)

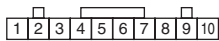

B40 (BLACK)

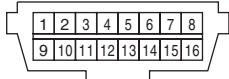

B36



B: i10 (GREEN)

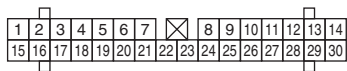

B38

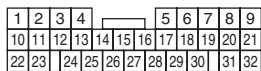

B: B135 HR

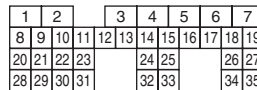

C: B136 HR

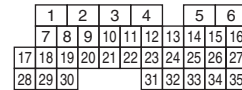

WI-15024

# Cruise Control System

WIRING SYSTEM

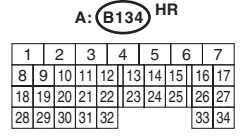
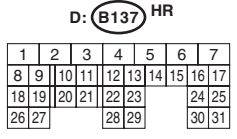
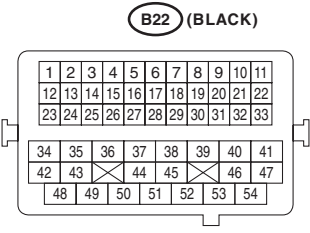
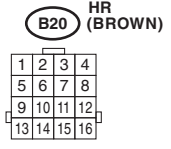
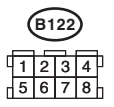
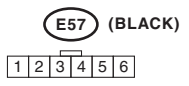
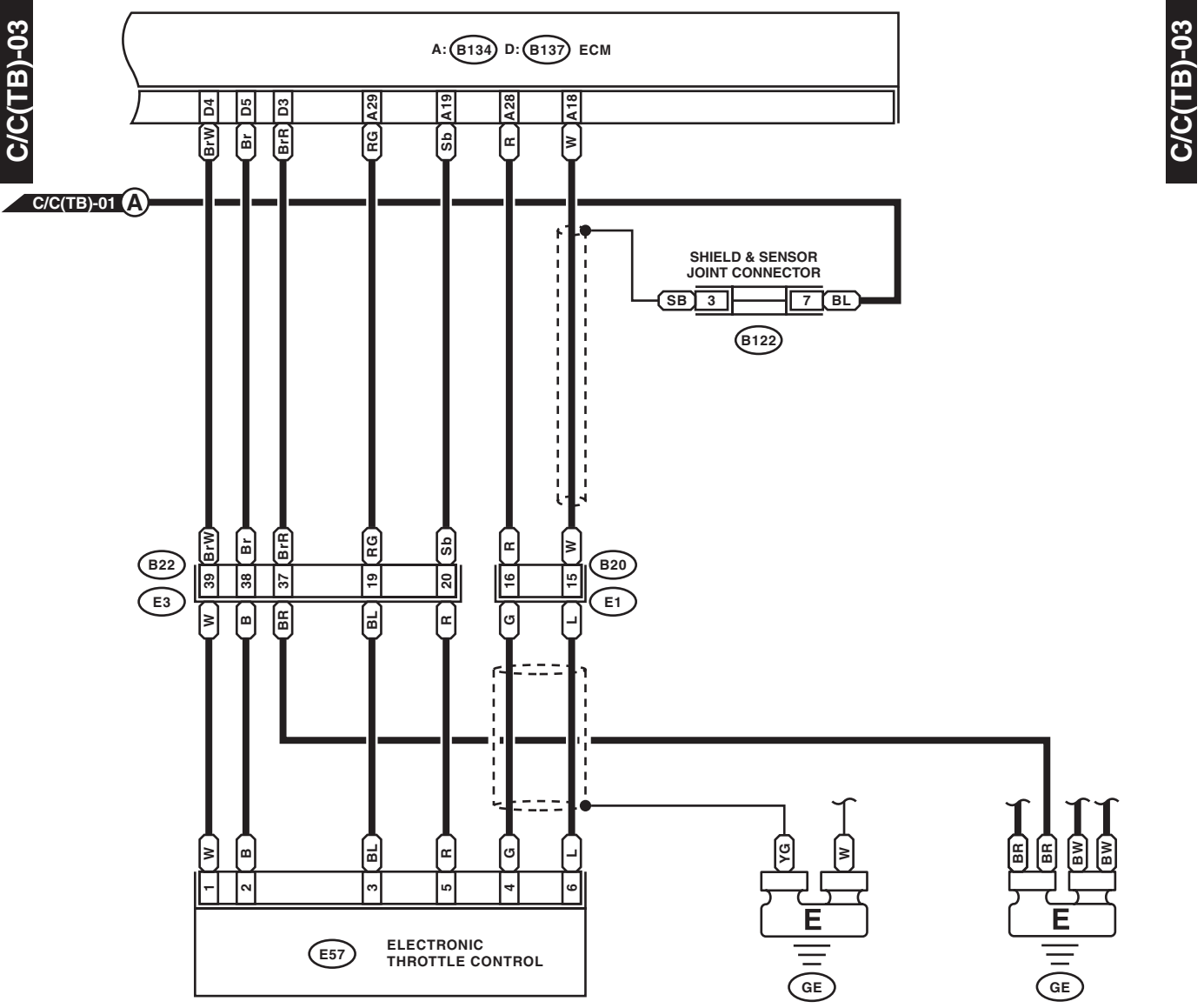

WI-15025