

5. Diagnostics Chart with Trouble Code

| Trouble code/Contents of troubles | | Memory function | Contents of diagnosis | Page |
|--|--------------------------|-----------------|--|------|
| 04 | | Provided. | 1) Airbag main harness circuit is shorted. 2) Airbag module harness (Ps) circuit is shorted. 3) Airbag control module is faulty. | 16 |
| 11 | | Provided. | 1) Airbag control module is faulty. 2) Airbag main harness circuit is open. 3) Fuse No. 8 is blown. 4) Body harness circuit is open. | 17 |
| 12 | | Provided. | 1) Airbag main harness circuit is open. 2) Airbag module harness (Dr) circuit is open. 3) Roll connector circuit is open. 4) Airbag control module is faulty. | 19 |
| 13 | | Provided. | 1) Airbag main harness circuit is shorted. 2) Airbag module harness (Dr) is shorted. 3) Roll connector circuit is shorted. 4) Airbag control module is faulty. | 20 |
| 14 | | Not provided. | 1) (AB9) and (AB10) are not connected properly. 2) (AB2) and (AB7) are not connected properly. 3) (AB3) and (AB8) are not connected properly. 4) (AB6) is not connected properly to airbag control module. | 21 |
| 21 | | Provided. | Airbag control module is faulty. | 23 |
| 22 | | Provided. | 1) Airbag main harness circuit is open. 2) Airbag module harness (Ps) circuit is open. 3) Airbag control module is faulty. | 24 |
| 34 | | Provided. | 1) Airbag main harness circuit (Ps) is shorted to power supply. 2) Airbag module harness (Ps) is shorted to power supply. 3) Airbag control module is faulty. | 25 |
| 41 | | Provided. | 1) Airbag main harness circuit (Dr) is shorted to ground. 2) Airbag module harness circuit (Dr) is shorted to ground. 3) Roll connector circuit is shorted to ground. 4) Airbag control module is faulty. | 26 |
| 42 | | Provided. | 1) Airbag main harness circuit (Ps) is shorted to ground. 2) Airbag module harness circuit (Ps) is shorted to ground. 3) Airbag control module is faulty. | 27 |
| 43 | | Provided. | 1) Airbag main harness circuit (Dr) is shorted to power supply. 2) Airbag module harness (Dr) is shorted to power supply. 3) Roll connector is shorted to power supply. 4) Airbag control module is faulty. | 28 |
| Airbag warning light remains on. | | Not provided. | 1) Airbag warning light is faulty. 2) Airbag control module to airbag warning light harness circuit is shorted or open. 3) Grounding circuit is faulty. 4) Airbag control module is faulty. 5) (AB1) and (B39) are not connected properly. | 29 |
| Airbag warning light remains off. | | Not provided. | 1) Fuse No. 15 is blown. 2) Body harness circuit is open. 3) Airbag warning light is faulty. 4) Airbag main harness is faulty. 5) Airbag control module is faulty. | 32 |
| Warning light indicates trouble code, then normality code. | Flashing trouble code. | Provided. | Airbag system component parts are faulty. | 34 |
| | Flashing normality code. | Not provided. | 1) Airbag connector is faulty. 2) Fuse No. 16 is blown. 3) Airbag main harness is faulty. 4) Airbag control module is faulty. 5) Body harness is faulty. | 37 |

NOTE: Dr: Driver side Ps: Passenger side

A: TROUBLE CODE 04**DIAGNOSIS:**

- Airbag main harness circuit is shorted.
- Airbag module harness (Passenger) circuit is shorted.
- Airbag control module is faulty.

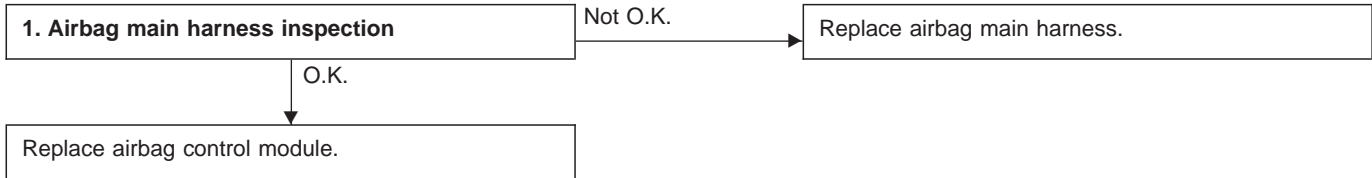
**CAUTION:**

Before performing diagnostics on airbag system, turn ignition switch "OFF", disconnect battery ground cable and then wait at least 20 seconds.

After 20 seconds elapse, remove instrument panel lower cover, and disconnect (AB3) and (AB8), (AB9) and (AB10).

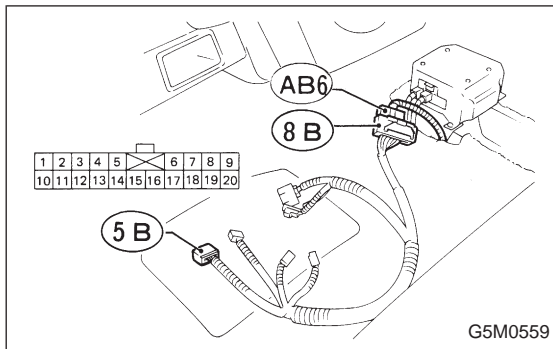
**1. AIRBAG MAIN HARNESS INSPECTION**

1) Disconnect connector (AB6) from airbag control module <Ref. to 5-5 [W6A0].>, and connect (AB6) to test harness-B connector (8B).

2) Measure resistance between test harness-B connector (5B) terminals.

(5B) Terminal / Specified resistance:
No. 6 — No. 7 / 10 kΩ, or more

B: TROUBLE CODE 11

DIAGNOSIS:

- Airbag control module is faulty.
- Airbag main harness circuit is open.
- Fuse No. 8 is blown.
- Body harness circuit is open.



CAUTION:

Before performing diagnostics on airbag system, turn ignition switch “OFF”, disconnect battery ground cable and then wait at least 20 seconds.

After 20 seconds elapse, remove instrument panel lower cover, and disconnect (AB3) and (AB8).

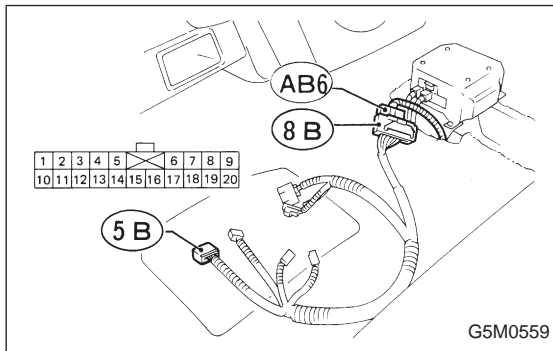

Test harness B-PN98299PA010

1. AIRBAG CONTROL MODULE INSPECTION

1) Disconnect connector (AB6) from airbag control module <Ref. to 5-5 [W5A0].> and connect it to test harness-B connector (8B).

2) Connect battery ground cable and turn ignition switch “ON”. (engine off)

3) Measure voltage across connector (5B) terminal and body.

(5B) Terminal / Specified voltage:
No. 2 — Body / 10 V, or more

2. AIRBAG MAIN HARNESS INSPECTION

- 1) Go to step 2) below after performing diagnostics on airbag system as per flowchart under "1. Airbag Control Module Inspection" previously outlined.
- 2) Turn ignition switch "OFF", disconnect battery ground terminal and then wait at least 20 seconds.

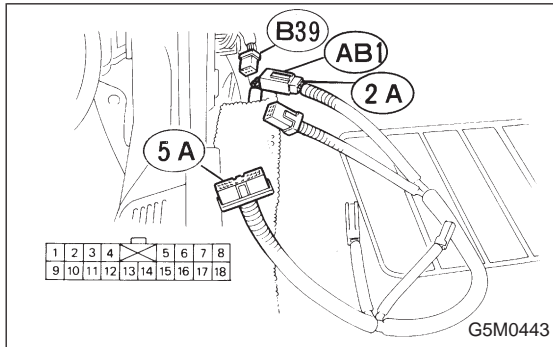

Test harness A-PN98299PA000

- 3) Disconnect bulk harness connector (B39) from connector (AB1) at front lower pillar, and connect connector (AB1) to test harness-A connector (2A).

- 4) Measure resistance between test harness-A connector (5A) terminal and test harness-B connector (5B) terminal.

Connector & terminal / Specified resistance:

(5A) No. 1 — (5B) No. 2 / 10 Ω, or less

- 5) Measure resistance between terminals of connectors (5A) and (5B).

(5A) Terminal / Specified resistance:

No. 1 — Body / 10 kΩ, or more

(5B) Terminal / Specified resistance:

No. 2 — Body / 10 kΩ, or more

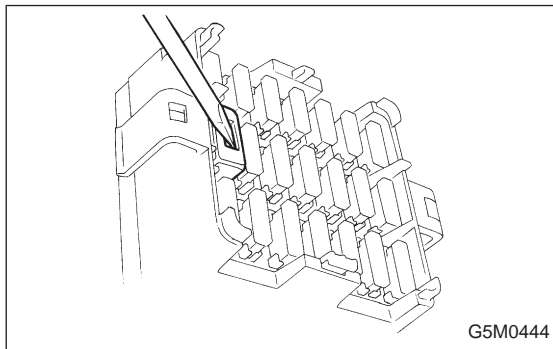

3. FUSE NO. 8 INSPECTION

- 1) Turn ignition switch "OFF", and remove airbag fuse protector.

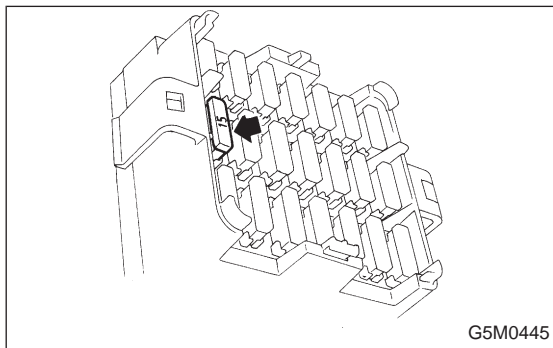

- 2) Remove and visually check fuse No. 8.

C: TROUBLE CODE 12

DIAGNOSIS:

- Airbag main harness circuit is open.
- Airbag module harness circuit is open.
- Roll connector circuit is open.
- Airbag control module is faulty.

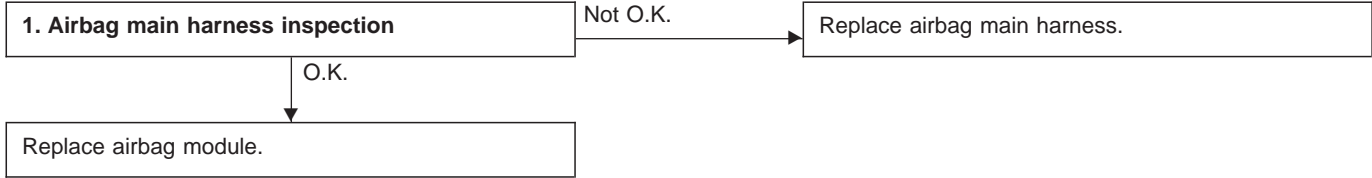

CAUTION:

Before performing diagnostics on airbag system, turn ignition switch "OFF", disconnect battery ground cable and then wait at least 20 seconds.

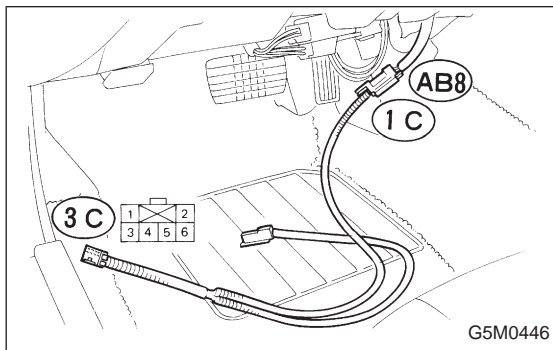

1. AIRBAG MAIN HARNESS INSPECTION

1) Remove lower cover panel <Ref. to 5-4 [W1A0].>, and connect connector (AB8) below steering column to test harness-C connector (1C).

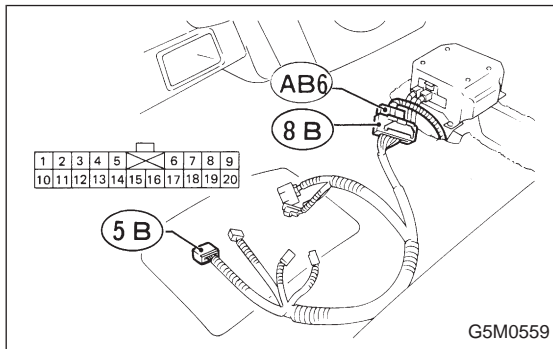

2) Disconnect connector (AB6) <Ref. to 5-5 [W5A0].> from airbag control module, and connect it to test harness-B connector (8B) terminal.

3) Measure resistance between test harness-B connector (5B) and test harness-C connector (3C) terminals.

Connector & terminal / Specified resistance:
 (5B) No. 14 — (3C) No. 2 / 10 Ω, or less
 (5B) No. 1 — (3C) No. 3 / 10 Ω, or less

Test harness B-PN98299PA010
 Test harness C-PN98299PA020

D: TROUBLE CODE 13**DIAGNOSIS:**

- Airbag main harness circuit is shorted.
- Airbag module harness is shorted.
- Roll connector circuit is shorted.
- Airbag control module is faulty.

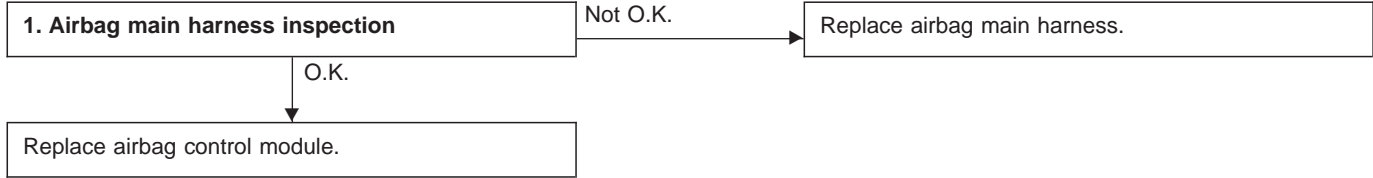
**CAUTION:**

Before performing diagnostics on airbag system, turn ignition switch "OFF", disconnect battery ground cable and then wait at least 20 seconds.

After 20 seconds elapse, remove instrument panel lower cover, and disconnect (AB3) and (AB8).

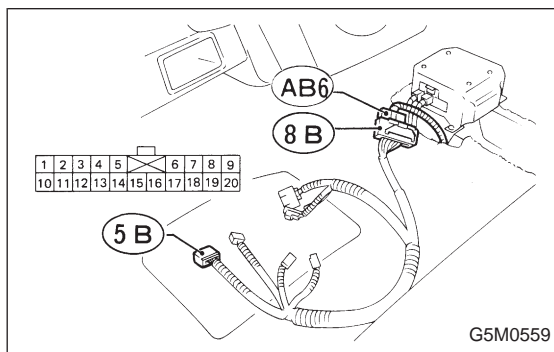
**1. AIRBAG MAIN HARNESS INSPECTION**

1) Disconnect connector (AB6) from airbag control module <Ref. to 5-5 [W5A0].>, and connect it to test harness-B connector (8B).

2) Measure resistance between test harness-B connector (5B) terminals.

(5B) Terminal / Specified resistance:

No. 1 — No. 14 / 10 kΩ, or more

Test harness B-PN98299PA010

E: TROUBLE CODE 14

DIAGNOSIS:

- (AB9) and (AB10) are not connected properly.
- (AB2) and (AB7) are not connected properly.
- (AB3) and (AB8) are not connected properly.
- (AB6) is not connected properly to airbag control module.

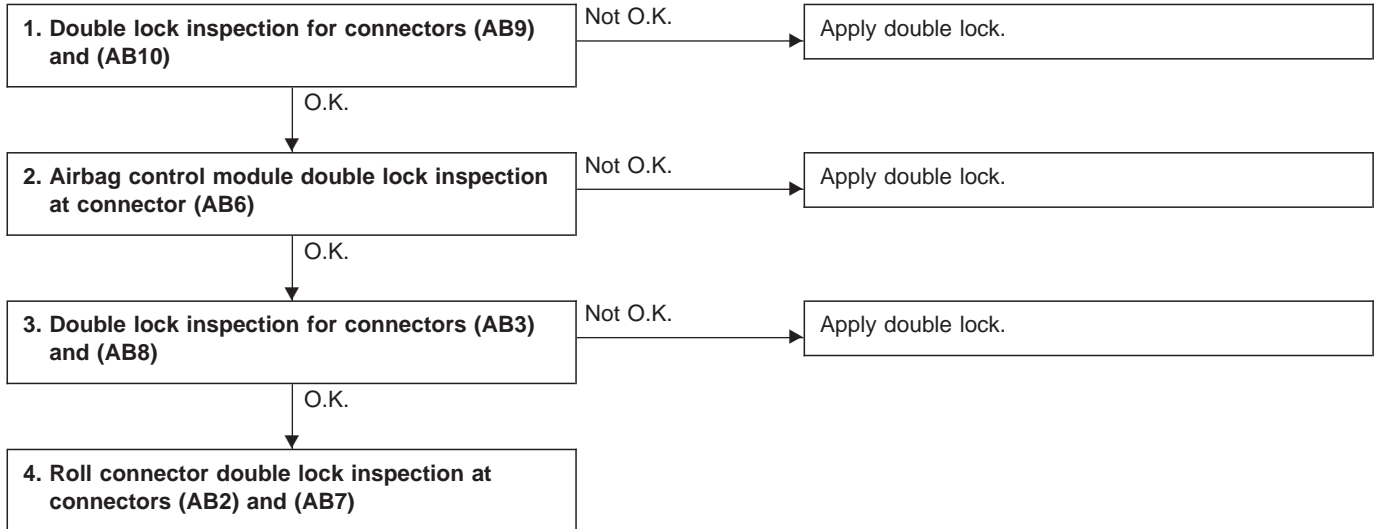

CAUTION:

Before performing diagnostics on airbag system, turn ignition switch "OFF", disconnect battery ground cable and then wait at least 20 seconds.

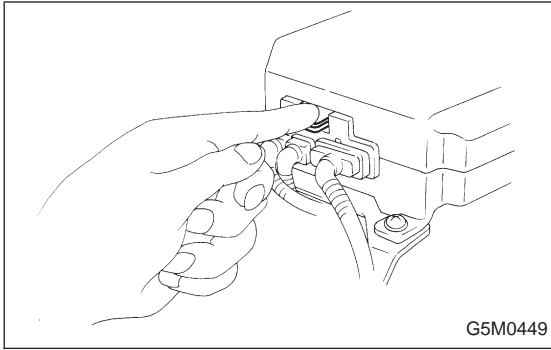

1. AIRBAG CONTROL MODULE DOUBLE LOCK INSPECTION AT CONNECTORS (AB4) (AB5) (AB6)

1) Check double lock of connectors (AB4) (AB5) (AB6) connected to airbag control module. <Ref. to 5-5 [W5A0].>

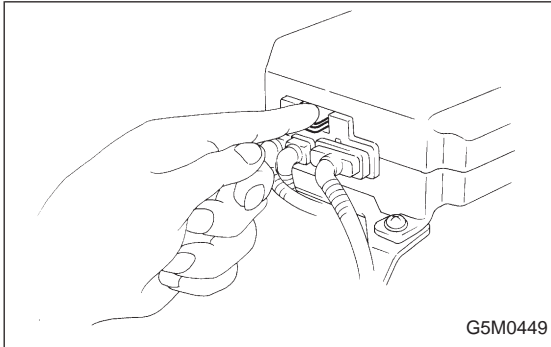

2. AIRBAG CONTROL MODULE DOUBLE LOCK INSPECTION AT CONNECTOR (AB6)

1) Check double lock of connector (AB6) connected to airbag control module. <Ref. to 5-5 [W5A0].>

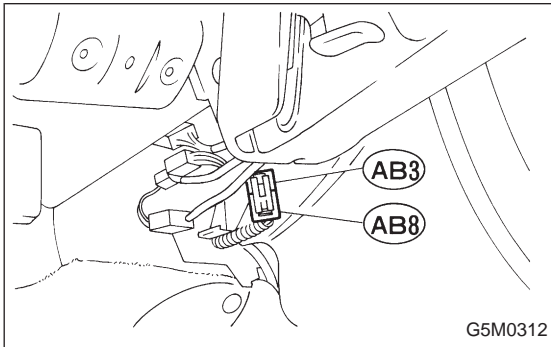

3. DOUBLE LOCK INSPECTION FOR CONNECTORS (AB3) AND (AB8) BELOW STEERING COLUMN

1) Remove lower cover panel. <Ref. to 5-4 [W1A0].>
 2) Check double lock of connectors (AB3) and (AB8) below steering column.

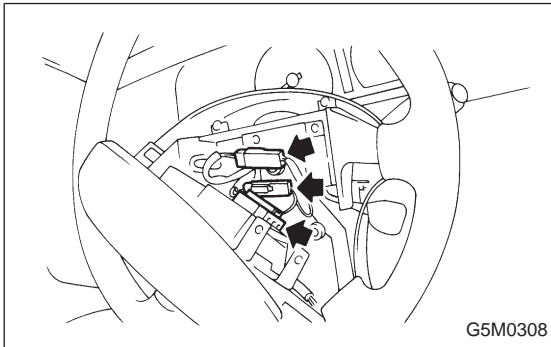

4. ROLL CONNECTOR DOUBLE LOCK INSPECTION AT CONNECTORS (AB2) AND (AB7)

1) Remove airbag module <Ref. to 5-5 [W2A0].>, and check double lock of connectors (AB2) and (AB7) at roll connector.

F: TROUBLE CODE 21**DIAGNOSIS:**

- Airbag control module is faulty.

| |
|--------------------------------|
| Replace airbag control module. |
|--------------------------------|

CAUTION:

Before performing diagnostics on airbag system, turn ignition switch "OFF", disconnect battery ground terminal, and then wait at least 20 seconds.

G: TROUBLE CODE 22**DIAGNOSIS:**

- Airbag main harness circuit is open.
- Airbag module harness (Passenger) circuit is open.
- Airbag control module is faulty.

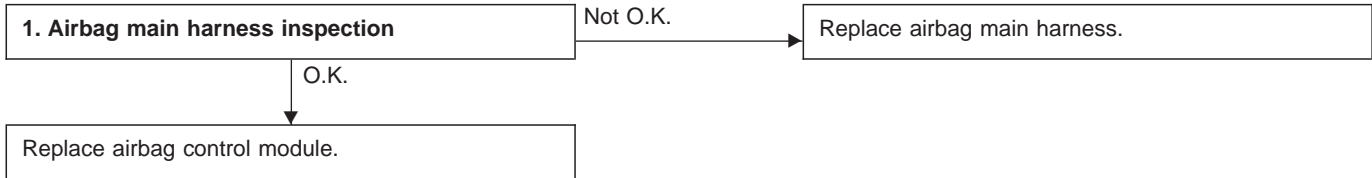
**CAUTION:**

Before performing diagnostics on airbag system, turn ignition switch "OFF", disconnect battery ground cable and then wait at least 20 seconds.

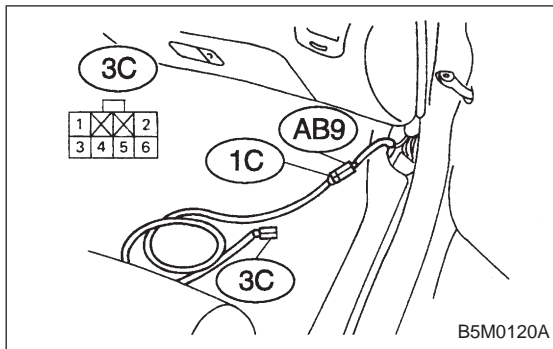
**1. AIRBAG MAIN HARNESS INSPECTION**

1) Remove front pillar lower trim (Passenger side). <Ref. to 5-3 [C700].>, disconnect connector (AB9) and (AB10) and connect connector (AB9) to test harness C connector (1C).

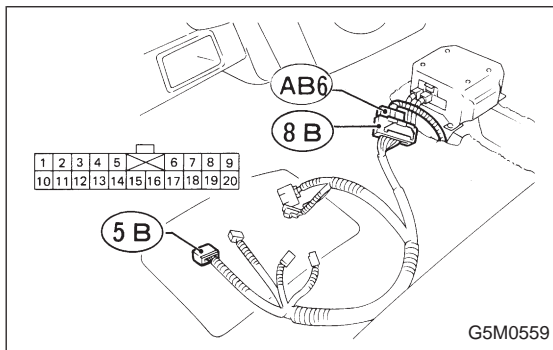

2) Disconnect connector (AB6) <Ref. to 5-5 [W6A0].> from airbag control module, and connect (AB6) to test harness-B connector (8B) terminal.

3) Measure resistance between test harness-B connector (5B) and test harness C connector (3C) terminals.

Connector & terminal / Specified resistance:

(5B) No. 6 — (3C) No. 4 / 10 Ω, or less

(5B) No. 7 — (3C) No. 3 / 10 Ω, or less

H: TROUBLE CODE 34

DIAGNOSIS:

- Airbag main harness circuit (Passenger) is shorted to power supply.
- Airbag module harness (Passenger) is shorted to power supply.
- Airbag control module is faulty.

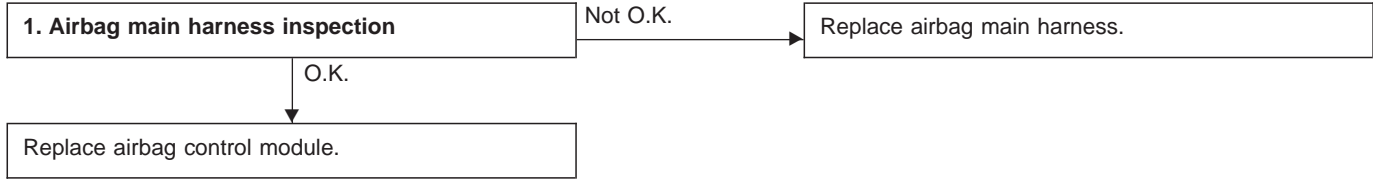

CAUTION:

Before performing diagnostics on airbag system, turn ignition switch “OFF”, disconnect battery ground terminal and then wait at least 20 seconds.

After 20 seconds elapse, remove instrument panel lower cover, and disconnect (AB3) and (AB8), (AB9) and (AB10).

1. AIRBAG MAIN HARNESS INSPECTION

1) Disconnect connector (AB6) from airbag control module <Ref. to 5-5 [W5A0].>, and connect it to test harness-B connector (8B).

2) Connect battery ground cable and turn ignition switch “ON” (engine off).

3) Measure voltage across each test harness-B connector (5B) terminal and body.

(5B) Terminals / Specified voltage:

No. 6 — Body / 1 V, or less

No. 7 — Body / 1 V, or less

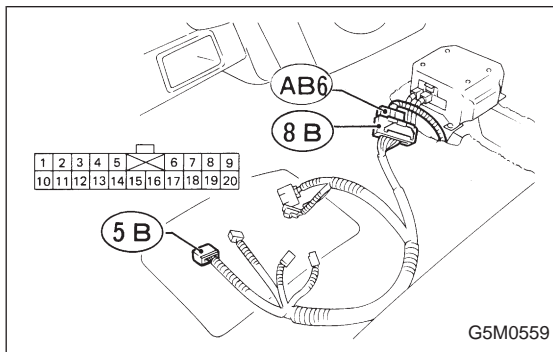

I: TROUBLE CODE 41**DIAGNOSIS:**

- Airbag main harness circuit (Driver) is shorted to ground.
- Airbag module harness circuit (Driver) is shorted to ground.
- Roll connector circuit is shorted to ground.
- Airbag control module is faulty.

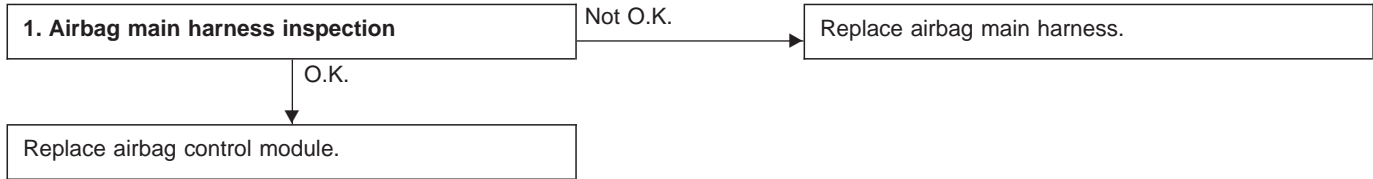
**CAUTION:**

Before performing diagnostics on airbag system, turn ignition switch "OFF", disconnect battery ground cable and then wait at least 20 seconds.

After 20 seconds elapse, remove instrument panel lower cover, and disconnect (AB3) and (AB8), (AB9) and (AB10).

1. AIRBAG MAIN HARNESS INSPECTION

1) Disconnect connector (AB6) from airbag control module <Ref. to 5-5 [W5A0].>, and connect it to test harness-B connector (8B).

2) Measure resistance between test harness-B connector (5B) terminals and body.

(5B) Terminal / Specified resistance:

No. 1 — Body / 200 Ω, or more

No. 14 — Body / 200 Ω, or more

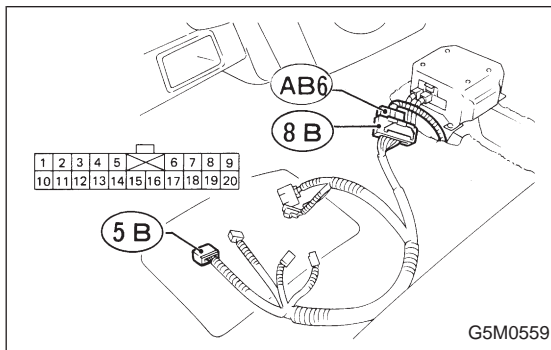

J: TROUBLE CODE 42

DIAGNOSIS:

- Airbag main harness circuit (Passenger) is shorted to ground.
- Airbag module harness circuit (Passenger) is shorted to ground.
- Airbag control module is faulty.

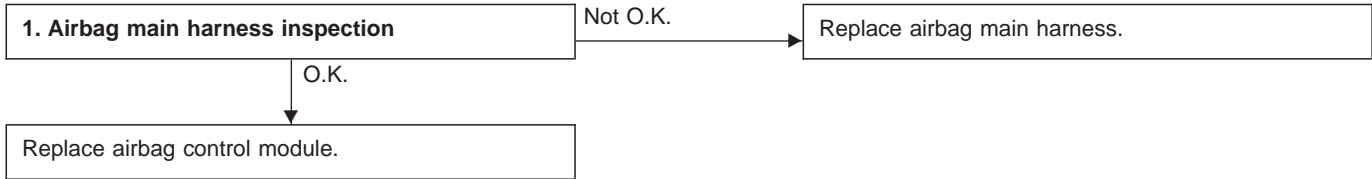

CAUTION:

Before performing diagnostics on airbag system, turn ignition switch “OFF”, disconnect battery ground cable and then wait at least 20 seconds.

After 20 seconds elapse, remove instrument panel lower cover, and disconnect (AB3) and (AB8), (AB9) and (AB10).

1. AIRBAG MAIN HARNESS INSPECTION

1) Disconnect connector (AB6) from airbag control module <Ref. to 5-5 [W5A0].>, and connect it to test harness-B connector (8B).

2) Measure resistance between test harness-B connector (5B) terminals and body.

(5B) Terminal / Specified resistance:

No. 6 — Body / 200 Ω, or more

No. 7 — Body / 200 Ω, or more

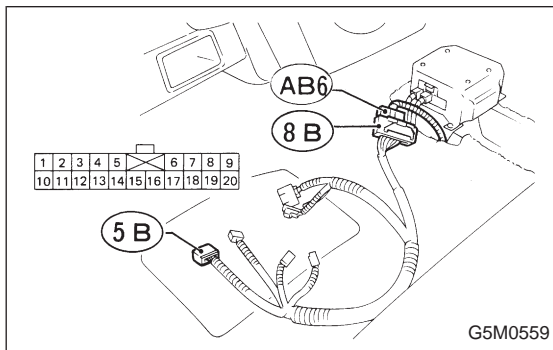

K: TROUBLE CODE 43**DIAGNOSIS:**

- Airbag main harness circuit (Driver) is shorted to power supply.
- Airbag module harness (Driver) is shorted to power supply.
- Roll connector is shorted to power supply.
- Airbag control module is faulty.

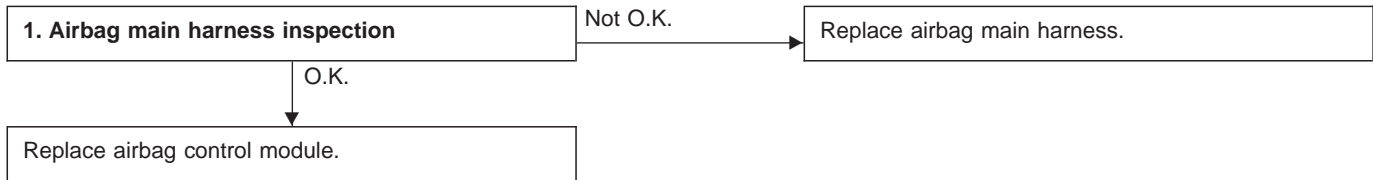
**CAUTION:**

Before performing diagnostics on airbag system, turn ignition switch "OFF", disconnect battery ground terminal and then wait at least 20 seconds.

After 20 seconds elapse, remove instrument panel lower cover, and disconnect (AB3) and (AB8), (AB9) and (AB10).

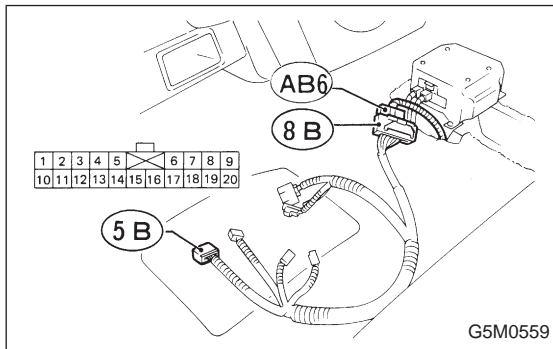
**1. AIRBAG MAIN HARNESS INSPECTION**

1) Disconnect connector (AB6) from airbag control module <Ref. to 5-5 [W5A0].>, and connect it to test harness-B connector (8B).

2) Connect battery ground cable and turn ignition switch "ON" (engine off).

3) Measure voltage across each test harness-B connector (5B) terminal and body.

(5B) Terminals / Specified voltage:

No. 1 — Body / 1 V, or less

No. 14 — Body / 1 V, or less

L: AIRBAG WARNING LIGHT REMAINS ON.

DIAGNOSIS:

- Airbag warning light is faulty.
- Airbag control module-to airbag warning light harness circuit is shorted or open.
- Grounding circuit is faulty.
- Airbag control module is faulty.
- (AB1) and (B39) are not connected properly.

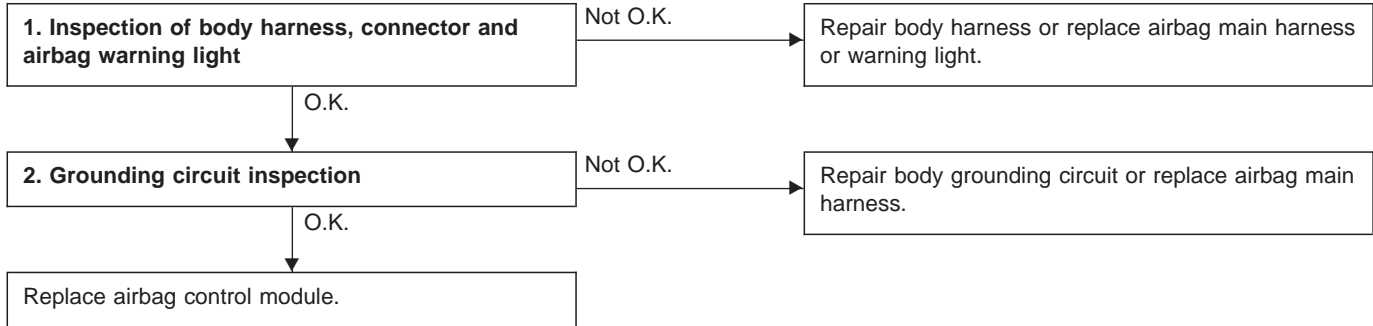

CAUTION:

Before performing diagnostics on airbag system, turn ignition switch "OFF", disconnect battery ground cable and then wait at least 20 seconds.

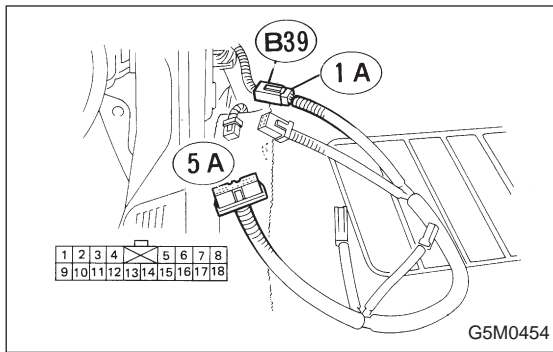

1. INSPECTION OF BODY HARNESS, CONNECTOR AND AIRBAG WARNING LIGHT

1) Turn ignition switch “OFF” and connect connector (B39) to test connector-A connector (1A).

Test harness A-PN98299PA000

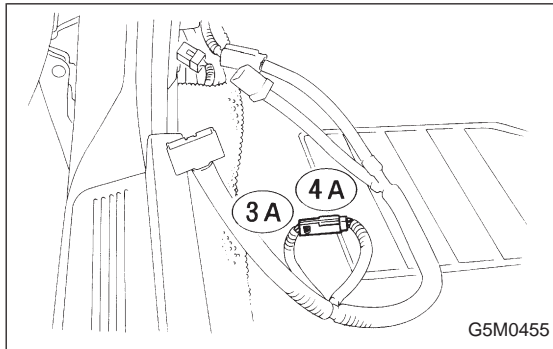

2) Connect battery ground cable and turn ignition switch “ON”, (engine off) and connect connectors (3A) and (4A) to check if warning light goes out. If it does, go to step 4) below. If it remains on, check body harness and repair if necessary.

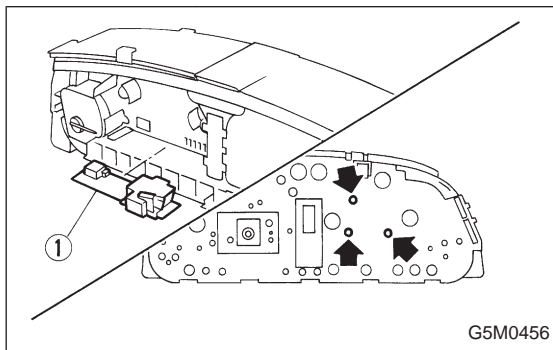

3) If body harness is satisfactory, replace airbag warning light unit ①. After problem has been eliminated, disconnect connectors (3A) and (4A).

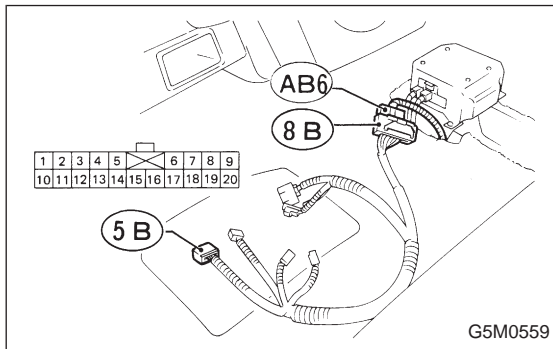

4) Turn ignition switch “OFF”, disconnect battery ground cable and then wait at least 20 seconds, and re-connect connectors (AB1) and (B39).

5) Remove instrument panel lower cover and disconnect (AB3) with (AB8), then disconnect connector (AB6) from airbag control module <Ref. to 5-5 [W5A0].>, and connect it to test harness-B connector (8B).

Test harness B-PN98299PA010

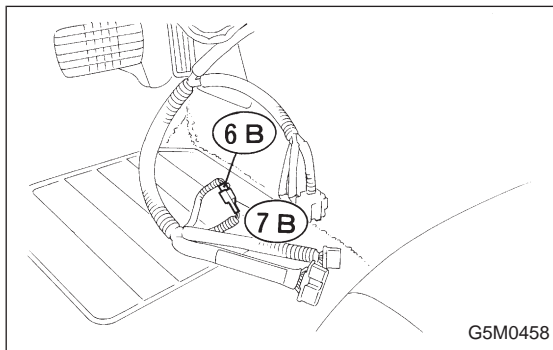

6) Connect battery ground cable and turn ignition switch “ON”, (engine off) and connect connectors (6B) and (7B) to check if warning light goes out. If it does, go to “2. Grounding Circuit Inspection” below. If it remains on, replace airbag main harness. After problem has been eliminated, disconnect connectors (6B) and (7B).

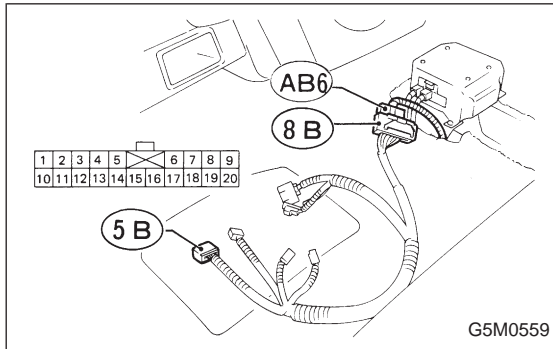
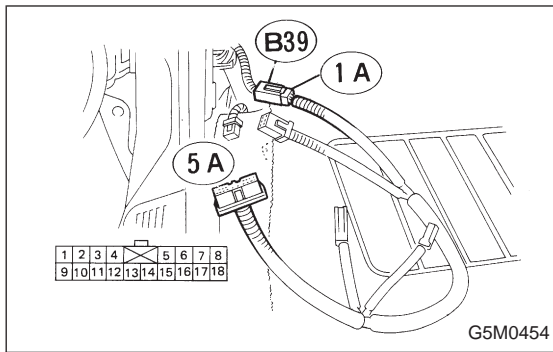

Test harness A-PN98299PA000
Test harness B-PN98299PA010

2. GROUNDING CIRCUIT INSPECTION

1) Turn ignition switch "OFF", disconnect battery ground cable and then wait at least 20 seconds. Disconnect connector (AB1) from bulk harness connector (B39), and connect connector (B39) to test harness-A connector (1A). Measure resistance between connector (5A) terminal and body.

(5A) Terminal / Specified resistance:
No. 17 — Body / 10 Ω, or less
No. 18 — Body / 10 Ω, or less

If resistance is greater than 10 ohms, body grounding circuit is faulty and should be repaired. If resistance is less than 10 ohms, go to step 2) below.

2) Connect connectors (AB1) and (B39). Disconnect connector (AB6) from airbag control module <Ref. to 5-5 [W5A0].>, and connect it to test harness-B connector (8B). 3) Measure resistance between each test harness-B connector (5B) terminal and body.

(5B) Terminal / Specified resistance:
No. 11 — Body / 10 Ω, or less
No. 12 — Body / 10 Ω, or less

If resistance is greater than 10 ohms, replace airbag main harness.

If resistance is less than 10 ohms, replace airbag control module.

M: AIRBAG WARNING LIGHT REMAINS OFF.**DIAGNOSIS:**

- Fuse No. 15 is blown.
- Body harness circuit is open.
- Airbag warning light is faulty.
- Airbag main harness is faulty.
- Airbag control module is faulty.

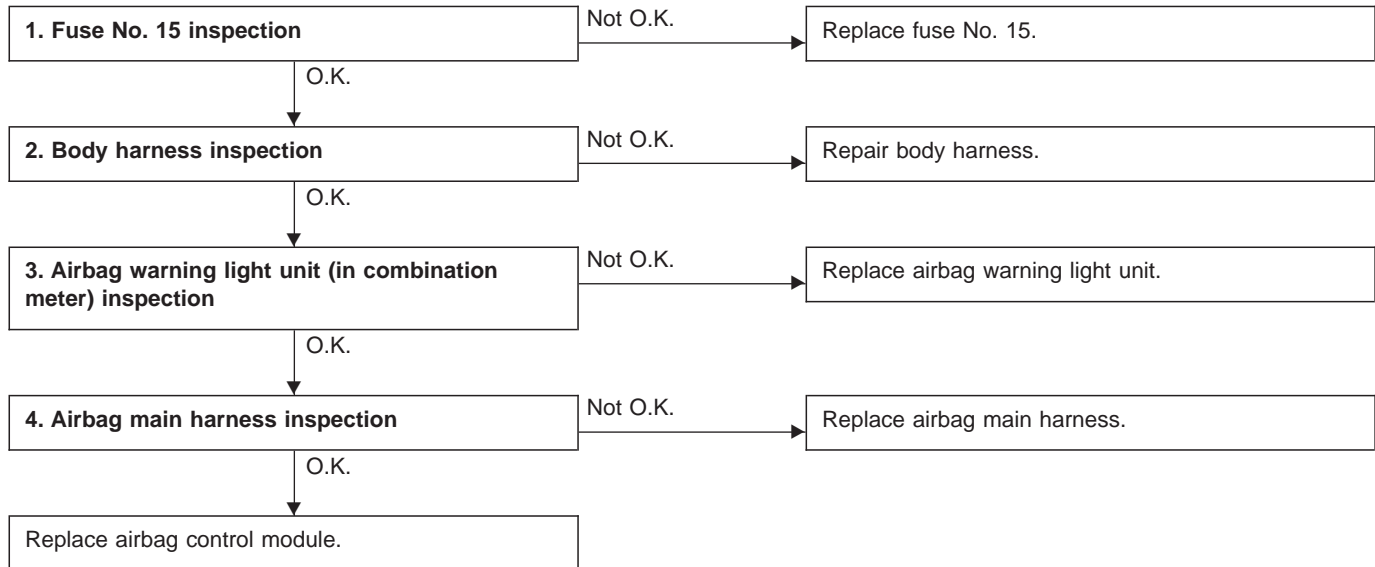
**CAUTION:**

Before performing diagnostics on airbag system, turn ignition switch “OFF”, disconnect battery ground terminal, and then wait at least 20 seconds.

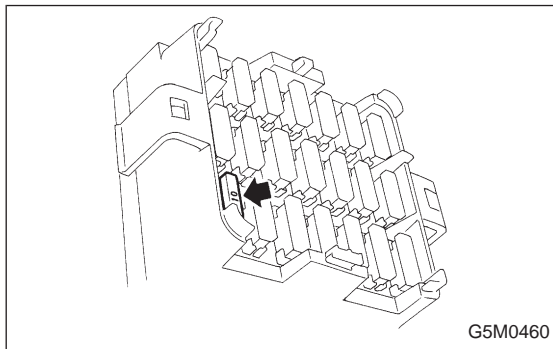
**1. FUSE No. 15 INSPECTION**

- 1) Remove and visually check fuse No. 15.
- 2) If fuse is blown, replace it with a new one. After connecting battery cable and turning ignition switch “ON”, if it blows again, proceed to “2. BODY HARNESS INSPECTION”.

2. BODY HARNESS INSPECTION

- 1) Turn ignition switch “ON” (engine off) to make sure other warning lights (in combination meter) illuminate. If they do not, check body harness.

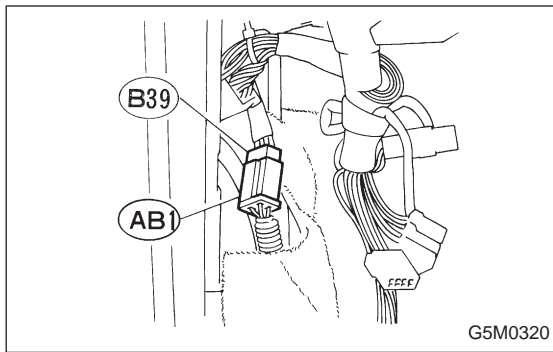

3. AIRBAG WARNING LIGHT UNIT (IN COMBINATION METER) INSPECTION

- 1) Turn ignition switch "OFF", disconnect battery ground cable and then wait at least 20 seconds.
- 2) Disconnect bulk harness connector (B39) from connector (AB1).

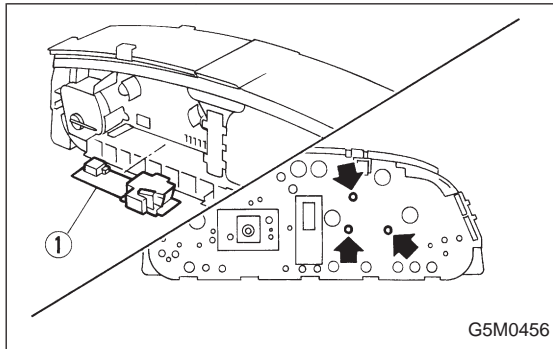

- 3) Connect battery ground cable and turn ignition switch "ON" (engine off) to make sure airbag warning light illuminates.
- If it does not, replace airbag warning light unit ①.

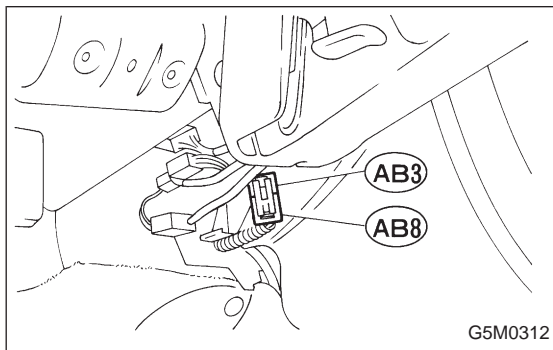

4. AIRBAG MAIN HARNESS INSPECTION

- 1) Turn ignition switch "OFF", disconnect battery ground cable and then wait at least 20 seconds.
- 2) Connect bulk harness connector (B39) and connector (AB1).
- 3) Disconnect connectors (AB3) and (AB8) below steering column. <Ref. to 5-5 [M2-6].>

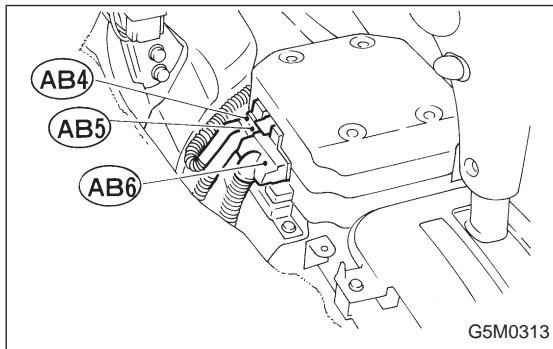

- 4) Disconnect connector (AB6) from airbag control module. <Ref. to 5-5 [W5A0].>
- 5) Connect battery ground cable and turn ignition switch "ON" to make sure airbag warning light illuminates.

N: WARNING LIGHT INDICATES TROUBLE CODE, THEN NORMALITY CODE.
— FLASHING TROUBLE CODE —

DIAGNOSIS:

- Airbag system component parts are faulty.

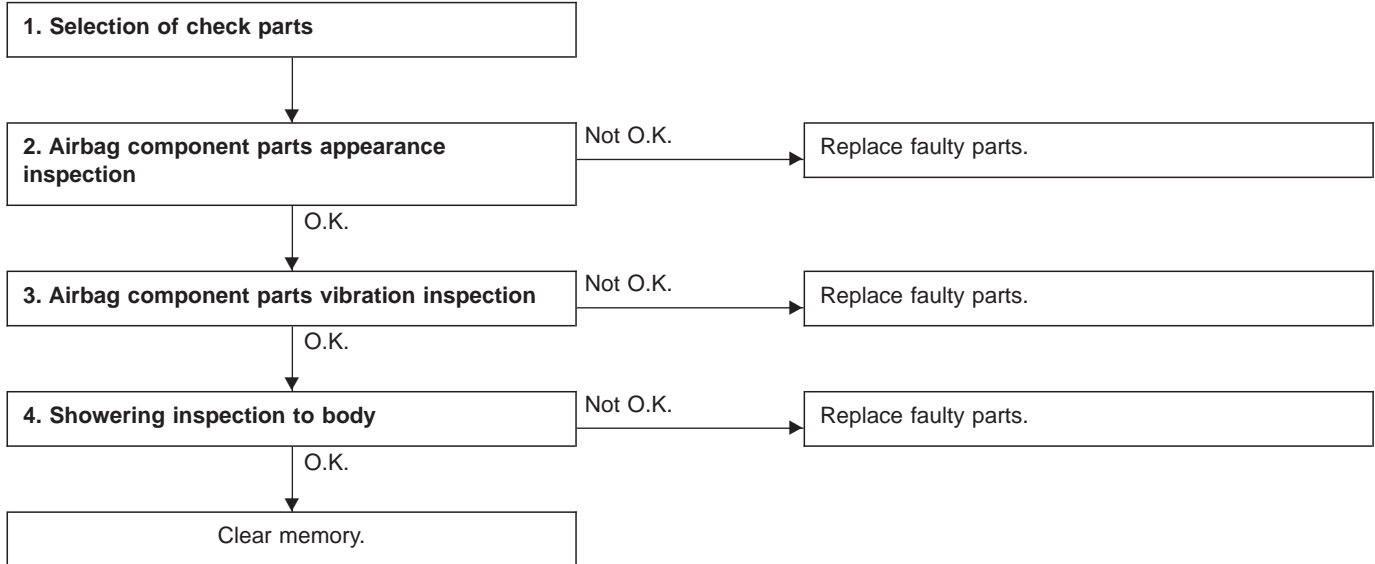

CAUTION:

Before performing diagnostics on airbag system, turn ignition switch “OFF”, disconnect battery ground cable, and then wait at least 20 seconds.

1. SELECTION OF CHECK PARTS

1) Conduct on-board diagnostic and call up trouble codes stored in memory. <Ref. to 5-5 [T1B0].>

2) Select trouble code required to check airbag component parts from those listed in table and reproduce symptom.

| Trouble codes | Check parts | Refer to 5-5: |
|---------------|--|------------------------------|
| 04 | <ul style="list-style-type: none"> ● Airbag module (Passenger) ● Airbag main harness ● Airbag control module | W2A2 W4A0 W5A0 |
| 11 | <ul style="list-style-type: none"> ● Fuse No. 8 ● Airbag main harness ● Airbag control module ● Body harness | T5A3 W4A0 W5A0 — |
| 12 | <ul style="list-style-type: none"> ● Roll connector ● Airbag module (Driver) ● Airbag main harness ● Airbag control module | W6A0 W2A1 W4A0 W5A0 |
| 13 | <ul style="list-style-type: none"> ● Airbag module (Driver) ● Roll connector ● Airbag main harness ● Airbag control module | W2A1 W6A0 W4A0 W5A0 |
| 21 | <ul style="list-style-type: none"> ● Airbag control module | W5A0 |
| 22 | <ul style="list-style-type: none"> ● Airbag module (Passenger) ● Airbag main harness ● Airbag control module | W2A2 W4A0 W5A0 |
| 34 | <ul style="list-style-type: none"> ● Airbag main harness ● Airbag module (Passenger) ● Airbag control module | W4A0 W2A2 W5A0 |
| 41 | <ul style="list-style-type: none"> ● Airbag module (Driver) ● Roll connector ● Airbag main harness ● Airbag control module | W2A1 W6A0 W4A0 W5A0 |
| 42 | <ul style="list-style-type: none"> ● Airbag module (Passenger) ● Airbag main harness ● Airbag control module | W2A2 W4A0 W5A0 |
| 43 | <ul style="list-style-type: none"> ● Airbag module (Driver) ● Roll connector ● Airbag main harness ● Airbag control module | W2A1 W6A0 W4A0 W5A0 |

2. AIRBAG COMPONENT PARTS APPEARANCE INSPECTION

1) Conduct appearance inspection on parts selected.

NOTE:

Also check connector terminals, wiring harness, case, etc. for damage.

3. AIRBAG COMPONENT PARTS VIBRATION INSPECTION

1) Gently shake check parts (to determine faults.)

- 2) To check airbag module or roll connector, turn and tilt steering wheel.



4. SHOWERING INSPECTION TO BODY

- 1) Spray water on vehicle body.

CAUTION:

Do not directly spray water on airbag components.

- 2) Check passenger compartment for traces of leaking.

NOTE:

Also check wiring harnesses as water may leak along them and get airbag component parts wet.

O: WARNING LIGHT INDICATES TROUBLE CODE, THEN NORMALITY CODE.

— FLASHING NORMALITY CODE —

DIAGNOSIS:

- Airbag connector is faulty.
- Fuse No. 16 is blown.
- Airbag main harness is faulty.
- Airbag control module is faulty.
- Body harness is faulty.

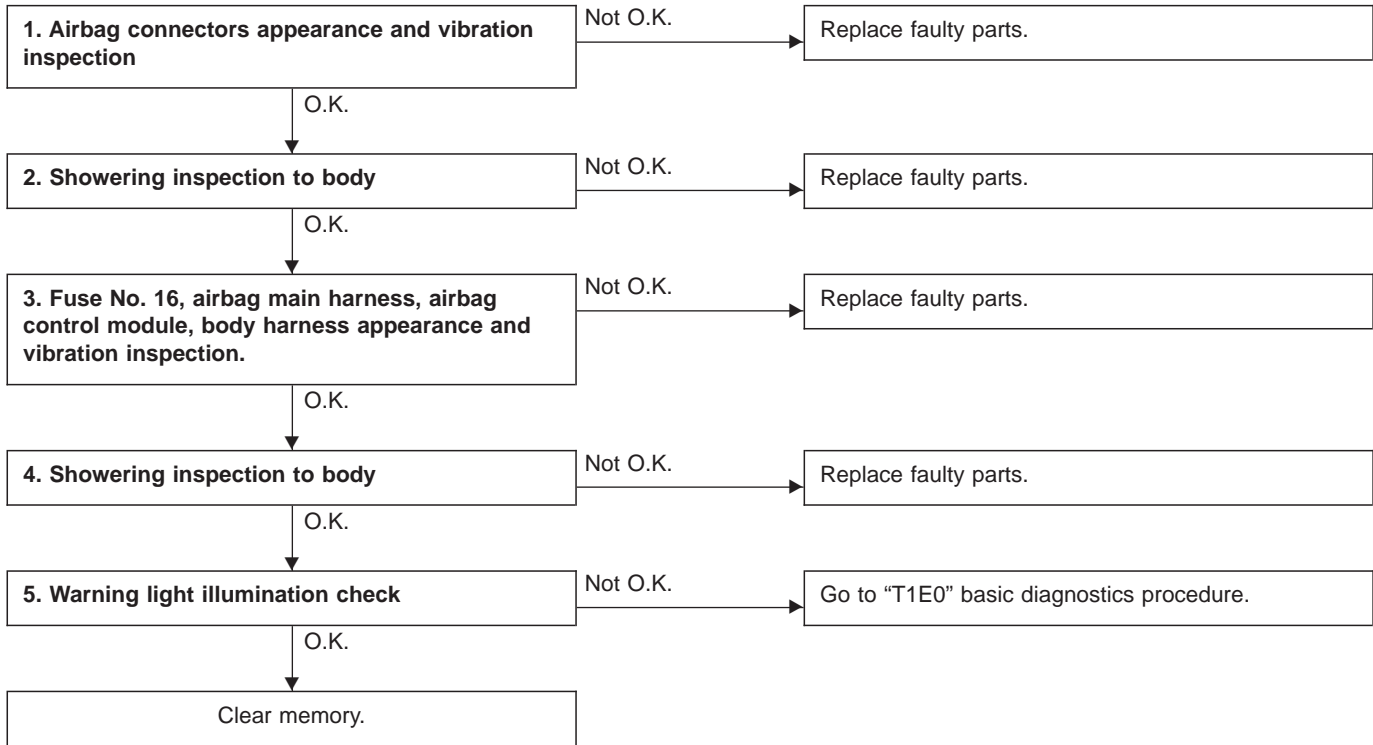

CAUTION:

Before performing diagnostics on airbag system, turn ignition switch "OFF", disconnect battery ground cable, and then wait at least 20 seconds.

1. AIRBAG CONNECTORS APPEARANCE AND VIBRATION INSPECTION

1) Conduct appearance inspection on airbag connectors (AB2 through AB8). <Ref. to 5-5 [T300].>

NOTE:

Check terminals, case and wiring harnesses for damage.

2) Conduct vibration inspection on airbag connectors (AB2 through AB8). <Ref. to 5-5 [T300].>

NOTE:

Gently shake each airbag connector.



2. SHOWERING INSPECTION TO BODY

- 1) Spray water on vehicle body.

CAUTION:

Do not directly spray water on airbag connectors.

- 2) Check passenger compartment for traces of leaking.

NOTE:

If leaks are noted, also check wiring harnesses as water may leak along them and wet airbag connectors.

3. FUSE NO. 16, AIRBAG MAIN HARNESS, AIRBAG CONTROL MODULE, BODY HARNESS APPEARANCE AND VIBRATION INSPECTION

- 1) Conduct appearance inspection on fuse No. 16, airbag main harness <Ref. to 5-5 [W3A0].>, airbag control module <Ref. to 5-5 [W4A0].> and body harness.

NOTE:

Also check connectors, terminals, wiring harnesses and case for damage.

- 2) Conduct vibration inspection on fuse No. 16, airbag main harness, airbag control module and body harness.

NOTE:

Gently shake each part.



4. SHOWERING INSPECTION TO BODY

- 1) Spray water on vehicle body.

CAUTION:

Do not directly spray water on each part.

- 2) Check passenger compartment for traces of leaking.

NOTE:

If leaks are noted, check wiring harnesses as water may leak along them and get parts wet.

5. WARNING LIGHT ILLUMINATION CHECK

- 1) Turn ignition switch "ON" (engine "OFF") and observe airbag warning light.

Airbag warning light comes "ON" for 8 seconds then goes out and stays out.