

2. Differential Case

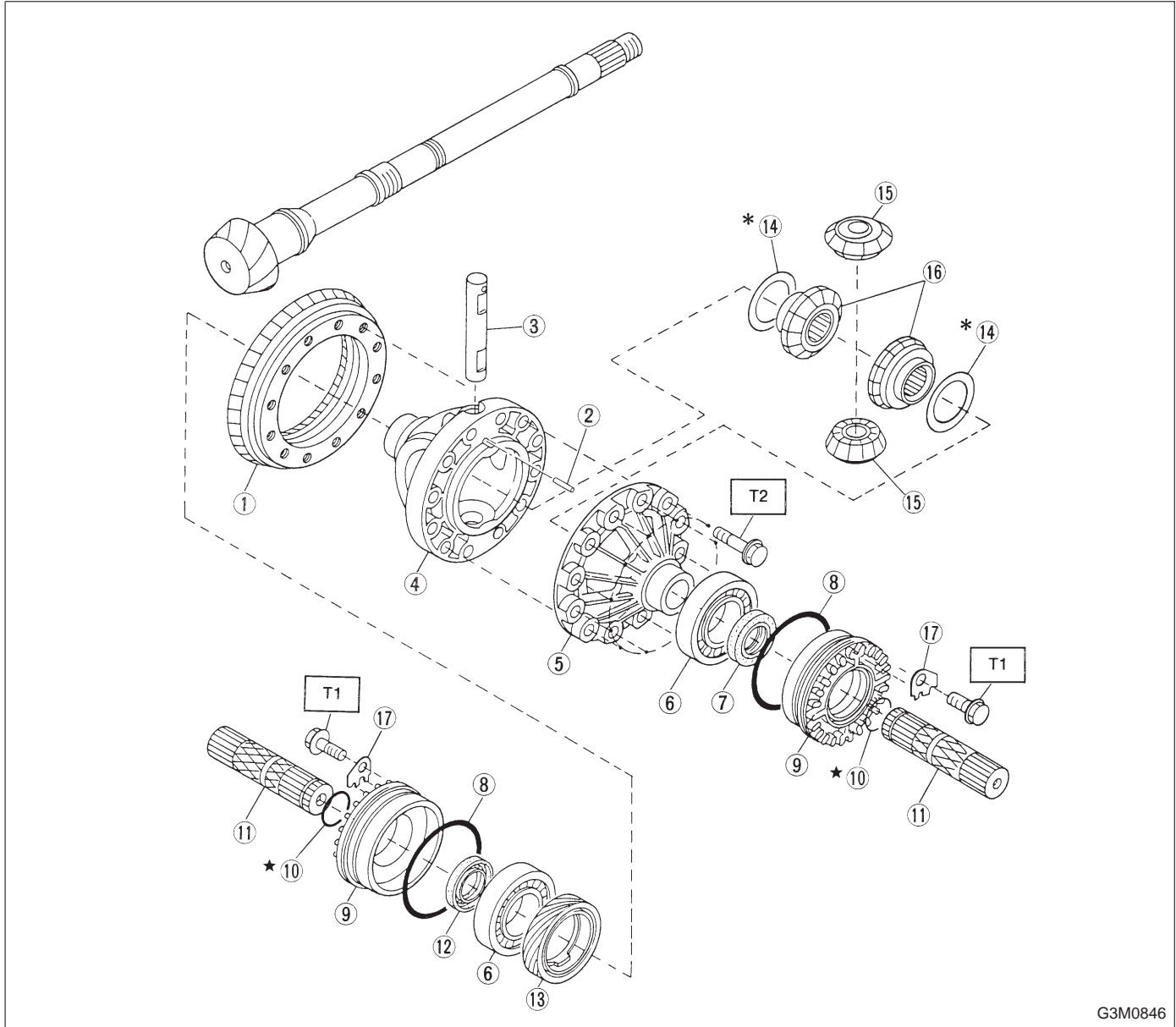

G3M0846

- ① Crown gear
- ② Straight pin
- ③ Pinion shaft
- ④ Differential case (RH)
- ⑤ Differential case (LH)
- ⑥ Taper roller bearing
- ⑦ Oil seal (LH)
- ⑧ O-ring
- ⑨ Differential side retainer
- ⑩ Circlip
- ⑪ Axle shaft
- ⑫ Oil seal (RH)
- ⑬ Speedometer drive gear
- ⑭ Washer
- ⑮ Differential bevel pinion
- ⑯ Differential bevel gear
- ⑰ Lock plate

Tightening torque: N·m (kg·m, ft·lb)

T1: 25±2 (2.5±0.2, 18.1±1.4)

T2: 62±3 (6.3±0.3, 45.6±2.2)