

2. Rear Case (FWD Model)

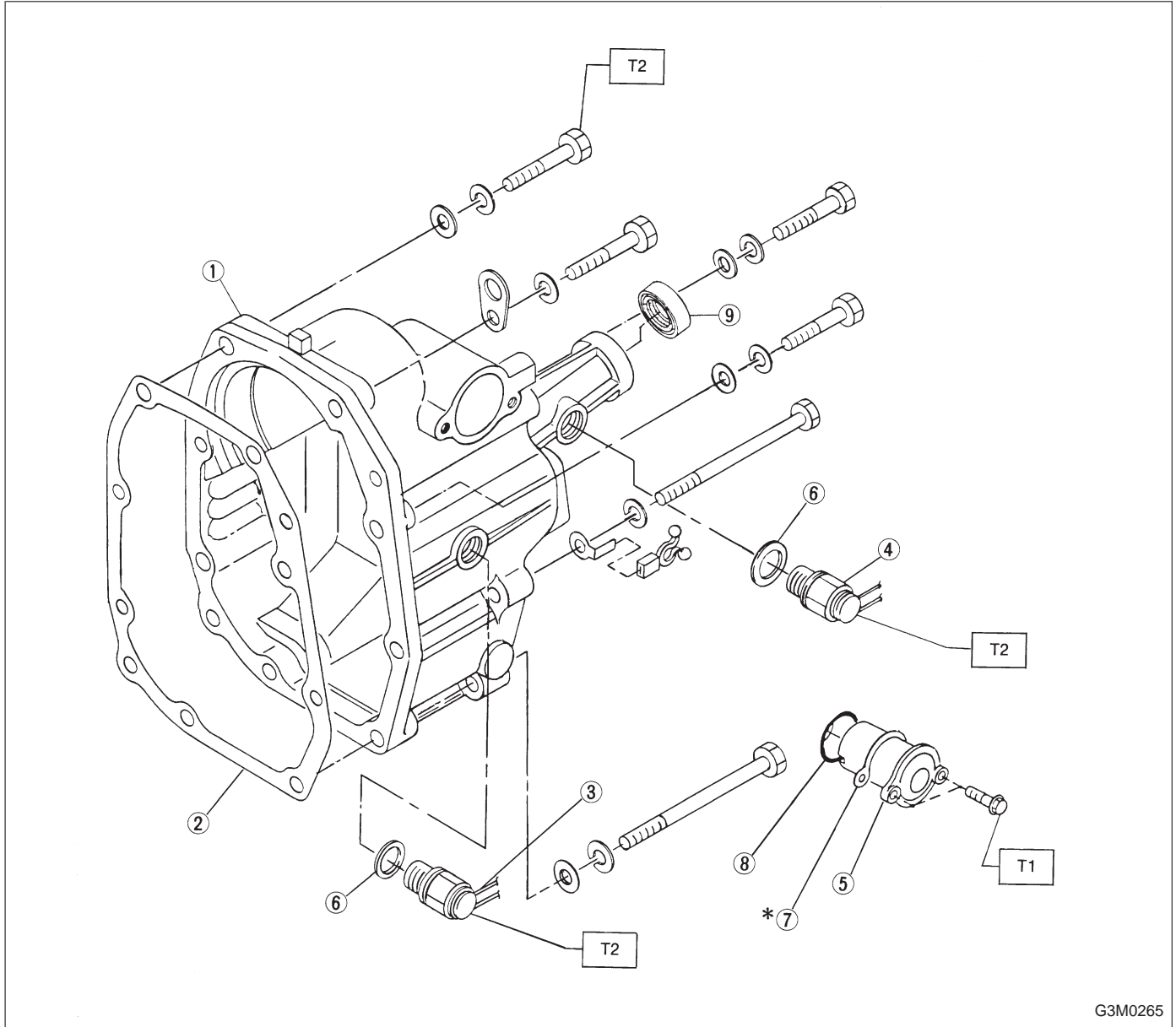

- ① Rear case
- ② Case gasket
- ③ Back-up light switch
- ④ Neutral switch
- ⑤ Reverse check sleeve ASSY
- ⑥ Gasket
- ⑦ Adjusting shim

- ⑧ O-ring
- ⑨ Oil seal

Tightening torque: N·m (kg·m, ft·lb)
T1: 6.4±0.5 (0.65±0.05, 4.7±0.4)
T2: 25±5 (2.5±0.5, 18.1±3.6)