

B: INSTALLATION**CAUTION:**

Replace gaskets with new ones.

- 1) Install rear exhaust pipe bracket to rubber cushion.

NOTE:

To facilitate installation, apply a coat of SUBARU CRC to mating area of rubber cushion in advance.

SUBARU CRC (Part No. 004301003)

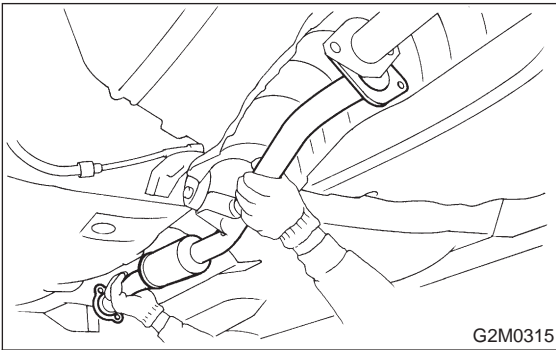

- 2) Install rear exhaust pipe to muffler.

Tightening torque:

48 ± 5 N·m (4.9 ± 0.5 kg·m, 35.4 ± 3.6 ft·lb)

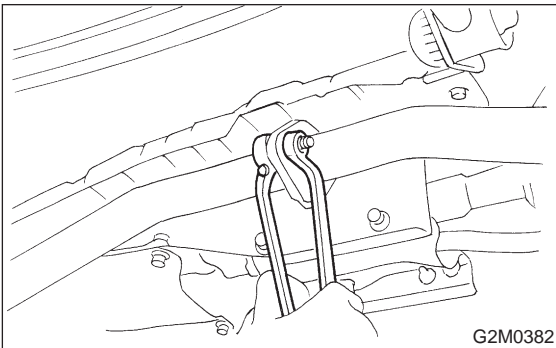

- 3) Install rear exhaust pipe to front catalytic converter.

Tightening torque:

18 ± 5 N·m (1.8 ± 0.5 kg·m, 13.0 ± 3.6 ft·lb)

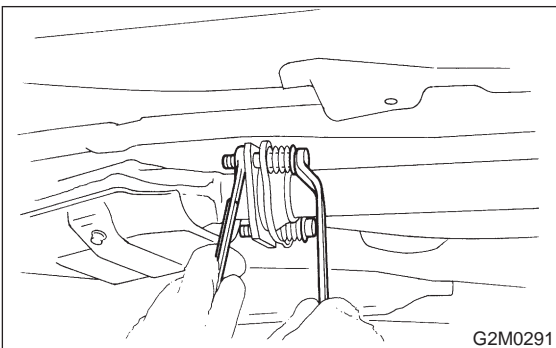
**3. Muffler****A: REMOVAL AND INSTALLATION**

- 1) Separate muffler from rear exhaust pipe.

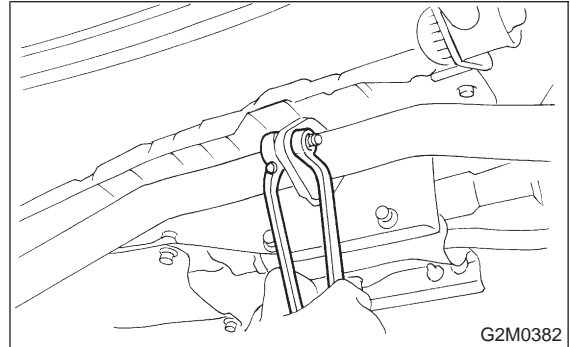

- 2) Remove left and right rubber cushions.

CAUTION:

Be careful not to pull down front exhaust pipe and front catalytic converter.

NOTE:

To facilitate removal, apply a coat of SUBARU CRC to mating area of rubber cushions in advance.

SUBARU CRC (Part No. 004301003)

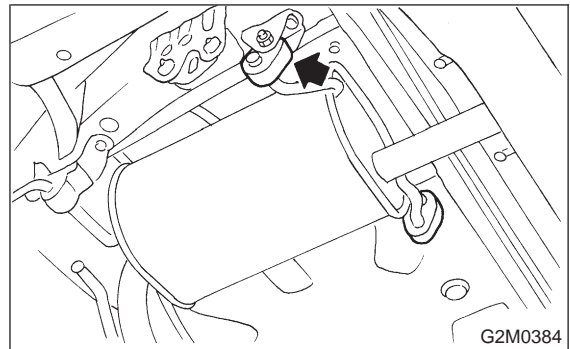

- 3) Remove front rubber cushion, and detach muffler assembly.

NOTE:

To facilitate removal, apply a coat of SUBARU CRC to mating area of rubber cushion in advance.

SUBARU CRC (Part No. 004301003)

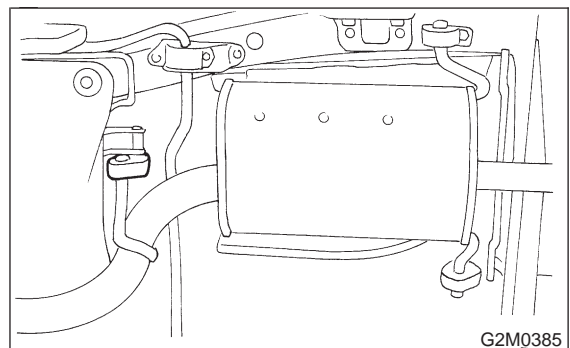

4) Installation is in the reverse order of removal.

CAUTION:

Replace gasket with a new one.

Tightening torque:

$48 \pm 5 \text{ N}\cdot\text{m}$ ($4.9 \pm 0.5 \text{ kg}\cdot\text{m}$, $35.4 \pm 3.6 \text{ ft}\cdot\text{lb}$)

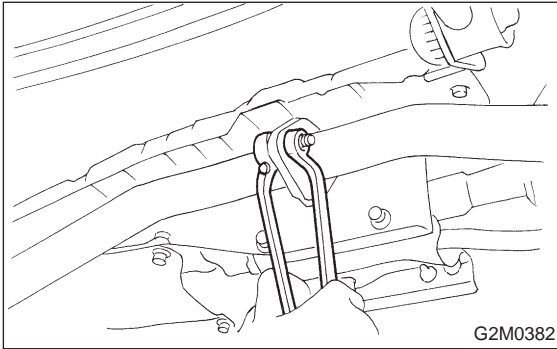

MEMO: