



Technicians Reference Booklet

**Brake Systems
Series Module**

Module 501

MSA5P0170C

Technical Training

**© Copyright 2002
Subaru of America, Inc.**

All rights reserved. This book may not be reproduced in whole or in part without the express permission of Subaru of America, Inc.

Subaru of America, Inc. reserves the right at any time to make changes or modifications to systems, procedures, descriptions, and illustrations contained in this book without necessarily updating this document. Information contained herein is considered current as of March 2002.

Brake Systems

Brake Systems

Table of Contents

Introduction	8
General Overview	8
General ABS Operation	19
Teves Mark IV with ABS/TCS	24
Vehicle Dynamic Control (VDC)	42
Sensors	45
Service Bulletins	53
501 Module Service Tech TIPS	54

Slide Sequence

Slide No.	Description	Page No.
1	Title Slide (Brakes System)	
2	Created By	
3	Teaching Aids	
4	Introduction	
5	Title Slide (General Overview)	
6	Dual Diagonal Brake System (artwork)	8
7	Front Disc Brake	9
8	Rear Disc Brake	9
9	Front Disc Brake	9
10	Depressing Caliper Piston (older)	10
11	Hill Holder™ System	10
12	Pressure Hold Valve	10
13	Clutch Pedal Free Play	11
14	Clutch Lever Free Play	11
15	Adjusting the PHV	11
16	Master Cylinder Cross Section	12
17	Master Cylinder	12
18	Reed Switch Schematic (artwork)	12
19	Reed Switch Construction	12
20	Typical Proportioning Valve	13
21	2001 Legacy Rear Drum Brake and VDC Model (artwork)	13
22	2001 Legacy Rear Disc Brake Model (artwork)	13
23	Brake Booster	14
24	Booster Check (artwork)	14
25	Measuring Rotor Thickness (artwork)	15
26	Measuring Rotor Run out	15
27	Rotor Resurfacing	15
28	Piston Removal	16
29	Removing Pistons	16
30	Front Caliper Lubrication Points	17
31	Pads Assembled	17
32	Locating Brake Vibration Source (artwork)	17
33	Self-Adjuster Operation (Brakes Applied)	17
34	Drum Brake Lubrication Points	18
35	Legacy Parking Brake System	18
36	Title Slide (General ABS Operation)	19
37	Hydraulic Control Unit	19
38	Valve Relay Circuit	20
39	Motor Relay Circuit	21
40	Speed Sensor Operation (artwork)	22
41	Speed Sensor Components	22
42	Title Slide (Teves Mark IV with ABS/TCS)	24
43	Master Cylinder - Traction Control	24
44	Teves Mark IV Hydraulic Control Unit	25
45	Brake Pedal Stroke Sensor	25
46	Wheel Speed Sensor / Tone Wheel	25
47	Combination Meter	25
48	TCS Off Switch	26
49	ABS/TCS Control Module	26
50	Normal Braking (artwork)	27
51	ABS Braking Pressure Drop (artwork)	28

Slide Sequence

Slide No.	Description	Page No.
52	ABS Braking Pressure Hold (artwork)	29
53	ABS Pressure Rise (artwork)	30
54	TCS Logic-Engine Control (artwork)	31
55	TCS Logic- Engine Control & Brake Control (artwork)	31
56	TCS Logic / Wheel Slip Recognition (artwork)	32
57	TCS Logic - One Wheel Slip (artwork)	32
58	TCS Logic - Two Wheel Slip (artwork)	32
59	TCS Logic - One Wheel Slip (artwork)	33
60	TCS Logic - Two Wheel Slip (artwork)	33
61	TCS Pressure Rise (artwork)	34
62	TCS Pressure Hold (artwork)	35
63	TCS Pressure Drop (artwork)	36
64	TCS Logic / Valve Control (artwork)	37
65	Title Slide (Vehicle Dynamic Control (VDC))	42
66	VDC Logic Chart	42
67	Understeer	42
68	Oversteer	42
69	Cornering Force	42
70	Oversteer While Accelerating	43
71	Understeer While Accelerating	43
72	Oversteer While Braking	44
73	Understeer While Braking	44
74	Title Slide (Sensors)	45
75	Steering Position Sensor	45
76	Steering Position Sensor Construction	45
77	Steering Position Sensor Waveform	45
78	Degrees of Turn	45
79	Wheel Speed Sensor	46
80	Yaw Sensor	46
81	Yaw Sensor (artwork)	46
82	Hydraulic Control Unit	46
83	VDC CM Connector	47
84	VDC CM Location	47
85	Pressure Reducing Mode (artwork)	47
86	Pressure Holding Mode (artwork)	48
87	Pressure Increasing Mode (artwork)	48
88	Pressure Increasing Mode (artwork)	48
89	Pressure Holding Mode (artwork)	49
90	Pressure Reducing Mode (artwork)	49
91	Copyright	
92	The End	

Brake Systems

Introduction

This Technicians Reference Booklet introduces the brake systems used on Subaru vehicles. It covers the component operation, troubleshooting, diagnosis, and service precautions and procedures. This information is presented with special emphasis on procedures, tools and materials unique to the Legacy, Forester and Impreza vehicles. Subaru-specific servicing procedures and precautions are also included in this booklet.

The text and illustrations are derived from and follow the classroom lectures and slide presentations. They are intended to supplement and reinforce classroom instruction and to serve as a home-study reference source. Lists of applicable Service Bulletins, important notes and cautions, and Special Tools are included within this booklet. Pages for noting additional Diagnostic Tips and Notes are also provided.

Technicians Worksheets are to be completed during the hands-on lab work segments of the Brake System Module.

Always refer to the appropriate model year Subaru Service Manual and the Applicable service bulletins for all specifications and detailed service procedures.

General Overview

SUBARU Brake Systems Overview

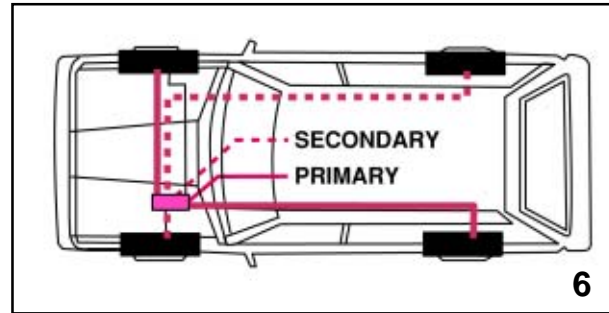

Dual diagonal brake system

All Subaru vehicles are equipped with a dual diagonal brake system. A master cylinder feeds a crisscross hydraulic circuit consisting of a primary circuit and a secondary circuit. Braking force is transmitted to the right-front and the left-rear brakes by the primary system. Braking force is delivered to the left-front and the right-rear brakes by the secondary system. This safety feature not only provides even braking, but also provides balanced braking in the event of failure of one of the circuits.

Brake Systems

Disk Brake Overview

All disc brakes are self-adjusting and feature a single or dual piston in a free floating caliper design. The type of caliper used depends on model type and trim level.



Front Disk Brake

Front disc brakes feature a ventilated disc which has high heat dissipation and superb braking stability. Due to the nature of their design, disc brakes quickly restore the original braking performance when wet.



Rear Disc Brake

Rear disc brakes features are similar in a solid rotor design brake mechanism.

All current Subaru vehicles equipped with a rear drum brake system will be of the self adjusting type.



Front Disk Brakes

Disk brakes on Subaru vehicles feature self-adjusting, single piston or dual piston, free-floating calipers that slide on pins. The calipers are designed to provide easy access to the pads. The pads are equipped with wear indicators that begin to squeal when the pad wears to a specific minimum pad thickness. Ventilated front rotors keep the brakes cooler. Solid rotors are used with rear brakes.

When the brake pedal is depressed and hydraulic pressure is supplied to the caliper, the piston slides through a flexible square-cut seal to push against the inside pad, and the caliper body is pulled against the outer pad. As the pad wears, the piston slides farther through the seal to take up the slack.

When the brake pedal is released, the piston is pulled away from the pad by the force of the seal returning to its normal square shape.

Brake Systems

Pad Replacement Procedures

When replacing disc brake pads, follow the steps listed below. Always replace the pads in sets of four. Remember that the brakes are free-floating; guide pins and the sliding surfaces of the pad and clips must be properly lubricated, and sufficient clearance must exist between the top pad and the holder.

- 1) Remove the lock pins and raise the caliper
- 2) Remove the pads
- 3) Loosen the bleeder screw and push the piston in the cylinder
- 4) Install new pads
- 5) Reinstall the caliper and the brake cable

NOTE: IF THE PAD FITS TIGHTLY IN THE PAD HOLDER, RAPID PAD WEAR CAN OCCUR.



Depressing caliper piston (older)

Because the new pads will be thicker than the old ones being replaced, the caliper piston needs to be retracted in the caliper body. Before pushing the piston back into the caliper, loosen the bleeder screw. After the pads are replaced and the brake calipers are reassembled, depress the brake pedal several times to take up the slack between the caliper piston and the brake pad before test-driving the vehicle.

Hill Holder (TM) system

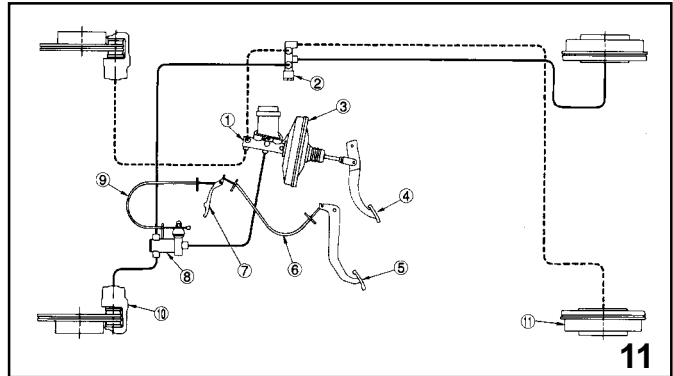

Hill-Holder™ system

Subaru brake systems also incorporate a unique Hill-Holder (TM) system. It is standard equipment on all 1990 to 1994 Legacy vehicles with manual transmissions. The system prevents rollback when the vehicle is starting on an uphill grade. The heart of the Hill-Holder (TM) system is the pressure hold valve (PHV). Connected in series with the primary circuit, it works in conjunction with the clutch pedal via a linking device to hold pressure in the primary hydraulic brake circuit.

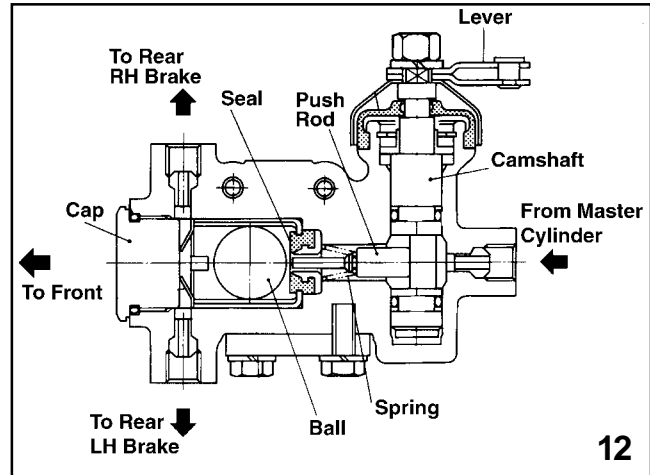

Pressure hold valve

Brake Systems

When the vehicle comes to a stop on an uphill grade greater than or equal to 3 degrees, a push rod inside the PHV retracts when the clutch is depressed. This permits a ball in the PHV to roll backwards to seal hydraulic pressure in the primary circuit. When the brake pedal is released, the pressure trapped in the primary circuit by the ball holds the vehicle stationary. When the clutch pedal is released, the push rod extends once more to unseat the ball and release the hydraulic pressure.

NOTE: THE PHV IS NON-SERVICEABLE AND MUST BE REPLACED AS A UNIT.

Hydraulic Servicing Precautions

When servicing any of the hydraulic components, follow these precautions carefully.

- 1) Use DOT 3 or DOT 4 brake fluid.
- 2) Clean internal brake components with alcohol. External brake components may be cleaned with brake clean type solvents.
- 3) Use specified lubricants.
- 4) Do not hone aluminum cylinders.
- 5) Do not use silicone type brake fluids

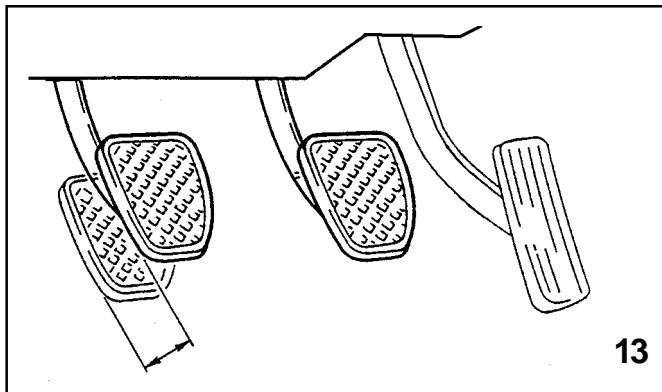

Clutch pedal free play

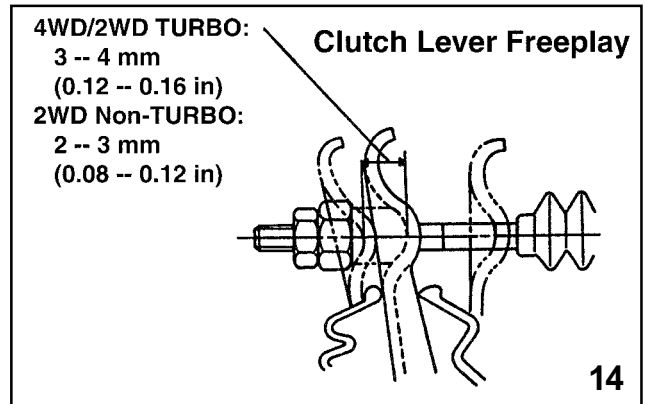

Clutch lever free play

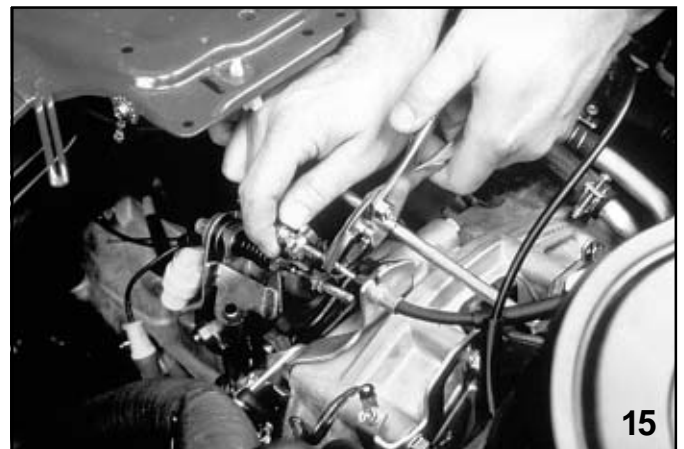

Adjusting the PHV

On 1990 to 1994 Legacy vehicles with manual transmission, check the operation of the Hill-Holder (TM) system at every maintenance interval by road-testing the vehicle. If the system does not function properly, first verify the clutch pedal free play. Check it at either the pedal or the lever and adjust as necessary. If the vehicle will not hold on an incline of 3 degrees or greater, tighten the adjusting nut of the pressure hold valve cable until proper operation is achieved. If the brakes release late, loosen the adjusting nut on the PHV.

NOTE: CONFIRM PROPER OPERATION BY ROAD-TESTING THE VEHICLE.

The PHV can also be adjusted to operate on very small inclines. Install a shim (P/N: 725807000) between the frame and the support to raise the front of the PHV.

NOTE: ONLY ONE SHIM IS ALLOWED.

Brake Systems

Master Cylinder

A sealed reservoir tank has been adopted to extend the service life of the brake fluid

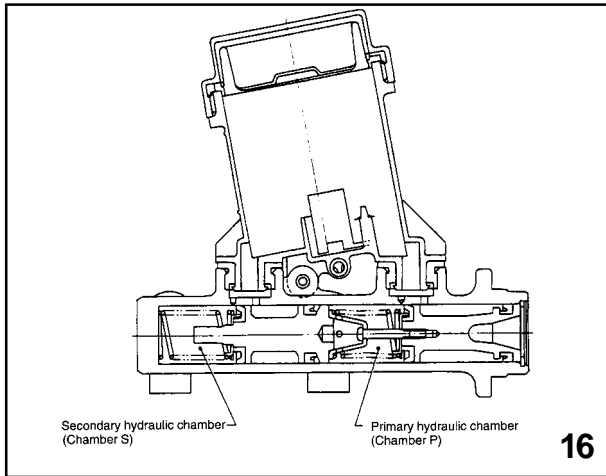

Master cylinder cross-section

The master cylinder used in all current Subaru vehicles is divided into two chambers: Primary hydraulic chamber (Chamber P) and Secondary hydraulic Chamber (Chamber S).



Master Cylinder

The primary chamber supplies working pressure to the right-front and left-rear hydraulic circuits while the secondary chamber supplies working pressure to the left-front and right-rear hydraulic circuit. In the event of a hydraulic circuit failure, the vehicle will still maintain some braking performance.

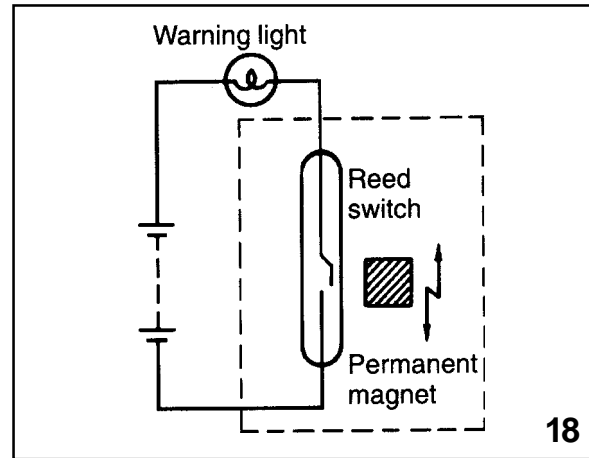

Reed Switch Schematic

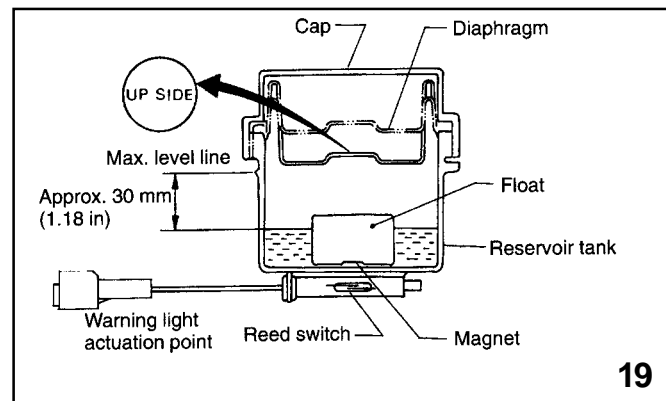

Reed Switch Construction

Brake Systems

Brake Fluid Indicator

Components consist of a reed switch which mounts below the brake fluid reservoir and a permanent magnet housed in a float inside the brake fluid reservoir. When activated, the reed switch completes a ground circuit to turn on the brake warning lamp in the combination meter. Under normal conditions, the float remains above the reed switch, and the magnetic force from the permanent magnet in the float is unable to activate it. As the brake fluid drops, and falls below a specified level, the reed switch will be activated by the permanent magnet, completing the circuit to ground. The brake warning light may light intermittently if the vehicle tilts or swings excessively.

NOTE: WHEN THE BRAKE WARNING LIGHT ILLUMINATES:

- 1) The Day Running Lights will not illuminate.
- 2) The Traction Control System will not operate.

(95 LEGACY WITH TEVES MARK IV ABS/TCS)

Typical Proportioning Valve

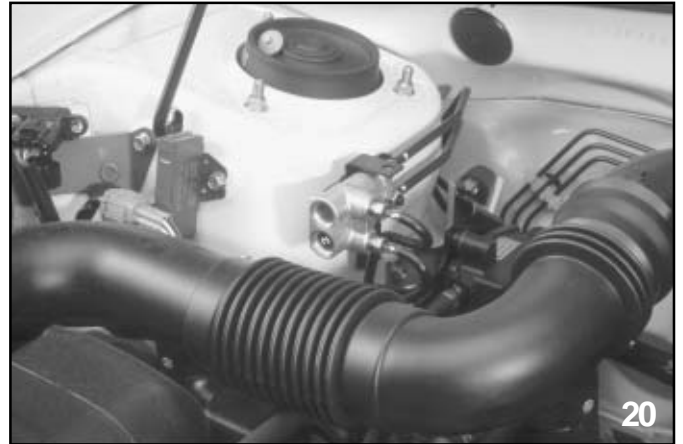

Typical proportioning valve

Another hydraulic component in Subaru brake systems is the proportioning valve.

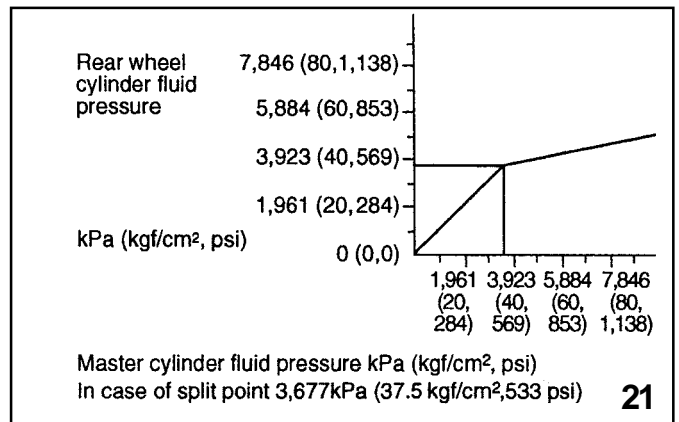

2001 Legacy Rear drum brake and VDC model

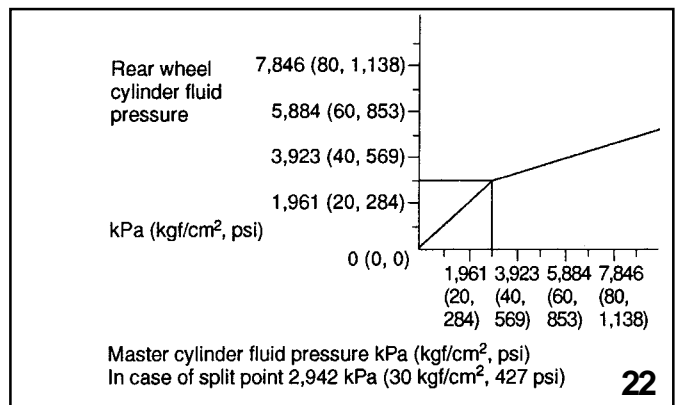

2001 Legacy Rear disc brake model

Brake Systems

The job of the proportioning valve is to reduce the possibility of rear wheel lockup. It does this by controlling the brake fluid pressure available to the rear wheel cylinders. When the pressure in the master cylinder reaches a predetermined point, called the split point, the proportioning valve limits the pressure between the master cylinder and the rear wheel cylinders. If either the primary or the secondary circuit fails, the proportioning valve will no longer control pressure to the rear wheels. The pressure in the operative circuit will remain equal to the pressure in the master cylinder.

NOTE: SPLIT POINTS MAY VARY DEPENDING ON VEHICLE TYPE AND MODEL YEAR. ALWAYS REFER TO THE APPROPRIATE MY SERVICE MANUAL FOR THE CORRECT SPLIT POINT SPECIFICATIONS.

Brake Booster

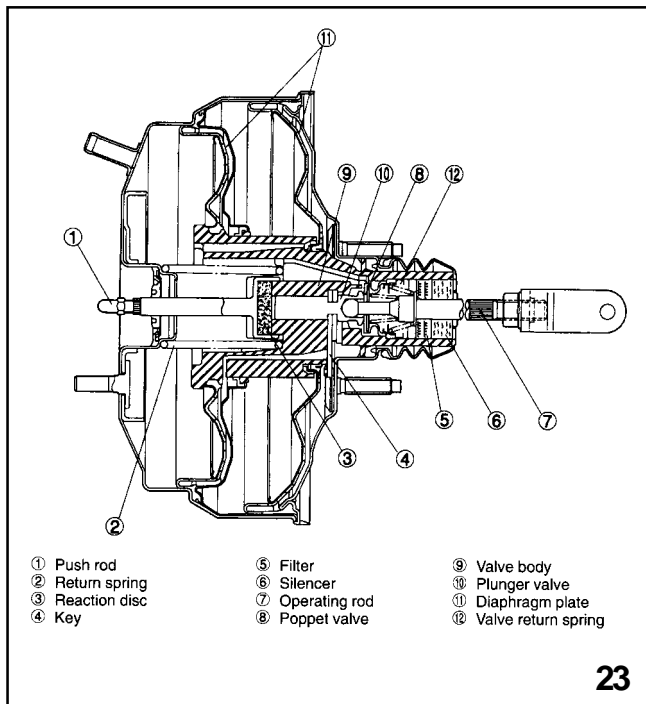

- | | | |
|-----------------|-----------------|-----------------------|
| ① Push rod | ⑤ Filter | ⑨ Valve body |
| ② Return spring | ⑥ Silencer | ⑩ Plunger valve |
| ③ Reaction disc | ⑦ Operating rod | ⑪ Diaphragm plate |
| ④ Key | ⑧ Poppet valve | ⑫ Valve return spring |

Brake booster

The brake booster, which is attached to the master cylinder, provides vacuum assist to the brake pedal. Manifold vacuum provides the negative pressure to one side of a diaphragm that is connected to the brake pedal linkage. Atmospheric pressure then assists in pedal application. A check valve in the vacuum line traps the vacuum in the booster unit. This ensures booster operation even when manifold vacuum is low.

NOTE: THE BRAKE BOOSTER IS NON-SERVICEABLE AND MUST BE REPLACED AS A UNIT. THE CHECK VALVE MAY BE REPLACED SEPARATELY.

Check the booster operation by following the steps listed below:

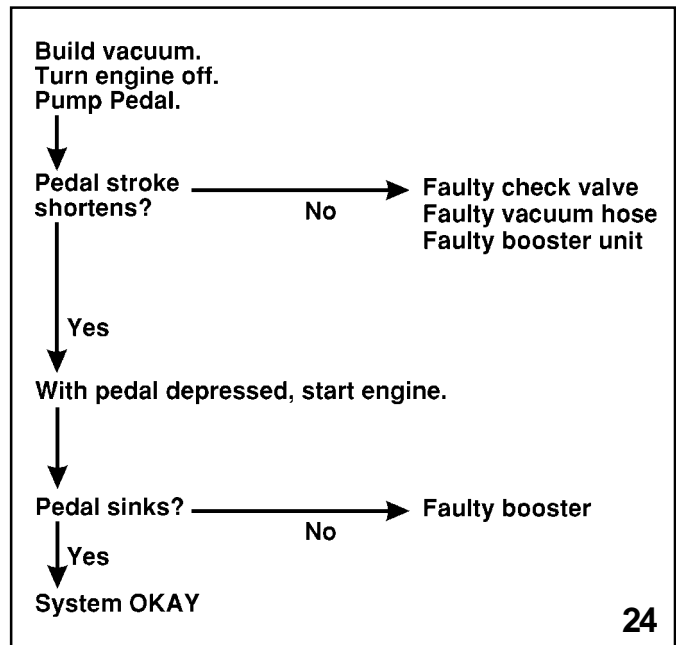

Booster check

Brake Systems

Disc Brake Inspections



Measuring rotor thickness

When servicing disc brakes, always make the following inspections: Measure the pad thickness, rotor thickness, rotor runout, and rotor parallelism.

Parallelism

thickest rotor measurement – thinnest rotor measurement \leq .0008

A visual inspection will probably suffice for determining the remaining pad thickness, but rotor thickness should be measured near the center of the rotor with a micrometer. Specifications for rotor thickness may vary from year to year, so consult the appropriate service manual for proper specifications.

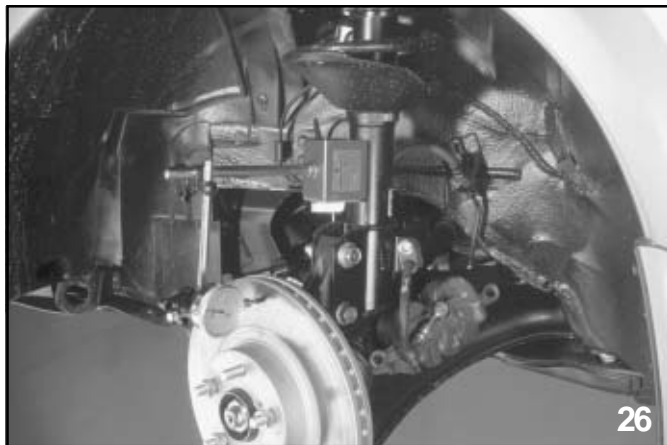

Measuring rotor runout

Rotor runout should be measured within 0.20 inches (5mm) of the outer edge of the rotor. Consult the service manual for the acceptable runout limit. If runout is not within the acceptable limit, machine the rotor within specifications if possible. Do not machine a rotor to less than the minimum thickness stamped on the rotor. Rotor parallelism must be measured at three or more places. If your measurements vary more than .0008 inch, machine or replace the rotor.

Rotor Resurfacing

If you find it necessary to service vehicle rotors, Subaru recommends on-the-car rotor resurfacing equipment.



Rotor resurfacing

Due to the nature of brake system design, resurfacing rotors with off-the-car type brake lathes often results with customers returning to with complaints of brake vibration and judder. Resurfacing rotors on-the-car can minimize comebacks because the rotor and hub are serviced as an assembly. In this manner, stacked tolerances that may have occurred with time can be compensated for. If you a resurfacing a Subaru with a trapped rotor, on-the-car service will save the time and expense of wheel bearing replacement. Subaru has tested and recommended a rotor matching system by PROCUT. Rotor matching refers to servicing the rotor and hub as an assembly. The PROCUT PFM 900 offers quick and accurate setup while proving optimum rotor finish for brake pad break-in.

Brake Systems

ROTOR RESURFACING NOTES:

1. Remove rotor and remove any corrosion on the inner and outer hat surfaces. (Only on non-trapped design).
2. Remove any corrosion on the hub surface that mates with the rotor.
3. If the rotor must be removed after resurfacing, mark the rotor and hub so that their relative positions remain unchanged after installation.
4. Remove all metal chips from ABS wheel speed sensors and tone wheels.
5. When reinstalling wheels, use a torque wrench to tighten wheel nuts to proper specifications.

Caliper Overhaul

Whenever the brake system is inspected, the inspection should include checking the condition of the calipers. Calipers in need of repair can cause numerous brake problem including pulling to one side, reduced pad life, ABS not operating at optimum performance, and loss of brake fluid.

If the calipers are determined to be the cause of the problem, a caliper overhaul would then be necessary.

Caliper overhaul includes replacement of seals, dust boots, and rubber components of the slide mechanism. Caliper bores with minor corrosion may be cleaned up with a caliper hone. Deep pitting will require replacement of the caliper housing.

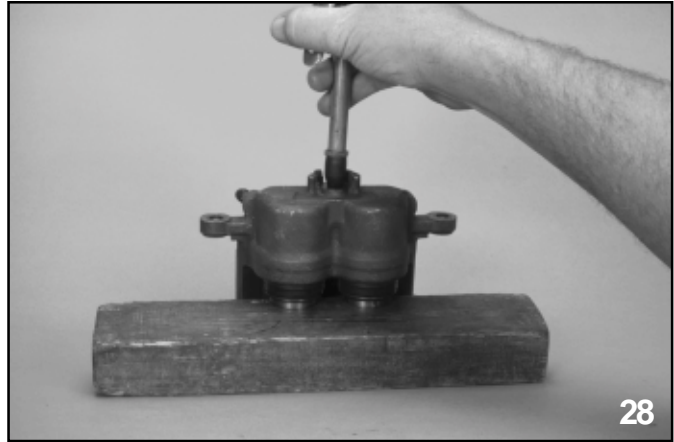

Piston removal



Caliper disassembled

NOTE THE FOLLOWING PRECAUTIONS WHEN OVERHAULING DISC BRAKES ON A SUBARU VEHICLE:

- 1) Use compressed air to gradually force the piston out of the cylinder.
- 2) To avoid injury, keep your fingers away from the piston when forcing it out of the cylinder.
- 3) Avoid scratching the cylinder wall or the piston.

Brake Systems

AFTER DISASSEMBLING THE CALIPER, MAKE THE FOLLOWING INSPECTIONS:

- 1) Check the caliper body for damage.
- 2) Check the piston for wear and damage.
- 3) Upon reassembly, use only specified greases and compounds.
- 4) Bleed the brake system after servicing.

NOTE: USE ONLY DOT 3 OR DOT 4 BRAKE FLUID.

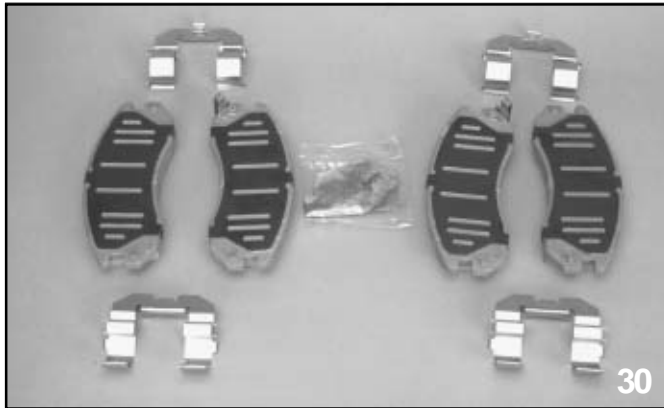

Front caliper lubrication points



Pads assembled

Brake System Inspection

To determine whether the source of a brake vibration is in the front brakes or in the rear brakes, road-test the vehicle. Follow the steps listed below:

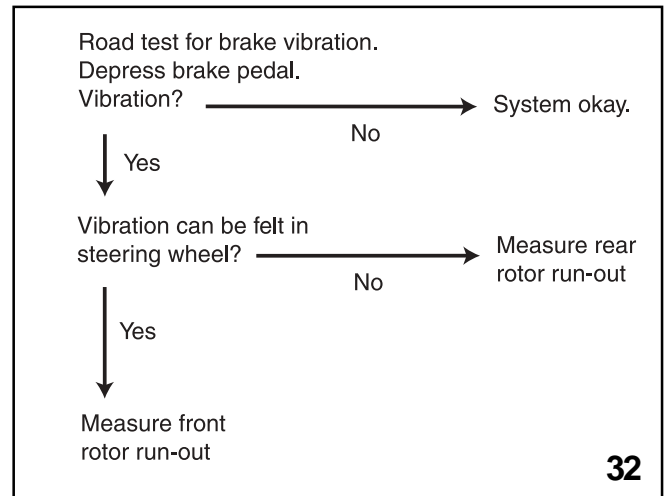

Locating brake vibration source

Rear Drum Brakes

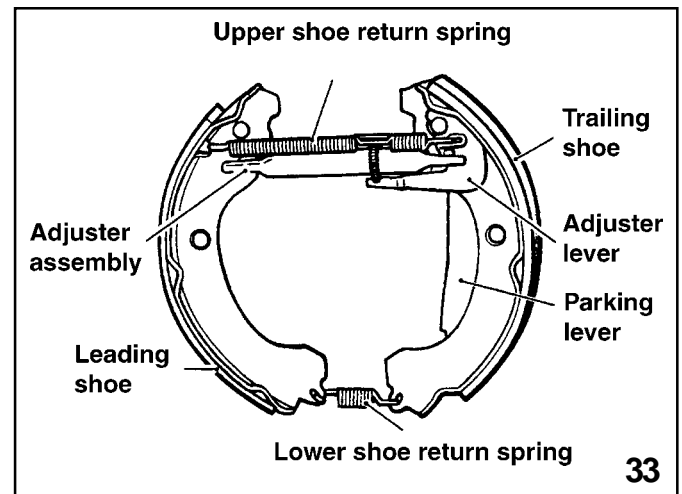

Self-adjuster operation (brakes applied)

Subaru vehicles equipped with rear drum brakes will be of the self-adjusting type. When the drum brake is activated, the self-adjuster lever travel increases. When the brake shoes are contacting, the self-adjusting lever rotates the adjuster assembly's screw to lengthen the whole assembly. This maintains clearance between the shoes and the drum to a specified value.

Brake Systems

NOTE: THE SELF-ADJUSTING MECHANISM OPERATES EACH TIME THE BRAKE PEDAL IS DEPRESSED. THE SCREW ROTATES ONLY WHEN CLEARANCE IS EXCESSIVE.

NOTE: ALWAYS RELEASE THE SELF-ADJUSTING MECHANISM BEFORE REMOVING THE DRUM.

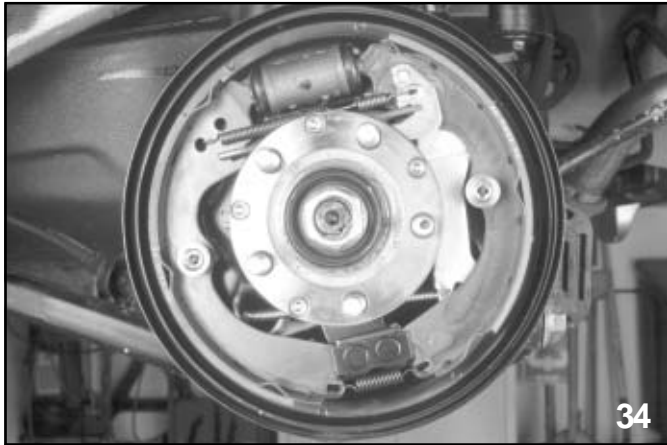

Drum brake lubrication points

When servicing rear drum brakes, follow these precautions:

- 1) Pull the drum if necessary.
- 2) Replace large and small springs in their proper positions (large spring on top, small spring on bottom).
- 3) Apply specified grease to lubrication points on the backing plate.
- 4) Apply specified grease to the contact surface of the self-adjuster and shoe and to the inside wheel cylinder boot.
- 5) If the wheel cylinder is scratched, replace it. Wheel cylinders cannot be honed.
- 6) Wheel cylinder piston seats are not replaceable separately. The seals are available with replacement pistons only.

- 7) Measure the drum diameter. Note that specifications may change from year to year. Consult the appropriate service manual for specifications.
- 8) If drums are unevenly worn, resurface them on a brake lathe.
- 9) Replace the cotter pins, lock tabs, or stake nuts with new ones.

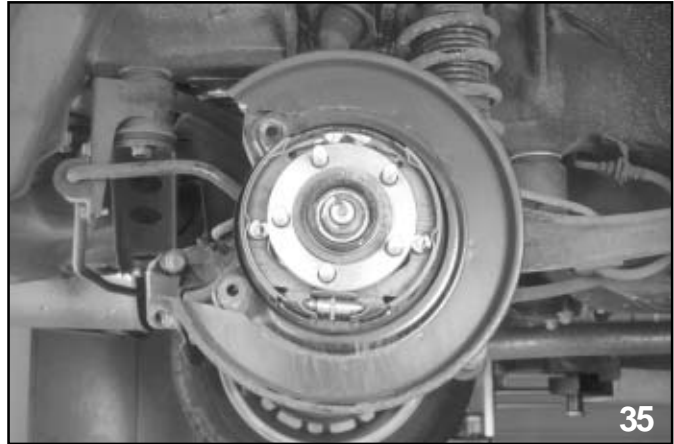

Legacy parking brake system

The Legacy, Forester, and Impreza use a rear drum type parking brake system. The drums are located in the rear disc rotors. The mechanically operated parking brake engages the shoes against the drums. When the parking brake lever is released, the shoe return spring disengages the shoes from the drum.

Brake Systems

Parking Brake Servicing Procedures

Refer to the appropriate Subaru service manual for detailed servicing procedures.

NOTE: EACH BRAKE SHOE PARKING BRAKE LEVER MUST MOVE SMOOTHLY. DO NOT CONFUSE LEFT AND RIGHT PARKING BRAKE LEVERS AND STRUTS.

Test drive the vehicle to confirm proper operation of the brake system and also to "break-in" the parking brake linings. Maintain 15 to 20 MPH and lightly pull on the parking brake lever and release. Repeat at least five times.

CAUTION: DO NOT "LOCKUP" THE REAR WHEELS, ALWAYS PULL THE LEVER SLOWLY. DO NOT PERFORM THIS OPERATION ON PUBLIC ROADS.

Check the parking brake for the proper adjustment. Always use the appropriate service manual for exact specifications. The first step is to adjust the clearance between the shoes and drum by rotating the star-wheel located on the parking brake assembly. Then, pull up on the parking brake lever and count the number of notches until resistance is felt. If the count is out of specs, adjust the length of the parking brake cable with the adjusting nut located on the parking brake lever.

General ABS Operation

The purpose of ABS is to allow the driver to maintain directional control over the vehicle during extreme braking conditions. This is accomplished by using a **Hydraulic Control Unit**, **Anti-lock Brake System Control Module**, G-Sensor and wheel speed sensors to determine impending wheel lockup. If wheel lockup is detected, hydraulic pressure to the affected wheel is modulated until wheel slip is controlled.



Hydraulic control unit

The HCU contains an electrically controlled motor plunger/pump. Depending on the ABS model, Subaru HCU's will have three, four, eight, or ten electrical solenoids to help control brake application when ABS is active. To activate a solenoid, it must receive battery voltage and a ground signal. The solenoids receive battery voltage from a valve relay. The valve relay is energized by the HCU. The HCU energizes the valve relay at vehicle start up and remains energized unless the ABSCM detects a problem in ABS circuitry. Upon seeing a fault, the ABSCM de-energizes the valve relay interrupting the power supply to the solenoids in the HCU. Under normal driving conditions, the valve relay remains energized at all times. You can see this information displayed on your Select Monitor. (Only on ABS systems that are Select Monitor compatible).

Brake Systems

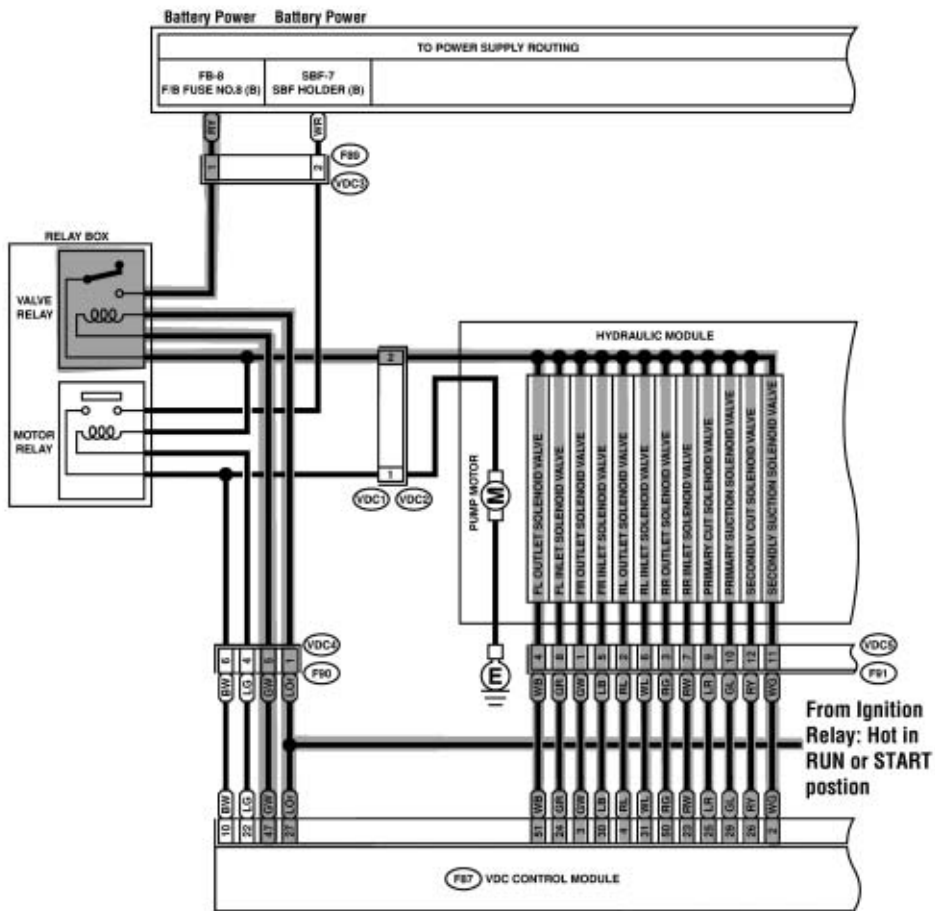

38

Valve relay circuit

The solenoids receive their ground signal directly from the ABSCM. In actual operation, the solenoid receives constant power and the ABSCM activates a solenoid by providing a path to ground.

Brake Systems

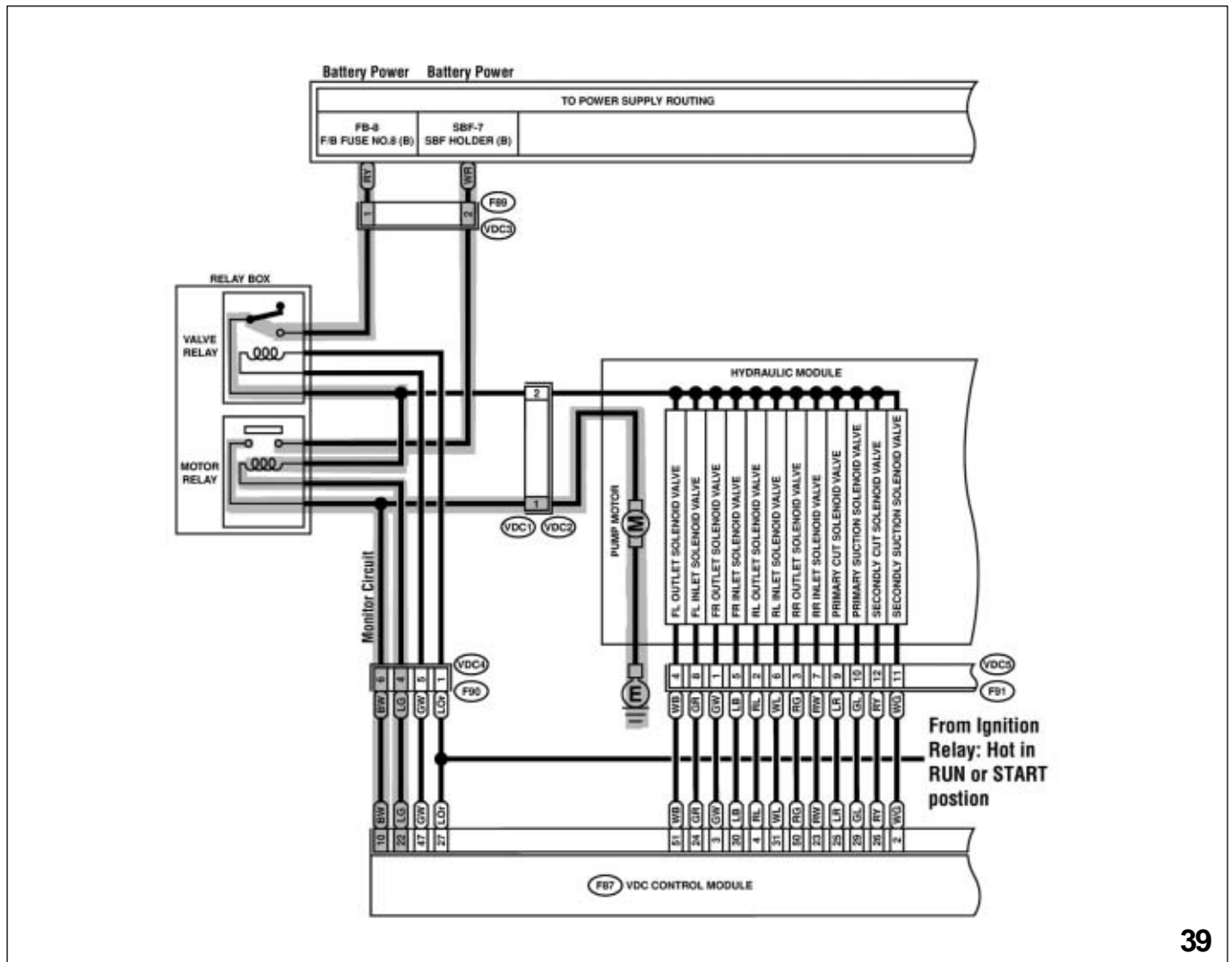

39

Motor relay circuit

The HCU's on Subaru ABS systems contain a pump motor which operates a hydraulic pump inside the HCU. The pump motor has a constant ground and receives power from a motor relay. The motor relay is energized by the ABSCM. The only time the ABSCM will energize the motor relay is when ABS is controlling the braking action of the vehicle and during a self-check during initial vehicle start and drive. This can be observed on your Select Monitor. (Only on ABS systems that are Select Monitor compatible)

Brake Systems

ABS Quick Tips

Bosch Nippon ABS2SL

- ◆ No long term memory
- ◆ Electrical faults indicated by ABS warning lamp
- ◆ Does not communicate with Select Monitor.
- ◆ Only stores 1 trouble code at a time.
- ◆ Special bleeding procedure.
- ◆ Select Low Control.
- ◆ Codes retrieved through cutout in rug underneath passenger seat.

Teves Mark IV

- ◆ Combines ABS and TCS
- ◆ Long term memory
- ◆ Electrical faults indicated by ABS or TCS warning lamp
- ◆ Communicates with SMI or SMII
- ◆ Special bleeding procedure
- ◆ Select Low Control
- ◆ Codes retrieved by grounding diagnostic terminal and Observing TCS warning lamp or by using SMI or SMII.
- ◆ Separate ABS and TCS sequence control procedures.

ABS 5.3i

- ◆ Electrical faults indicated by ABS warning lamp
- ◆ Long term memory
- ◆ Stores up to three trouble codes
- ◆ Special bleeding procedure
- ◆ Communicates with SMII
- ◆ Select Low Control
- ◆ Codes retrieved by grounding diagnostic terminal and Observing ABS warning lamp or by using SMII
- ◆ Sequence control

Nippon ABS2E

- ◆ Long term memory
- ◆ Electrical faults indicated by ABS warning lamp
- ◆ Does not communicate with Select Monitor
- ◆ Stores up to three trouble codes.
- ◆ Special bleeding procedure.
- ◆ Select Low Control
- ◆ Codes retrieved by grounding diagnostic terminal and observing ABS warning lamp.
- ◆ Sequence control

ABS 5.3

- ◆ Electrical faults indicated by ABS warning lamp.
- ◆ Long term memory
- ◆ Stores up to three trouble codes
- ◆ Special bleeding procedure
- ◆ Communicates with SMI or SMII
- ◆ Select Low Control
- ◆ Codes retrieved by grounding diagnostic terminal and Observing ABS warning lamp or by using SMI or SMII
- ◆ Sequence control

VDC

- ◆ Electrical faults indicated by ABS or VDC warning lamp.
- ◆ Long term memory
- ◆ Stores up to three trouble codes
- ◆ Special bleeding procedure
- ◆ Communicates with SMII
- ◆ Select Low Control
- ◆ Separate ABS and VDS sequence control procedures
- ◆ Special procedure to calibrate steering sensor

Brake Systems

Teves Mark IV with ABS/TCS

In 1995 Subaru introduced the Teves Mark IV Hydraulic Control Unit that featured both an anti-lock brake system and a traction control system. The two systems are interdependent and both systems will go into fail-safe if a common component or signal malfunctions. ABS/TCS is available on front wheel drive, U.S. and Canada spec 5MT or 4EAT equipped vehicles only. Manual transmission vehicles with TCS cannot be equipped with a hill-holder because of hydraulic piping layout and TCS operation.

Master Cylinder

The master cylinder inside diameter is 1 1/16 inches. There are 4 ports located on the master cylinder. (primary, secondary and 2 for ABS/TCS).

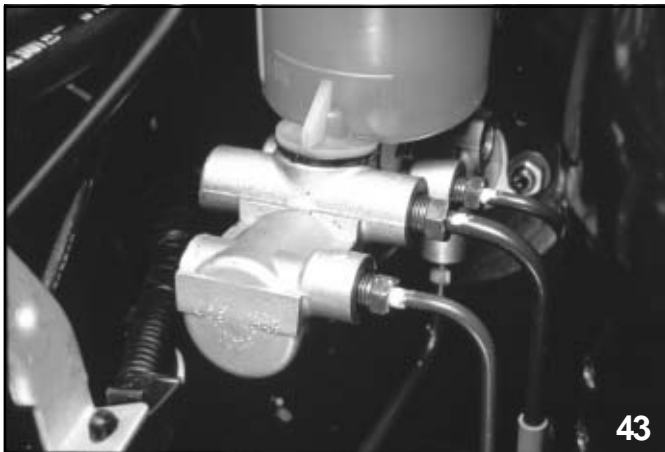

Master cylinder - Traction control

A tandem diaphragm booster is used which is 8 and 9 inches in diameter. The pushrod of the booster protrudes inside the master cylinder, resulting in zero clearance between the master cylinder and the booster.

Hydraulic Control Unit

The hydraulic control unit assists in the control of brake fluid flow during normal braking, ABS operation, and TCS operation. The HCU contains 10 solenoid valves that route the brake fluid. They are:

1. Input Front Right (IFR) normally open
2. Input Front Left (IFL) normally open
3. Input Rear Right (IRR) normally open
4. Input Rear Left (IRL) normally open
5. Output Front Right (OFR) normally closed
6. Output Front Left (OFL) normally closed
7. Output Rear Right (ORR) normally closed
8. Output Rear Left (ORL) normally closed
9. Special Valve #1 (SV1) normally open
10. Special Valve #2 (SV2) normally open

During normal braking and ABS operation SV1 and SV2 remain off (open). During TCS operation, SV1 and SV2 will turn on (closed). Each solenoid has a check valve connected in parallel with it to aid in the flow of fluid. (The solenoid design restricts flow.)

The HCU contains a motor sensor which monitors the rotation of the motor armature and produces a sine wave (2 volts peak to peak), which is sent to the ABS/TCS control module to judge motor operation.

The motor and pump assembly is used to modify brake fluid pressure during ABS operation. The motor and pump assembly activate during TCS and the pressure rise mode of ABS. Pressure generated while in the rise mode is used to apply the brakes. The motor and pump assembly will also activate during TCS operation, supplying brake fluid pressure to the left front and /or right front calipers, which is decided by the control module, to control wheel slip.

The pressure switch monitors the pressure generated by the master cylinder. The control module uses the signal from the switch to suspend TCS operation if any pressure is generated by the master cylinder. (brake applied by the driver)

Brake Systems

The motor relay controls motor operation via the control module.

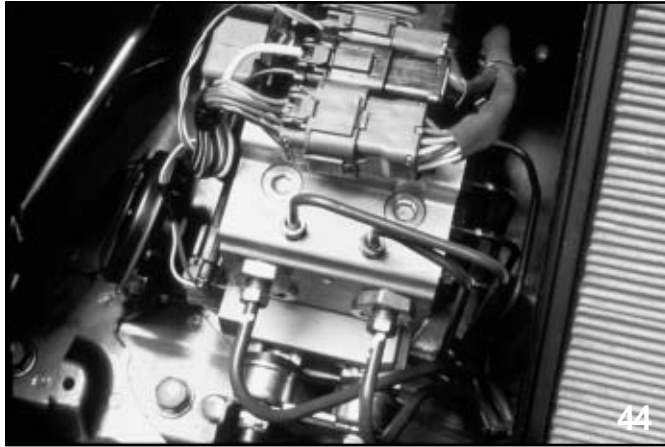

Teves Mark IV Hydraulic Control Unit

The valve relay controls the power supply to the ten solenoids inside the hydraulic control module.

Brake Pedal Stroke Sensor



Brake pedal stroke sensor

A brake pedal stroke sensor is located at the top of the brake pedal. The sensor produces signals for the ABS/TCS control module when the brakes are applied. It consists of six 100 ohm resistors wired in series, a movable contact, and five stationary contacts. The normal resistance at rest is 100 ohms. The operating range of the sensor is 100-500 ohms. The sensor allows the control module to monitor how much effort is applied to the brake pedal. In operation, the control module will cancel TCS operation if any effort is applied to the brake pedal. (backup for the pressure switch)

Wheel Speed Sensors

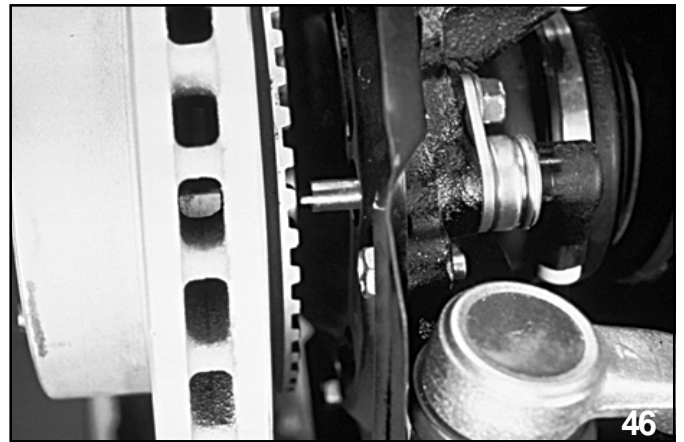

Wheel speed sensor / tone wheel

Wheel speed sensors and tone wheels, which are located at each wheel, generate a sine wave which is sent to the control module. The control module then calculates the wheel speed for each individual wheel.

Combination Meter



Combination meter

The combination meter contains three lamps that will give information about ABS/TCS system to the driver. They are the ABS warning lamp, the TCS warning lamp, and the TCS operation lamp.

The ABS warning light will illuminate:

1. During the light check cycle
2. During a D-check or read memory check
3. Sequence control
4. ABS malfunction

Brake Systems

The TCS warning light will illuminate:

1. During the light check cycle
2. TCS malfunction

The TCS operation lamp will illuminate:

1. During the light check cycle
2. While TCS is controlling the acceleration of the vehicle

TCS Off Switch



TCS off switch

There is a TCS off switch located in the dash to the left of the steering wheel. The TCS off switch is used to disengage the TCS system under conditions that it is being triggered frequently. (space saver spare tire being used) The TCS off switch is also used during the air bleed procedure.

A light in the TCS off switch will illuminate under the following conditions:

1. During the light check cycle
2. When the TCS off button has been pushed (momentary contact switch)
3. Excessive TCS operation in a short amount of time (driver continually trying to free the vehicle from snow or mud. This can overheat the brake pads and rotor. As a result. The control module will shut down the TCS to allow brake components to cool.)

ABS/TCS Control Module



ABS/TCS control module

The ABS/TCS control module controls the application of ABS and TCS vehicle functions. It also networks with the engine control module during TCS operation and networks with the transmission control module during ABS operation.

Brake Systems

Hydraulic Flow

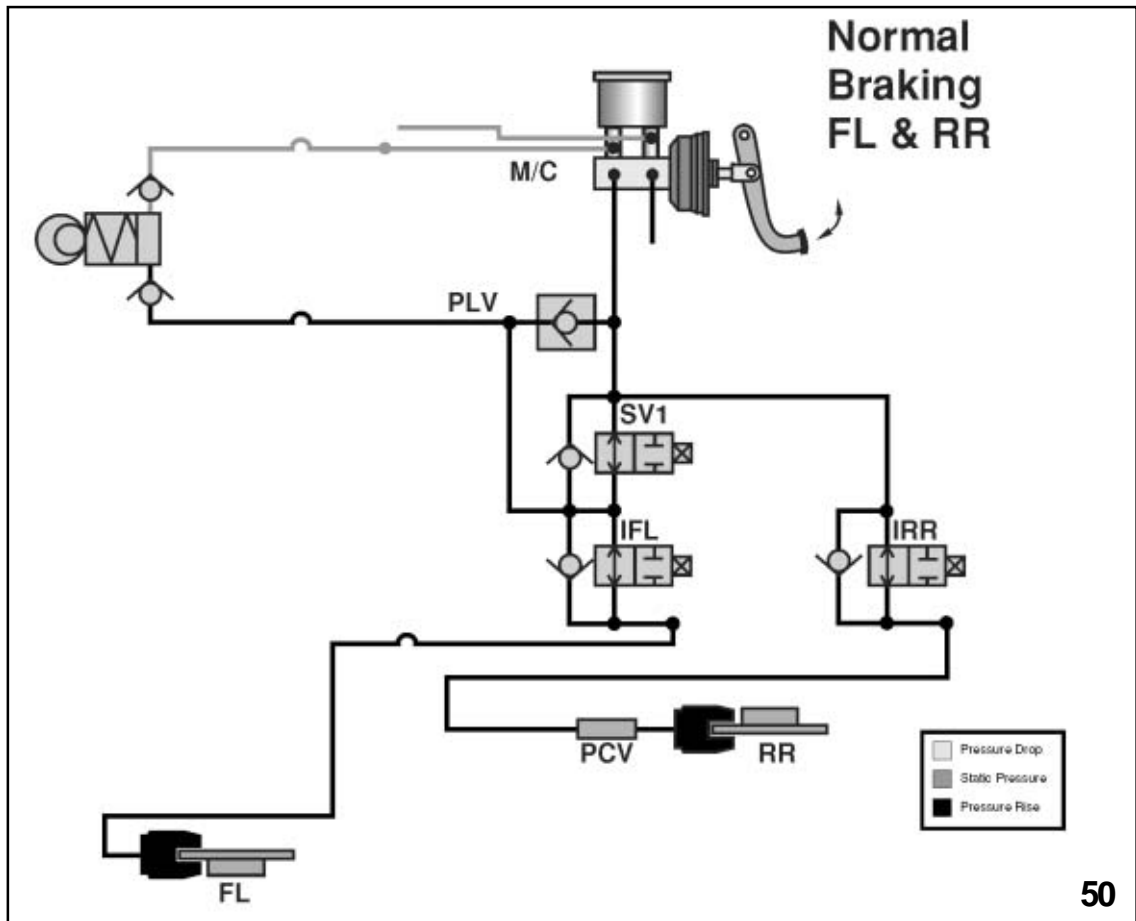

Normal braking

Normal braking – Pressure generated from the master cylinder is routed into the HCU. Fluid then flows to the IRR and through SV1, pressure from SV1 is routed into the IFL and applies the brake. Pressure from the IRR goes through the PCV and applies the rear brake. The PCV is the proportioning valve and performs the same function as past model years. The check valves are used to provide additional flow past the solenoid valves.

Brake Systems

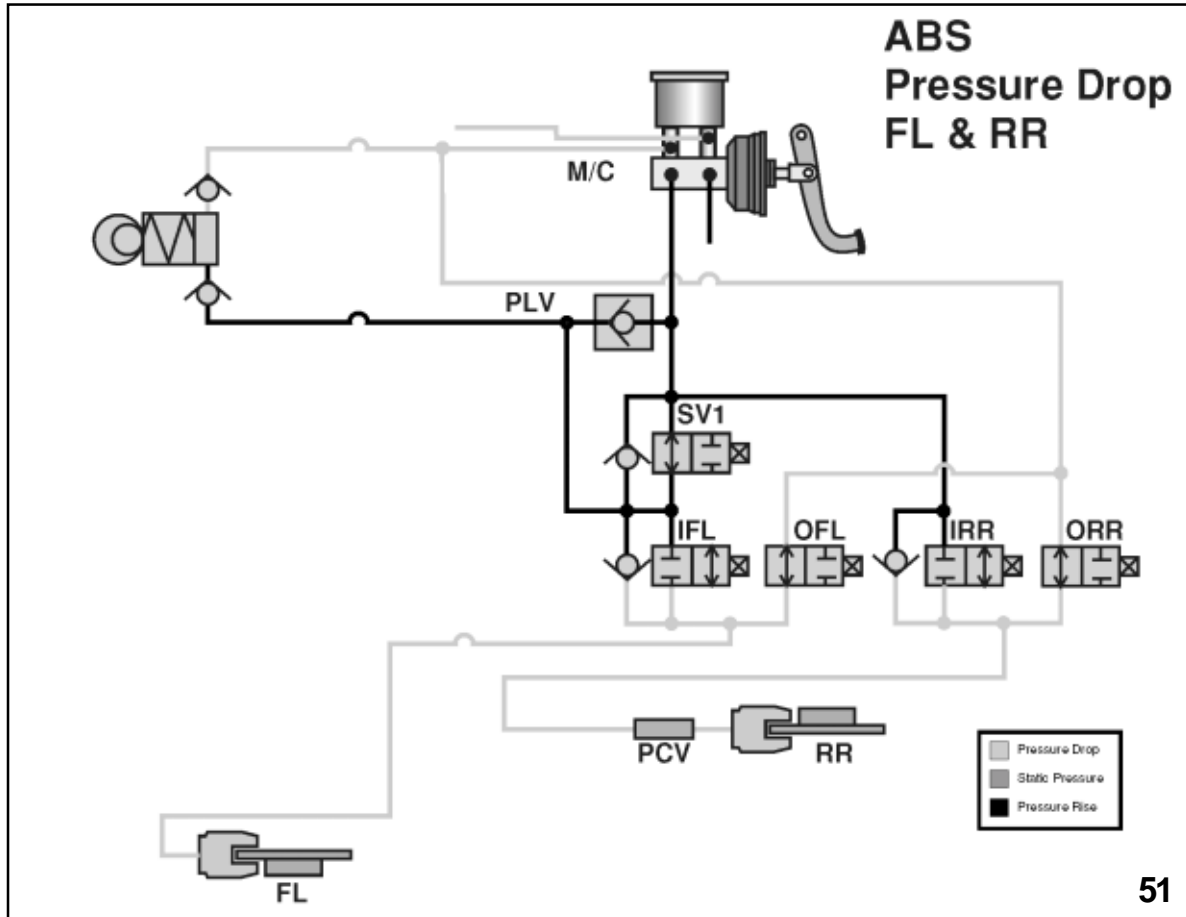

ABS braking pressure drop

ABS Braking Approaching Wheel Lock-up – Pressure drop occurs first. IFL closes, preventing master cylinder pressure from reaching the caliper or wheel. The ABS/TCS control module immediately memorizes the position of the brake pedal from the brake pedal sensor. The OFL opens and reduces the pressure in FL caliper, by providing a passage to the master cylinder reservoir. The lock-up is avoided and the wheel accelerates, the ABS/TCS now enters pressure hold mode.

Brake Systems

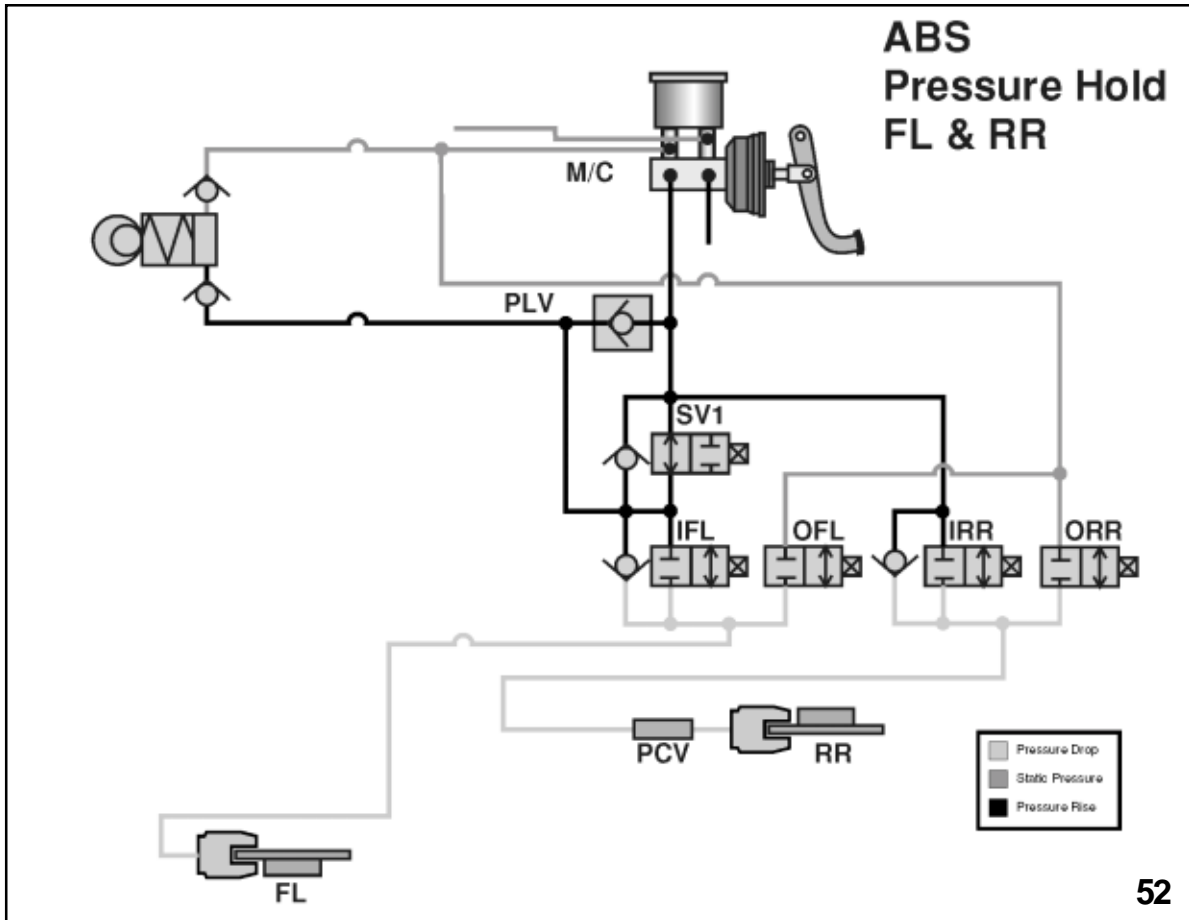

ABS braking pressure hold

Pressure Hold – The IFL and OFL close, trapping the remaining pressure in the brake caliper. Wheel speed is then reevaluated, and the ABS/TCS will enter pressure rise or drop, depending on whether the wheel need to accelerate or decelerate.

Brake Systems

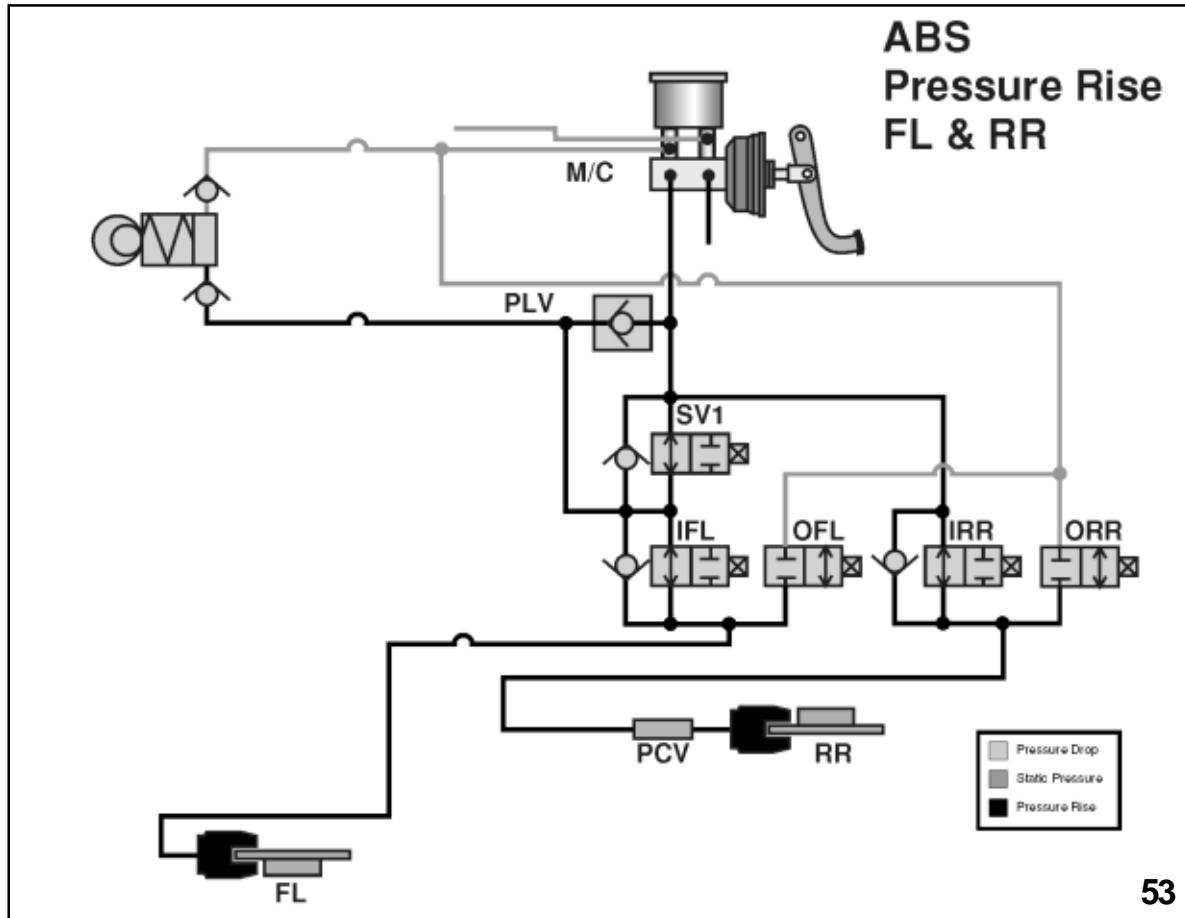

ABS pressure rise

Pressure Rise – The OFL remains closed, IFL opens and the brake pedal begins to move toward the floor. The motor pump assembly activates and pressurizes the hydraulic circuit from the caliper to the master cylinder. At this point the pump output pressure is approximately 150 kg/cm², which overcomes the approximately 100 kg/cm² produced by the master cylinder, and pushes the pedal away from the floor and applies the brake. The pump will continue to operate until the pedal is repositioned to the memorized location which occurred in the pressure drop mode. This action produces brake pedal kick back. Pressure drop, hold, and rise will continue until the wheel speed is nominal.

Brake Systems

TCS Operation

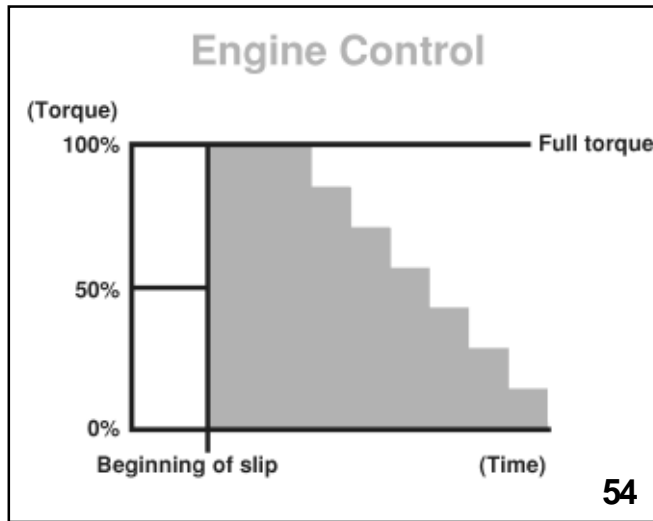

TCS Logic - Engine Control

TCS improves and controls acceleration on low friction road surfaces, or when one of the driving wheels unloads creating wheel slip. The fuel and brake systems are used together to eliminate wheel slip. The objective of the TCS system is to supply the maximum driving torque to the front wheels. Monitoring of the driving torque is accomplished by observing wheel speed sensor signals. The ABS/TCS control module compares the front wheels (driving) to the rear wheels speed, which represents true wheel speed, to judge wheel slip. Wheel slip is more critical in certain driving conditions than in others. Example: Initial acceleration (high slip) and cruising (low slip), the ABS/TCS control module has nine different programs that will respond to various driving conditions.

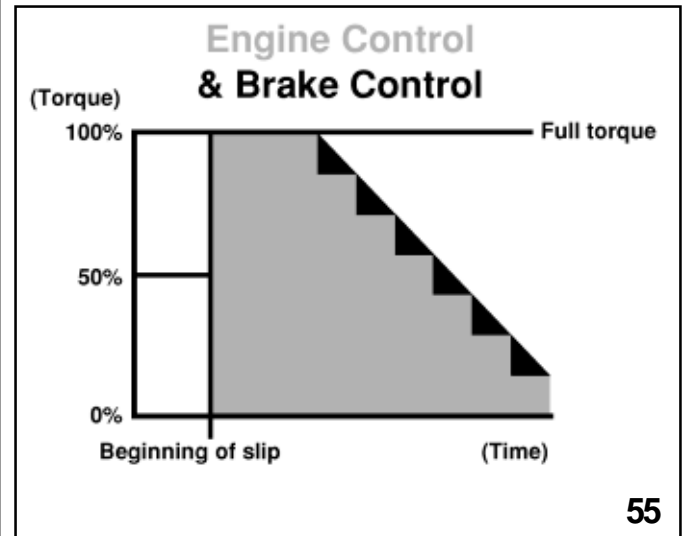

TCS Logic - Engine Control & Brake Control

Traction control is accomplished by a networking of control units. The ABS/TCS control module recognizes wheel slip, picks the program that will best begin control of it and sends a signal to the fuel injection control module. Fuel injectors are cut (turned off) to reduce engine torque. This is called "engine control". This action alone would produce a vibration at low vehicle speeds while in low gear ratios. To counteract the vibration, the ABS/TCS control module sends signals to the HCU to apply the brake while the engine is recovering from fuel cut. The braking action called "brake control", slows down a slipping wheel or wheels. Combined with engine control, provides a constant decrease in driving torque.

Torque, which would otherwise transmit to the slipping wheel, in the case of a one wheel slip, is now transferred through the differential to the wheel with traction. This is called a "limited slip differential effect".

Brake Systems

Logic

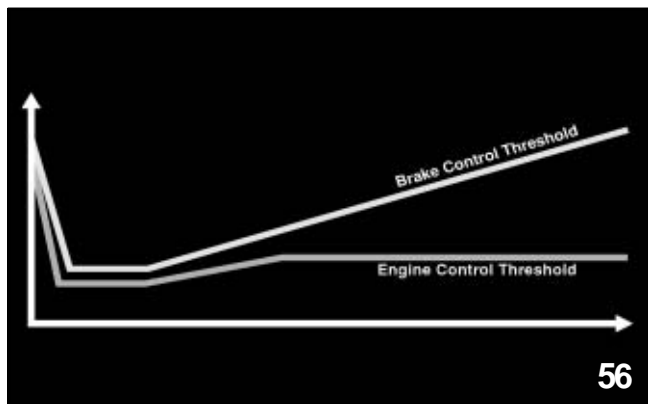

TCS Logic / Wheel slip recognition

The ABS/TCS control module recognizes one or two wheel slip under 31mph. This aspect of TCS concentrates on acceleration. When vehicle speeds are above 31mph, the TCS will focus on vehicle stability in the event of wheel slip and therefore will only recognize two wheel slip. The amount of fuel cut during engine control is dependant on vehicle speed and wheel slip speed. Large wheel slip conditions result in large fuel cuts while small wheels slips result in small fuel cuts. Initial acceleration wheel slips are not recognized until wheel slip speed is 5mph. Vehicle speeds over 31 mph have slightly higher wheel slip speed recognition.

Braking control during TCS operation results in approximately 10% of the total available braking force of the vehicle. Braking control initially occurs just after fuel cut and logic braking control wheel slip recognition parallels fuel cut wheel slip recognition until 31mph. Vehicle speeds over 31 mph result in higher braking control wheel slip recognition than engine control. The means that braking control will be delayed to give engine control time to reestablish control. This results in improved vehicle stability.

One-Wheel Slip

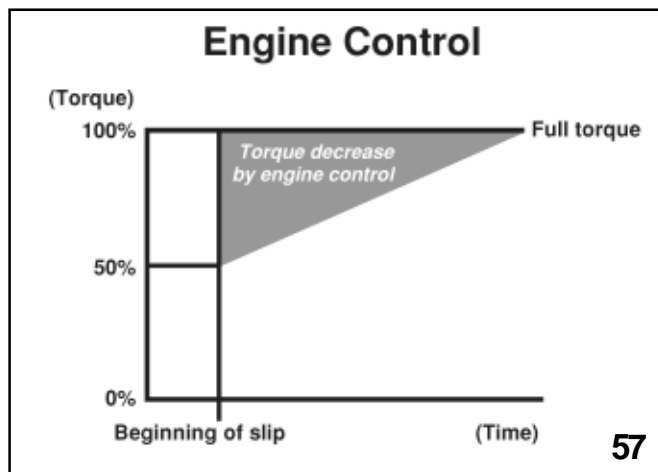

TCS Logic - One wheel slip

TCS engine control is determined by the severity of the wheel slip and the number of wheels slipping. One wheel slip results in a large fuel cut at first and is quickly reduced to restore torque to the wheel with traction. This concentrates on acceleration.

Two-Wheel Slip

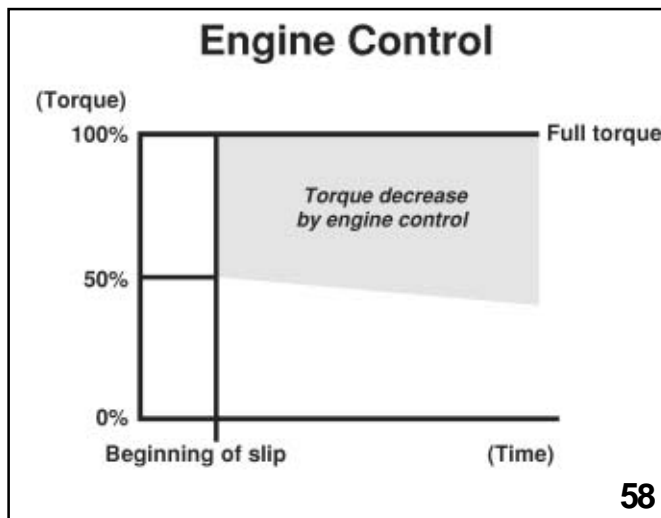

TCS Logic - Two wheel slip

Two wheel slip results in a large fuel cut at first and increases if the slip does not decrease and decreases if the wheel slip decreases. This concentrates on stability.

TCS brake control is also determined by the severity of wheel slip.

Brake Systems

TCS Hydraulic Control

When TCS activates, SV1 and SV2 turn on and close, isolating the rear calipers so that no braking can occur in the rear. The motor and pump assembly turn on, pressurizing the brake circuit. The IFR will close if a left wheel slip is detected, allowing no braking on the FL. The IFL will close if the right wheel slip is detected, allowing no braking on the FL.

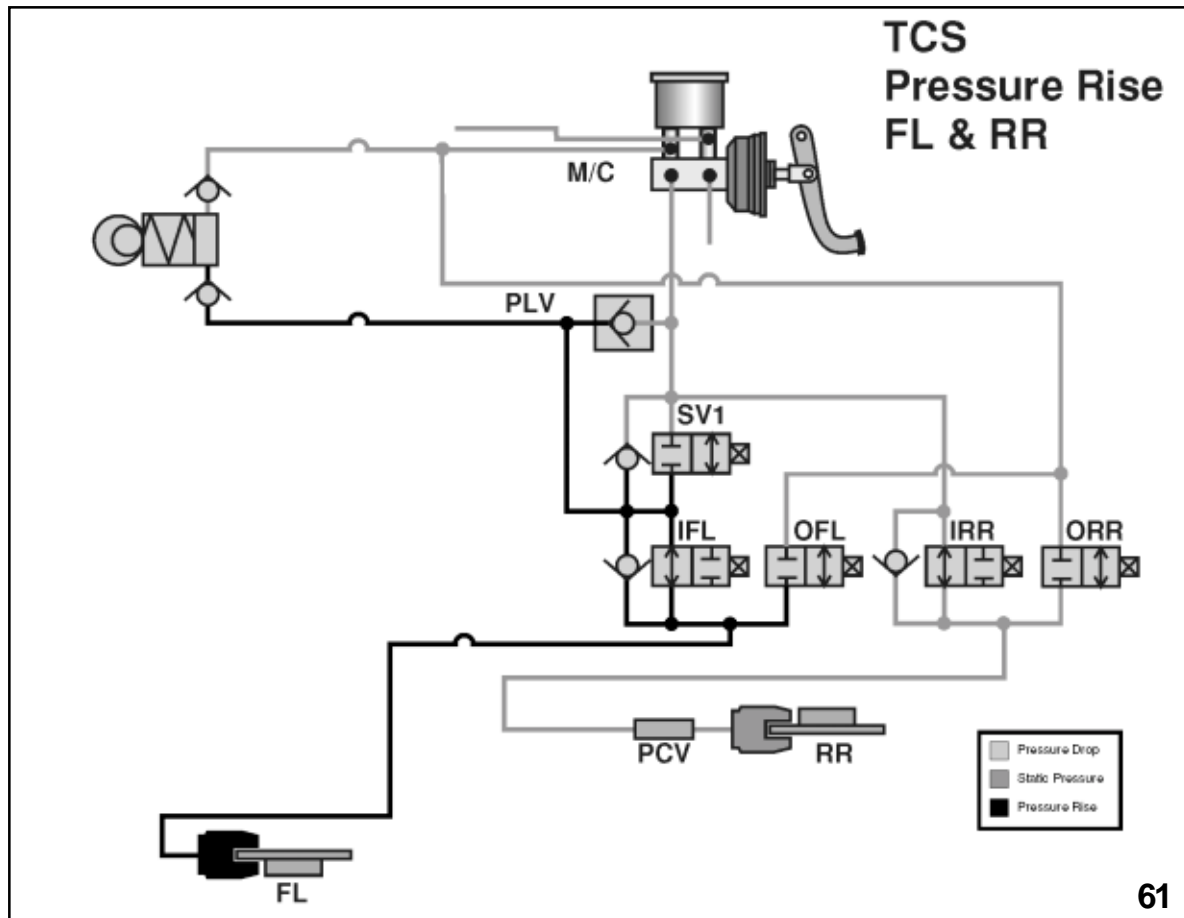

TCS pressure rise

Two wheel slip will result in both inlet valves remaining open, allowing braking on the FR and FL wheels. When braking occurs during one wheel slip, the driving torque that would otherwise go to the slipping wheel is transmitted through the differential to the wheel with traction, creating a **Limited Slip Differential Effect**. During two wheel slip, the objective is to slow down both wheels, reducing driving torque.

Brake Systems

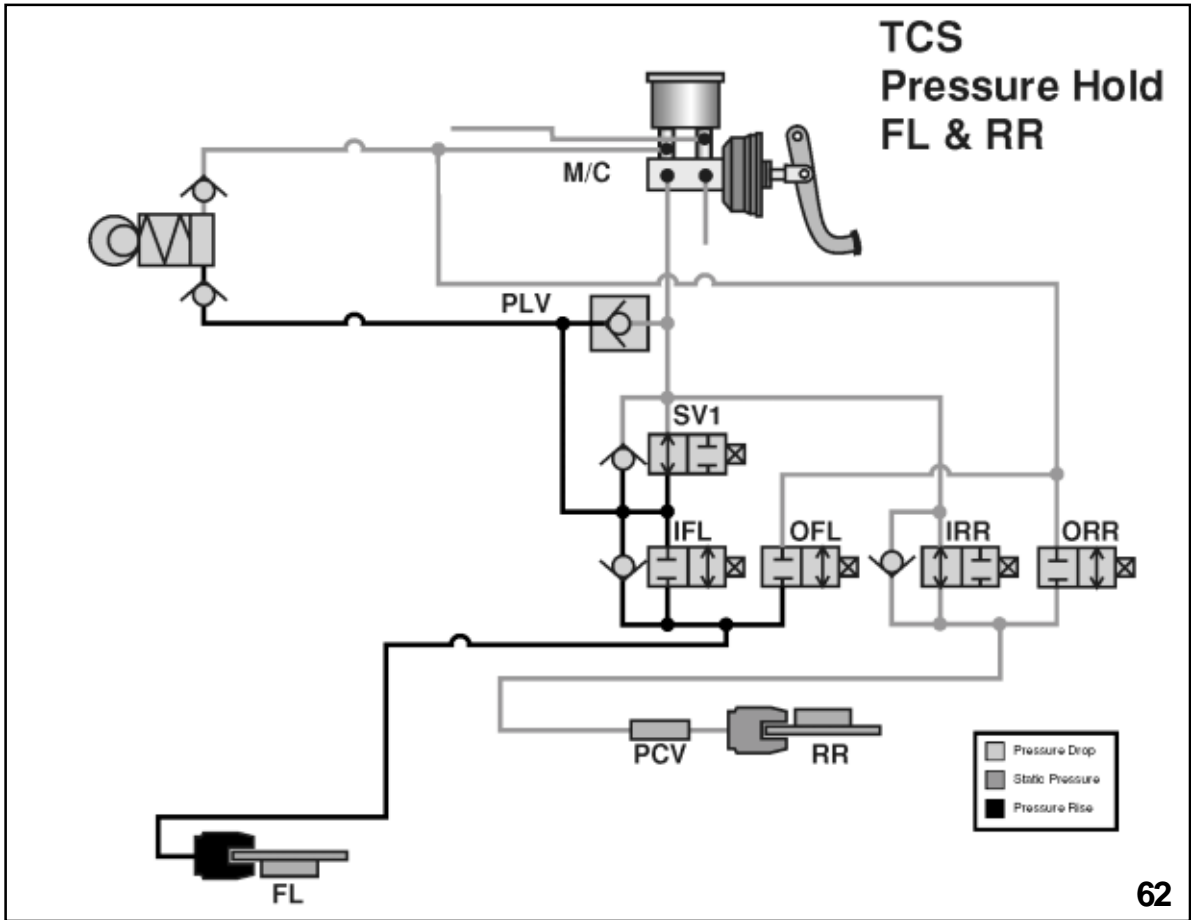

TCS pressure hold

Brake Systems

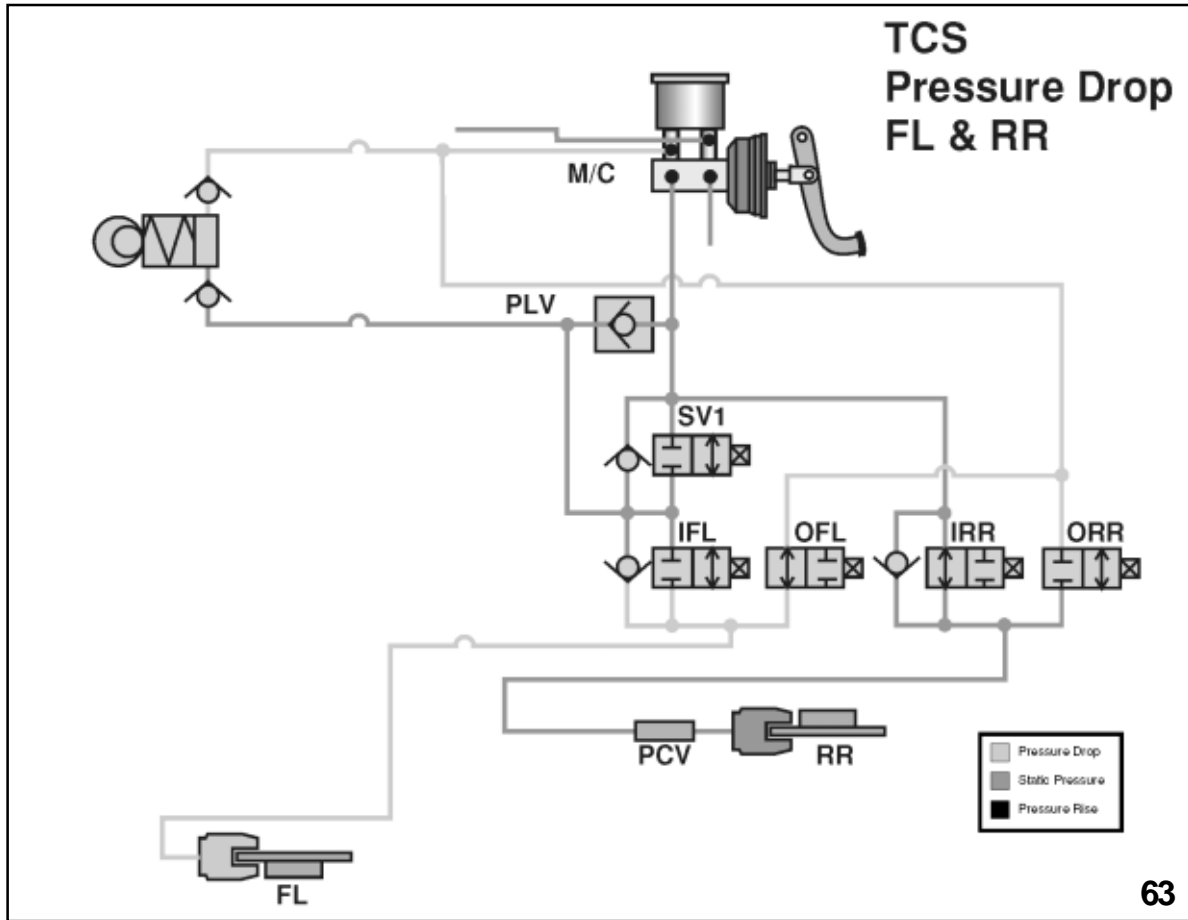

TCS pressure drop

Brake Systems

Teves Mark IV Diagnostics

Diagnostics begin with verifying the complaint and doing a thorough visual inspection. The following steps should help you diagnose most complaints that did not cause an ABS or TCS warning light to illuminate. This can also help you in cases that no trouble code was stored in the memory of control unit.

1. Check battery voltage to insure battery is fully charged
2. Inspect tires for proper sizing. Ideally, all four tires should be of the same make, model, and size
3. Check air pressure in all four tires and set to specifications.
4. Check all four wheels for excessive brake drag. This could indicate sticky pistons or caliper slides.
5. Inspect all hydraulic lines for leaks and make needed repairs.
6. Inspect wheel bearings for excessive play and make needed repairs.
7. Top off brake fluid level if necessary.
8. Perform ABS and TCS sequence control procedures and compare your results to specifications in service manual.

Access Trouble Codes

Trouble codes can be accessed with your NSM or by using the diagnostic connector located under the dash to the right of the steering wheel.

NOTE: THE NEW SELECT MONITOR IS THE PREFERRED METHOD FOR ACCESSING TROUBLE CODES AND INITIATING OTHER SERVICE PROCEDURES. MORE INFORMATION ON USING THE DIAGNOSTIC CONNECTOR CAN BE FOUND IN THE BRAKES SECTION OF THE 1995 LEGACY SERVICE MANUAL SERVICE MANUAL.

If codes are stored, trouble shoot according to the diagnostic charts in the service manual.

Perform the clear memory procedure with the NSM.

Test drive vehicle and verify that ABS and TCS warning lamps remain off.

Verify that no additional trouble codes have been stored.

Brake Systems

Sequence Control

On Subaru vehicles equipped with ABS/TCS, there is a procedure called sequence control that can be performed. Sequence control has two basic functions. Sequence control allows the technician to check the mechanical condition of the pump and solenoids inside the ABS/TCS hydraulic control unit. The second function is to help purge air from ABS/TCS hydraulic control unit during a brake bleeding procedure.

There are two separate sequence control procedures that can be used on ABS/TCS equipped vehicles. The first procedure allows you to check the ABS side of the system while the second procedure allows you to check the TCS side of the system. Both sequence control procedures can be accomplished with the NSM. Go to section 4-4 page [W20D0] and [W20F0] of the 1995 Legacy service manual for instructions on how to perform sequence control with the Select Monitor. Below are normal results for ABS and TCS sequence control.

ABS Sequence Control Specifications

	Initial Value	When Decompressed	When Compressed
Front Wheel	3,432 kPa (35 kg/cm ² , 498 psi)	490 kPa (5 kg/cm ² , 71 psi) or less	981 kPa (10 kg/cm ² , 142 psi) or more
Rear Wheel	3,432 kPa (35 kg/cm ² , 498 psi)	490 kPa (5kg/cm ² , 71 psi) or less	981 kPa (10 kg/cm ² , 142 psi) or more

TCS Sequence Control Specifications

	Initial Value	When Compressed	When Decompressed
Front Left Wheel	490 kPa (5 kg/cm ² , 71 psi) or less	1,471 kPa (15kg/cm ² , 213 psi) or more	490 kPa (5 kg/cm ² , 71 psi) or less
Front Right Wheel	490 kPa (5 kg/cm ² , 71 psi) or less	1,471 kPa (15 kg/cm ² , 213 psi) or more	490 kPa (5 kg/cm ² , 71 psi) or less

Brake Systems

Air Bleed Procedures

NOTE: TO THOROUGHLY BLEED THE HYDRAULIC SYSTEM THE FOLLOWING PROCEDURE MUST BE STRICTLY FOLLOWED. SKIPPING STEPS MAY RESULT IN AIR REMAINING IN THE SYSTEM. THE BRAKE PEDAL SHOULD BE DEPRESSED SLOWLY WITH AT LEAST 3 SECONDS BETWEEN EACH APPLICATION. FOR CONVENIENCE AND SAFETY, IT IS ADVISABLE TO HAVE TWO TECHNICIANS WORKING

1. Start air bleed operation with the Select Monitor. Refer to section 4-4 [W19C0] or [W19D0] of the 1995 Legacy service manual.
 2. Bleed air through RF caliper by depressing the brake pedal.
 - a) Fit one end of a vinyl tube onto the air bleeder and keep the other end submerged in a container with brake fluid.
 - b) Slowly depress the brake pedal and keep it depressed. Then, open the air bleeder to discharge air together with the fluid. Release air bleeder for 1 to 2 seconds. Next with the bleeder closed, slowly release the brake pedal. Repeat these steps until there are no more air bubbles in the vinyl tube.
 3. Bleed air from suction pipe through RF caliper.
 - a) Open the air bleeder.
 - b) Keep depressing the TCS OFF switch for 20 second or more. Ensure no air comes out from bleeder.
 - c) Close the air bleeder.
 4. Bleed air through LF caliper by following step 2 above.
 5. Bleed air from suction pipe through LF caliper by following step 3 above.
 6. Bleed air through RF and LF calipers by operating brake pedal. This is the same procedure as step 2 above. Repeat steps 2 thru 6 until air no longer comes out.
 7. Bleed air through RR and LR calipers by operating brake pedal. This is the same procedure as step 3 above.
 8. Operate Right Front Outlet valve and Left Rear Outlet valve to bleed air from their specific circuits.
 - a) Press TCS OFF switch while depressing brake pedal
 - b) Make sure ABS warning light illuminates
 - c) Depress and release brake pedal slowly 10 times or more while depressing the TCS OFF switch.
 9. Operate Left Front Outlet valve and Right Rear Outlet valve to bleed air from their specific circuits.
 - a) Press TCS OFF switch while depressing brake pedal.
 - b) Make sure TCS warning light illuminates.
 - c) Depress and release brake pedal slowly 10 times or more while depressing the TCS OFF switch.
- NOTE: WHILE PERFORMING STEPS 8 AND 9, AIR WILL BE RELEASED THROUGH BRAKE FLUID RESERVOIR. THE OPERATIONS IN STEPS 8 AND 9 CAN BE SWITCHED WITH EACH OTHER BY DEPRESSING THE BRAKE PEDAL WHILE DEPRESSING THE TCS OFF SWITCH. EACH TIME THE TCS OFF SWITCH IS DEPRESSED WITH THE BRAKE PEDAL DEPRESSED. YOU WILL SWITCH FROM ONE DIAGONAL, (RF/LR) TO THE OTHER. (LF/RR)**
10. With all procedures completed, fully depress the brake pedal for approximately 20 seconds to make sure there are no leaks in the entire system.
 11. Turn off the ignition switch.
 12. Perform TCS sequence control.

Brake Systems

Vehicle Dynamic Control (VDC)

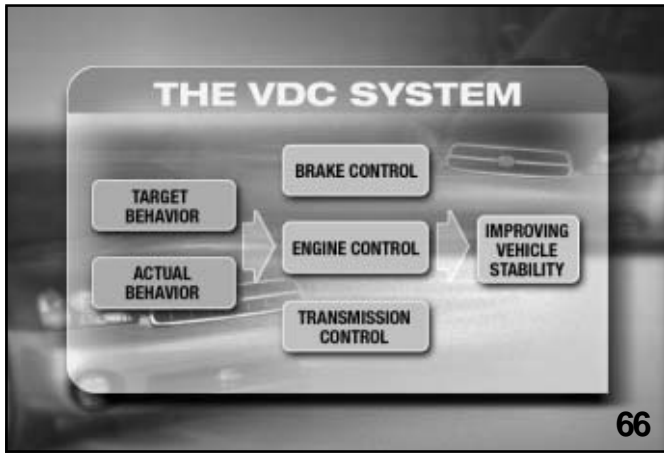

VDC Logic

Vehicle Dynamic Control or VDC combines Anti-lock Brakes, Traction Control and new vehicle stability logic. The VDC system is designed to keep the vehicle behavior in the driver's expectations when the actual vehicle behavior may divert from what is expected.

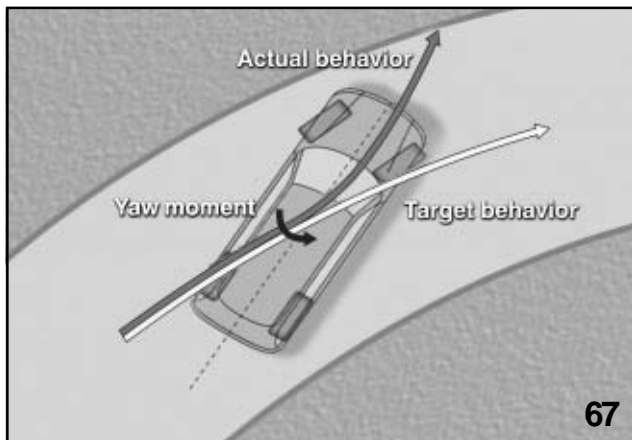

Understeer

VDC operation comes into use during periods of driving when understeer or oversteer conditions are encountered. Four wheel TCS and ABS functions become active any time the VDC CM determines they are needed.

Understeer is the result of a movement of the vehicle where the driver's intent is to make a change in direction and while the steering wheel is turned the vehicles direction changes little or not at all. This is due to the front wheels slipping across the road surface.

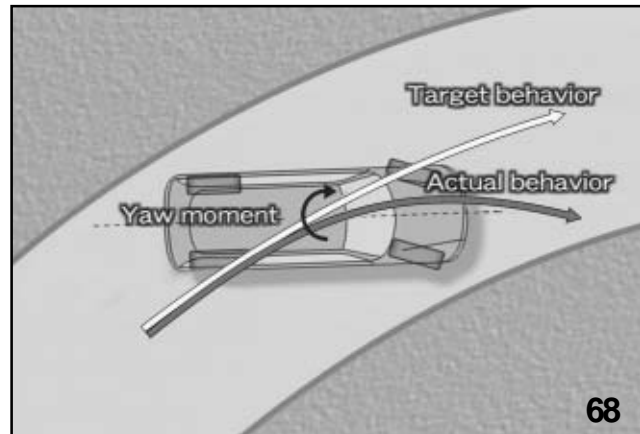

Oversteer

Oversteer is the result of a movement where the driver's intent is to make a change in direction. While the vehicle is doing so, the amount of change is too great. This is due to the rear wheels slipping across the road surface.

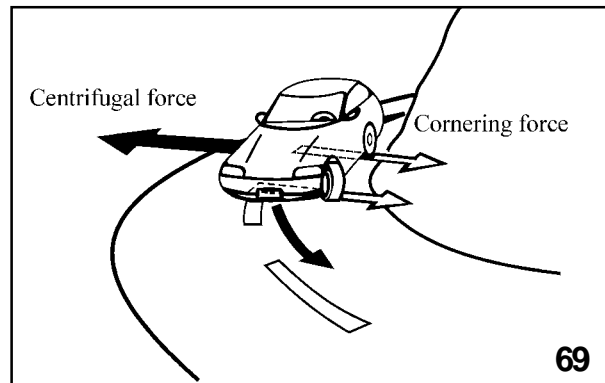

Cornering force

Slip occurs whenever a vehicles' cornering force is less than it's centrifugal force. The cornering force is a combination of vehicle weight, tire quality, design, and the road surface.

There are two ways to control slip: Produce a force or yaw moment of the reverse direction in the case of oversteering or produce a yaw moment of the same direction as the turning direction in the case of understeering.

Brake Systems

These two slip controls can be utilized by three systems acting independently or together.

They are:

- Brake control by utilizing the hydraulic control unit
- Engine torque control with the ECM
- Torque distribution control for the front and rear wheels working with the TCM.

Oversteering and understeering can occur with the accelerator depressed, brake pedal depressed or with no pedal depressed. In each case, the response from the VDC CM is customized to the driving conditions of the vehicle and the resulting vehicle response.

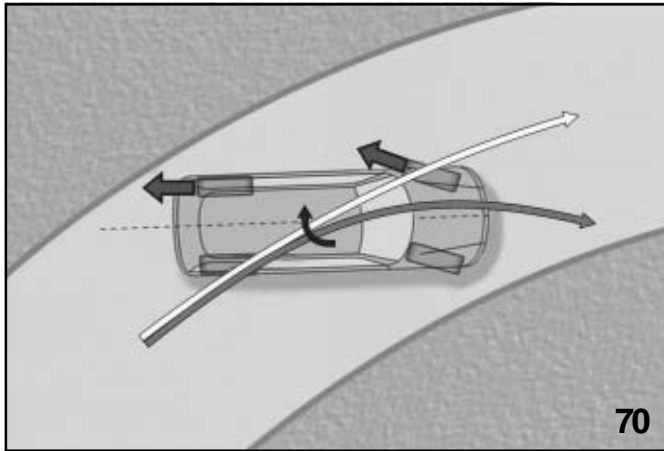

Oversteer While Accelerating

Oversteering while depressing the accelerator pedal

Correction required: Stop the rear wheels from slipping outward, and maintain the front of the vehicle towards the intended path.

Actions taken:

1. Apply strong brake force to the front outer wheel.
2. Apply weak brake force to the rear outer wheel.
3. Increase the transfer clutch engagement.
4. Decrease engine torque by fuel cut.

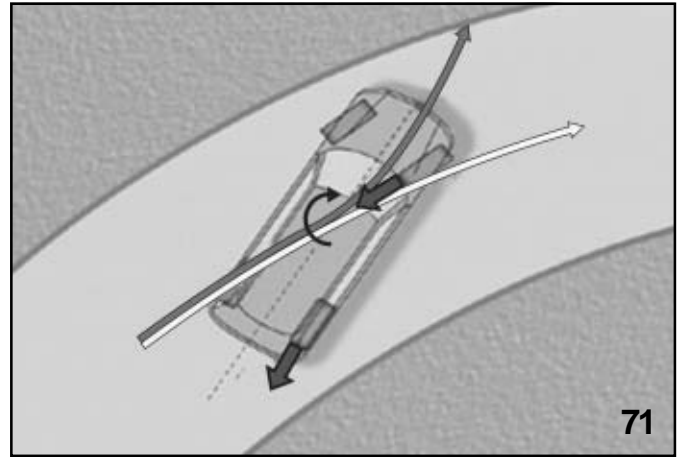

Understeer While Accelerating

Understeering while depressing the accelerator pedal.

Correction required: Stop the front wheels from slipping outward and return the front of the vehicle to the intended path.

Actions taken:

1. Apply weak brake force to the front inner wheel.
2. Apply strong brake force to the rear inner wheel.
3. Release the connection of the transfer to increase driving force distribution ratio to the rear wheels.
4. Decrease engine torque by fuel cut.

Brake Systems

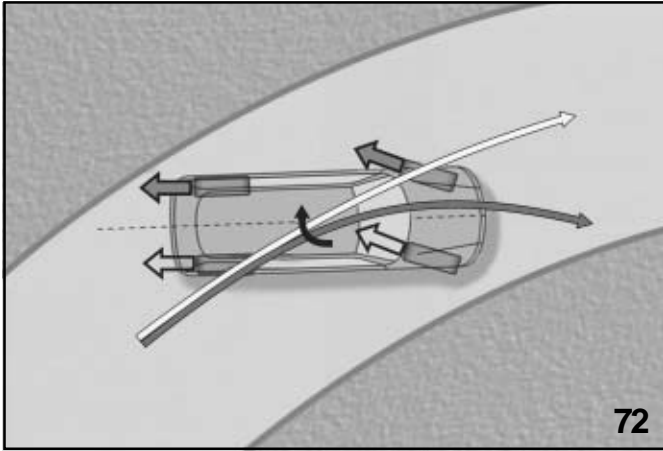

Oversteer While Braking

Oversteering while applying the brake.

Correction required: This is the same situation as the ABS system operating and understeering condition is needed.

Actions taken:

1. Loosen the brake for the front inner wheel.
2. Loosen the brake for the rear inner wheel.

If the braking force applied by the driver is insufficient, VDC operates creating hydraulic pressure by the pump to increase the braking force on the front outer wheel.

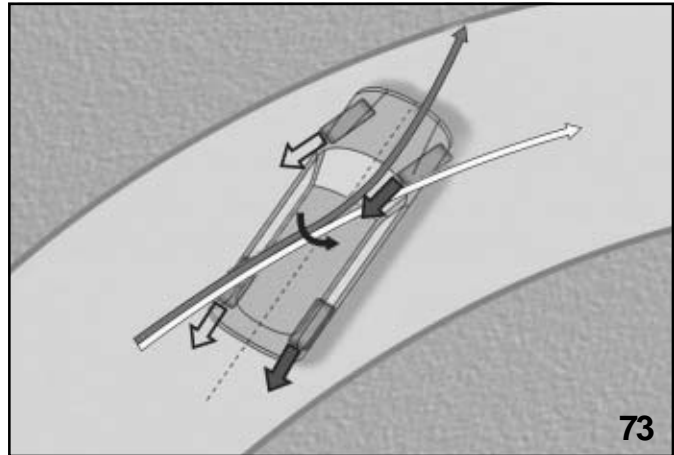

Understeer While Braking

Understeering while applying the brake.

Correction needed: This is the same as the ABS system operating and oversteering condition is needed.

Actions taken:

1. Loosen the brake for the front outer wheel.
2. Loosen the brake for the rear outer wheel.

If the braking force supplied by a driver is insufficient, VDC operates creating hydraulic pressure by the pump, to increase the braking force on the rear inner wheel.

Brake Systems

Sensors

Steering Position Sensor

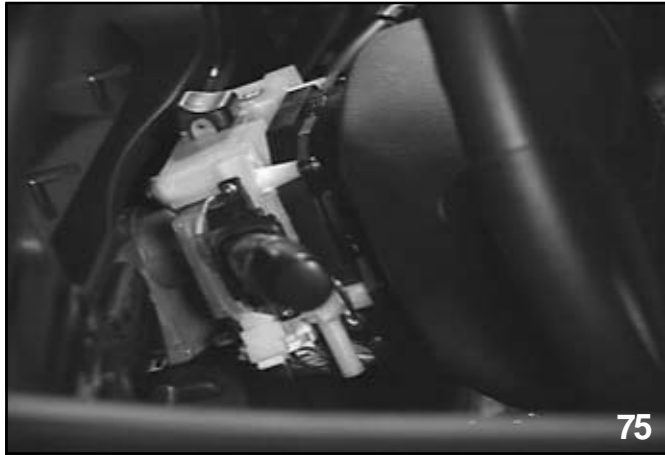

Steering position sensor

This sensor is located under the steering wheel and is indexed with it to create signals as the steering wheel is turned.

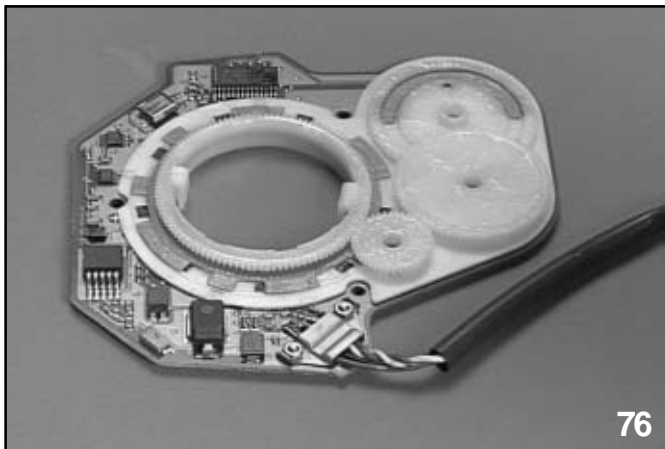

Steering position sensor construction

The internal make up of the sensor consists of two sensing elements.



Steering position sensor waveform

The first is made of a large reluctor with nine hall elements. The positioning of the reluctor over the hall elements creates signals that are sent to the VDC CM control unit that when combined with the second sensing element communicate the position of the front wheels. The output of the steering wheel position is displayed in 2.5-degree increments. The full range of steering wheel detection is 720 degrees.



Degrees of turn

360 degrees to the right which shows up as positive and 360 degrees to the left shows up as negative. The movement of the second sensing element tells the control unit to go negative or positive and communicates the number of steering wheel revolutions.

Brake Systems



Wheel Speed Sensor

Wheel Speed Sensor-Detects wheel speed by each wheel.



Yaw Sensor

Yaw Rate Sensor- Detects the rotating velocity of the vehicle body during turning.

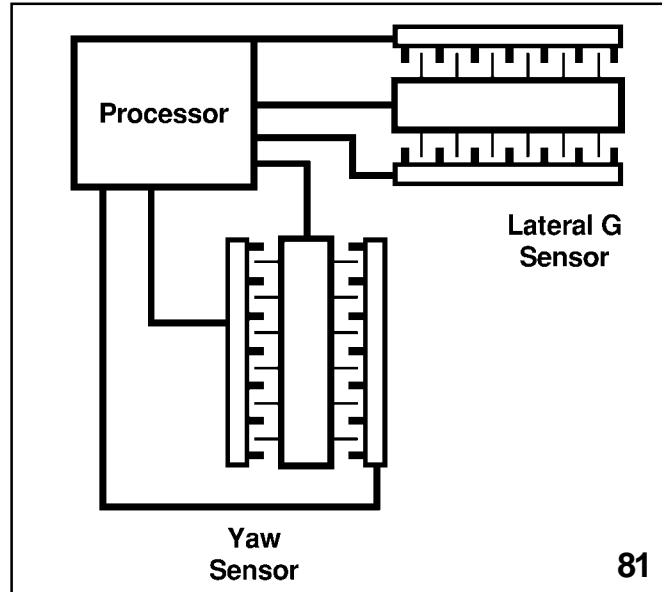

Yaw Sensor (artwork)

Lateral G Sensor- measures the centrifugal force exerted on the vehicle.

These two sensors are housed in a single unit and is located in the center console near the hand brake.

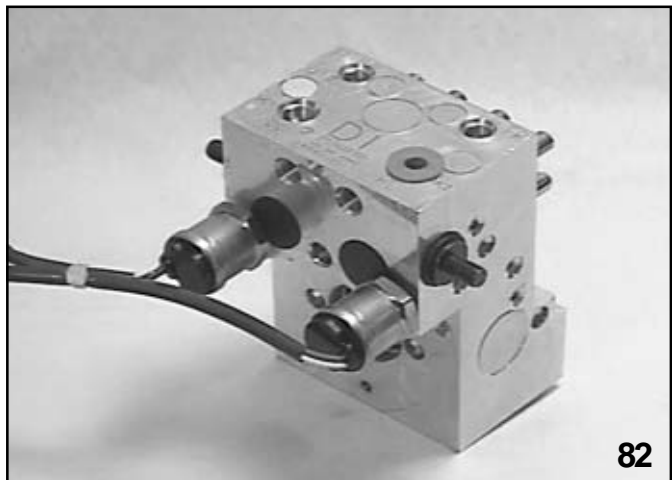

Hydraulic Control Unit

Brake pressure Sensor- Measures the estimated braking force applied to each wheel applied by the driver.

Brake Systems

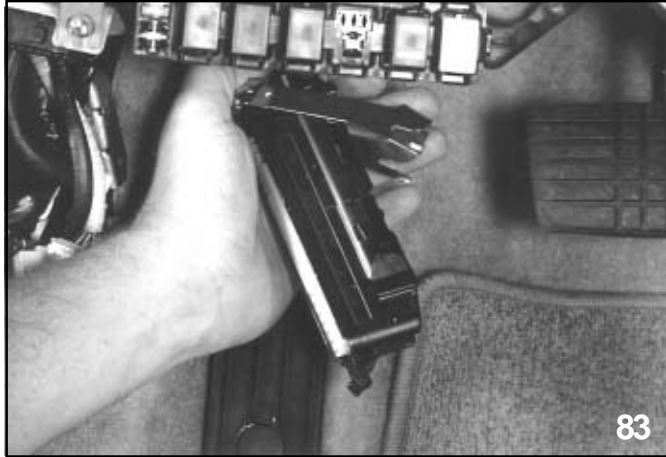

VDC CM connector

Input signals from the VDC CM determines the calculated driving force applied to the wheels.



VDC CM location

Signals from the TCM- Using front to rear split information combined with VDC CM information determines the driving force of the engine or braking applied to the wheels.

Hydraulic operation during ABS and or VDC operation when the brake pedal is depressed.

Pressure reducing mode

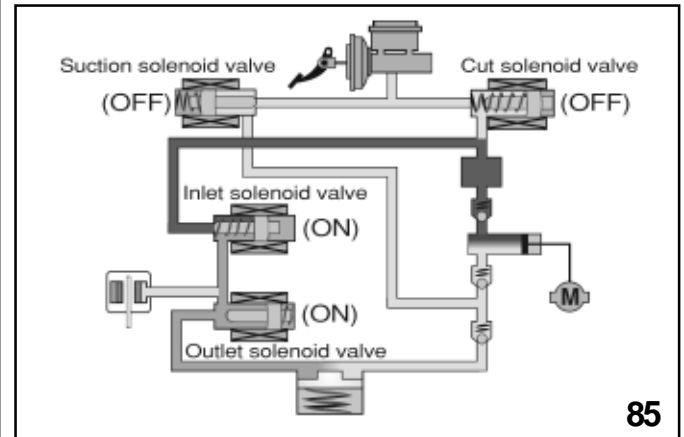

Pressure reducing mode

When the wheels are about to lock due to the braking action, instructions are issued from the control module and power is supplied to the EV and AV solenoid valves. The EV valve closes, cutting off the master cylinder pressure and wheel cylinder pressure. The AV valve opens reducing the wheel cylinder pressure and power is simultaneously supplied to the motor at this time. The brake fluid temporarily is collected in the reservoir and is sucked out by the self sucking pump, passed through the damper chamber, where pulsations are absorbed and is then returned to the master cylinder side. In this way; a pressure-reducing control is performed with the fluid pressure in the wheel cylinder side being completely separated from that in the master cylinder.

Brake Systems

Pressure holding mode

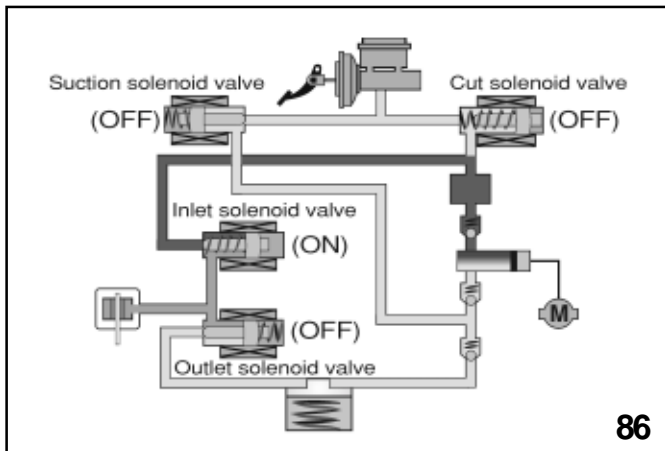

Pressure holding mode

When the optimum wheel cylinder fluid pressure is obtained, power is supplied to the solenoid valve (EV valve) according to VDC CM instructions. The valve closes, cutting off the master cylinder pressure and the wheel cylinder side.

Pressure increasing mode

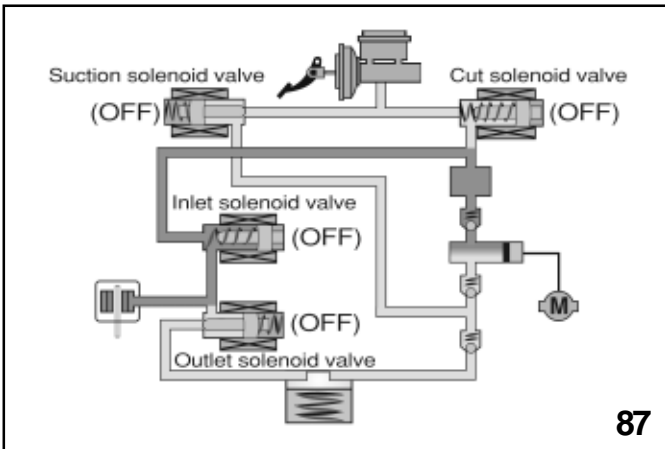

Pressure increasing mode

When the wheel cylinder pressure needs to be increased, power to the solenoid valves are turned off according to VDC CM instructions, resulting in normal braking conditions. Pressure is then applied by the master cylinder.

TCS operation and or VDC operation when the brake pedal is released

Pressure increase mode

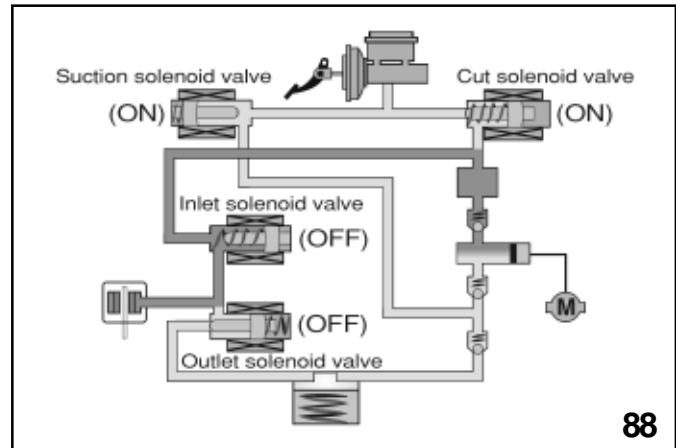

Pressure increasing mode

When the wheels slip while driving, or slip occurs while the vehicle is turning, instructions are issued by the VDC CM and the VDC/TCS control is initiated. Power is supplied to the USV and HSV valves. The USV valve closes and the HSV valve opens at the same time. Power is also supplied to the motor, and the brake fluid in the master cylinder reservoir is sucked through the HSV valve by the self sucking pump, passing through the EV valve and pressurizing the wheel cylinder side.

Brake Systems

Pressure holding mode

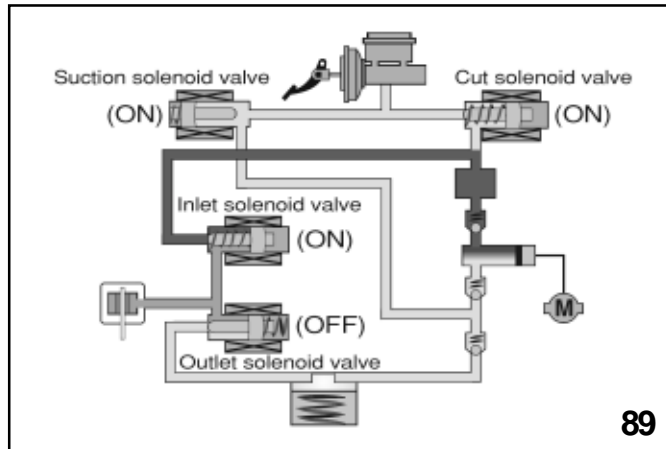

Pressure holding mode

When the optimum wheel cylinder fluid pressure is obtained, power is supplied to the EV valve according to VDC CM instructions. The USV valve, HSV valve and motor power supply conditions are not changed. The EV valve is closed, cutting off the brake fluid pressurized by the self-sucking pump. The brake fluid pressurized by the self-sucking pump is then passed through the USV relief valve and returned to the master cylinder.

Pressure reducing mode

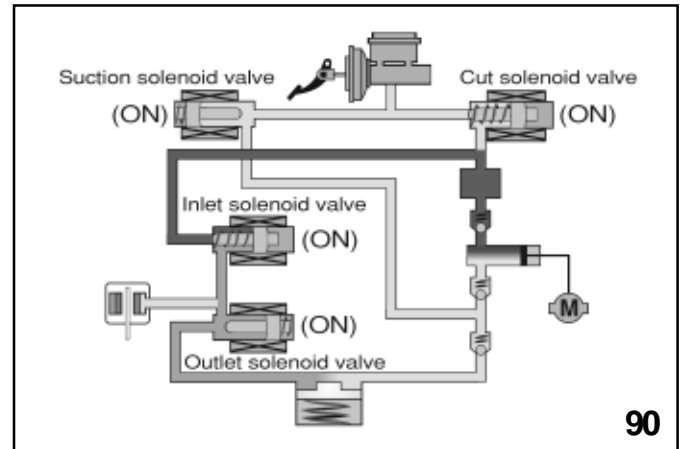

Pressure reducing mode

When the wheel cylinder fluid pressure must be reduced, power is supplied to the EV valve and AV valve according to VDC CM instructions. The USV valve, HSV valve and motor power supply conditions are not changed. The EV valve is closed and the AV is opened. The wheel cylinder fluid pressure is discharged to the master cylinder side through the reservoir and HSV valve, reducing the pressure on the wheel cylinder side. The brake fluid pressurized by the self-sucking pump is passed through the USV relief valve and returned to the master cylinder.

Brake Systems

VDC light operation

During the light check cycle all lights will illuminate for a short time.

- VDC Operation (Car with tire tracks)
- VDC
- VDC OFF
- ABS

During VDC operation the VDC Operation light (car with tire tracks) will blink.

During TCS operation the VDC Operation light (car with tire tracks) will be on solid.

A malfunction with the VDC system will illuminate just the VDC light.

A malfunction with the ABS will illuminate the ABS and VDC light.

A malfunction with the ECM or TCM will illuminate the VDC Off light.

A fuse placed in the VDC slot in the fuse box will illuminate the VDC Off light.

VDC Diagnostics

VDC diagnostics begin with verifying the complaint and doing a thorough visual inspection. The following steps should help you diagnose most complaints that did not cause an ABS or VDC warning light to illuminate. This can also help you in cases that no trouble code was stored in the memory of control unit.

1. Check battery voltage to insure battery is fully charged
2. Inspect tires for proper sizing. Ideally, all four tires should be of the same make, model, and size
3. Check air pressure in all four tires and set to specifications.
4. Check all four wheels for excessive brake drag. This could indicate sticky pistons or caliper slides.
5. Inspect all hydraulic lines for leaks and make needed repairs.
6. Inspect wheel bearings for excessive play and make needed repairs.
7. Top off brake fluid level if necessary.
8. Perform ABS and VDC sequence control procedures and compare your results to specifications in service manual.

Brake Systems

Access Trouble Codes

Trouble codes can be accessed with your NSM or by using the diagnostic connector located under the dash to the right of the steering wheel.

NOTE: THE NEW SELECT MONITOR IS THE PREFERRED METHOD FOR ACCESSING TROUBLE CODES AND INITIATING OTHER SERVICE PROCEDURES. MORE INFORMATION ON USING THE DIAGNOSTIC CONNECTOR CAN BE FOUND IN THE BRAKES SECTION OF THE SERVICE MANUAL.

If codes are stored, trouble shoot according to the diagnostic charts in the service manual. Remember that freeze frame information will be stored for the first trouble code the ABSCM detected. Freeze frame information can help reproduce the driving conditions under which the fault was detected. This can also be used to verify that a repair has been successfully completed.

Perform the inspection mode.

Verify that no additional trouble codes have been stored.

Sequence Control

On Subaru vehicles equipped with VDC, there is a procedure called sequence control that can be performed. Sequence control has two basic functions. The first is to allow the technician to check the mechanical condition of the pump and solenoids inside the ABS/VDC hydraulic control unit. The second function is to help purge air from ABS/VDC hydraulic control unit during a brake bleeding procedure.

There are two sequence control procedures that can be used on VDC equipped vehicles. The first procedure allows you to check the ABS side of the system while the second procedure allows you to check the VDC side of the system. Both sequence control procedures can be accomplished with the NSM.

Below you will find specs for a *2001 Outback Wagon* as an example:

ABS Sequence Control

	FRONT WHEEL	REAR WHEEL
Initial value	3,432 kPa (35 kg/cm ² , 498 psi)	3,432 kPa (35 kg/cm ² , 498 psi)
When decompressed	490 kPa (5 kg/cm ² , 71 psi) or less	490 kPa (5 kg/cm ² , 71 psi) or less
When compressed	3,432 kPa (35 kg/cm ² , 498 psi) or more	3,432 kPa (35 kg/cm ² , 498 psi) or more

VDC Sequence Control

	FRONT WHEEL	REAR WHEEL
When compressed	2,942 kPa (30 kg/cm ² , 427 psi) or more	1,961 kPa (20 kg/cm ² , 284 psi) or more
When decompressed	490 kPa (5 kg/cm ² , 71 psi) or less	490 kPa (5 kg/cm ² , 71 psi) or less

Service Bulletins

No.	Date	Title	Remarks
06-23-87	11/23/87	Subaru XT 1988 Service Manual Corrections	
06-24-91	08/15/91	Secondary Side Bleeding of A.B.S. Hydraulic Control Unit	
06-25-92	09/08/92	Brake Vibration Diagnosis and Repair	
06-23-93	01/12/93	Disc Brake Servicing	
06-27-93 18-21-93	10/29/93	Service Procedures for Codes 1-4, Section 4-4	Revised diagnostic trouble chart
06-28-96	06/11/96	A.B.S. Relay Sticking	
06-29-00	05/10/00	Low Brake Pedal Perception	

501 Module Service Help-Line Updates

Date Subject

07/95	Reading ABS Codes on early Subaru Legacy Models
08/95	Subaru Legacy-ABS light on
09/95	Brake fluid basics
09/95	ABS and Select Monitor usage
10/95	ABS/TCS equipped Legacy vehicles
11/95	1995/1996 Subaru Legacy with ABS
11/95	1996 Subaru Legacy equipped with ABS/5.3 system
12/95	ABS-2E control units and ABS code 23
12/95	Vehicle not complying with federal and state regulations
12/95	Intermittent wheel sensor codes in early Legacy ABS systems (non ABS-2E)
02/96	Brake noise...What is normal
06/96	5.3 ABS system service manual
08/96	ABS 5.3i ABS warning light operation
02/97	New 5.3i type ABS system
03/97	5.3i ABS system information update
04/97	Identifying ABS systems
10/97	ABS 5.3i ABS warning light operation
01/98	ABS/TCS code 57
05/98	Use of non-approved brake additives
02/99	1999 Forester ABS
03/99	Brake judder and noise; all models
06/01	2002MY Impreza brake rotor "SCORING"

