

# DIAGNOSTICS PROCEDURE WITHOUT SUBARU SELECT MONITOR

ABS (DIAGNOSTICS)

## 12. Diagnostics Procedure without Subaru Select Monitor

### A: ABS WARNING LIGHT DOES NOT COME ON

#### DIAGNOSIS:

- ABS warning light circuit is open or shorted.

#### TROUBLE SYMPTOM:

- When the ignition switch is turned to ON (engine OFF), ABS warning light does not come on.

#### WIRING DIAGRAM:

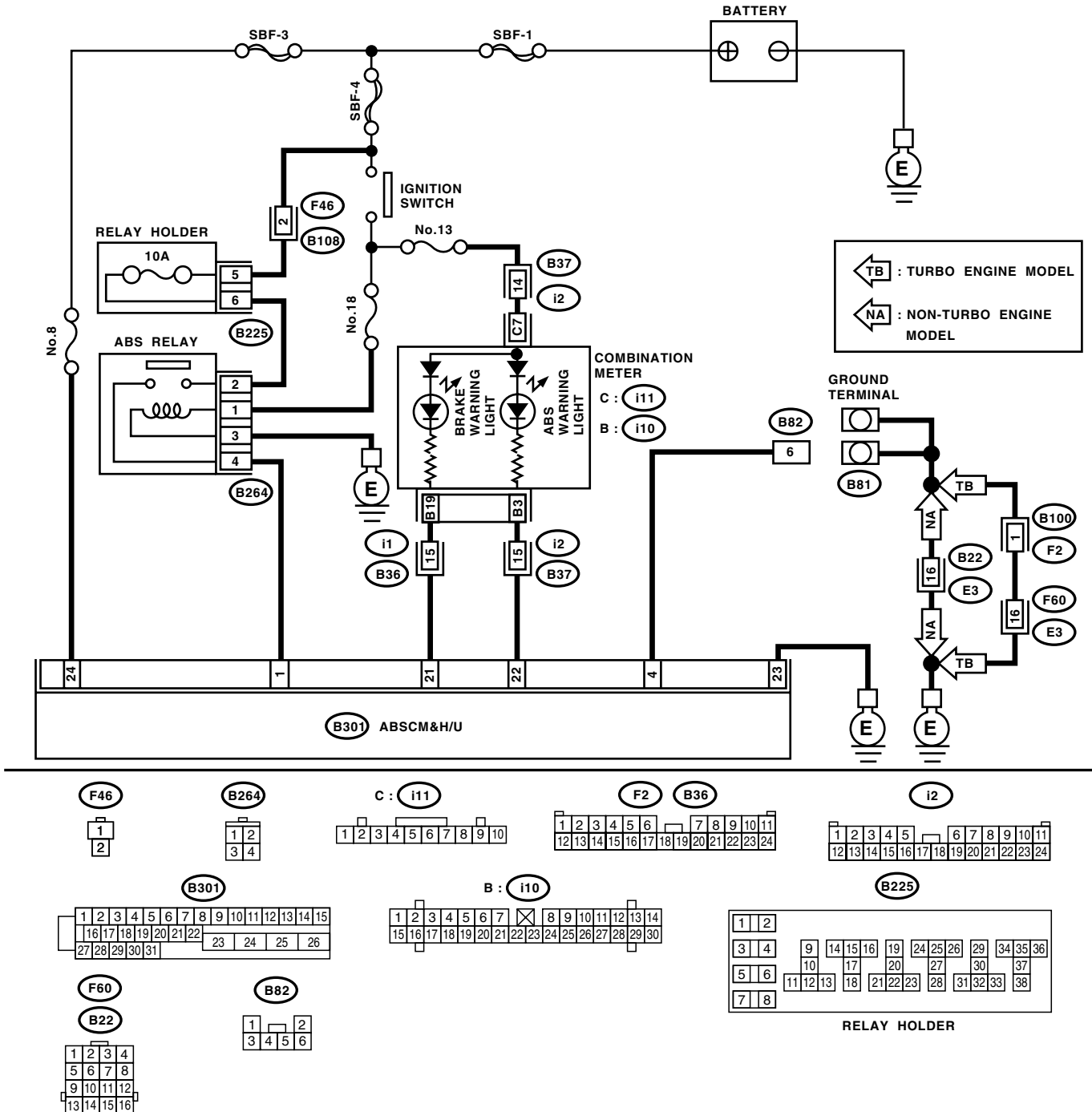

ABS00347

# DIAGNOSTICS PROCEDURE WITHOUT SUBARU SELECT MONITOR

ABS (DIAGNOSTICS)

Step	Check	Yes	No
<b>1 CHECK IF OTHER WARNING LIGHTS TURN ON.</b> Turn the ignition switch to ON (engine OFF).	Are other warning lights turned on?	Go to step 2.	Repair the combination meter. <Ref. to IDI-10, Combination Meter Assembly.>
<b>2 CHECK ABS AND BRAKE WARNING LIGHT BULB.</b> 1) Turn the ignition switch to OFF. 2) Remove the combination meter. 3) Remove the ABS warning light and brake warning light.	Is the ABS warning light bulb open?	Replace the ABS and brake warning light bulb. <Ref. to IDI-10, Combination Meter Assembly.>	Go to step 3.
<b>3 CHECK BATTERY SHORT OF ABS HARNESS.</b> 1) Disconnect the connector (i2) from connector (B37). 2) Measure the voltage between connector (i2) and chassis ground. <i>Connector &amp; terminal</i> <i>(i2) No. 15 (+) — Chassis ground (-):</i>	Is the voltage less than 3 V?	Go to step 4.	Repair battery short in the warning light harness.
<b>4 CHECK BATTERY SHORT OF ABS AND BRAKE WARNING LIGHT HARNESS.</b> 1) Turn the ignition switch to ON. 2) Measure the voltage between connector (i2) and chassis ground. <i>Connector &amp; terminal</i> <i>(i2) No. 15 (+) — Chassis ground (-):</i>	Is the voltage less than 3 V?	Go to step 5.	Repair battery short in the warning light harness.
<b>5 CHECK WIRING HARNESS.</b> 1) Turn the ignition switch to OFF. 2) Install the combination meter. 3) Turn the ignition switch to ON. 4) Measure the voltage between connector (i2) and chassis ground. <i>Connector &amp; terminal</i> <i>(i2) No. 15 (+) — Chassis ground (-):</i>	Is the voltage 10 — 15 V?	Go to step 6.	Repair open circuit in the wiring harness.
<b>6 CHECK BATTERY SHORT OF ABS AND BRAKE WARNING LIGHT HARNESS.</b> 1) Turn the ignition switch to OFF. 2) Measure the voltage between connector (B37) and chassis ground. <i>Connector &amp; terminal</i> <i>(B37) No. 15 (+) — Chassis ground (-):</i>	Is the voltage less than 3 V?	Go to step 7.	Repair battery short in the wiring harness.
<b>7 CHECK BATTERY SHORT OF ABS AND BRAKE WARNING LIGHT HARNESS.</b> 1) Turn the ignition switch to ON. 2) Measure the voltage between connector (B37) and chassis ground. <i>Connector &amp; terminal</i> <i>(B37) No. 15 (+) — Chassis ground (-):</i>	Is the voltage less than 3 V?	Go to step 8.	Repair battery short in the wiring harness.
<b>8 CHECK GROUND CIRCUIT OF ABSCM&amp;H/U.</b> 1) Turn the ignition switch to OFF. 2) Disconnect the connector from ABSCM&H/U. 3) Measure the resistance between ABSCM&H/U and chassis ground. <i>Connector &amp; terminal</i> <i>(B301) No. 23 — Chassis ground:</i>	Is the resistance less than 0.5 $\Omega$ ?	Go to step 9.	Repair open circuit in the ABSCM&H/U ground harness.

# DIAGNOSTICS PROCEDURE WITHOUT SUBARU SELECT MONITOR

## ABS (DIAGNOSTICS)

Step	Check	Yes	No
<b>9</b> <b>CHECK WIRING HARNESS.</b> Measure the resistance between connector (B37) and chassis ground. <b>Connector &amp; terminal</b> <b>(B37) No. 15 — Chassis ground:</b>	Is the resistance less than 0.5 $\Omega$ ?	Go to step <b>10</b> .	Repair open circuit in the harness/connector.
<b>10</b> <b>CHECK POOR CONTACT IN CONNECTORS.</b> Turn the ignition switch to OFF.	Is there poor contact in connectors between combination meter and ABSCM&H/U?	Repair the connector.	Replace the ABSCM&H/U. <Ref. to ABS-6, ABS Control Module and Hydraulic Control Unit (ABSCM&H/U).>

# DIAGNOSTICS PROCEDURE WITHOUT SUBARU SELECT MONITOR

ABS (DIAGNOSTICS)

## B: ABS WARNING LIGHT DOES NOT GO OFF

### DIAGNOSIS:

- ABS warning light circuit is open or shorted.

### TROUBLE SYMPTOM:

- When starting the engine and while ABS warning light is kept ON.

### WIRING DIAGRAM:

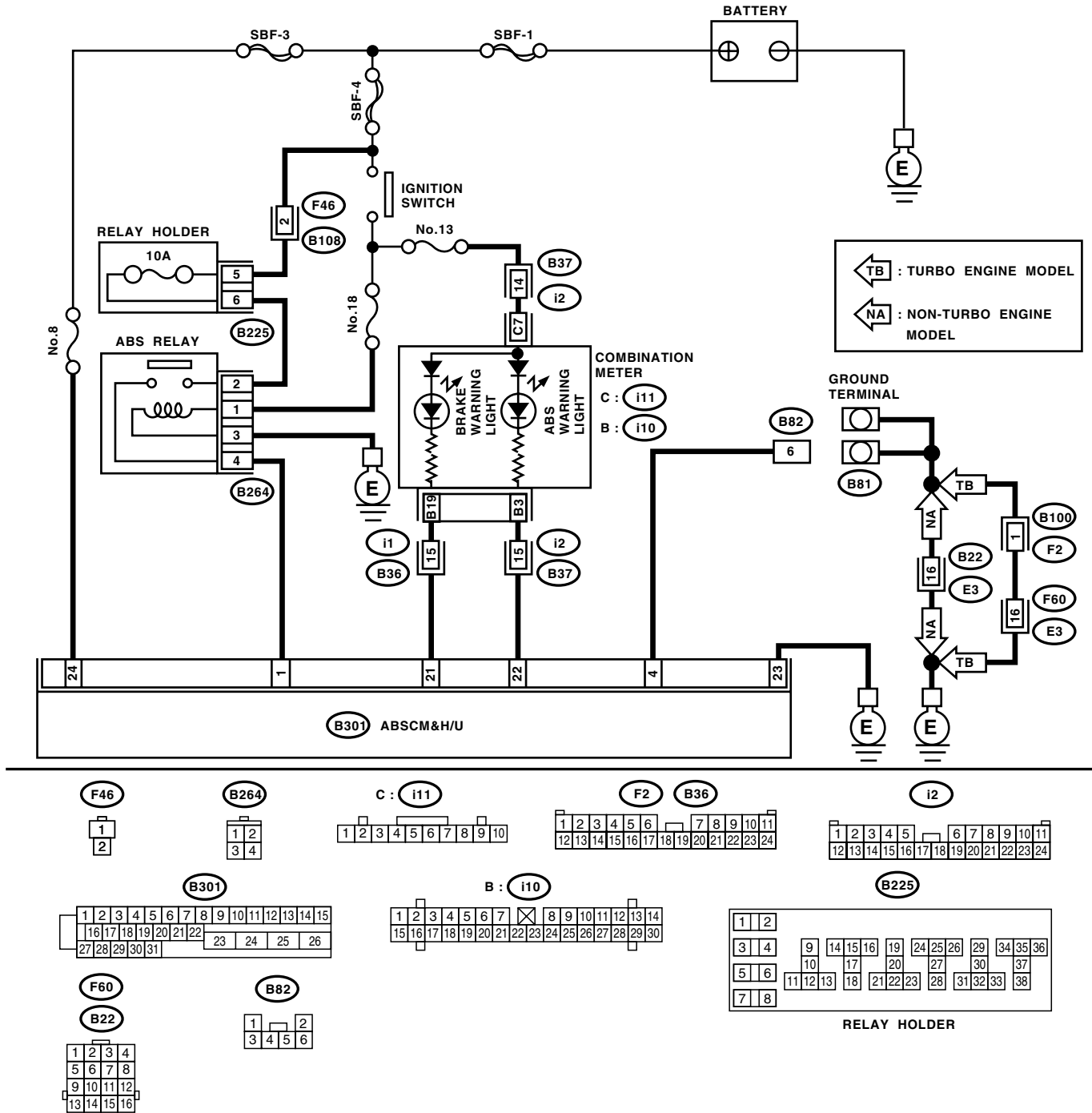

ABS00347

# DIAGNOSTICS PROCEDURE WITHOUT SUBARU SELECT MONITOR

## ABS (DIAGNOSTICS)

Step	Check	Yes	No
<b>1 CHECK INSTALLATION OF ABSCM&amp;H/U CONNECTOR.</b> Turn the ignition switch to OFF.	Is the ABSCM&H/U connector inserted into ABSCM until the clamp locks onto it?	Go to step 2.	Insert the ABSCM&H/U connector into ABSCM&H/U until the clamp locks onto it.
<b>2 CHECK GROUND TERMINAL.</b> Measure the resistance between Ground terminals (B81) and chassis ground. <i>Terminals</i> <i>Ground terminal (A) — Chassis ground:</i> <i>Ground terminal (B) — Chassis ground:</i>	Is the resistance less than 0.5 $\Omega$ ?	Go to step 3.	Repair the open circuit in Ground terminal harness.
<b>3 CHECK DIAGNOSIS LINE.</b> 1)Connect the Ground terminal (B81) to diagnosis connector (B82) No. 6. 2)Disconnect the connector from ABSCM&H/U. 3)Measure the resistance between ABSCM&H/U connector and chassis ground. <i>Connector &amp; terminal</i> <i>(B301) No. 4 — Chassis ground:</i>	Is the resistance less than 0.5 $\Omega$ ?	Go to step 4.	Repair the open circuit in harness connector between ABSCM&H/U and diagnosis connector.
<b>4 CHECK GENERATOR.</b> 1)Start the engine. 2)Idle the engine. 3)Measure the voltage between generator and chassis ground. <i>Terminals</i> <i>Generator B terminal (+) — Chassis ground (-):</i>	Is the voltage 10 — 15 V?	Go to step 5.	Repair the generator. <Ref. to SC(H4SO)-14, Generator.>
<b>5 CHECK BATTERY TERMINAL.</b> Turn the ignition switch to OFF.	Is there poor contact at battery terminal?	Repair or tighten the battery terminal.	Go to step 6.
<b>6 CHECK POWER SUPPLY OF ABSCM.</b> 1)Start the engine. 2)Idle the engine. 3)Measure the voltage between ABSCM&H/U connector and chassis ground. <i>Connector &amp; terminal</i> <i>(B301) No. 1 (+) — Chassis ground (-):</i>	Is the voltage 10 — 15 V?	Go to step 7.	Repair the ABSCM&H/U power supply circuit.
<b>7 CHECK WIRING HARNESS.</b> 1)Disconnect the connector (i2) from connector (B37). 2)Turn the ignition switch to ON.	Does the ABS warning light turn on?	Repair the front or body wiring harness.	Go to step 8.
<b>8 CHECK PROJECTION AT ABSCM&amp;H/U.</b> 1)Turn the ignition switch to OFF. 2)Check for damage at the ABSCM&H/U terminal. NOTE: For detail of connector switch, refer to following. <Ref. to ABS-12, ELECTRICAL SPECIFICATION, Control Module I/O Signal.>	Is there any damage on projection which switches connector switch?	Replace the ABSCM&H/U. <Ref. to ABS-6, ABS Control Module and Hydraulic Control Unit (ABSCM&H/U).>	Go to step 9.
<b>9 CHECK ABSCM&amp;H/U.</b> Measure the resistance between ABSCM&H/U terminals. <i>Terminals</i> <i>No. 22 — No. 23:</i>	Is the resistance more than 1 M $\Omega$ ?	Go to step 10.	Replace the ABSCM&H/U. <Ref. to ABS-6, ABS Control Module and Hydraulic Control Unit (ABSCM&H/U).>

# DIAGNOSTICS PROCEDURE WITHOUT SUBARU SELECT MONITOR

ABS (DIAGNOSTICS)

Step	Check	Yes	No
<b>10 CHECK WIRING HARNESS.</b> Measure the resistance between connector (B37) and chassis ground. <i><b>Connector &amp; terminal</b></i> <i><b>(B37) No. 15 — Chassis ground:</b></i>	Is the resistance less than 0.5 $\Omega$ ?	Go to step <b>11</b> .	Repair the harness.
<b>11 CHECK WIRING HARNESS.</b> 1)Connect the connector to ABSCM&H/U. 2)Measure the resistance between connector (B37) and chassis ground. <i><b>Connector &amp; terminal</b></i> <i><b>(B37) No. 15 — Chassis ground:</b></i>	Is the resistance more than 1 M $\Omega$ ?	Go to step <b>12</b> .	Repair the harness.
<b>12 CHECK POOR CONTACT IN ABSCM&amp;H/U CONNECTOR.</b>	Is there poor contact in ABSCM&H/U connector?	Repair the connector.	Replace the ABSCM&H/U. <Ref. to ABS-6, ABS Control Module and Hydraulic Control Unit (ABSCM&H/U).>

# DIAGNOSTICS PROCEDURE WITHOUT SUBARU SELECT MONITOR

ABS (DIAGNOSTICS)

## C: BRAKE WARNING LIGHT DO NOT GO OFF

### DIAGNOSIS:

- Brake warning light circuit is shorted.
- Faulty sensor/connector

### TROUBLE SYMPTOM:

- After starting the engine, brake warning light is kept ON, even if the parking brake lever has been released.

### WIRING DIAGRAM:

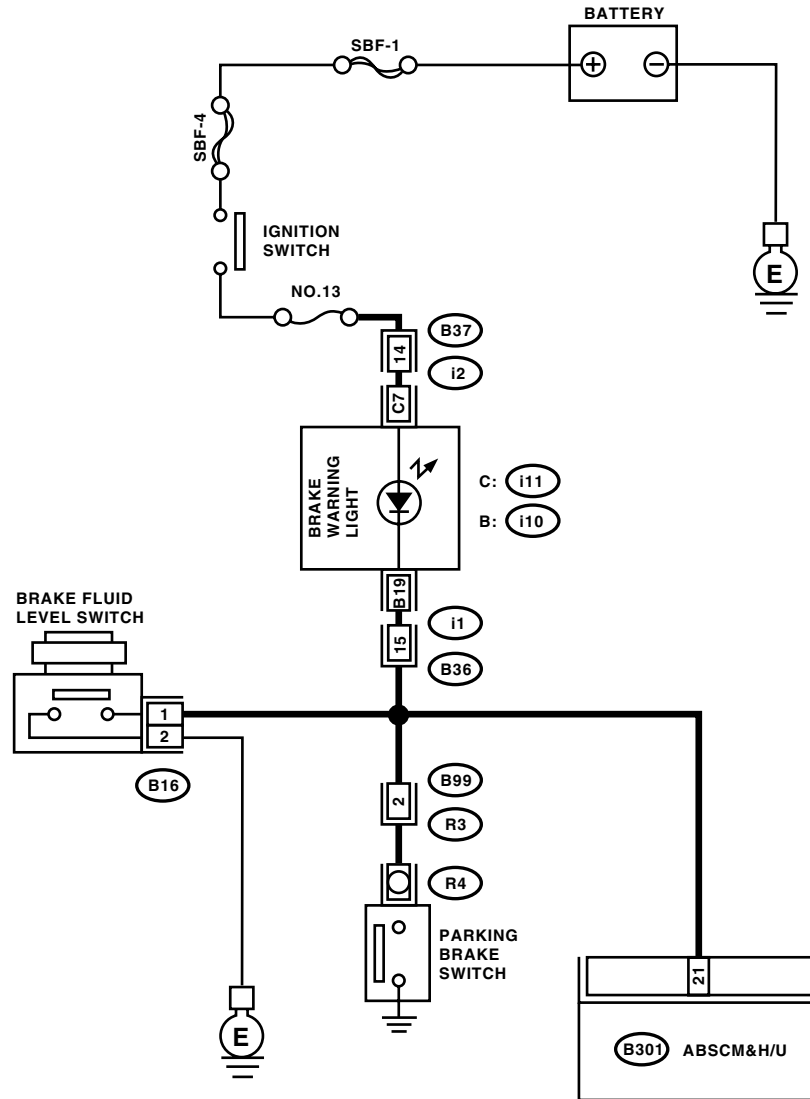

B16



i1

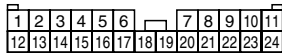

B301

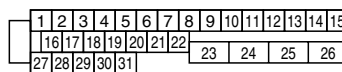

B: i10

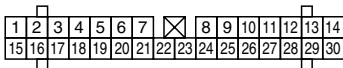

C: i11

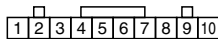

B99 i2

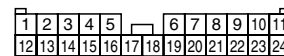

ABS00350

# DIAGNOSTICS PROCEDURE WITHOUT SUBARU SELECT MONITOR

ABS (DIAGNOSTICS)

Step	Check	Yes	No
<b>1 CHECK BRAKE FLUID AMOUNT.</b> Check the amount of brake fluid in reservoir tank of master cylinder.	Is the brake fluid amount between "MAX" line and "MIN" line?	Go to step 2.	Fill the brake fluid to specified amount.
<b>2 CHECK BRAKE FLUID LEVEL SWITCH.</b> 1)Disconnect the level switch connector (B16) from master cylinder. 2)Measure the resistance of master cylinder terminals. <i>Terminals</i> <i>No. 1 — No. 2:</i>	Is the resistance more than 1 MΩ?	Go to step 3.	Replace the master cylinder.
<b>3 CHECK PARKING BRAKE SWITCH.</b> 1)Disconnect the connector (R4) from parking brake switch. 2)Release the parking brake switch. 3)Measure the resistance between parking brake switch terminal and chassis ground.	Is the resistance more than 1 MΩ?	Go to step 4.	Replace the parking brake switch.
<b>4 CHECK GROUND SHORT OF HARNESS.</b> 1)Disconnect the connector from ABSCM & H/U. 2)Disconnect the connector (i1) from combination meter. 3)Turn the ignition switch to ON.	Does the brake warning light go off?	Go to step 5.	Repair the harness.
<b>5 CHECK POOR CONTACT IN ABSCM &amp; H/U.</b>	Is there poor contact in ABSCM & H/U connector?	Repair the connector.	Replace the ABSCM&H/U. <Ref. to ABS-6, ABS Control Module and Hydraulic Control Unit (ABSCM&H/U).>



# DIAGNOSTICS PROCEDURE WITHOUT SUBARU SELECT MONITOR

## ABS (DIAGNOSTICS)

### D: DTC DOES NOT APPEAR

#### DIAGNOSIS:

- Diagnosis circuit is open.

#### TROUBLE SYMPTOM:

- The ABS warning light turns on or off normally but the start code cannot be read out in diagnostic mode.

#### WIRING DIAGRAM:

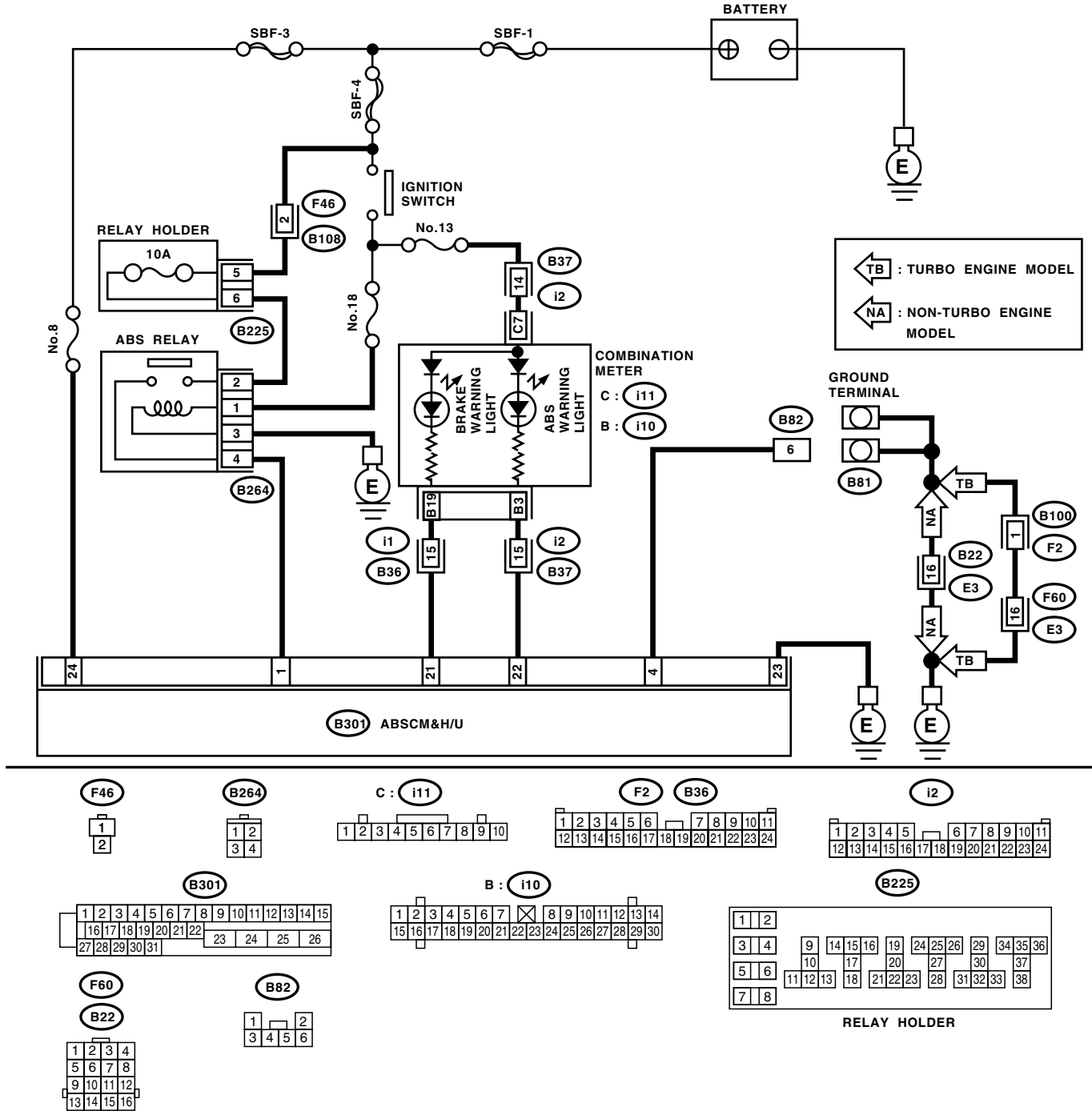

ABS00347

# DIAGNOSTICS PROCEDURE WITHOUT SUBARU SELECT MONITOR

ABS (DIAGNOSTICS)

Step	Check	Yes	No
<b>1 CHECK GROUND TERMINAL.</b> 1) Turn the ignition switch to OFF. 2) Measure the resistance between Ground terminals (B81) and chassis ground. <i>Terminals</i> <i>Ground terminal (A) — Chassis ground:</i> <i>Ground terminal (B) — Chassis ground:</i>	Is the resistance less than 0.5 $\Omega$ ?	Go to step 2.	Repair the Ground terminal harness.
<b>2 CHECK DIAGNOSIS LINE.</b> 1) Connect the Ground terminal (B81) to diagnosis connector (B82) No. 6. 2) Disconnect the connector from ABSCM&H/U. 3) Measure the resistance between ABSCM&H/U connector and chassis ground. <i>Connector &amp; terminal</i> <i>(B301) No. 4 — Chassis ground:</i>	Is the resistance less than 0.5 $\Omega$ ?	Go to step 3.	Repair the harness connector between ABSCM&H/U and diagnosis connector.
<b>3 CHECK POOR CONTACT IN ABSCM&amp;H/U CONNECTOR.</b>	Is there poor contact in ABSCM&H/U connector?	Repair the connector.	Replace the ABSCM&H/U. <Ref. to ABS-6, ABS Control Module and Hydraulic Control Unit (ABSCM&H/U).>

## E: DTC 21

### — ABNORMAL ABS WHEEL SPEED SENSOR (OPEN CIRCUIT OR INPUT VOLTAGE TOO HIGH) (FRONT RH) —

**NOTE:**

For the diagnostic procedure, refer to DTC 27. <Ref. to ABS-38, DTC 27 — ABNORMAL ABS WHEEL SPEED SENSOR (OPEN CIRCUIT OR INPUT VOLTAGE TOO HIGH) (REAR LH) —, Diagnostics Procedure without Subaru Select Monitor.>

## F: DTC 23

### — ABNORMAL ABS WHEEL SPEED SENSOR (OPEN CIRCUIT OR INPUT VOLTAGE TOO HIGH) (FRONT LH) —

**NOTE:**

For the diagnostic procedure, refer to DTC 27. <Ref. to ABS-38, DTC 27 — ABNORMAL ABS WHEEL SPEED SENSOR (OPEN CIRCUIT OR INPUT VOLTAGE TOO HIGH) (REAR LH) —, Diagnostics Procedure without Subaru Select Monitor.>

## G: DTC 25

### — ABNORMAL ABS WHEEL SPEED SENSOR (OPEN CIRCUIT OR INPUT VOLTAGE TOO HIGH) (REAR RH) —

**NOTE:**

For the diagnostic procedure, refer to DTC 27. <Ref. to ABS-38, DTC 27 — ABNORMAL ABS WHEEL SPEED SENSOR (OPEN CIRCUIT OR INPUT VOLTAGE TOO HIGH) (REAR LH) —, Diagnostics Procedure without Subaru Select Monitor.>

# DIAGNOSTICS PROCEDURE WITHOUT SUBARU SELECT MONITOR

ABS (DIAGNOSTICS)

## H: DTC 27

### — ABNORMAL ABS WHEEL SPEED SENSOR (OPEN CIRCUIT OR INPUT VOLTAGE TOO HIGH) (REAR LH) —

#### DIAGNOSIS:

- Faulty ABS wheel speed sensor (Broken wire, input voltage too high)
- Faulty harness connector

#### TROUBLE SYMPTOM:

- ABS does not operate.

#### WIRING DIAGRAM:

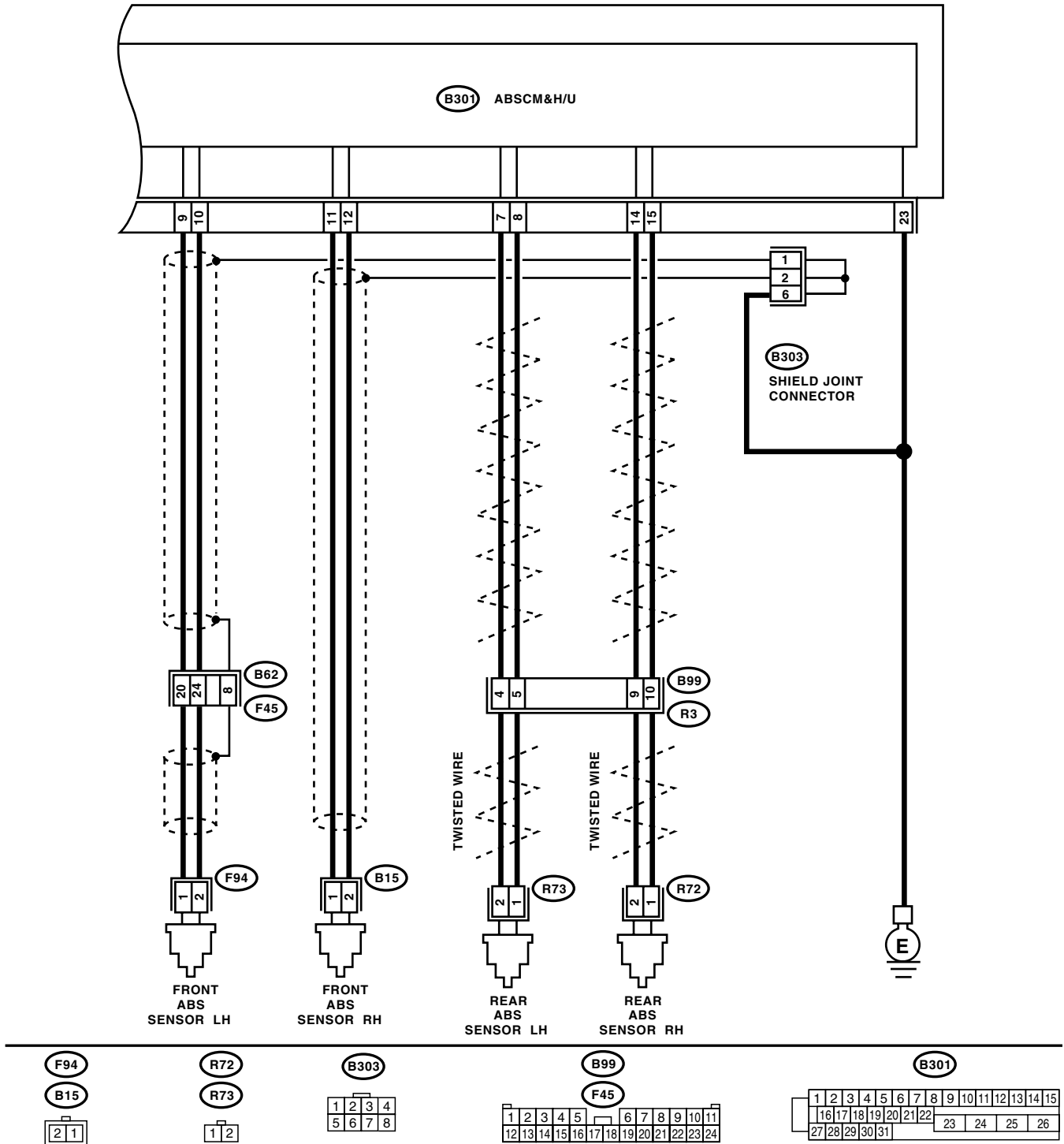

ABS00353

# DIAGNOSTICS PROCEDURE WITHOUT SUBARU SELECT MONITOR

ABS (DIAGNOSTICS)

Step	Check	Yes	No
<p><b>1</b></p> <p><b>CHECK ABS WHEEL SPEED SENSOR.</b>                      1) Turn the ignition switch to OFF.                      2) Disconnect the connector from ABS wheel speed sensor.                      3) Measure the resistance of ABS wheel speed sensor connector terminals while shaking the harness lightly.</p> <p><b>Terminals</b>  <b>Front RH No. 1 — No. 2:</b>  <b>Front LH No. 1 — No. 2:</b>  <b>Rear RH No. 1 — No. 2:</b>  <b>Rear LH No. 1 — No. 2:</b></p>	<p>Is the resistance as following value?                      Front: 1 — 1.5 kΩ                      Rear: 1.025 — 1.265 kΩ</p>	Go to step 2.	<p>Replace the ABS wheel speed sensor. Front: &lt;Ref. to ABS-12, Front ABS Wheel Speed Sensor.&gt; Rear: &lt;Ref. to ABS-15, Rear ABS Wheel Speed Sensor.&gt;</p>
<p><b>2</b></p> <p><b>CHECK BATTERY SHORT OF ABS WHEEL SPEED SENSOR.</b>                      1) Disconnect the connector from ABSCM&amp;H/U.                      2) Measure the voltage between ABS wheel speed sensor and chassis ground.</p> <p><b>Terminals</b>  <b>Front RH No. 1 (+) — Chassis ground (-):</b>  <b>Front LH No. 1 (+) — Chassis ground (-):</b>  <b>Rear RH No. 1 (+) — Chassis ground (-):</b>  <b>Rear LH No. 1 (+) — Chassis ground (-):</b></p>	Is the voltage less than 1 V?	Go to step 3.	<p>Replace the ABS wheel speed sensor. Front: &lt;Ref. to ABS-12, Front ABS Wheel Speed Sensor.&gt; Rear: &lt;Ref. to ABS-15, Rear ABS Wheel Speed Sensor.&gt;</p>
<p><b>3</b></p> <p><b>CHECK BATTERY SHORT OF ABS WHEEL SPEED SENSOR.</b>                      1) Turn the ignition switch to ON.                      2) Measure the voltage between ABS wheel speed sensor and chassis ground.</p> <p><b>Terminals</b>  <b>Front RH No. 1 (+) — Chassis ground (-):</b>  <b>Front LH No. 1 (+) — Chassis ground (-):</b>  <b>Rear RH No. 1 (+) — Chassis ground (-):</b>  <b>Rear LH No. 1 (+) — Chassis ground (-):</b></p>	Is the voltage less than 1 V?	Go to step 4.	<p>Replace the ABS wheel speed sensor. Front: &lt;Ref. to ABS-12, Front ABS Wheel Speed Sensor.&gt; Rear: &lt;Ref. to ABS-15, Rear ABS Wheel Speed Sensor.&gt;</p>
<p><b>4</b></p> <p><b>CHECK HARNESS/CONNECTOR BETWEEN ABSCM&amp;H/U AND ABS WHEEL SPEED SENSOR.</b>                      1) Turn the ignition switch to OFF.                      2) Connect the connector to ABS wheel speed sensor.                      3) Measure the resistance between ABSCM&amp;H/U connector terminals.</p> <p><b>Connector &amp; terminal</b>  <b>DTC 21</b>  <b>(B301) No. 11 — No. 12:</b>  <b>DTC 23</b>  <b>(B301) No. 9 — No. 10:</b>  <b>DTC 25</b>  <b>(B301) No. 14 — No. 15:</b>  <b>DTC 27</b>  <b>(B301) No. 7 — No. 8:</b></p>	<p>Is the resistance as following value?                      Front: 1 — 1.5 kΩ                      Rear: 1.025 — 1.265 kΩ</p>	Go to step 5.	<p>Repair the harness/connector between ABSCM&amp;H/U and ABS wheel speed sensor.</p>

# DIAGNOSTICS PROCEDURE WITHOUT SUBARU SELECT MONITOR

## ABS (DIAGNOSTICS)

Step	Check	Yes	No
<b>5 CHECK BATTERY SHORT OF HARNESS.</b> Measure the voltage between ABSCM&H/U connector and chassis ground. <i>Connector &amp; terminal</i> <b>DTC 21</b> (B301) No. 11 (+) — Chassis ground (-): <b>DTC 23</b> (B301) No. 9 (+) — Chassis ground (-): <b>DTC 25</b> (B301) No. 14 (+) — Chassis ground (-): <b>DTC 27</b> (B301) No. 7 (+) — Chassis ground (-):	Is the voltage less than 1 V?	Go to step 6.	Repair the harness between ABSCM&H/U and ABS wheel speed sensor.
<b>6 CHECK BATTERY SHORT OF HARNESS.</b> 1) Turn the ignition switch to ON. 2) Measure the voltage between ABSCM&H/U connector and chassis ground. <i>Connector &amp; terminal</i> <b>DTC 21</b> (B301) No. 11 (+) — Chassis ground (-): <b>DTC 23</b> (B301) No. 9 (+) — Chassis ground (-): <b>DTC 25</b> (B301) No. 14 (+) — Chassis ground (-): <b>DTC 27</b> (B301) No. 7 (+) — Chassis ground (-):	Is the voltage less than 1 V?	Go to step 7.	Repair the harness between ABSCM&H/U and ABS wheel speed sensor.
<b>7 CHECK INSTALLATION OF ABS WHEEL SPEED SENSOR.</b> Turn the ignition switch to OFF.	Are the ABS wheel speed sensor installation bolts tightened 33 N·m (3.3 kgf·m, 24 ft·lb)?	Go to step 8.	Tighten the ABS wheel speed sensor installation bolts securely.
<b>8 CHECK ABS WHEEL SPEED SENSOR GAP.</b> Measure the tone wheel to ABS wheel speed sensor piece gap over entire perimeter of the wheel.	Is the gap as following value? Front wheel: 0.3 — 0.8 mm (0.012 — 0.031 in) Rear wheel 0.7 — 1.2 mm (0.028 — 0.047 in)	Go to step 9.	Adjust the gap. NOTE: Adjust the gap using spacers (Part No. 26755AA000). If the spacers cannot correct gap, replace worn sensor or worn tone wheel.
<b>9 CHECK TONE WHEEL RUNOUT.</b> Measure the tone wheel runout.	Is the runout less than 0.05 mm (0.0020 in)?	Go to step 10.	Replace the tone wheel. Front: <Ref. to ABS-18, Front Tone Wheel.> Rear: <Ref. to ABS-19, Rear Tone Wheel.>

# DIAGNOSTICS PROCEDURE WITHOUT SUBARU SELECT MONITOR

ABS (DIAGNOSTICS)

Step	Check	Yes	No
<b>10 CHECK GROUND SHORT OF ABS WHEEL SPEED SENSOR.</b> 1) Turn the ignition switch to ON. 2) Measure the resistance between ABS wheel speed sensor and chassis ground. <b>Terminals</b> <i>Front RH No. 1 — Chassis ground:</i> <i>Front LH No. 1 — Chassis ground:</i> <i>Rear RH No. 1 — Chassis ground:</i> <i>Rear LH No. 1 — Chassis ground:</i>	Is the resistance more than 1 M $\Omega$ ?	Go to step 11.	Replace the ABS wheel speed sensor and ABSCM&H/U. Front: <Ref. to ABS-12, Front ABS Wheel Speed Sensor.> Rear: <Ref. to ABS-15, Rear ABS Wheel Speed Sensor.> and <Ref. to ABS-6, ABS Control Module and Hydraulic Control Unit (ABSCM&H/U).>
<b>11 CHECK GROUND SHORT OF HARNESS.</b> 1) Turn the ignition switch to OFF. 2) Connect the connector to ABS wheel speed sensor. 3) Measure the resistance between ABSCM&H/U connector terminal and chassis ground. <b>Connector &amp; terminal</b> <b>DTC 21</b> <i>(B301) No. 11 — Chassis ground:</i> <b>DTC 23</b> <i>(B301) No. 11 — Chassis ground:</i> <b>DTC 25</b> <i>(B301) No. 14 — Chassis ground:</i> <b>DTC 27</b> <i>(B301) No. 7 — Chassis ground:</i>	Is the resistance more than 1 M $\Omega$ ?	Go to step 12.	Repair the harness between ABSCM&H/U and ABS wheel speed sensor. Replace the ABSCM&H/U. <Ref. to ABS-6, ABS Control Module and Hydraulic Control Unit (ABSCM&H/U).>
<b>12 CHECK POOR CONTACT IN CONNECTORS.</b>	Is there poor contact in connectors between ABSCM&H/U and ABS wheel speed sensor?	Repair the connector.	Go to step 13.
<b>13 CHECK ABSCM&amp;H/U.</b> 1) Connect all connectors. 2) Erase the memory. 3) Perform the inspection mode. 4) Read out the DTC.	Is the same DTC as in current diagnosis still being output?	Replace the ABSCM&H/U. <Ref. to ABS-6, ABS Control Module and Hydraulic Control Unit (ABSCM&H/U).>	Go to step 14.
<b>14 CHECK ANY OTHER DTC APPEARANCE.</b>	Are other DTCs being output?	Proceed with the diagnosis corresponding to the DTC.	A temporary poor contact. NOTE: Check the harness and connectors between ABSCM&H/U and ABS wheel speed sensor.

# DIAGNOSTICS PROCEDURE WITHOUT SUBARU SELECT MONITOR

ABS (DIAGNOSTICS)

---

## **I: DTC 22**

**— ABNORMAL ABS WHEEL SPEED SENSOR (ABNORMAL ABS WHEEL SPEED SENSOR SIGNAL) (FRONT RH) —**

NOTE:

For the diagnostic procedure, refer to DTC 28. <Ref. to ABS-43, DTC 28 — ABNORMAL ABS WHEEL SPEED SENSOR (ABNORMAL ABS WHEEL SPEED SENSOR SIGNAL) (REAR LH) —, Diagnostics Procedure without Subaru Select Monitor.>

## **J: DTC 24**

**— ABNORMAL ABS WHEEL SPEED SENSOR (ABNORMAL ABS WHEEL SPEED SENSOR SIGNAL) (FRONT LH) —**

NOTE:

For the diagnostic procedure, refer to DTC 28. <Ref. to ABS-43, DTC 28 — ABNORMAL ABS WHEEL SPEED SENSOR (ABNORMAL ABS WHEEL SPEED SENSOR SIGNAL) (REAR LH) —, Diagnostics Procedure without Subaru Select Monitor.>

## **K: DTC 26**

**— ABNORMAL ABS WHEEL SPEED SENSOR (ABNORMAL ABS WHEEL SPEED SENSOR SIGNAL) (REAR RH) —**

NOTE:

For the diagnostic procedure, refer to DTC 28. <Ref. to ABS-43, DTC 28 — ABNORMAL ABS WHEEL SPEED SENSOR (ABNORMAL ABS WHEEL SPEED SENSOR SIGNAL) (REAR LH) —, Diagnostics Procedure without Subaru Select Monitor.>

# DIAGNOSTICS PROCEDURE WITHOUT SUBARU SELECT MONITOR

ABS (DIAGNOSTICS)

## L: DTC 28

### — ABNORMAL ABS WHEEL SPEED SENSOR (ABNORMAL ABS WHEEL SPEED SENSOR SIGNAL) (REAR LH) —

#### DIAGNOSIS:

- Faulty ABS wheel speed sensor signal (noise, irregular signal, etc.)
- Faulty harness/connector

#### TROUBLE SYMPTOM:

- ABS does not operate.

#### WIRING DIAGRAM:

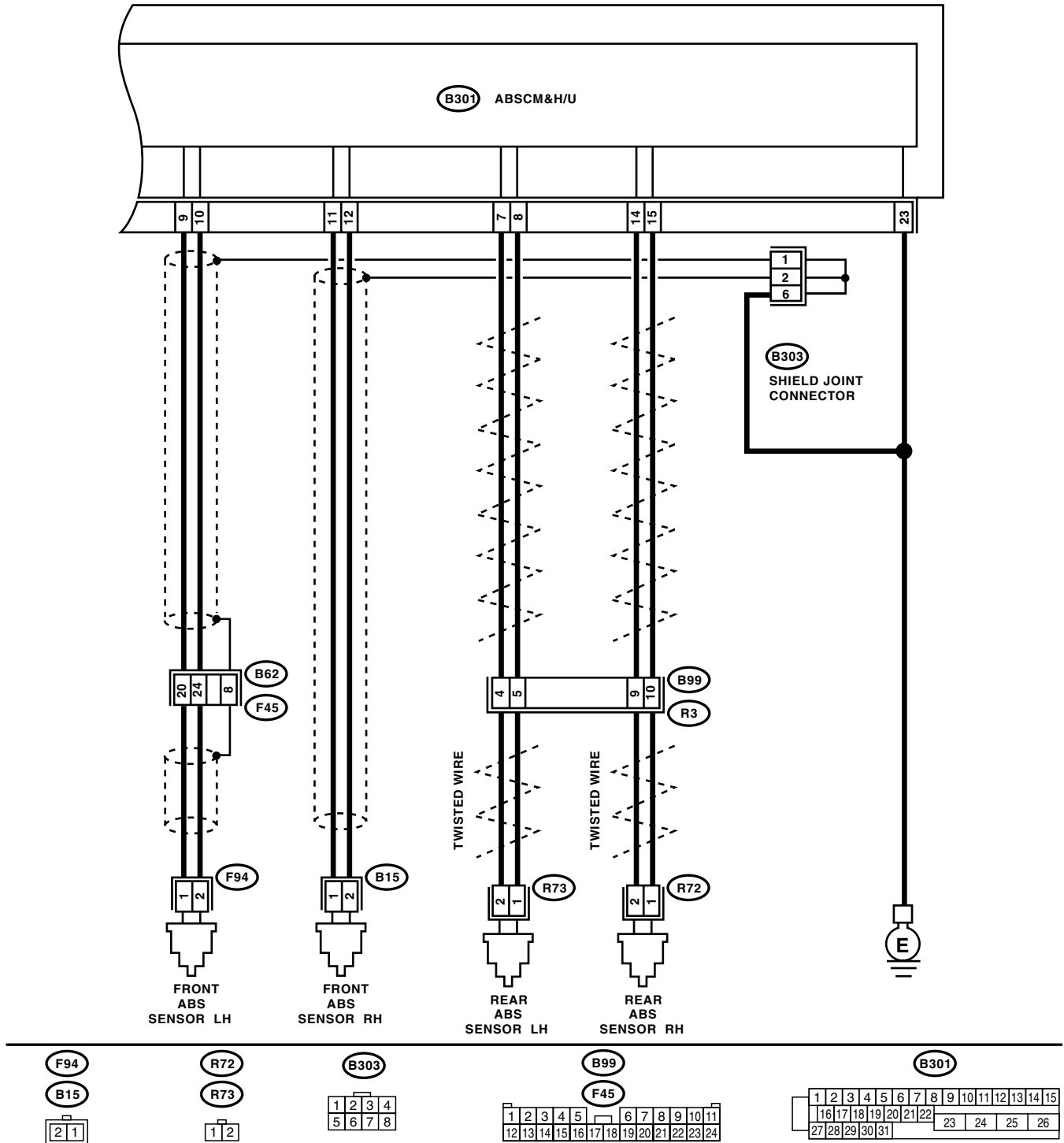

ABS00353



# DIAGNOSTICS PROCEDURE WITHOUT SUBARU SELECT MONITOR

## ABS (DIAGNOSTICS)

Step	Check	Yes	No
<b>1 CHECK INSTALLATION OF ABS WHEEL SPEED SENSOR.</b> Turn the ignition switch to OFF.	Are the ABS wheel speed sensor installation bolts tightened 33 N·m (3.3 kgf-m, 24 ft-lb)?	Go to step 2.	Tighten the ABS wheel speed sensor installation bolts securely.
<b>2 CHECK ABS WHEEL SPEED SENSOR GAP.</b> Measure the tone wheel to ABS wheel speed sensor piece gap over entire perimeter of the wheel.	Is the gap as following value? Front wheel: 0.3 — 0.8 mm (0.012 — 0.031 in) Rear wheel 0.7 — 1.2 mm (0.028 — 0.047 in)	Go to step 3.	Adjust the gap. NOTE: Adjust the gap using spacer (Part No. 26755AA000). If the spacer cannot correct gap, replace worn sensor or worn tone wheel.
<b>3 PREPARE OSCILLOSCOPE.</b>	Is an oscilloscope available?	Go to step 4.	Go to step 5.
<b>4 CHECK ABS WHEEL SPEED SENSOR SIGNAL.</b> 1) Raise all four wheels off ground. 2) Turn the ignition switch to OFF. 3) Connect the oscilloscope to the connector. 4) Turn the ignition switch to ON. 5) Rotate the wheels and measure voltage at specified frequency. <Ref. to ABS-15, WAVEFORM, Control Module I/O Signal.> NOTE: When this inspection is completed, the ABS control module sometimes stores DTC 29 or DTC 56. <b>Connector &amp; terminal</b> <b>DTC 22</b> (B15) No. 1 (+) — No. 2 (-): <b>DTC 24</b> (F45) No. 20 (+) — No. 24 (-): <b>DTC 26</b> (B99) No. 10 (+) — No. 9 (-): <b>DTC 28</b> (B99) No. 5 (+) — No. 4 (-):	Is an oscilloscope pattern smooth, as shown in the figure?	Go to step 8.	Go to step 7.
<b>5 CHECK CONTAMINATION OF ABS WHEEL SPEED SENSOR OR TONE WHEEL.</b> Remove the disc rotor or drum from hub in accordance with DTC.	Is the ABS wheel speed sensor piece or the tone wheel contaminated by dirt or other foreign matter?	Thoroughly remove dirt or other foreign matter.	Go to step 6.
<b>6 CHECK DAMAGE OF ABS WHEEL SPEED SENSOR OR TONE WHEEL.</b>	Are there broken or damaged in the ABS wheel speed sensor piece or the tone wheel?	Replace the ABS wheel speed sensor or tone wheel. Front: <Ref. to ABS-12, Front ABS Wheel Speed Sensor.> Rear: <Ref. to ABS-15, Rear ABS Wheel Speed Sensor.> and Front: <Ref. to ABS-18, Front Tone Wheel.> Rear: <Ref. to ABS-19, Rear Tone Wheel.>	Go to step 7.

# DIAGNOSTICS PROCEDURE WITHOUT SUBARU SELECT MONITOR

ABS (DIAGNOSTICS)

Step	Check	Yes	No	
7	<p><b>CHECK TONE WHEEL RUNOUT.</b> Measure the tone wheel runout.</p>	Is the runout less than 0.05 mm (0.0020 in)?	Go to step 8.	Replace the tone wheel. Front: <Ref. to ABS-18, Front Tone Wheel.> Rear: <Ref. to ABS-19, Rear Tone Wheel.>
8	<p><b>CHECK RESISTANCE OF ABS WHEEL SPEED SENSOR.</b> 1) Turn the ignition switch to OFF. 2) Disconnect the connector from ABS wheel speed sensor. 3) Measure the resistance between ABS wheel speed sensor connector terminals while shaking the harness lightly.</p> <p><b>Terminals</b> <b>Front RH No. 1 — No. 2:</b> <b>Front LH No. 1 — No. 2:</b> <b>Rear RH No. 1 — No. 2:</b> <b>Rear LH No. 1 — No. 2:</b></p>	Is the resistance as following value? Front: 1 — 1.5 kΩ Rear: 1.025 — 1.265 kΩ	Go to step 9.	Replace the ABS wheel speed sensor. Front: <Ref. to ABS-12, Front ABS Wheel Speed Sensor.> Rear: <Ref. to ABS-15, Rear ABS Wheel Speed Sensor.>
9	<p><b>CHECK GROUND SHORT OF ABS WHEEL SPEED SENSOR.</b> Measure the resistance between ABS wheel speed sensor and chassis ground.</p> <p><b>Terminals</b> <b>Front RH No. 1 — Chassis ground:</b> <b>Front LH No. 1 — Chassis ground:</b> <b>Rear RH No. 1 — Chassis ground:</b> <b>Rear LH No. 1 — Chassis ground:</b></p>	Is the resistance more than 1 MΩ?	Go to step 10.	Replace the ABS wheel speed sensor. Front: <Ref. to ABS-12, Front ABS Wheel Speed Sensor.> Rear: <Ref. to ABS-15, Rear ABS Wheel Speed Sensor.>
10	<p><b>CHECK HARNESS/CONNECTOR BETWEEN ABSCM&amp;H/U AND ABS WHEEL SPEED SENSOR.</b> 1) Connect the connector to ABS wheel speed sensor. 2) Disconnect the connector from ABSCM&amp;H/U. 3) Measure the resistance at ABSCM&amp;H/U connector terminals.</p> <p><b>Connector &amp; terminal</b> <b>DTC 22</b> <b>(B301) No. 11 — No. 12:</b> <b>DTC 24</b> <b>(B301) No. 9 — No. 10:</b> <b>DTC 26</b> <b>(B301) No. 14 — No. 15:</b> <b>DTC 28</b> <b>(B301) No. 7 — No. 8:</b></p>	Is the resistance as following value? Front: 1 — 1.5 kΩ Rear: 1.025 — 1.265 kΩ	Go to step 11.	Repair the harness/connector between ABSCM&H/U and ABS wheel speed sensor.
11	<p><b>CHECK GROUND SHORT OF HARNESS.</b> Measure the resistance between ABSCM&amp;H/U connector and chassis ground.</p> <p><b>Connector &amp; terminal</b> <b>DTC 22</b> <b>(B301) No. 11 — Chassis ground:</b> <b>DTC 24</b> <b>(B301) No. 9 — Chassis ground:</b> <b>DTC 26</b> <b>(B301) No. 14 — Chassis ground:</b> <b>DTC 28</b> <b>(B301) No. 7 — Chassis ground:</b></p>	Is the resistance more than 1 MΩ?	Go to step 12.	Repair the harness/connector between ABSCM&H/U and ABS wheel speed sensor.

# DIAGNOSTICS PROCEDURE WITHOUT SUBARU SELECT MONITOR

## ABS (DIAGNOSTICS)

Step	Check	Yes	No
<b>12 CHECK GROUND CIRCUIT OF ABSCM&amp;H/U.</b> Measure the resistance between ABSCM&H/U and chassis ground. <i>Connector &amp; terminal</i> <i>(B301) No. 23 — Chassis ground:</i>	Is the resistance less than 0.5 $\Omega$ ?	Go to step <b>13</b> .	Repair the ABSCM&H/U ground harness.
<b>13 CHECK POOR CONTACT IN CONNECTORS.</b>	Is there poor contact in connectors between ABSCM&H/U and ABS wheel speed sensor?	Go to step <b>14</b> .	Repair the connector.
<b>14 CHECK SOURCES OF SIGNAL NOISE.</b>	Is the car telephone or wireless transmitter properly installed?	Go to step <b>15</b> .	Properly install the car telephone or wireless transmitter.
<b>15 CHECK SOURCES OF SIGNAL NOISE.</b>	Are noise sources (such as an antenna) installed near the sensor harness?	Go to step <b>16</b> .	Install the noise sources apart from sensor harness.
<b>16 CHECK SHIELD CIRCUIT.</b> 1)Disconnect the connectors (B303). 2)Measure the resistance between shield connector and chassis ground. <i>Connector &amp; terminal</i> <i>DTC 22</i> <i>(B303) No. 2 — Chassis ground:</i> <i>DTC 24</i> <i>(B303) No. 1 — Chassis ground:</i> NOTE: If the DTC is 26, 28: Go to YES.	Is the resistance less than 0.5 $\Omega$ ?	Go to step <b>17</b> .	Repair the shield harness.
<b>17 CHECK ABSCM&amp;H/U.</b> 1)Connect all connectors. 2)Erase the memory. 3)Perform the inspection mode. 4)Read out the DTC.	Is the same DTC as in current diagnosis still being output?	Replace the ABSCM&H/U. <Ref. to ABS-6, ABS Control Module and Hydraulic Control Unit (ABSCM&H/U).>	Go to step <b>18</b> .
<b>18 CHECK ANY OTHER DTC APPEARANCE.</b>	Are other DTCs being output?	Proceed with the diagnosis corresponding to DTC.	A temporary noise interference. NOTE: Although the ABS warning light remains illuminating at this point, this is a normal condition. Vehicle must be driven at approx. 12 km/h (7.46 MPH) or faster to turn off ABS warning light. Make sure that the ABS warning light goes off after driving vehicle.

## **M: DTC 29**

### **— ABNORMAL ABS WHEEL SPEED SENSOR (ABNORMAL ABS WHEEL SPEED SENSOR SIGNAL) (ANY ONE OF FOUR) —**

#### **DIAGNOSIS:**

- Faulty ABS wheel speed sensor signal (noise, irregular signal, etc.)
- Faulty tone wheel
- Wheels turning freely for a long time

#### **TROUBLE SYMPTOM:**

- ABS does not operate.
- EBD does not operate.

#### **NOTE:**

In addition to the ABS warning light, brake warning light illuminates.

# DIAGNOSTICS PROCEDURE WITHOUT SUBARU SELECT MONITOR

ABS (DIAGNOSTICS)

## WIRING DIAGRAM:

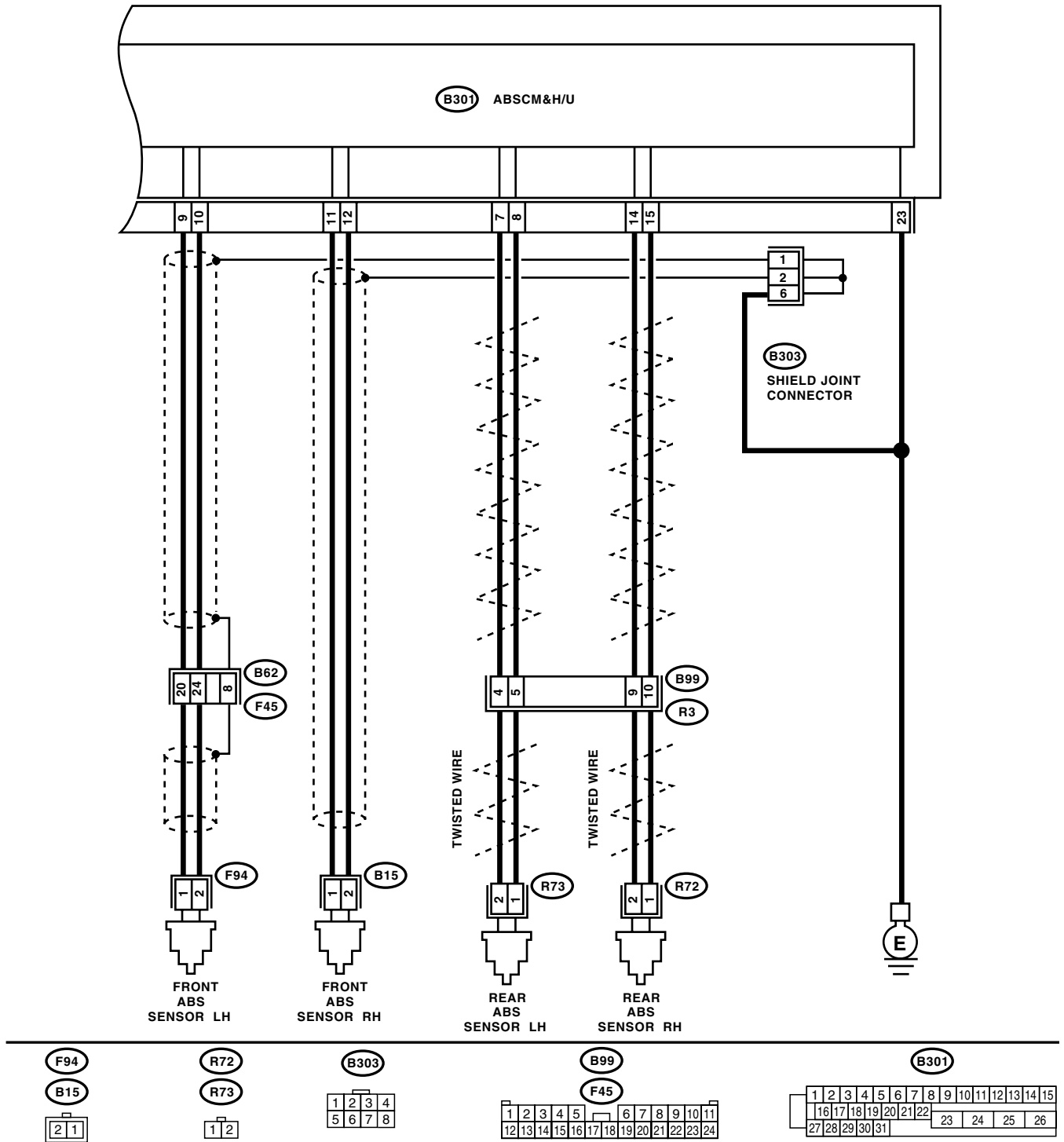

ABS00353

# DIAGNOSTICS PROCEDURE WITHOUT SUBARU SELECT MONITOR

ABS (DIAGNOSTICS)

Step	Check	Yes	No
<p><b>1 CHECK IF THE WHEELS HAVE TURNED FREELY FOR A LONG TIME.</b> Check if the wheels have been turned freely for more than 1 minute, such as when vehicle is jacked-up, under full-lock cornering or when tire is not in contact with road surface.</p>	Have the wheels been turned freely?	The ABS is normal. Erase the DTC. <b>NOTE:</b> When the wheels turn freely for a long time, such as when the vehicle is towed or jacked-up, or when steering wheel is continuously turned all the way, this DTC may sometimes occur.	Go to step 2.
<p><b>2 CHECK TIRE SPECIFICATIONS.</b> Turn the ignition switch to OFF.</p>	Are the tire specifications correct?	Go to step 3.	Replace the tire.
<p><b>3 CHECK WEAR OF TIRE.</b></p>	Is the tire worn excessively?	Replace tire.	Go to step 4.
<p><b>4 CHECK TIRE PRESSURE.</b></p>	Is the tire pressure correct?	Go to step 5.	Adjust tire pressure.
<p><b>5 CHECK INSTALLATION OF ABS WHEEL SPEED SENSOR.</b></p>	Are the ABS wheel speed sensor installation bolts tightened 33 N·m (3.3 kgf·m, 24 ft·lb)?	Go to step 6.	Tighten the ABS wheel speed sensor installation bolts securely.
<p><b>6 CHECK ABS WHEEL SPEED SENSOR GAP.</b> Measure the tone wheel to ABS wheel speed sensor piece gap over entire perimeter of the wheel.</p>	Is the gap as following value? Front wheel: 0.3 — 0.8 mm (0.012 — 0.031 in) Rear wheel: 0.7 — 1.2 mm (0.028 — 0.047 in)	Go to step 7.	Adjust the gap. <b>NOTE:</b> Adjust the gap using spacer (Part No. 26755AA000). If the spacer cannot correct gap, replace worn sensor or worn tone wheel.
<p><b>7 PREPARE OSCILLOSCOPE.</b></p>	Is an oscilloscope available?	Go to step 8.	Go to step 9.
<p><b>8 CHECK ABS WHEEL SPEED SENSOR SIGNAL.</b> 1)Raise all four wheels off ground. 2)Turn the ignition switch to OFF. 3)Connect the oscilloscope to the connector. 4)Turn the ignition switch to ON. 5)Rotate the wheels and measure voltage at specified frequency. &lt;Ref. to ABS-15, WAVEFORM, Control Module I/O Signal.&gt; <b>NOTE:</b> When this inspection is completed, the ABS-CM&amp;H/U sometimes stores the DTC 29.</p> <p><b>Connector &amp; terminal</b> <b>Front RH</b> (B15) No. 1 (+) — No. 2 (-): <b>Front LH</b> (F45) No. 20 (+) — No. 24 (-): <b>Rear RH</b> (B99) No. 10 (+) — No. 9 (-): <b>Rear LH</b> (B99) No. 5 (+) — No. 4 (-):</p>	Is an oscilloscope pattern smooth, as shown in the figure?	Go to step 12.	Go to step 9.

# DIAGNOSTICS PROCEDURE WITHOUT SUBARU SELECT MONITOR

## ABS (DIAGNOSTICS)

Step	Check	Yes	No
<b>9</b> <b>CHECK CONTAMINATION OF ABS WHEEL SPEED SENSOR OR TONE WHEEL.</b> Remove the disc rotor or drum from hub.	Is the ABS wheel speed sensor piece or the tone wheel contaminated by dirt or other foreign matter?	Thoroughly remove dirt or other foreign matter.	Go to step 10.
<b>10</b> <b>CHECK DAMAGE OF ABS WHEEL SPEED SENSOR OR TONE WHEEL.</b>	Are there broken or damaged teeth in the ABS wheel speed sensor piece or the tone wheel?	Replace the ABS wheel speed sensor or tone wheel. Front: <Ref. to ABS-12, Front ABS Wheel Speed Sensor.> Rear: <Ref. to ABS-15, Rear ABS Wheel Speed Sensor.> and Front: <Ref. to ABS-18, Front Tone Wheel.> Rear: <Ref. to ABS-19, Rear Tone Wheel.>	Go to step 11.
<b>11</b> <b>CHECK TONE WHEEL RUNOUT.</b> Measure the tone wheel runout.	Is the runout less than 0.05 mm (0.0020 in)?	Go to step 12.	Replace the tone wheel. Front: <Ref. to ABS-18, Front Tone Wheel.> Rear: <Ref. to ABS-19, Rear Tone Wheel.>
<b>12</b> <b>CHECK ABSCM&amp;H/U.</b> 1)Turn the ignition switch to OFF. 2)Connect all connectors. 3)Erase the memory. 4)Perform the inspection mode. 5)Read out the DTC.	Is the same DTC as in current diagnosis still being output?	Replace the ABSCM&H/U. <Ref. to ABS-6, ABS Control Module and Hydraulic Control Unit (ABSCM&H/U).>	Go to step 13.
<b>13</b> <b>CHECK ANY OTHER DTC APPEARANCE.</b>	Are other DTCs being output?	Proceed with the diagnosis corresponding to DTC.	A temporary poor contact.

**N: DTC 31**  
**— ABNORMAL INLET SOLENOID VALVE CIRCUIT(S) IN ABSCM&H/U**  
**(FRONT RH) —**

**NOTE:**

For the diagnostic procedure, refer to DTC 37. <Ref. to ABS-52, DTC 37 — ABNORMAL INLET SOLENOID VALVE CIRCUIT(S) IN ABSCM&H/U (REAR LH) —, Diagnostics Procedure without Subaru Select Monitor.>

**O: DTC 33**  
**— ABNORMAL INLET SOLENOID VALVE CIRCUIT(S) IN ABSCM&H/U**  
**(FRONT LH) —**

**NOTE:**

For the diagnostic procedure, refer to DTC 37. <Ref. to ABS-52, DTC 37 — ABNORMAL INLET SOLENOID VALVE CIRCUIT(S) IN ABSCM&H/U (REAR LH) —, Diagnostics Procedure without Subaru Select Monitor.>

**P: DTC 35**  
**— ABNORMAL INLET SOLENOID VALVE CIRCUIT(S) IN ABSCM&H/U**  
**(REAR RH) —**

**NOTE:**

For the diagnostic procedure, refer to DTC 37. <Ref. to ABS-52, DTC 37 — ABNORMAL INLET SOLENOID VALVE CIRCUIT(S) IN ABSCM&H/U (REAR LH) —, Diagnostics Procedure without Subaru Select Monitor.>



## DIAGNOSTICS PROCEDURE WITHOUT SUBARU SELECT MONITOR

ABS (DIAGNOSTICS)

---

### **Q: DTC 37**

**— ABNORMAL INLET SOLENOID VALVE CIRCUIT(S) IN ABSCM&H/U  
(REAR LH) —**

#### **DIAGNOSIS:**

- Faulty harness/connector
- Faulty inlet solenoid valve in ABSCM&H/U

#### **TROUBLE SYMPTOM:**

- ABS does not operate.
- EBD does not operate.

#### **NOTE:**

In addition to the ABS warning light, brake warning light illuminates.

# DIAGNOSTICS PROCEDURE WITHOUT SUBARU SELECT MONITOR

ABS (DIAGNOSTICS)

## WIRING DIAGRAM:

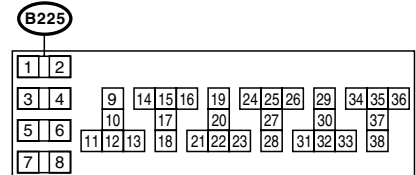
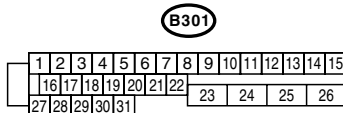
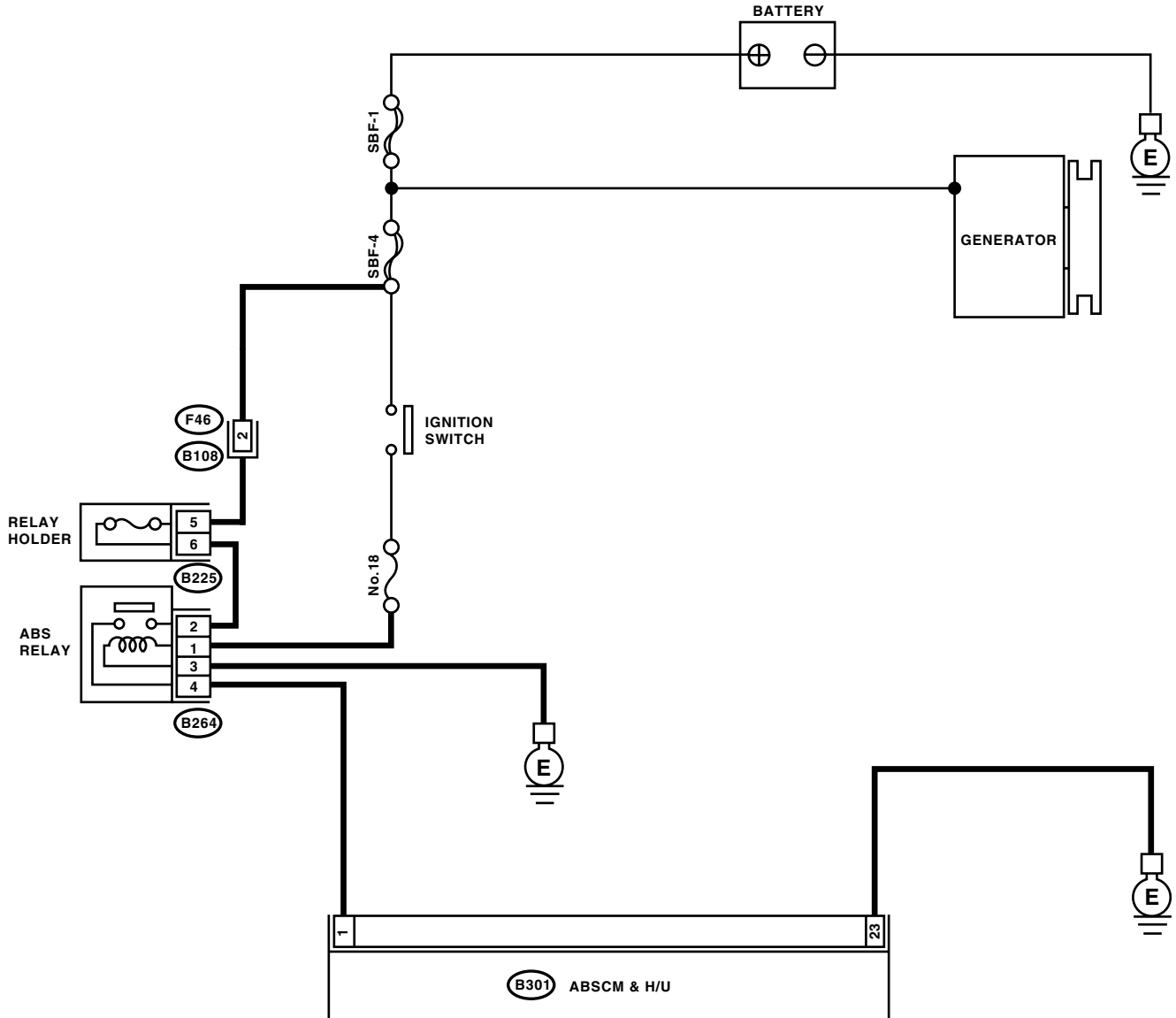

ABS00322

# DIAGNOSTICS PROCEDURE WITHOUT SUBARU SELECT MONITOR

## ABS (DIAGNOSTICS)

Step	Check	Yes	No
<b>1 CHECK INPUT VOLTAGE OF ABSCM&amp;H/U.</b> 1) Turn the ignition switch to OFF. 2) Disconnect the connector from ABSCM&H/U. 3) Run the engine at idle. 4) Measure the voltage between ABSCM&H/U connector and chassis ground. <i><b>Connector &amp; terminal</b></i> <i><b>(B301) No. 1 (+) — Chassis ground (-):</b></i>	Is the voltage 10 — 15 V?	Go to step 2.	Repair the power supply circuit and ABSCM&H/U.
<b>2 CHECK GROUND CIRCUIT OF ABSCM&amp;H/U.</b> 1) Turn the ignition switch to OFF. 2) Measure the resistance between ABSCM&H/U connector and chassis ground. <i><b>Connector &amp; terminal</b></i> <i><b>(B301) No. 23 — Chassis ground:</b></i>	Is the resistance less than 0.5 Ω?	Go to step 3.	Repair the ABSCM&H/U ground harness.
<b>3 CHECK POOR CONTACT IN CONNECTORS.</b>	Is there poor contact in connectors between generator, battery and ABSCM&H/U?	Repair the connector.	Go to step 4.
<b>4 CHECK ABSCM&amp;H/U.</b> 1) Connect all connectors. 2) Erase the memory. 3) Perform the inspection mode. 4) Read out the DTC.	Is the same DTC as in the current diagnosis still being output?	Replace the ABSCM&H/U. <Ref. to ABS-6, ABS Control Module and Hydraulic Control Unit (ABSCM&H/U).>	Go to step 5.
<b>5 CHECK ANY OTHER DTC APPEARANCE.</b>	Are other DTCs being output?	Proceed with the diagnosis corresponding to DTC.	A temporary poor contact.

### **R: DTC 32** **— ABNORMAL OUTLET SOLENOID VALVE CIRCUIT(S) IN ABSCM&H/U (FRONT RH) —**

**NOTE:**

For the diagnostic procedure, refer to DTC 38. <Ref. to ABS-55, DTC 38 — ABNORMAL OUTLET SOLENOID VALVE CIRCUIT(S) IN ABSCM&H/U (REAR LH) —, Diagnostics Procedure without Subaru Select Monitor.>

### **S: DTC 34** **— ABNORMAL OUTLET SOLENOID VALVE CIRCUIT(S) IN ABSCM&H/U (FRONT LH) —**

**NOTE:**

For the diagnostic procedure, refer to DTC 38. <Ref. to ABS-55, DTC 38 — ABNORMAL OUTLET SOLENOID VALVE CIRCUIT(S) IN ABSCM&H/U (REAR LH) —, Diagnostics Procedure without Subaru Select Monitor.>

### **T: DTC 36** **— ABNORMAL OUTLET SOLENOID VALVE CIRCUIT(S) IN ABSCM&H/U (REAR RH) —**

**NOTE:**

For the diagnostic procedure, refer to DTC 38. <Ref. to ABS-55, DTC 38 — ABNORMAL OUTLET SOLENOID VALVE CIRCUIT(S) IN ABSCM&H/U (REAR LH) —, Diagnostics Procedure without Subaru Select Monitor.>

**U: DTC 38**

**— ABNORMAL OUTLET SOLENOID VALVE CIRCUIT(S) IN ABSCM&H/U  
(REAR LH) —**

**DIAGNOSIS:**

- Faulty harness/connector
- Faulty outlet solenoid valve in ABSCM&H/U

**TROUBLE SYMPTOM:**

- ABS does not operate.
- EBD does not operate.

**NOTE:**

In addition to the ABS warning light, brake warning light illuminates.

# DIAGNOSTICS PROCEDURE WITHOUT SUBARU SELECT MONITOR

ABS (DIAGNOSTICS)

## WIRING DIAGRAM:

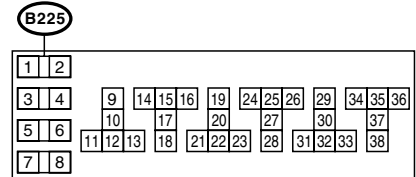
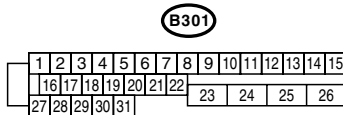
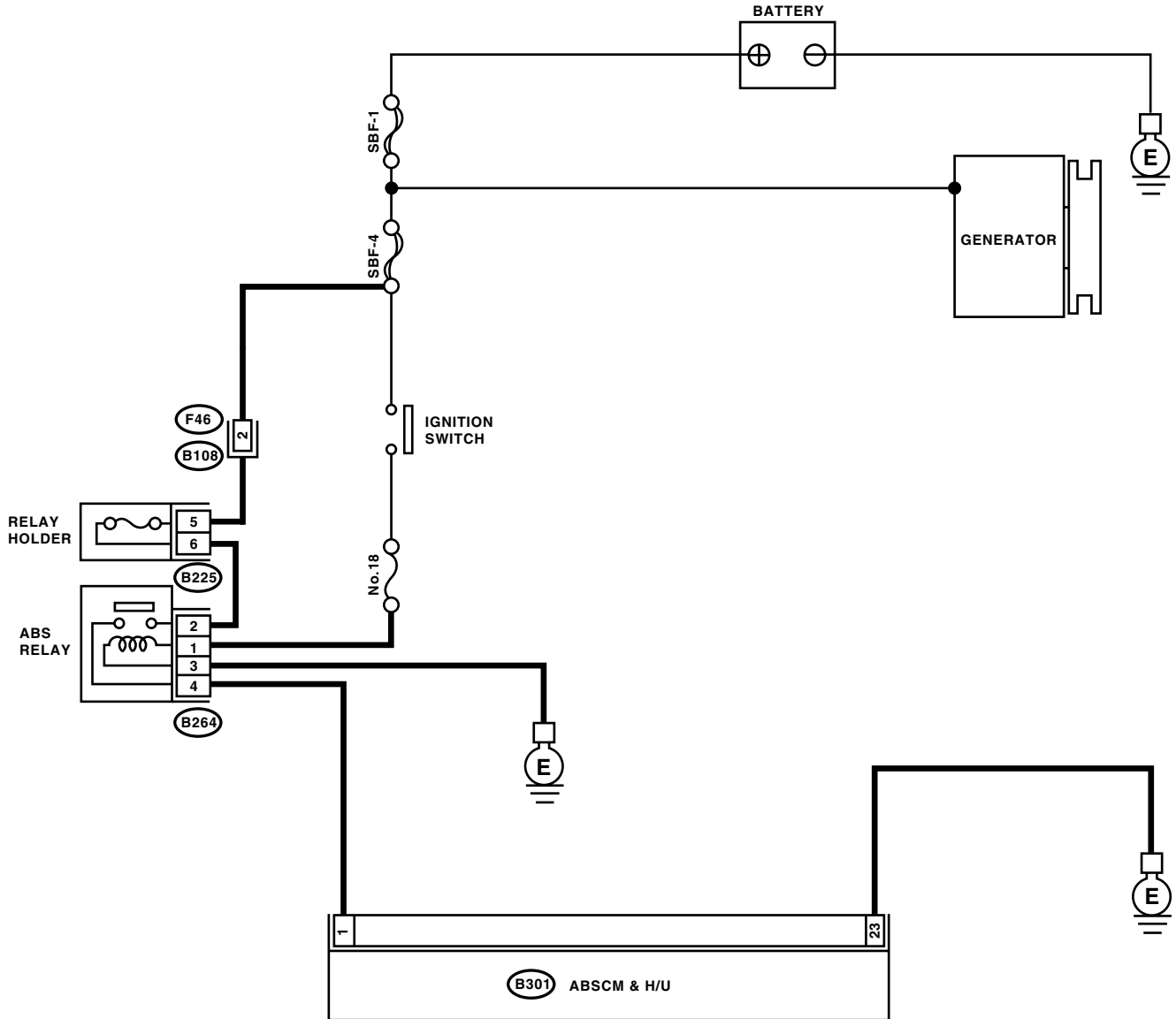

ABS00322

# DIAGNOSTICS PROCEDURE WITHOUT SUBARU SELECT MONITOR

ABS (DIAGNOSTICS)

Step	Check	Yes	No
<b>1</b> <b>CHECK INPUT VOLTAGE OF ABSCM&amp;H/U.</b> 1) Turn the ignition switch to OFF. 2) Disconnect the connector from ABSCM&H/U. 3) Run the engine at idle. 4) Measure the voltage between ABSCM&H/U connector and chassis ground. <b>Connector &amp; terminal</b> <b>(B301) No. 1 (+) — Chassis ground (-):</b>	Is the voltage 10 — 15 V?	Go to step 2.	Repair the power supply circuit and ABSCM&H/U.
<b>2</b> <b>CHECK GROUND CIRCUIT OF ABSCM&amp;H/U.</b> 1) Turn the ignition switch to OFF. 2) Measure the resistance between ABSCM&H/U connector and chassis ground. <b>Connector &amp; terminal</b> <b>(B301) No. 23 — Chassis ground:</b>	Is the resistance less than 0.5 Ω?	Go to step 3.	Repair the ABSCM&H/U ground harness.
<b>3</b> <b>CHECK POOR CONTACT IN CONNECTORS.</b>	Is there poor contact in connectors between generator, battery and ABSCM&H/U?	Repair the connector.	Go to step 4.
<b>4</b> <b>CHECK ABSCM&amp;H/U.</b> 1) Connect all connectors. 2) Erase the memory. 3) Perform the inspection mode. 4) Read out the DTC.	Is the same DTC as in the current diagnosis still being output?	Replace the ABSCM&H/U. <Ref. to ABS-6, ABS Control Module and Hydraulic Control Unit (ABSCM&H/U).>	Go to step 5.
<b>5</b> <b>CHECK ANY OTHER DTC APPEARANCE.</b>	Are other DTCs being output?	Proceed with the diagnosis corresponding to DTC.	A temporary poor contact.

# DIAGNOSTICS PROCEDURE WITHOUT SUBARU SELECT MONITOR

ABS (DIAGNOSTICS)

## V: DTC 41 — ABNORMAL ABS CONTROL MODULE —

### DIAGNOSIS:

- Faulty ABSCM&H/U.

### TROUBLE SYMPTOM:

- ABS does not operate.
- EBD does not operate.

### NOTE:

In addition to the ABS warning light, brake warning light illuminates.

### WIRING DIAGRAM:

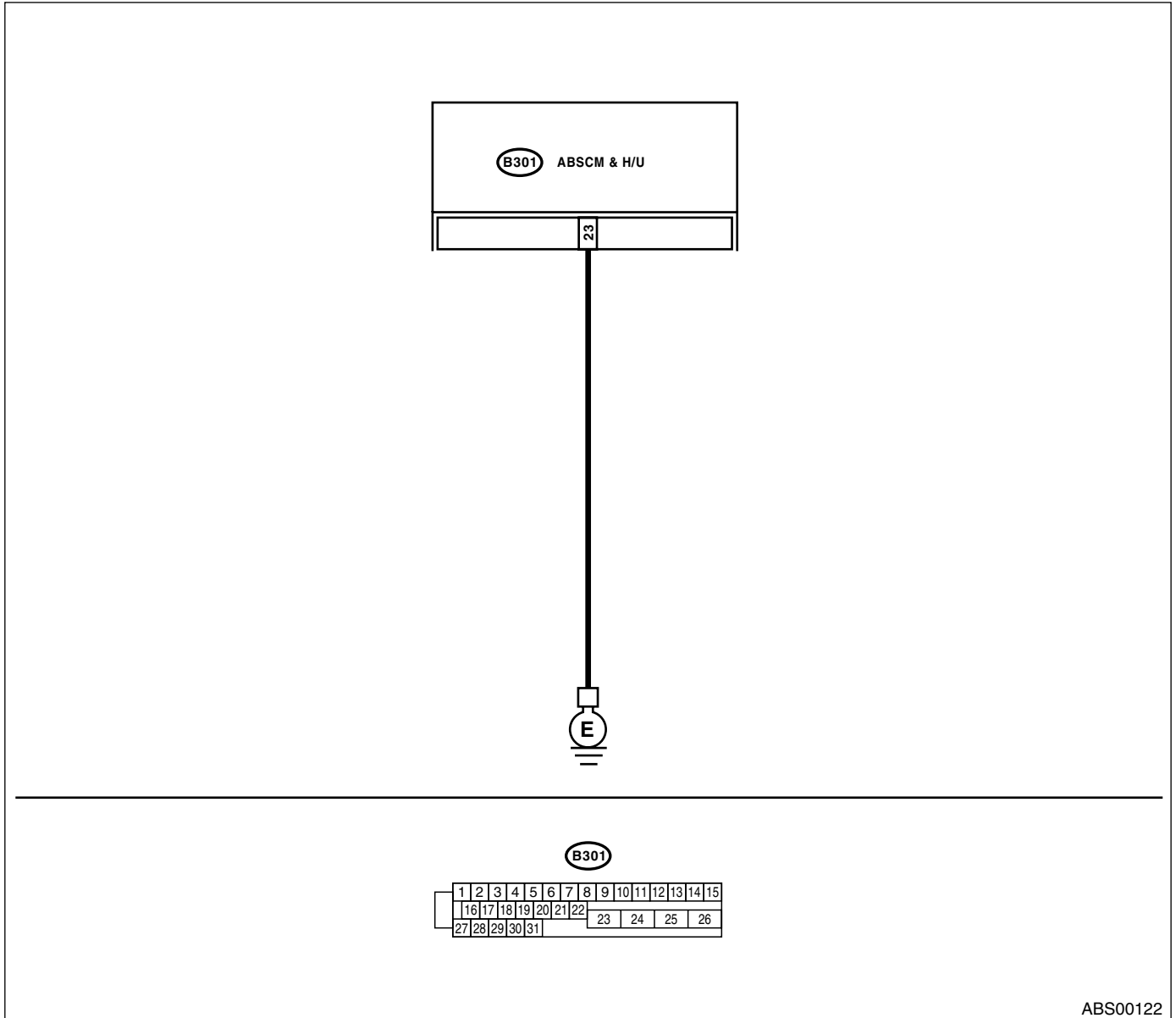

ABS00122

# DIAGNOSTICS PROCEDURE WITHOUT SUBARU SELECT MONITOR

ABS (DIAGNOSTICS)

Step	Check	Yes	No	
1	<b>CHECK GROUND CIRCUIT OF ABSCM&amp;H/U.</b> 1) Turn the ignition switch to OFF. 2) Disconnect the connector from ABSCM&H/U. 3) Measure the resistance between ABSCM&H/U and chassis ground. <i>Connector &amp; terminal (B301) No. 23 — Chassis ground:</i>	Is the resistance less than 0.5 $\Omega$ ?	Go to step 2.	Repair the ABSCM&H/U ground harness.
2	<b>CHECK POOR CONTACT IN CONNECTORS.</b>	Is there poor contact in connectors between battery, ignition switch and ABSCM&H/U?	Repair the connector.	Go to step 3.
3	<b>CHECK SOURCES OF SIGNAL NOISE.</b>	Is the car telephone or the wireless transmitter properly installed?	Go to step 4.	Properly install the car telephone or wireless transmitter.
4	<b>CHECK SOURCES OF SIGNAL NOISE.</b>	Are noise sources (such as an antenna) installed near the sensor harness?	Install the noise sources apart from the sensor harness.	Go to step 5.
5	<b>CHECK ABSCM&amp;H/U.</b> 1) Connect all connectors. 2) Erase the memory. 3) Perform the inspection mode. 4) Read out the DTC.	Is the same DTC as in current diagnosis still being output?	Replace the ABSCM&H/U. <Ref. to ABS-6, ABS Control Module and Hydraulic Control Unit (ABSCM&H/U).>	Go to step 6.
6	<b>CHECK ANY OTHER DTC APPEARANCE.</b>	Are other DTCs being output?	Proceed with the diagnosis corresponding to DTC.	A temporary poor contact.



# DIAGNOSTICS PROCEDURE WITHOUT SUBARU SELECT MONITOR

ABS (DIAGNOSTICS)

---

## **W: DTC 42**

### **— SOURCE VOLTAGE IS ABNORMAL —**

#### **DIAGNOSIS:**

- Power source voltage of the ABSCM&H/U is low or high.

#### **TROUBLE SYMPTOM:**

- ABS does not operate.
- EBD does not operate.

#### **NOTE:**

In addition to the ABS warning light, brake warning light illuminates temporarily. Both warning lights go off on the recovery of voltage.



# DIAGNOSTICS PROCEDURE WITHOUT SUBARU SELECT MONITOR

## ABS (DIAGNOSTICS)

Step	Check	Yes	No
<b>1 CHECK GENERATOR.</b> 1)Start the engine. 2)Idle after warm-up. 3)Measure the voltage between generator B terminal and chassis ground. <b>Terminals</b> <b>Generator B terminal (+) — Chassis ground (-):</b>	Is the voltage 10 — 17 V?	Go to step 2.	Repair the generator. <Ref. to SC(H4SO)-14, Generator.>
<b>2 CHECK BATTERY TERMINAL.</b> Turn the ignition switch to OFF.	Are the positive and negative battery terminals tightly clamped?	Go to step 3.	Tighten the clamp of terminal.
<b>3 CHECK INPUT VOLTAGE OF ABSCM&amp;H/U.</b> 1)Disconnect the connector from ABSCM&H/U. 2)Run the engine at idle. 3)Operate the electric load applying devices, such as the headlight, A/C, and defogger. 4)Measure the voltage between ABSCM&H/U connector and chassis ground. <b>Connector &amp; terminal</b> <b>(B301) No. 1 (+) — Chassis ground (-):</b>	Is the voltage 10 — 17 V?	Go to step 4.	Repair the power supply circuit and ABSCM&H/U.
<b>4 CHECK GROUND CIRCUIT OF ABSCM&amp;H/U.</b> 1)Turn the ignition switch to OFF. 2)Measure the resistance between ABSCM&H/U connector and chassis ground. <b>Connector &amp; terminal</b> <b>(B301) No. 23 — Chassis ground:</b>	Is the resistance less than 0.5 $\Omega$ ?	Go to step 5.	Repair the ABSCM&H/U ground harness.
<b>5 CHECK POOR CONTACT IN CONNECTORS.</b>	Is there poor contact in connectors between generator, battery and ABSCM&H/U?	Repair the connector.	Go to step 6.
<b>6 CHECK ABSCM&amp;H/U.</b> 1)Connect all connectors. 2)Erase the memory. 3)Perform the inspection mode. 4)Read out the DTC.	Is the same DTC as in current diagnosis still being output?	Replace the ABSCM&H/U. <Ref. to ABS-6, ABS Control Module and Hydraulic Control Unit (ABSCM&H/U).>	Go to step 7.
<b>7 CHECK ANY OTHER DTC APPEARANCE.</b>	Are other DTCs being output?	Proceed with the diagnosis corresponding to DTC.	A temporary poor contact.

# DIAGNOSTICS PROCEDURE WITHOUT SUBARU SELECT MONITOR

ABS (DIAGNOSTICS)

## X: DTC 44

### — A COMBINATION OF AT CONTROL ABNORMAL —

#### DIAGNOSIS:

- Combination of AT control faults

#### TROUBLE SYMPTOM:

- ABS does not operate.

#### WIRING DIAGRAM:

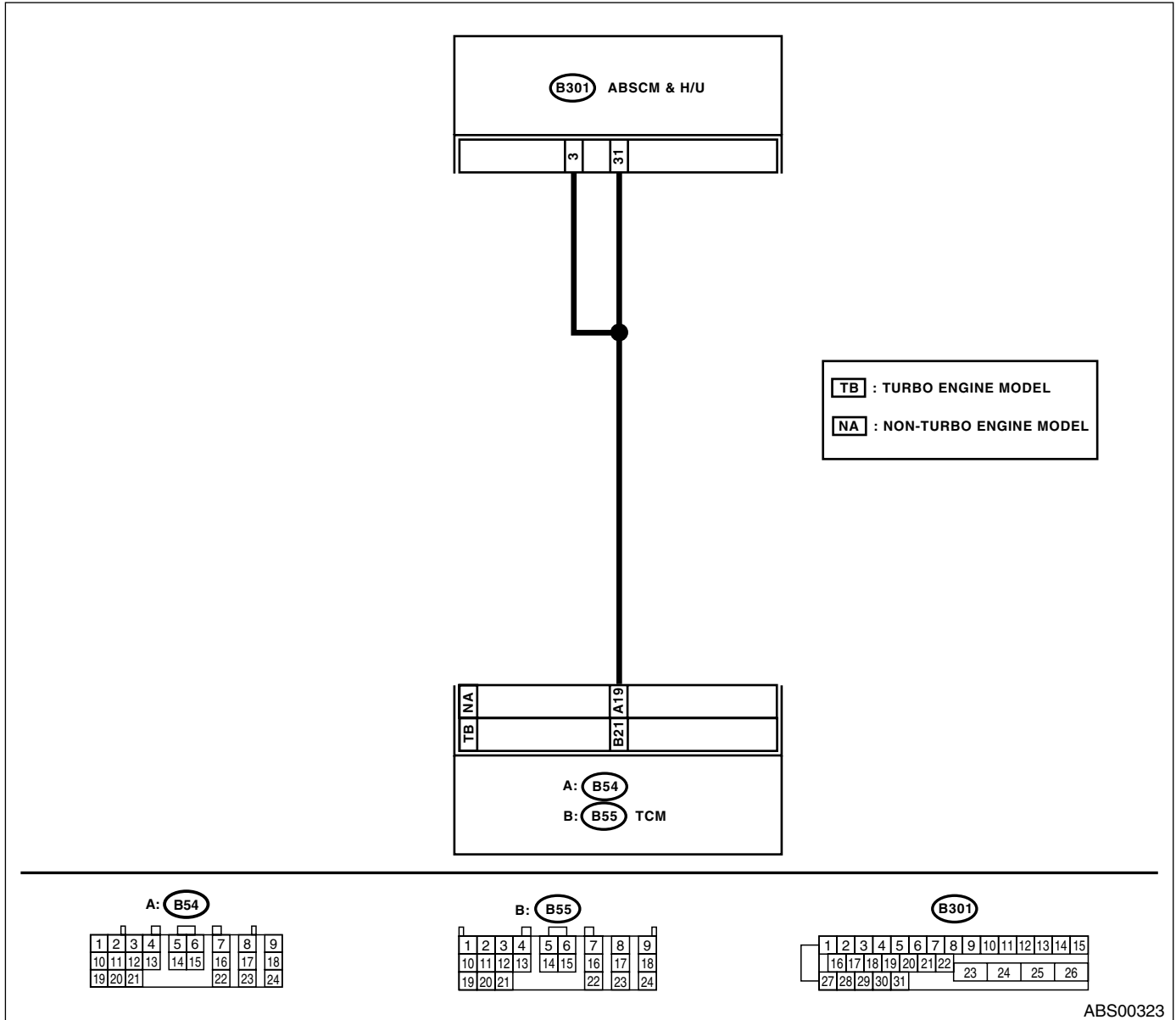

ABS00323

Step	Check	Yes	No	
1	<p><b>CHECK SPECIFICATIONS OF THE AB-SCM&amp;H/U.</b> Check the specifications of mark on ABSCM&amp;H/U. <b>CU: AT</b> <b>CV: MT (Except STi model)</b> <b>CY: MT (STi model)</b></p>	Specifications between vehicle and ABSCM&H/U are matched?	Go to step 2.	Replace the ABSCM&H/U. <Ref. to ABS-6, ABS Control Module and Hydraulic Control Unit (ABSCM&H/U).>

# DIAGNOSTICS PROCEDURE WITHOUT SUBARU SELECT MONITOR

## ABS (DIAGNOSTICS)

Step	Check	Yes	No
<b>2 CHECK GROUND SHORT OF HARNESS.</b> 1) Turn the ignition switch to OFF. 2) Disconnect all connectors from TCM. 3) Disconnect the connector from ABSCM&H/U. 4) Measure the resistance between ABSCM&H/U connector and chassis ground. <i><b>Connector &amp; terminal</b></i> <i><b>(B301) No. 3 — Chassis ground:</b></i>	Is the resistance more than 1 MΩ?	Go to step 3.	Repair the harness between TCM and ABSCM&H/U.
<b>3 CHECK BATTERY SHORT OF HARNESS.</b> Measure the voltage between ABSCM&H/U connector and chassis ground. <i><b>Connector &amp; terminal</b></i> <i><b>(B301) No. 3 (+) — Chassis ground (-):</b></i>	Is the voltage less than 1 V?	Go to step 4.	Repair the harness between TCM and ABSCM&H/U.
<b>4 CHECK BATTERY SHORT OF HARNESS.</b> 1) Turn the ignition switch to ON. 2) Measure the voltage between ABSCM&H/U connector and chassis ground. <i><b>Connector &amp; terminal</b></i> <i><b>(B301) No. 3 (+) — Chassis ground (-):</b></i>	Is the voltage less than 1 V?	Go to step 5.	Repair the harness between TCM and ABSCM&H/U.
<b>5 CHECK TCM.</b> 1) Turn the ignition switch to OFF. 2) Connect all connectors to TCM. 3) Turn the ignition switch to ON. 4) Measure the voltage between TCM connector terminal and chassis ground. <i><b>Connector &amp; terminal</b></i> <i><b>Non-turbo model</b></i> <i><b>(B54) No. 19 (+) — Chassis ground (-):</b></i> <i><b>Turbo model</b></i> <i><b>(B55) No. 21 (+) — Chassis ground (-):</b></i>	Is the voltage 10 — 15 V?	Go to step 7.	Go to step 6.
<b>6 CHECK AT.</b>	Is the AT functioning normally?	Replace the TCM.	Repair the AT.
<b>7 CHECK OPEN CIRCUIT OF HARNESS.</b> Measure the voltage between ABSCM&H/U connector and chassis ground. <i><b>Connector &amp; terminal</b></i> <i><b>(B301) No. 3 (+) — Chassis ground (-):</b></i> <i><b>(B301) No. 31 (+) — Chassis ground (-):</b></i>	Is the voltage 10 — 15 V?	Go to step 8.	Repair the harness/connector between TCM and ABSCM&H/U.
<b>8 CHECK POOR CONTACT IN CONNECTORS.</b>	Is there poor contact in connectors between TCM and ABSCM&H/U?	Repair the connector.	Go to step 9.
<b>9 CHECK ABSCM&amp;H/U.</b> 1) Turn the ignition switch to OFF. 2) Connect all connectors. 3) Erase the memory. 4) Perform the inspection mode. 5) Read out the DTC.	Is the same DTC as in the current diagnosis still being output?	Replace the ABSCM&H/U. <Ref. to ABS-6, ABS Control Module and Hydraulic Control Unit (ABSCM&H/U).>	Go to step 10.
<b>10 CHECK ANY OTHER DTC APPEARANCE.</b>	Are other DTCs being output?	Proceed with the diagnosis corresponding to DTC.	A temporary poor contact.

## **Y: DTC 51**

### **— ABNORMAL VALVE RELAY —**

#### **DIAGNOSIS:**

- Faulty valve relay

#### **TROUBLE SYMPTOM:**

- ABS does not operate.
- EBD does not operate in some malfunctions.

#### **NOTE:**

In addition to the ABS warning light, brake warning light illuminates, if the EBD does not operate.



# DIAGNOSTICS PROCEDURE WITHOUT SUBARU SELECT MONITOR

ABS (DIAGNOSTICS)

Step	Check	Yes	No
<b>1 CHECK INPUT VOLTAGE OF ABSCM&amp;H/U.</b> 1) Turn the ignition switch to OFF. 2) Disconnect the connector from ABSCM&H/U. 3) Run the engine at idle. 4) Measure the voltage between ABSCM&H/U connector and chassis ground. <i><b>Connector &amp; terminal</b></i> <i><b>(B301) No. 1 (+) — Chassis ground (-):</b></i> <i><b>(B301) No. 24 (+) — Chassis ground (-):</b></i>	Is the voltage 10 — 15 V?	Go to step 2.	Repair the harness connector between battery, ABS relay and ABSCM&H/U.
<b>2 CHECK GROUND CIRCUIT OF ABSCM&amp;H/U.</b> 1) Turn the ignition switch to OFF. 2) Measure the resistance between ABSCM&H/U connector and chassis ground. <i><b>Connector &amp; terminal</b></i> <i><b>(B301) No. 23 — Chassis ground:</b></i>	Is the resistance less than 0.5 $\Omega$ ?	Go to step 3.	Repair the ABSCM&H/U ground harness.
<b>3 CHECK VALVE RELAY IN ABSCM&amp;H/U.</b> Measure the resistance between ABSCM&H/U and terminals. <i><b>Terminals</b></i> <i><b>No. 23 — No. 24:</b></i>	Is the resistance more than 1 $M\Omega$ ?	Go to step 4.	Replace the ABSCM&H/U. <Ref. to ABS-6, ABS Control Module and Hydraulic Control Unit (ABSCM&H/U).>
<b>4 CHECK POOR CONTACT IN CONNECTORS.</b>	Is there poor contact in connectors between generator, battery and ABSCM&H/U?	Repair the connector.	Go to step 5.
<b>5 CHECK ABSCM&amp;H/U.</b> 1) Connect all connectors. 2) Erase the memory. 3) Perform the inspection mode. 4) Read out the DTC.	Is the same DTC as in the current diagnosis still being output?	Replace the ABSCM&H/U. <Ref. to ABS-6, ABS Control Module and Hydraulic Control Unit (ABSCM&H/U).>	Go to step 6.
<b>6 CHECK ANY OTHER DTC APPEARANCE.</b>	Are other DTCs being output?	Proceed with the diagnosis corresponding to DTC.	A temporary poor contact.





# DIAGNOSTICS PROCEDURE WITHOUT SUBARU SELECT MONITOR

ABS (DIAGNOSTICS)

Step	Check	Yes	No
<b>1 CHECK INPUT VOLTAGE OF ABSCM&amp;H/U.</b> 1)Turn the ignition switch to OFF. 2)Disconnect the connector from ABSCM&H/U. 3)Turn the ignition switch to ON. 4)Measure the voltage between ABSCM&H/U connector and chassis ground. <b>Connector &amp; terminal</b> <b>(B301) No. 25 (+) — Chassis ground (-):</b>	Is the voltage 10 — 15 V?	Go to step 2.	Repair the harness/connector between battery and ABSCM&H/U and check fuse SBF-holder.
<b>2 CHECK GROUND CIRCUIT OF MOTOR.</b> 1)Turn the ignition switch to OFF. 2)Measure the resistance between ABSCM&H/U connector and chassis ground. <b>Connector &amp; terminal</b> <b>(B301) No. 26 — Chassis ground:</b>	Is the resistance less than 0.5 $\Omega$ ?	Go to step 3.	Repair the ABSCM&H/U ground harness.
<b>3 CHECK INPUT VOLTAGE OF ABSCM&amp;H/U.</b> 1)Run the engine at idle. 2)Measure the voltage between ABSCM&H/U connector and chassis ground. <b>Connector &amp; terminal</b> <b>(B301) No. 1 (+) — Chassis ground (-):</b>	Is the voltage 10 — 15 V?	Go to step 4.	Repair the harness connector between battery, ignition switch and ABSCM&H/U.
<b>4 CHECK GROUND CIRCUIT OF ABSCM&amp;H/U.</b> 1)Turn the ignition switch to OFF. 2)Measure the resistance between ABSCM&H/U connector and chassis ground. <b>Connector &amp; terminal</b> <b>(B301) No. 23 — Chassis ground:</b>	Is the resistance less than 0.5 $\Omega$ ?	Go to step 5.	Repair the ABSCM&H/U ground harness.
<b>5 CHECK MOTOR OPERATION.</b> Operate the sequence control. <Ref. to ABS-9, ABS Sequence Control.> NOTE: Use the diagnosis connector to operate the sequence control.	Can motor revolution noise (buzz) be heard when carrying out the sequence control?	Go to step 6.	Replace the ABSCM&H/U. <Ref. to ABS-6, ABS Control Module and Hydraulic Control Unit (ABSCM&H/U).>
<b>6 CHECK POOR CONTACT IN CONNECTORS.</b> Turn the ignition switch to OFF.	Is there poor contact in connector between generator, battery and ABSCM&H/U?	Repair the connector.	Go to step 7.
<b>7 CHECK ABSCM&amp;H/U.</b> 1)Connect all connectors. 2)Erase the memory. 3)Perform the inspection mode. 4)Read out the DTC.	Is the same DTC as in the current diagnosis still being output?	Replace the ABSCM&H/U. <Ref. to ABS-6, ABS Control Module and Hydraulic Control Unit (ABSCM&H/U).>	Go to step 8.

# DIAGNOSTICS PROCEDURE WITHOUT SUBARU SELECT MONITOR

## ABS (DIAGNOSTICS)

Step	Check	Yes	No
<b>8</b> <b>CHECK ANY OTHER DTC APPEARANCE.</b>	Are other DTCs being output?	Proceed with the diagnosis corresponding to DTC.	A temporary poor contact. NOTE: Although the ABS warning light remains illuminating at this point, this is a normal condition. Vehicle must be driven at approx. 12 km/h (7.46 MPH) or faster to turn off ABS warning light. Make sure that the ABS warning light goes off after driving vehicle.

## AA:DTC 54 — ABNORMAL STOP LIGHT SWITCH —

### DIAGNOSIS:

- Faulty stop light switch

### TROUBLE SYMPTOM:

- ABS does not operate.

### WIRING DIAGRAM:

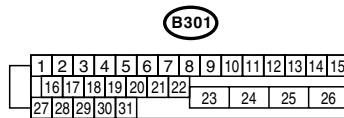
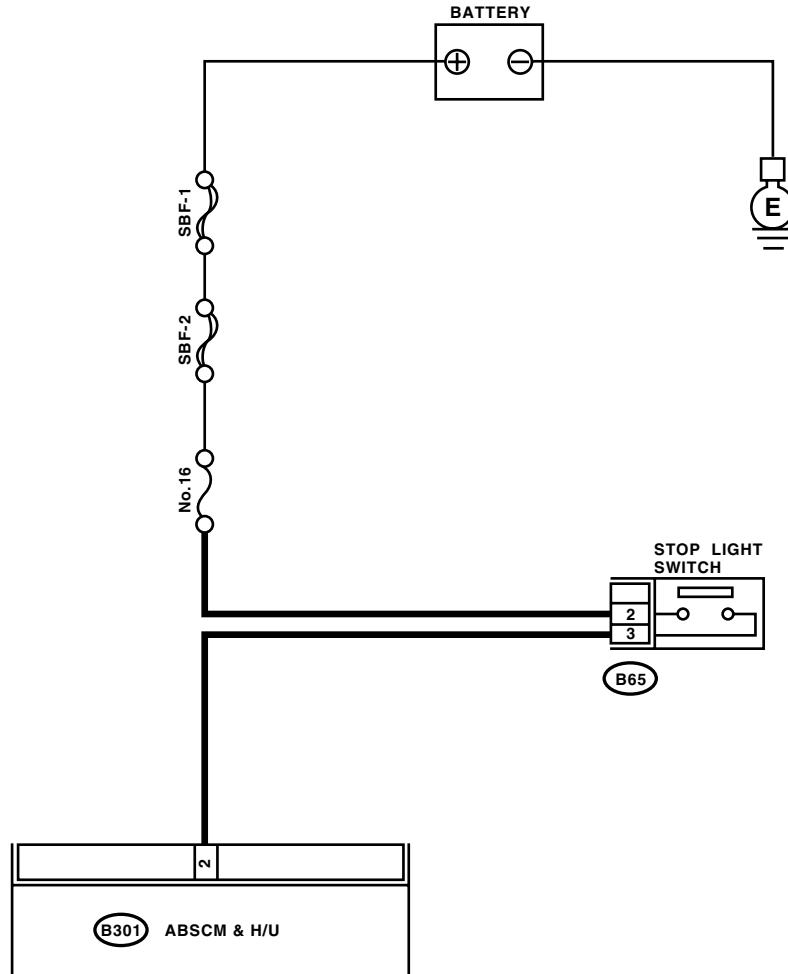

# DIAGNOSTICS PROCEDURE WITHOUT SUBARU SELECT MONITOR

## ABS (DIAGNOSTICS)

	Step	Check	Yes	No
1	<b>CHECK STOP LIGHTS COME ON.</b> Depress the brake pedal.	Do the stop lights come on?	Go to step 2.	Repair the stop lights circuit.
2	<b>CHECK OPEN CIRCUIT IN HARNESS.</b> 1) Turn the ignition switch to OFF. 2) Disconnect the connector from ABSCM&H/U. 3) Depress the brake pedal. 4) Measure the voltage between ABSCM&H/U connector and chassis ground. <b>Connector &amp; terminal</b> <b>(B301) No. 2 (+) — Chassis ground (-):</b>	Is the voltage 10 — 15 V?	Go to step 3.	Repair the harness between stop light switch and ABSCM&H/U.
3	<b>CHECK POOR CONTACT IN CONNECTORS.</b>	Is there poor contact in connector between stop light switch and ABSCM&H/U?	Repair the connector.	Go to step 4.
4	<b>CHECK ABSCM&amp;H/U.</b> 1) Connect all connectors. 2) Erase the memory. 3) Perform the inspection mode. 4) Read out the DTC.	Is the same DTC as in the current diagnosis still being output?	Replace the ABSCM&H/U. <Ref. to ABS-6, ABS Control Module and Hydraulic Control Unit (ABSCM&H/U).>	Go to step 5.
5	<b>CHECK ANY OTHER DTC APPEARANCE.</b>	Are other DTCs being output?	Proceed with the diagnosis corresponding to DTC.	A temporary poor contact.

## AB:DTC 56

### — ABNORMAL G SENSOR OUTPUT VOLTAGE —

#### DIAGNOSIS:

- Faulty G sensor output voltage

#### TROUBLE SYMPTOM:

- ABS does not operate.

#### WIRING DIAGRAM:

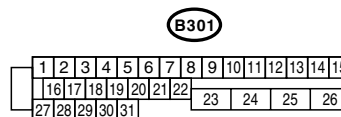
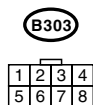
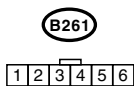
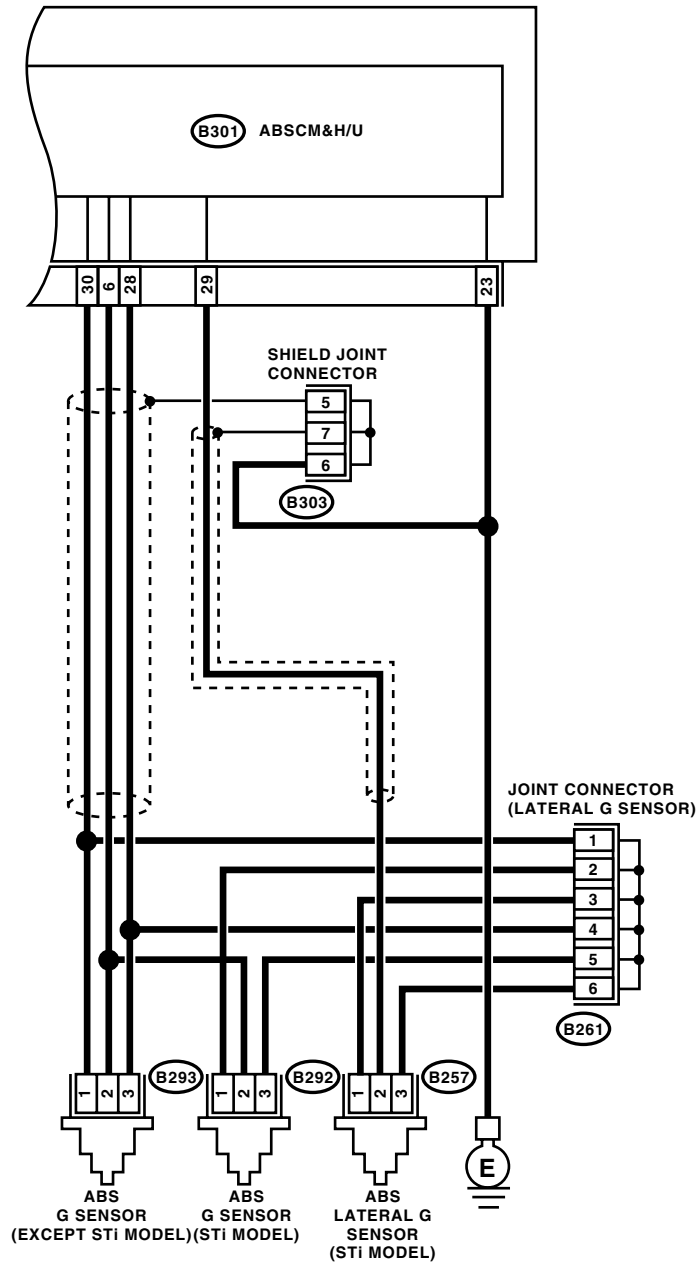

# DIAGNOSTICS PROCEDURE WITHOUT SUBARU SELECT MONITOR

## ABS (DIAGNOSTICS)

Step	Check	Yes	No	
<b>1</b>	<b>CHECK ALL FOUR WHEELS FOR FREE TURNING.</b>	Have the wheels been turned freely such as when the vehicle is lifted up, or operated on a free roller or rolling road?	The ABS is normal. Erase the DTC.	Go to step 2.
<b>2</b>	<b>CHECK SPECIFICATIONS OF ABSCM&amp;H/U.</b> Check the specifications of mark on ABSCM&H/U. <b>CU: AT</b> <b>CV: MT (Except STi model)</b> <b>CY: MT (STi model)</b>	Does the vehicle specification and ABSCM&H/U specification match?	Go to step 3.	Replace the ABSCM&H/U. <Ref. to ABS-6, ABS Control Module and Hydraulic Control Unit (ABSCM&H/U).>
<b>3</b>	<b>CHECK INPUT VOLTAGE OF G SENSOR.</b> 1) Turn the ignition switch to OFF. 2) Remove the console box. 3) Remove the G sensor from vehicle. (Do not disconnect the connector.) 4) Turn the ignition switch to ON. 5) Measure the voltage between G sensor connector terminals. <b>Connector &amp; terminal</b> <b>(B292) No. 1 (+) — No. 3 (-):</b>	Is the voltage 4.75 — 5.25 V?	Go to step 4.	Repair the harness/connector between G sensor and ABSCM&H/U.
<b>4</b>	<b>CHECK OPEN CIRCUIT IN G SENSOR OUTPUT HARNESS AND GROUND HARNESS.</b> 1) Turn the ignition switch to OFF. 2) Disconnect the connector from ABSCM&H/U. 3) Measure the resistance between ABSCM&H/U connector terminals. <b>Connector &amp; terminal</b> <b>(B301) No. 6 — No. 28:</b>	Is the resistance 5.0 — 5.6 kΩ?	Go to step 5.	Repair the harness/connector between G sensor and ABSCM&H/U.
<b>5</b>	<b>CHECK GROUND SHORT IN G SENSOR OUTPUT HARNESS.</b> 1) Disconnect the connector from G sensor. 2) Measure the resistance between ABSCM&H/U connector and chassis ground. <b>Connector &amp; terminal</b> <b>(B301) No. 6 — Chassis ground:</b>	Is the resistance more than 1 MΩ?	Go to step 6.	Repair the harness between G sensor and ABSCM&H/U.
<b>6</b>	<b>CHECK BATTERY SHORT OF HARNESS.</b> Measure the voltage between ABSCM&H/U connector and chassis ground. <b>Connector &amp; terminal</b> <b>(B301) No. 6 (+) — Chassis ground (-):</b>	Is the voltage less than 1 V?	Go to step 7.	Repair the harness between G sensor and ABSCM&H/U.
<b>7</b>	<b>CHECK BATTERY SHORT OF HARNESS.</b> 1) Turn the ignition switch to ON. 2) Measure the voltage between ABSCM&H/U connector and chassis ground. <b>Connector &amp; terminal</b> <b>(B301) No. 6 (+) — Chassis ground (-):</b>	Is the voltage less than 1 V?	Go to step 8.	Repair the harness between G sensor and ABSCM&H/U.
<b>8</b>	<b>CHECK GROUND SHORT OF HARNESS.</b> Measure the resistance between ABSCM&H/U connector and chassis ground. <b>Connector &amp; terminal</b> <b>(B301) No. 28 — Chassis ground:</b>	Is the resistance more than 1 MΩ?	Go to step 9.	Repair the harness between G sensor and ABSCM&H/U. Replace the ABSCM&H/U. <Ref. to ABS-6, ABS Control Module and Hydraulic Control Unit (ABSCM&H/U).>

# DIAGNOSTICS PROCEDURE WITHOUT SUBARU SELECT MONITOR

ABS (DIAGNOSTICS)

Step	Check	Yes	No
<b>9 CHECK G SENSOR.</b> 1)Turn the ignition switch to OFF. 2)Remove the G sensor from vehicle. 3)Connect the connector to G sensor. 4)Connect the connector to ABSCM&H/U. 5)Turn the ignition switch to ON. 6)Measure the voltage between G sensor connector terminals. <i><b>Connector &amp; terminal</b></i> <i><b>(B292) No. 2 (+) — No. 3 (-):</b></i>	Is the voltage 2.1 — 2.4 V when G sensor is horizontal?	Go to step 10.	Replace the G sensor. <Ref. to ABS-20, G Sensor.>
<b>10 CHECK G SENSOR.</b> Measure the voltage between G sensor connector terminals. <i><b>Connector &amp; terminal</b></i> <i><b>(B292) No. 2 (+) — No. 3 (-):</b></i>	Is the voltage 3.7 — 4.1 V when G sensor is inclined forwards to 90°?	Go to step 11.	Replace the G sensor. <Ref. to ABS-20, G Sensor.>
<b>11 CHECK G SENSOR.</b> Measure the voltage between G sensor connector terminals. <i><b>Connector &amp; terminal</b></i> <i><b>(B292) No. 2 (+) — No. 3 (-):</b></i>	Is the voltage 0.5 — 0.9 V when G sensor is inclined backwards to 90°?	Go to step 12.	Replace the G sensor. <Ref. to ABS-20, G Sensor.>
<b>12 CHECK POOR CONTACT IN CONNECTORS.</b>	Is there poor contact in connector between ABSCM&H/U and G sensor?	Repair the connector.	Go to step 13.
<b>13 CHECK ABSCM&amp;H/U.</b> 1)Connect all connectors. 2)Erase the memory. 3)Perform inspection mode. 4)Read out the DTC.	Is the same DTC as in the current diagnosis still being output?	Replace the ABSCM&H/U. <Ref. to ABS-6, ABS Control Module and Hydraulic Control Unit (ABSCM&H/U).>	Go to step 14.
<b>14 CHECK ANY OTHER DTC APPEARANCE.</b>	Are other DTCs being output?	Proceed with the diagnosis corresponding to DTC.	A temporary poor contact.



# DIAGNOSTICS PROCEDURE WITHOUT SUBARU SELECT MONITOR

ABS (DIAGNOSTICS)

## AC:DTC 73

### — ABNORMAL LATERAL G SENSOR OUTPUT VOLTAGE —

**DIAGNOSIS:**

- Faulty Lateral G sensor output voltage

**TROUBLE SYMPTOM:**

- ABS does not operate.

**WIRING DIAGRAM:**

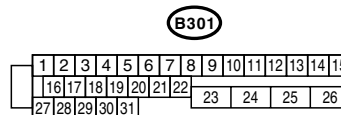
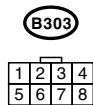
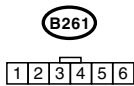
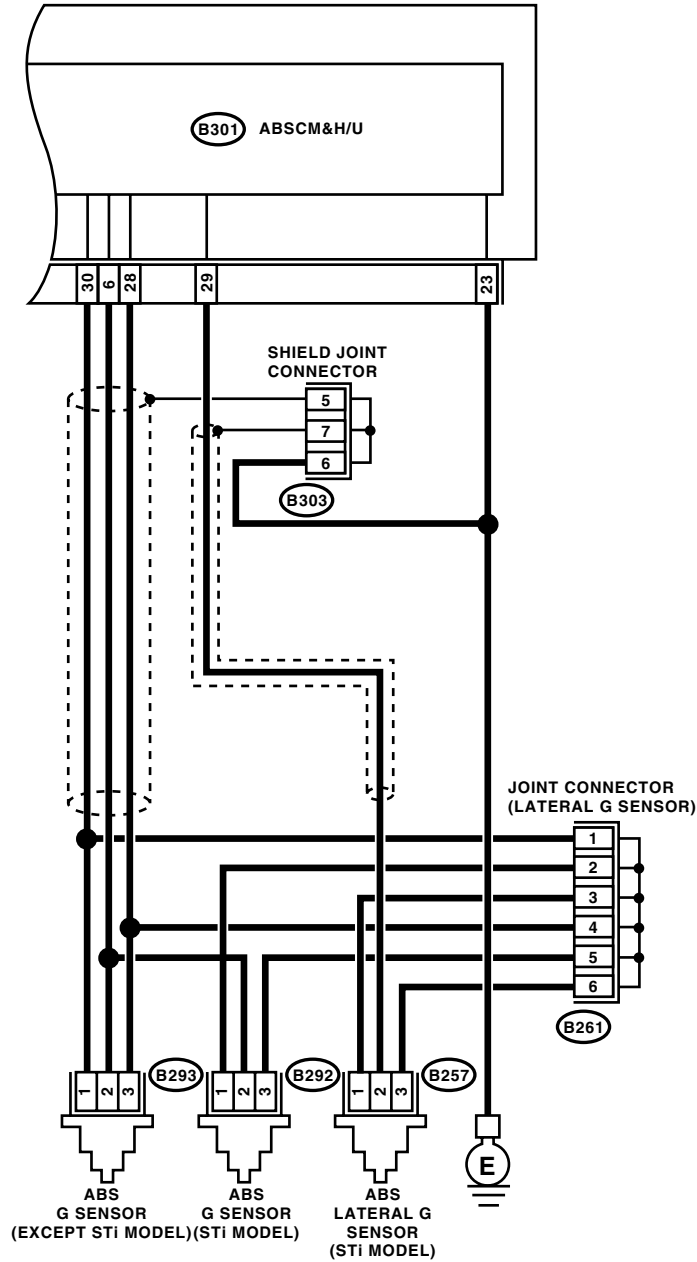

ABS00368

# DIAGNOSTICS PROCEDURE WITHOUT SUBARU SELECT MONITOR

ABS (DIAGNOSTICS)

Step	Check	Yes	No	
1	<b>CHECK ALL FOUR WHEELS FOR FREE TURNING.</b>	Have the wheels been turned freely such as when the vehicle is lifted up, or operated on a free roller or rolling road?	The ABS is normal. Erase the DTC.	Go to step 2.
2	<b>CHECK SPECIFICATIONS OF ABSCM&amp;H/U.</b> Check the specifications of mark on ABSCM&H/U. <b>CU: AT</b> <b>CV: MT (Except STi model)</b> <b>CY: MT (STi model)</b>	Does the vehicle specification and ABSCM&H/U specification match?	Go to step 3.	Replace the ABSCM&H/U. <Ref. to ABS-6, ABS Control Module and Hydraulic Control Unit (ABSCM&H/U).>
3	<b>CHECK INPUT VOLTAGE OF LATERAL G SENSOR.</b> 1)Turn the ignition switch to OFF. 2)Remove the console box. 3)Remove the lateral G sensor from vehicle. (Do not disconnect the connector.) 4)Turn the ignition switch to ON. 5)Measure the voltage between lateral G sensor connector terminals. <b>Connector &amp; terminal</b> <b>(B257) No. 1 (+) — No. 3 (-):</b>	Is the voltage 4.75 — 5.25 V?	Go to step 4.	Repair the harness/connector between lateral G sensor and ABSCM&H/U.
4	<b>CHECK OPEN CIRCUIT IN LATERAL G SENSOR OUTPUT HARNESS AND GROUND HARNESS.</b> 1)Turn the ignition switch to OFF. 2)Disconnect the connector from ABSCM&H/U. 3)Measure the resistance between ABSCM&H/U connector terminals. <b>Connector &amp; terminal</b> <b>(B301) No. 29 — No. 28:</b>	Is the resistance 5.0 — 5.6 kΩ?	Go to step 5.	Repair the harness/connector between lateral G sensor and ABSCM&H/U.
5	<b>CHECK GROUND SHORT IN LATERAL G SENSOR OUTPUT HARNESS.</b> 1)Disconnect the connector from lateral G sensor. 2)Measure the resistance between ABSCM&H/U connector and chassis ground. <b>Connector &amp; terminal</b> <b>(B301) No. 29 — Chassis ground:</b>	Is the resistance more than 1 MΩ?	Go to step 6.	Repair the harness between lateral G sensor and ABSCM&H/U.
6	<b>CHECK BATTERY SHORT OF HARNESS.</b> Measure the voltage between ABSCM&H/U connector and chassis ground. <b>Connector &amp; terminal</b> <b>(B301) No. 29 (+) — Chassis ground (-):</b>	Is the voltage less than 1 V?	Go to step 7.	Repair the harness between lateral G sensor and ABSCM&H/U.
7	<b>CHECK BATTERY SHORT OF HARNESS.</b> 1)Turn the ignition switch to ON. 2)Measure the voltage between ABSCM&H/U connector and chassis ground. <b>Connector &amp; terminal</b> <b>(B301) No. 29 (+) — Chassis ground (-):</b>	Is the voltage less than 1 V?	Go to step 8.	Repair the harness between lateral G sensor and ABSCM&H/U.

# DIAGNOSTICS PROCEDURE WITHOUT SUBARU SELECT MONITOR

## ABS (DIAGNOSTICS)

Step	Check	Yes	No
<b>8 CHECK GROUND SHORT OF HARNESS.</b> Measure the resistance between ABSCM&H/U connector and chassis ground. <b>Connector &amp; terminal</b> <b>(B301) No. 28 — Chassis ground:</b>	Is the resistance more than 1 MΩ?	Go to step 9.	Repair the harness between lateral G sensor and ABSCM&H/U. Replace the ABSCM&H/U. <Ref. to ABS-6, ABS Control Module and Hydraulic Control Unit (ABSCM&H/U).>
<b>9 CHECK LATERAL G SENSOR.</b> 1)Turn the ignition switch to OFF. 2)Remove the lateral G sensor from vehicle. 3)Connect the connector to lateral G sensor. 4)Connect the connector to ABSCM&H/U. 5)Turn the ignition switch to ON. 6)Measure the voltage between lateral G sensor connector terminals. <b>Connector &amp; terminal</b> <b>(B257) No. 2 (+) — No. 3 (-):</b>	Is the voltage 2.3 — 2.7 V when lateral G sensor is horizontal?	Go to step 10.	Replace the lateral G sensor. <Ref. to ABS-20, G Sensor.>
<b>10 CHECK LATERAL G SENSOR.</b> Measure the voltage between lateral G sensor connector terminals. <b>Connector &amp; terminal</b> <b>(B257) No. 2 (+) — No. 3 (-):</b>	Is the voltage between 3.7 — 4.1 V when lateral G sensor is inclined right to 90°?	Go to step 11.	Replace the lateral G sensor. <Ref. to ABS-20, G Sensor.>
<b>11 CHECK LATERAL G SENSOR.</b> Measure the voltage between lateral G sensor connector terminals. <b>Connector &amp; terminal</b> <b>(B257) No. 2 (+) — No. 3 (-):</b>	Is the voltage between 0.5 — 0.9 V when lateral G sensor is inclined left to 90°?	Go to step 12.	Replace the lateral G sensor. <Ref. to ABS-20, G Sensor.>
<b>12 CHECK POOR CONTACT IN CONNECTORS.</b>	Is there poor contact in connector between ABSCM&H/U and lateral G sensor?	Repair the connector.	Go to step 13.
<b>13 CHECK ABSCM&amp;H/U.</b> 1)Connect all connectors. 2)Erase the memory. 3)Perform inspection mode. 4)Read out the DTC.	Is the same DTC as in the current diagnosis still being output?	Replace the ABSCM&H/U. <Ref. to ABS-6, ABS Control Module and Hydraulic Control Unit (ABSCM&H/U).>	Go to step 14.
<b>14 CHECK ANY OTHER DTC APPEARANCE.</b>	Are other DTCs being output?	Proceed with the diagnosis corresponding to DTC.	A temporary poor contact.