

# AT CONTROL SYSTEM

## WIRING SYSTEM

### 8. AT Control System

#### A: SCHEMATIC

##### 1. TURBO MODEL

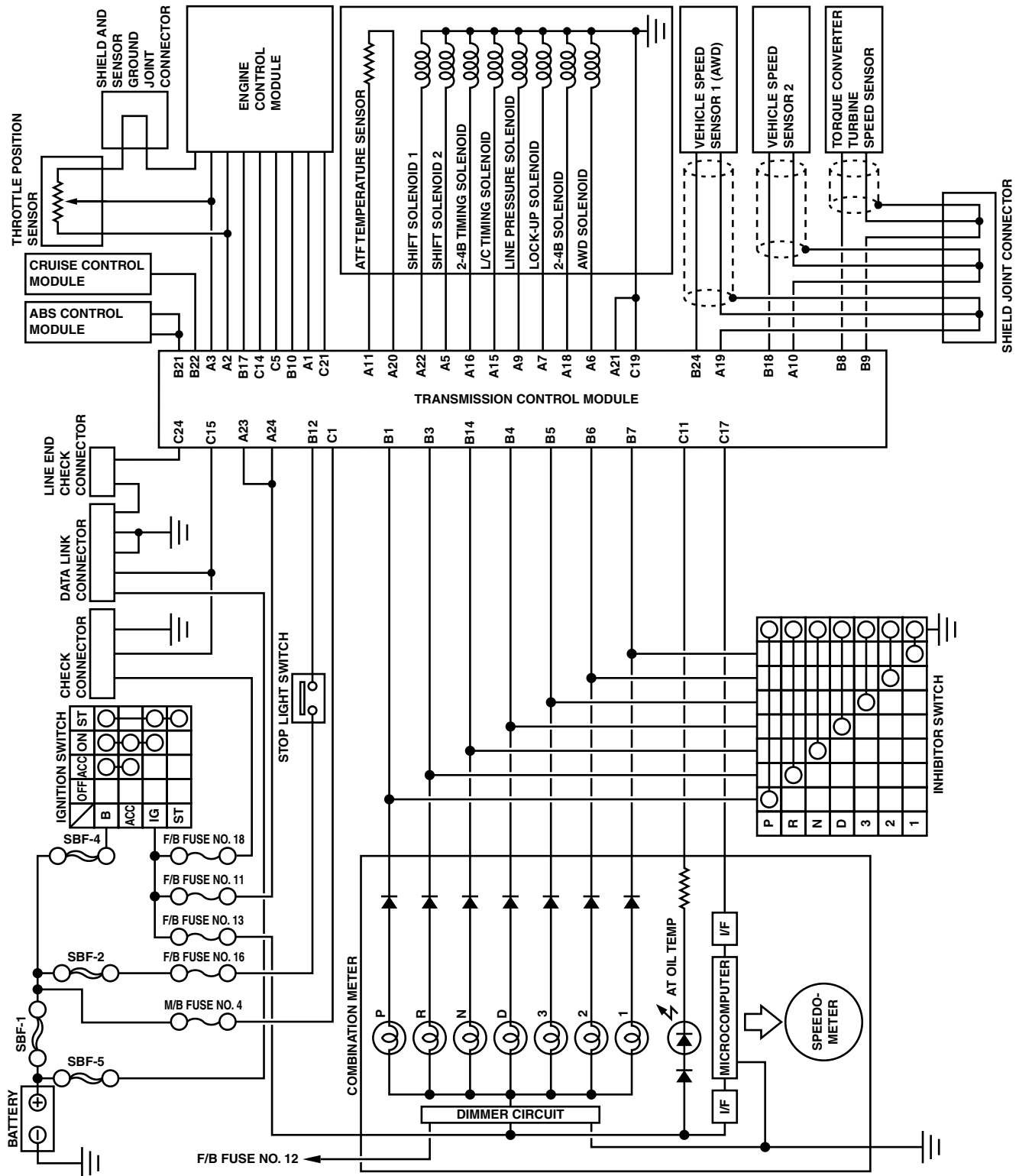

WI-02574

# AT CONTROL SYSTEM

WIRING SYSTEM

AT(TB)-01

AT(TB)-01

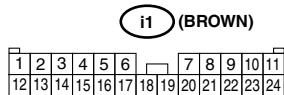
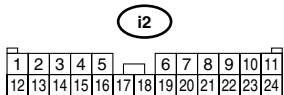
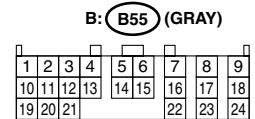
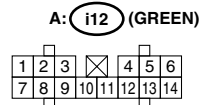
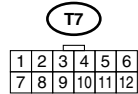
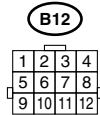
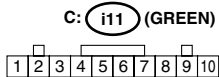
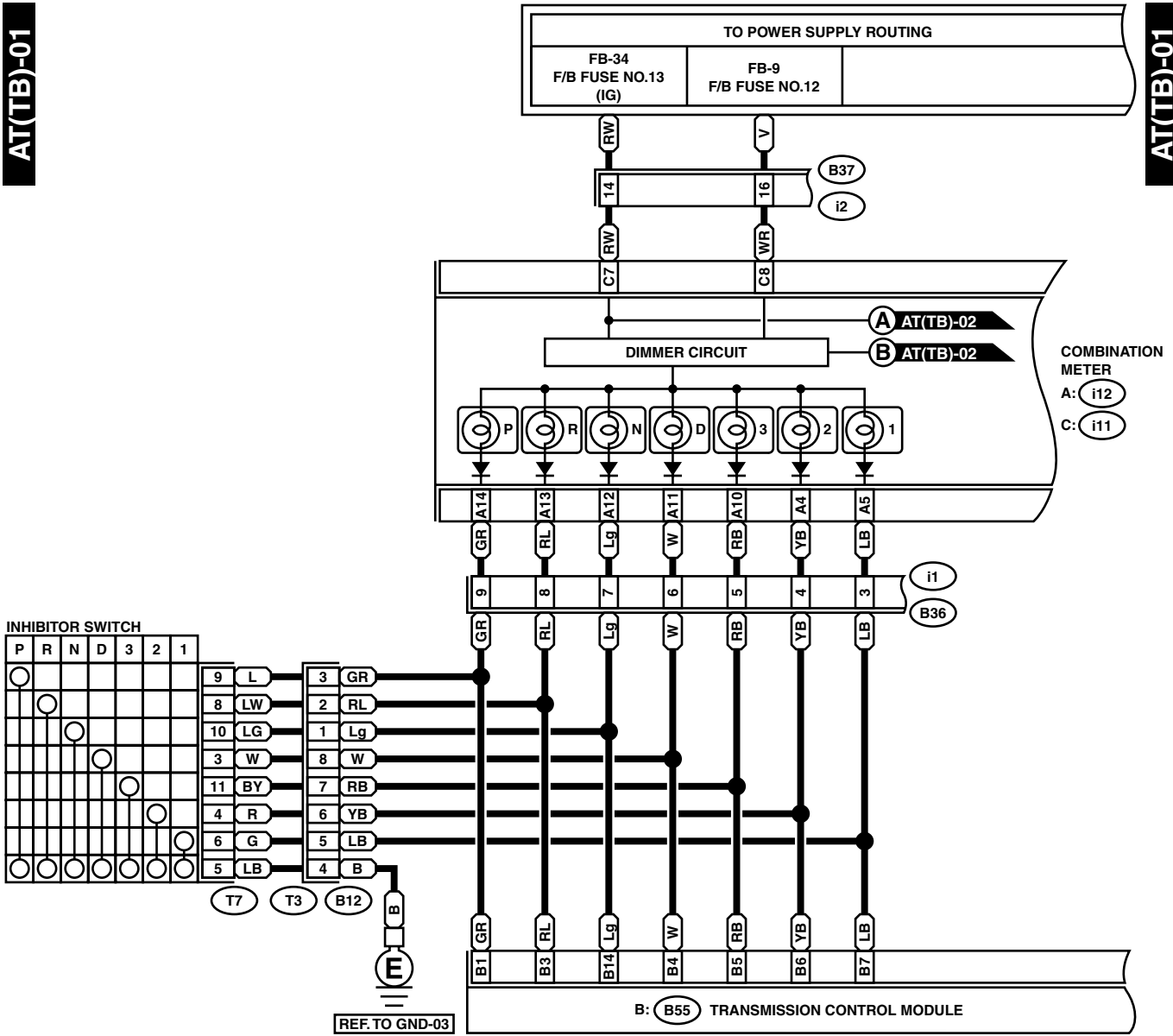

WI-02459

# AT CONTROL SYSTEM

WIRING SYSTEM

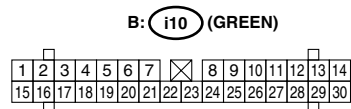
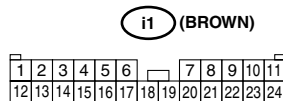
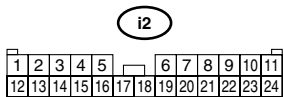
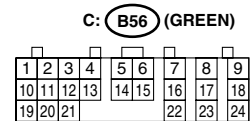
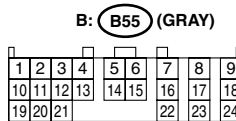
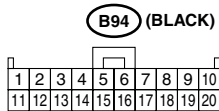
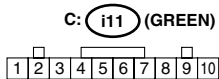
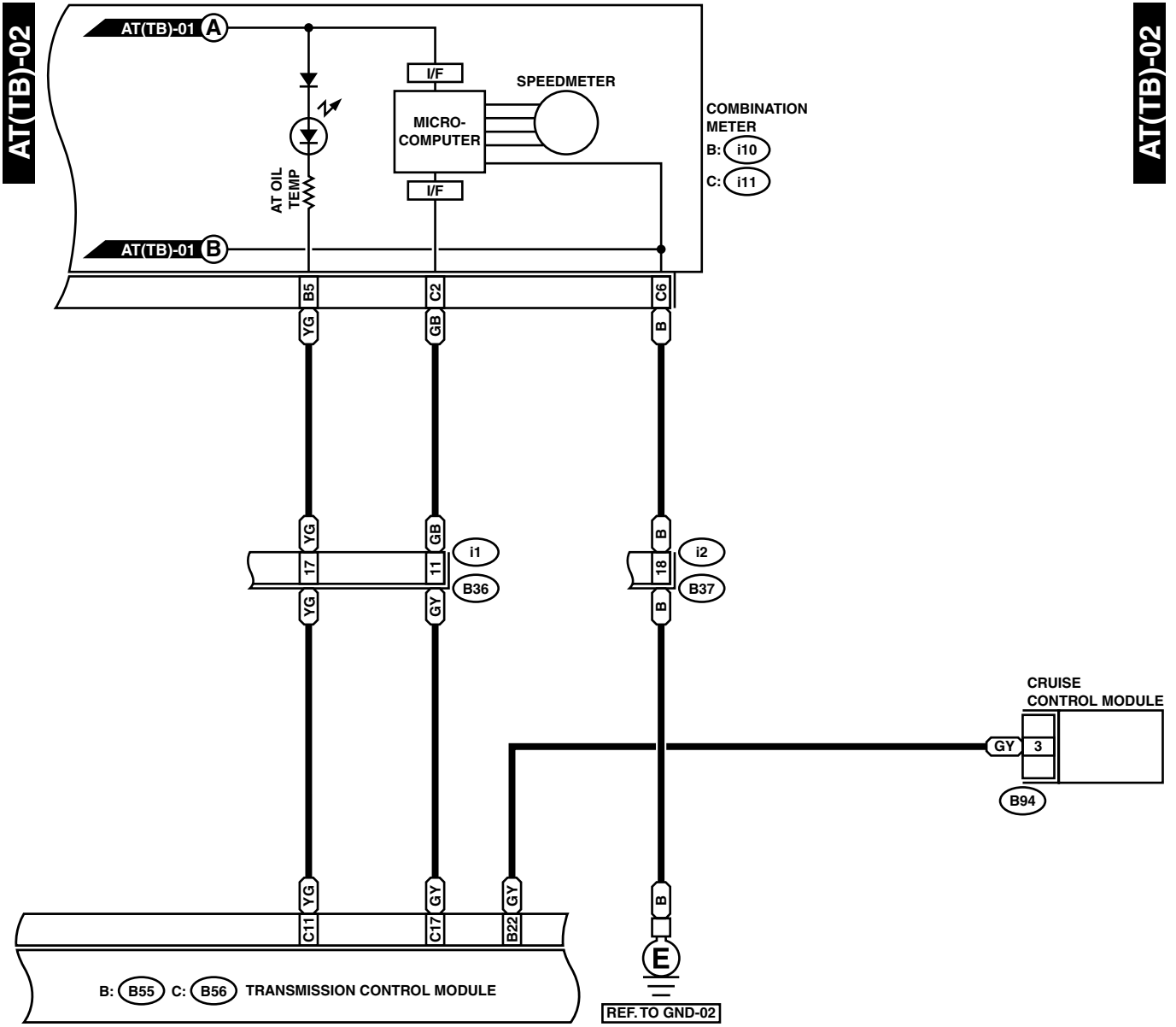

WI-02460

# AT CONTROL SYSTEM

## WIRING SYSTEM

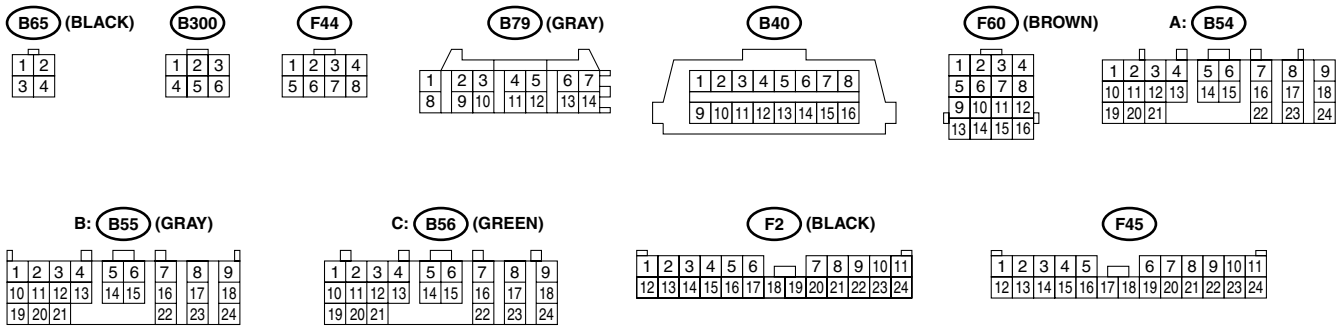
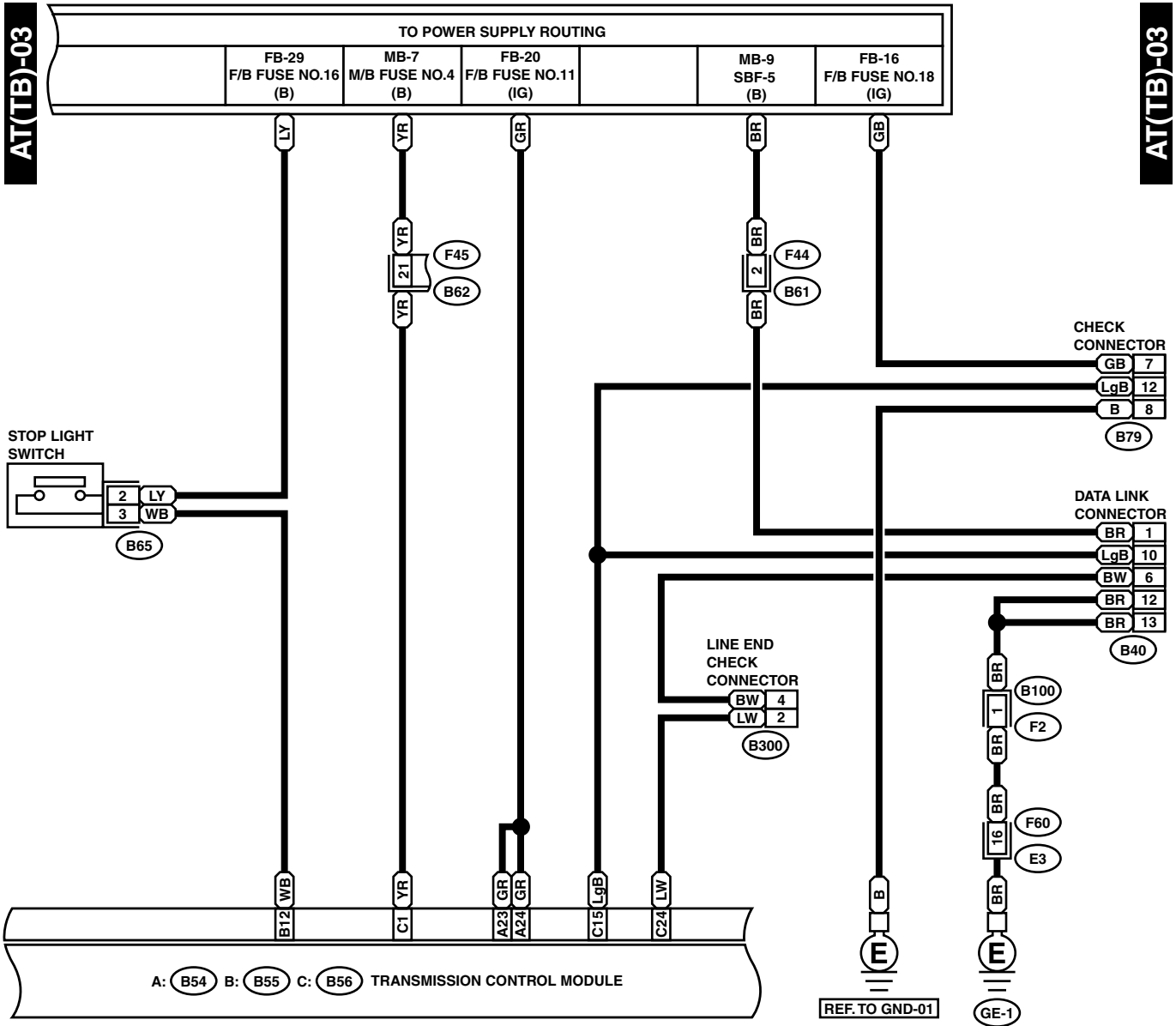

WI-02461

# AT CONTROL SYSTEM

## WIRING SYSTEM

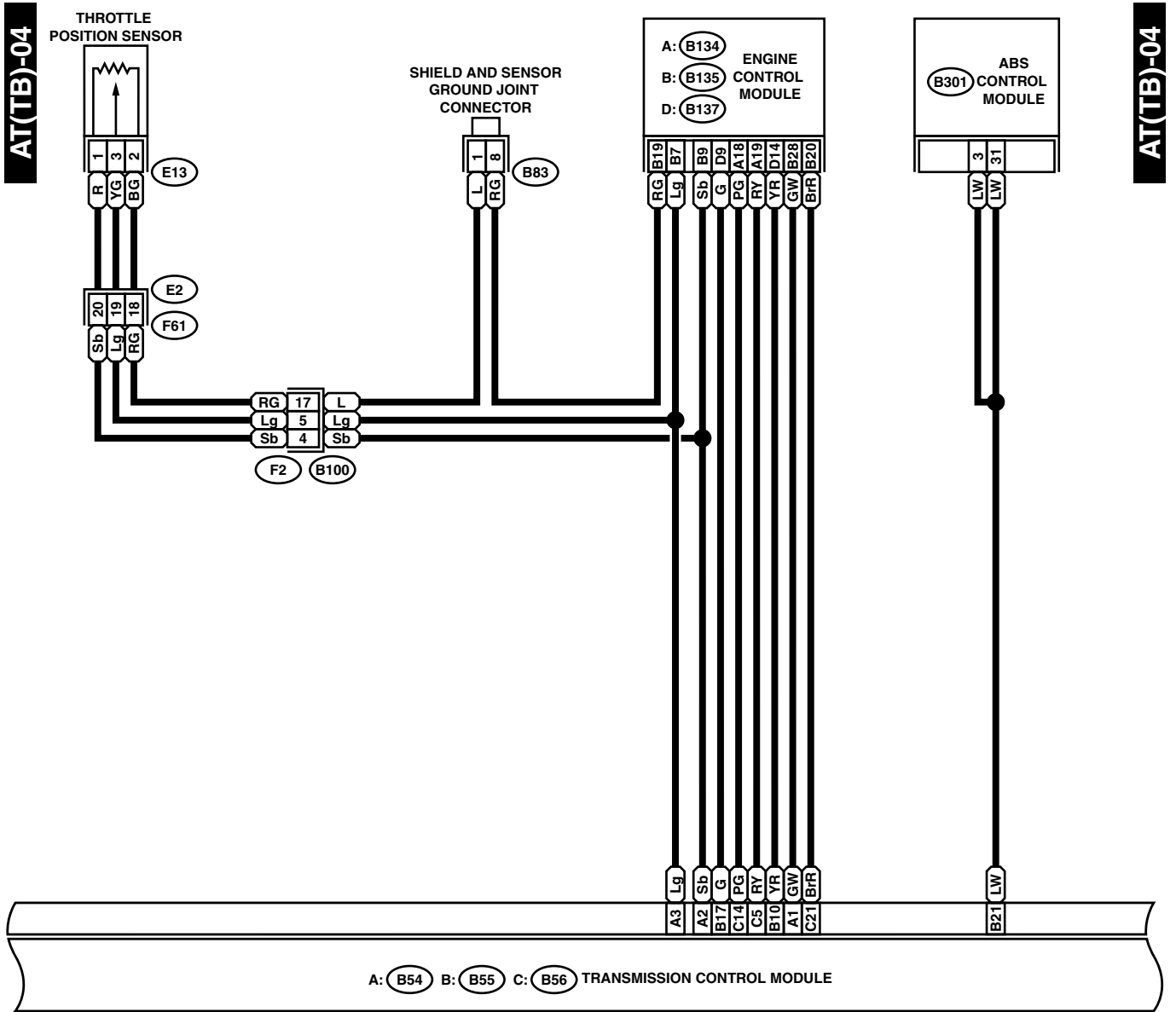

E13 (BLACK)

1	2	3
---	---	---

B83

1	2	3	4
5	6	7	8

F61 (BLACK)

1	2	3	4
5	6	7	8
9	10	11	12
13	14	15	16
17	18	19	20

A: (B134)

1	2	3	4	5	6	7	
8	9	10	11	12	13	14	15
16	17	18	19	20	21	22	

A: (B54)

1	2	3	4	5	6	7	8	9
10	11	12	13	14	15	16	17	18
19	20	21	22	23	24			

B: (B55) (GRAY)

1	2	3	4	5	6	7	8	9
10	11	12	13	14	15	16	17	18
19	20	21	22	23	24			

C: (B56) (GREEN)

1	2	3	4	5	6	7	8	9
10	11	12	13	14	15	16	17	18
19	20	21	22	23	24			

D: (B137)

1	2	3	4	5	6	7		
8	9	10	11	12	13	14	15	16
17	18	19	20	21	22	23	24	

F2 (BLACK)

1	2	3	4	5	6	7	8	9	10	11		
12	13	14	15	16	17	18	19	20	21	22	23	24

B: (B135)

1	2	3	4	5	6	7	8	9	
10	11	12	13	14	15	16	17	18	19
20	21	22	23	24	25	26	27	28	

B301

1	2	3	4	5	6	7	8	9	10	11	12	13	14	15
16	17	18	19	20	21	22	23	24	25	26				
27	28	29	30	31										

WI-02462

# AT CONTROL SYSTEM

WIRING SYSTEM

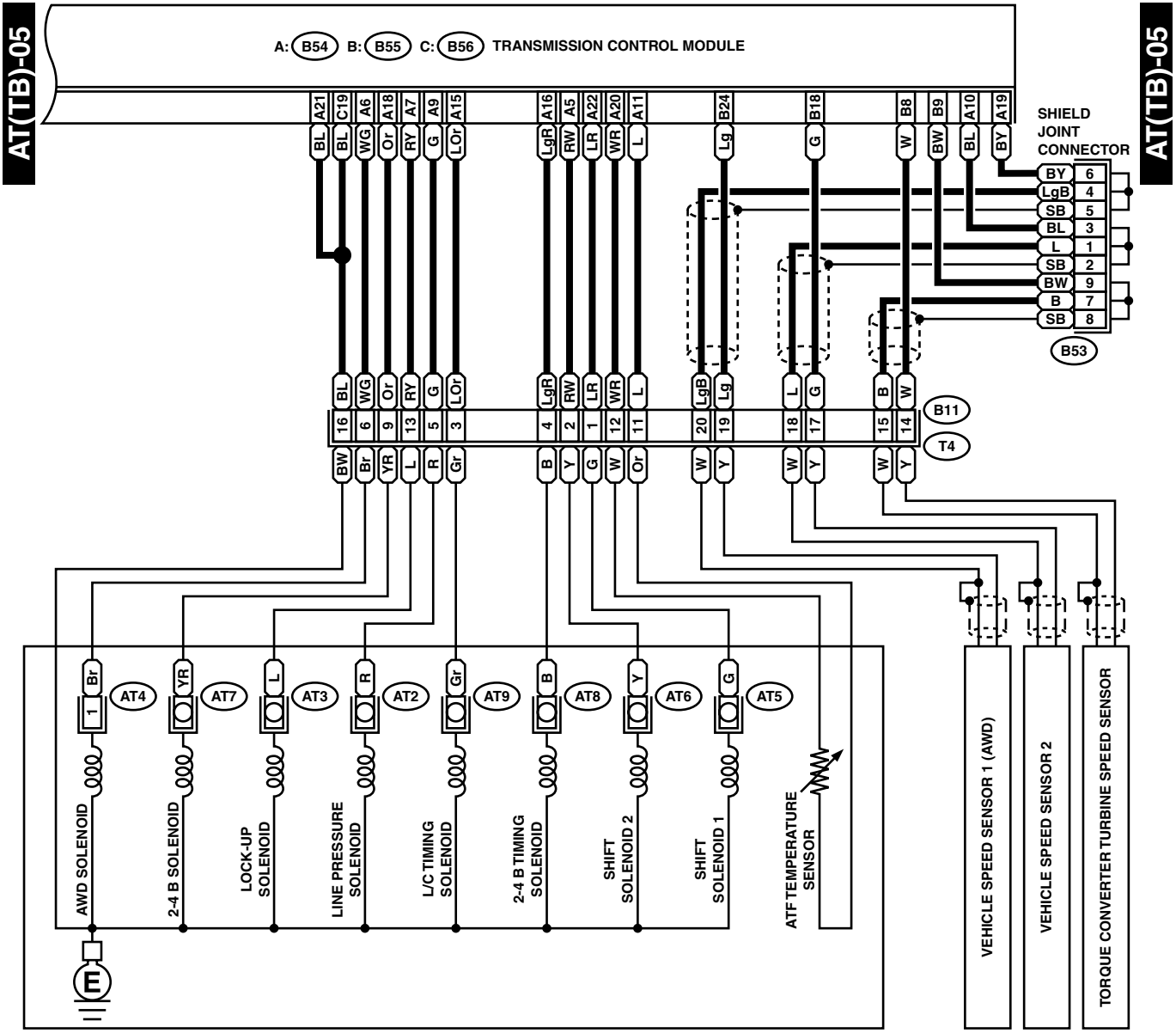

AT4 (BROWN)



B53 (BLACK)

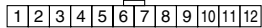

B11 (BLACK)

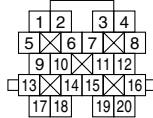

A: B54

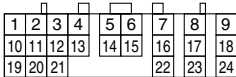

B: B55 (GRAY)

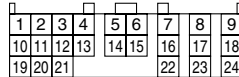

C: B56 (GREEN)

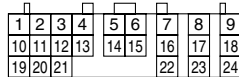

WI-02171

# AT CONTROL SYSTEM

## WIRING SYSTEM

### 2. NON-TURBO MODEL

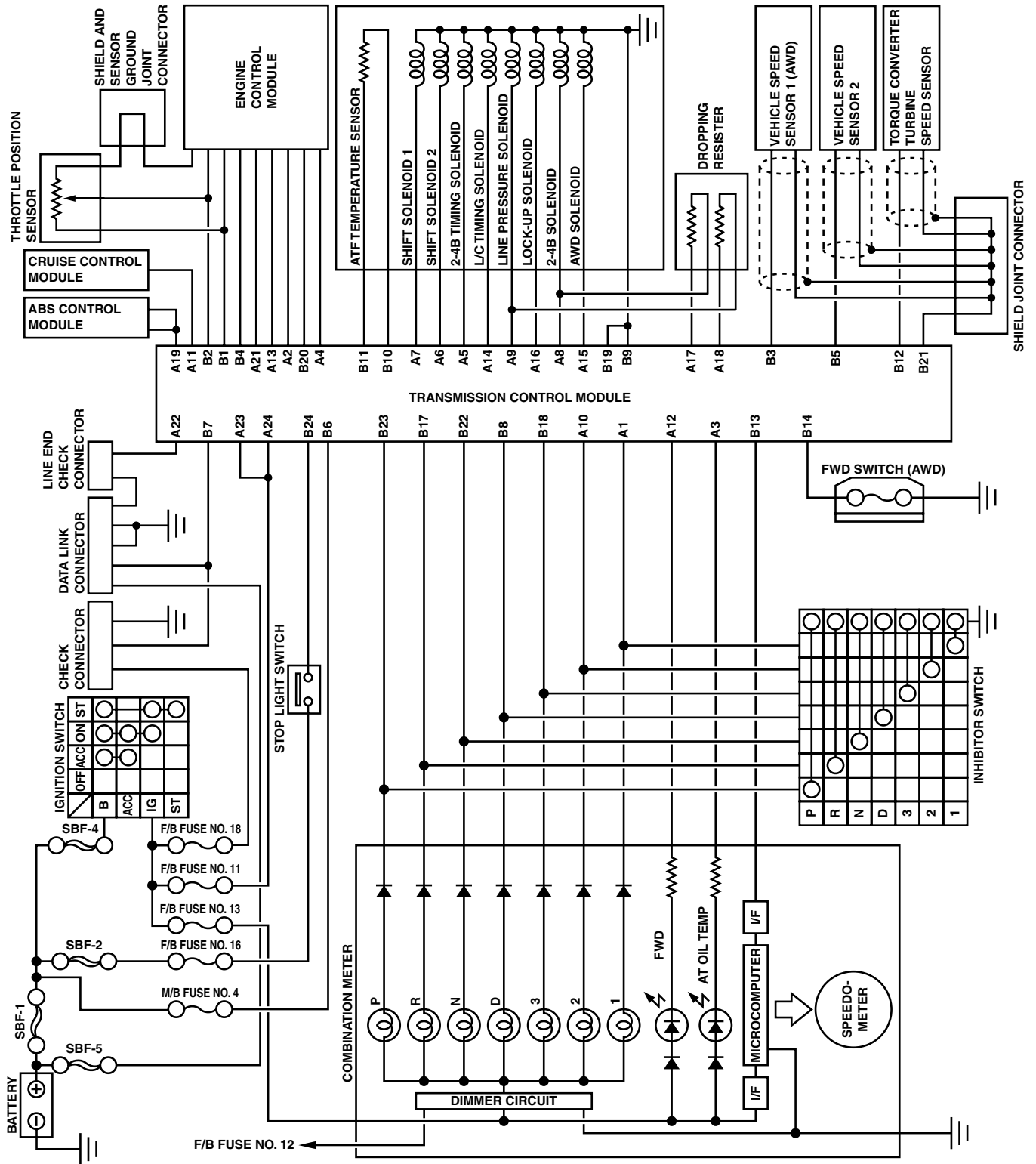

WI-02575

AT(NA)-01

AT(NA)-01

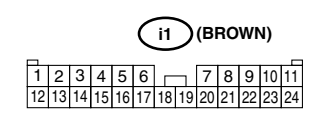
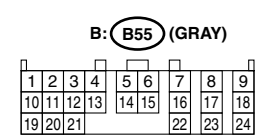
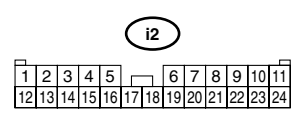
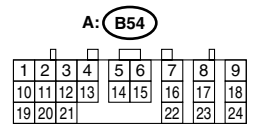
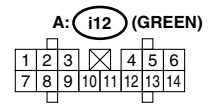
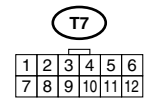
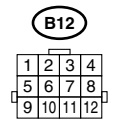
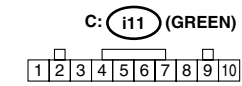
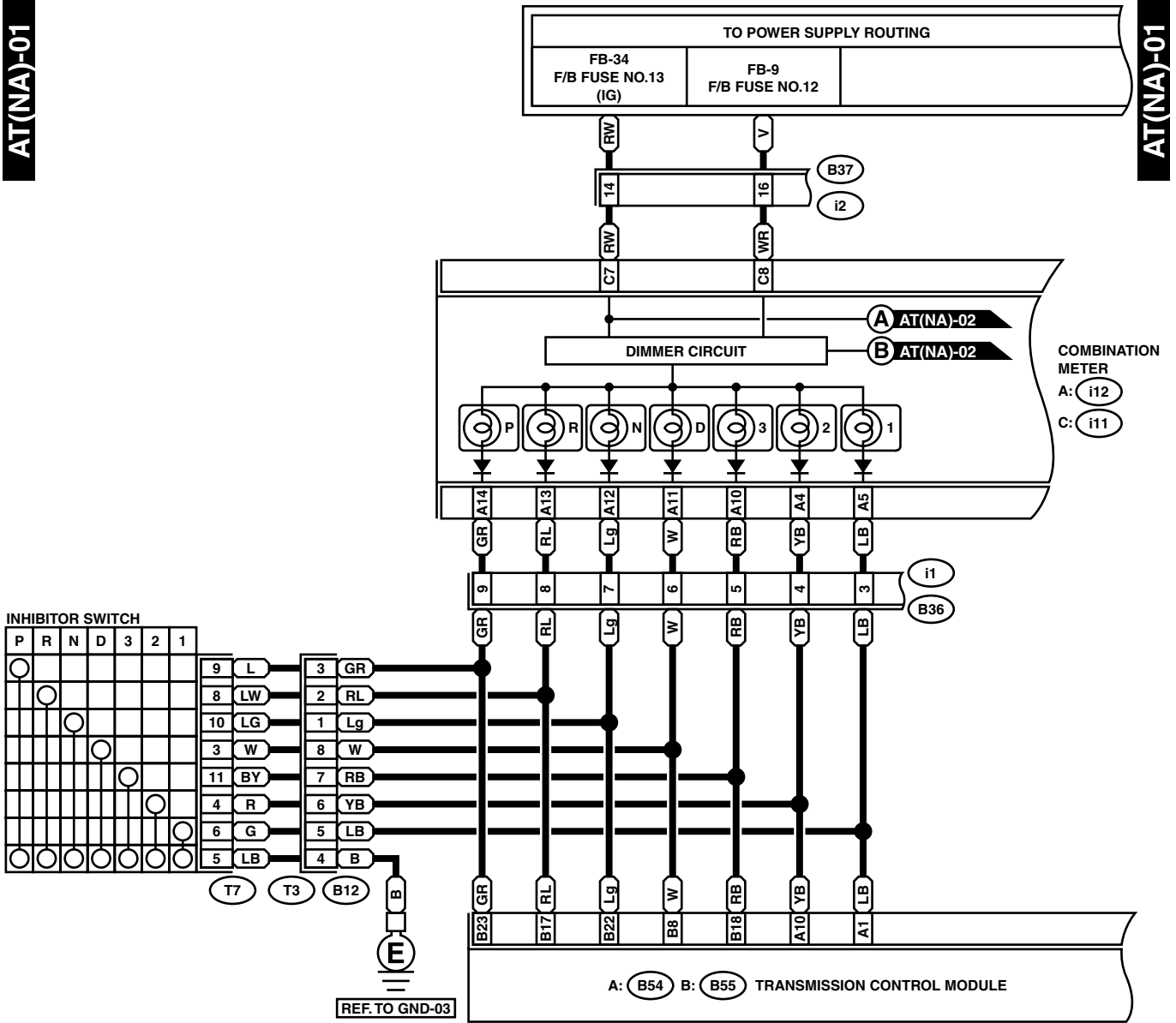



# AT CONTROL SYSTEM

## WIRING SYSTEM

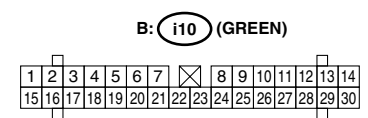
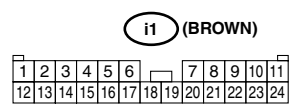
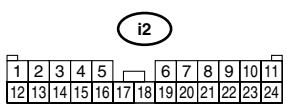
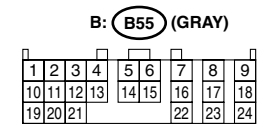
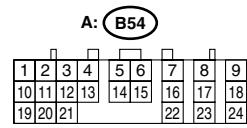
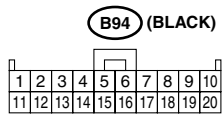
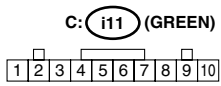
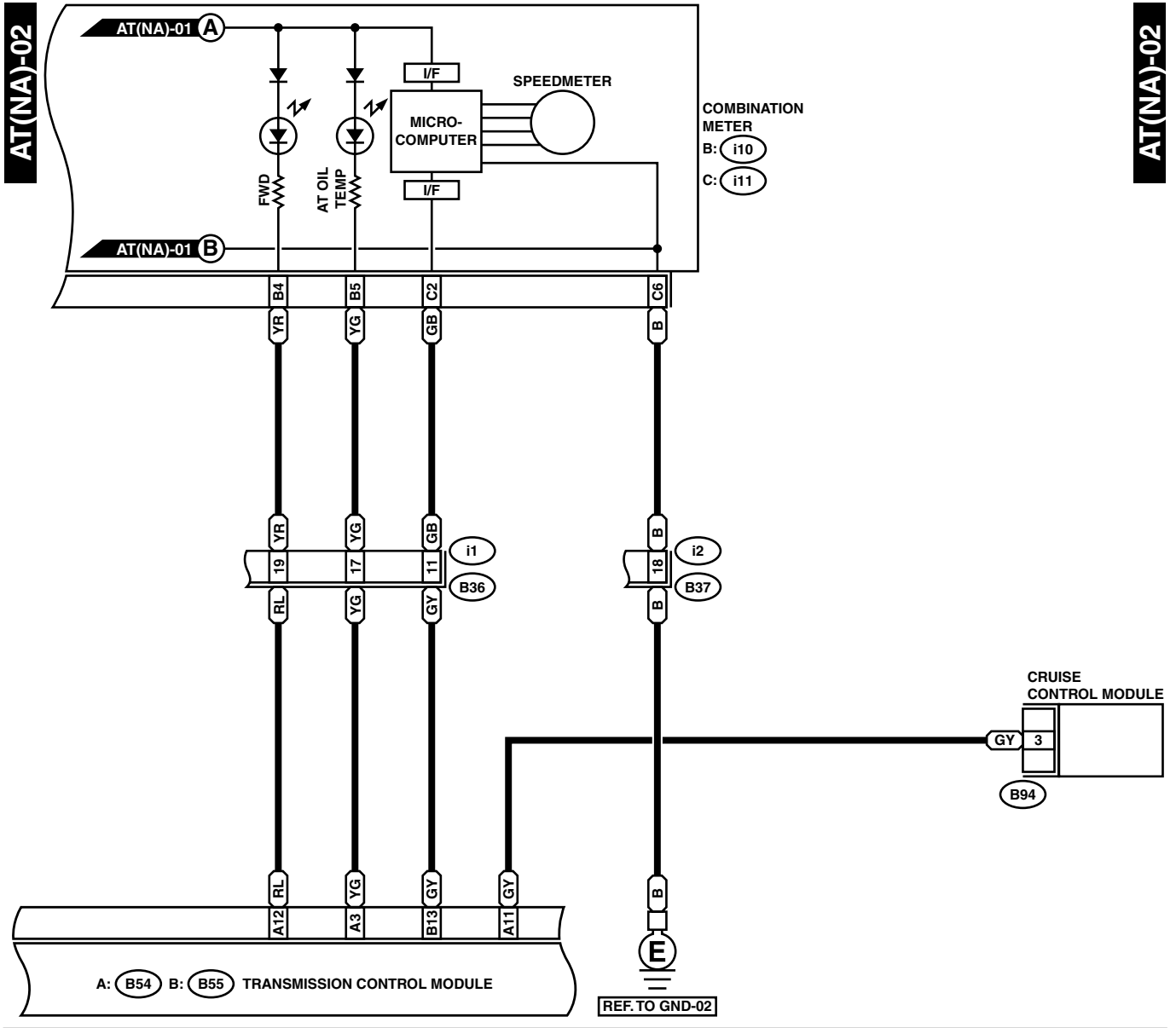

WI-02464

# AT CONTROL SYSTEM

WIRING SYSTEM

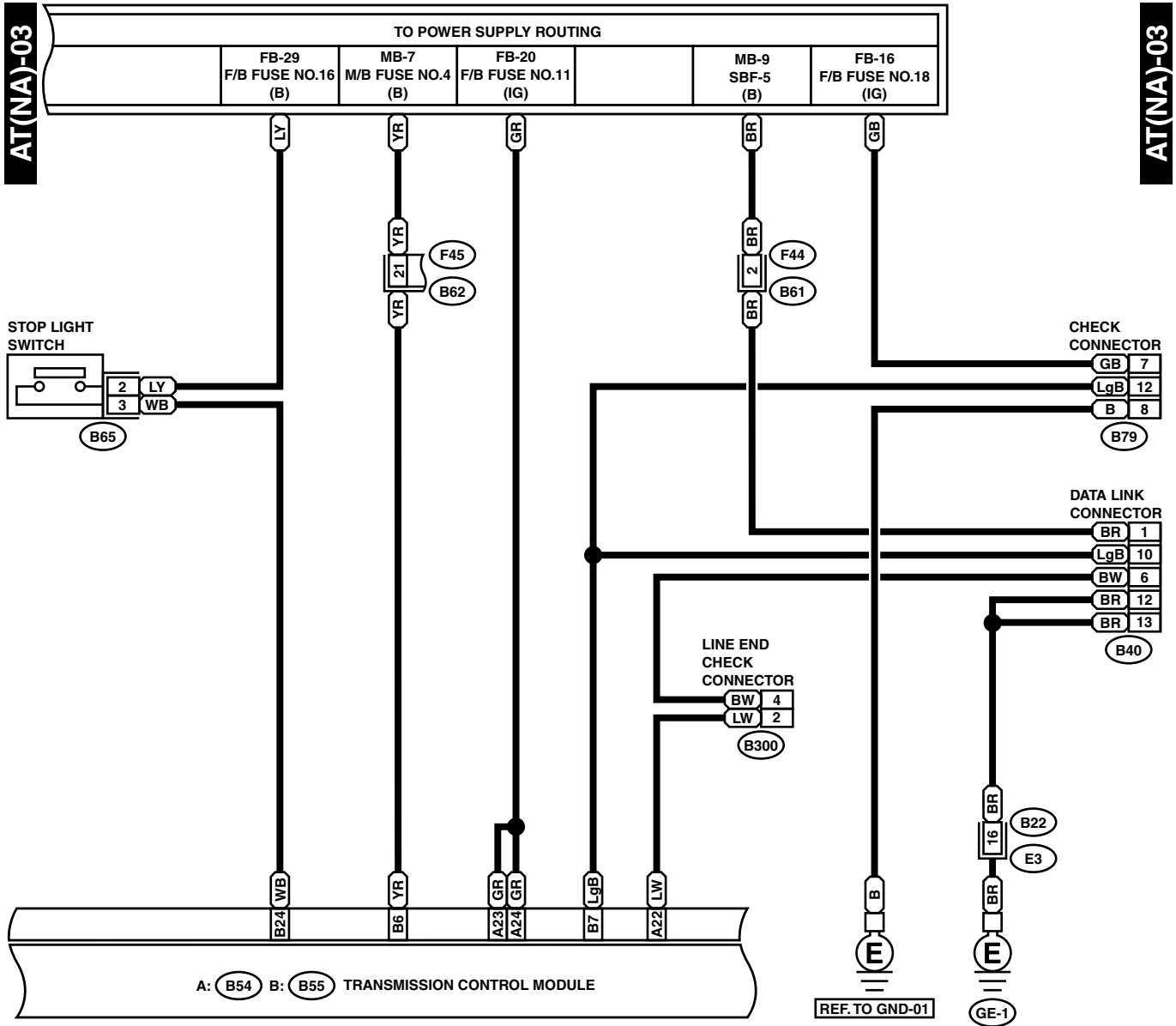

B65 (BLACK)



B300



F44



B79 (GRAY)

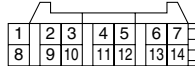

B22 (BROWN)

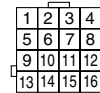

B40

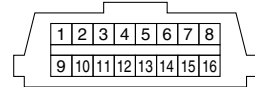

A: B54

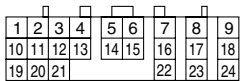

B: B55 (GRAY)

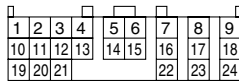

F45

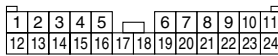

WI-02465

# AT CONTROL SYSTEM

## WIRING SYSTEM

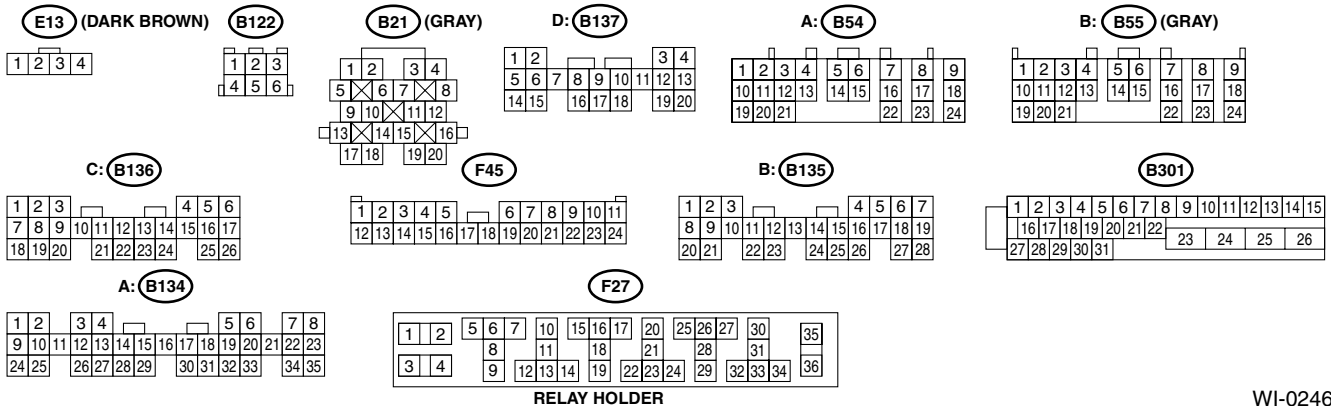
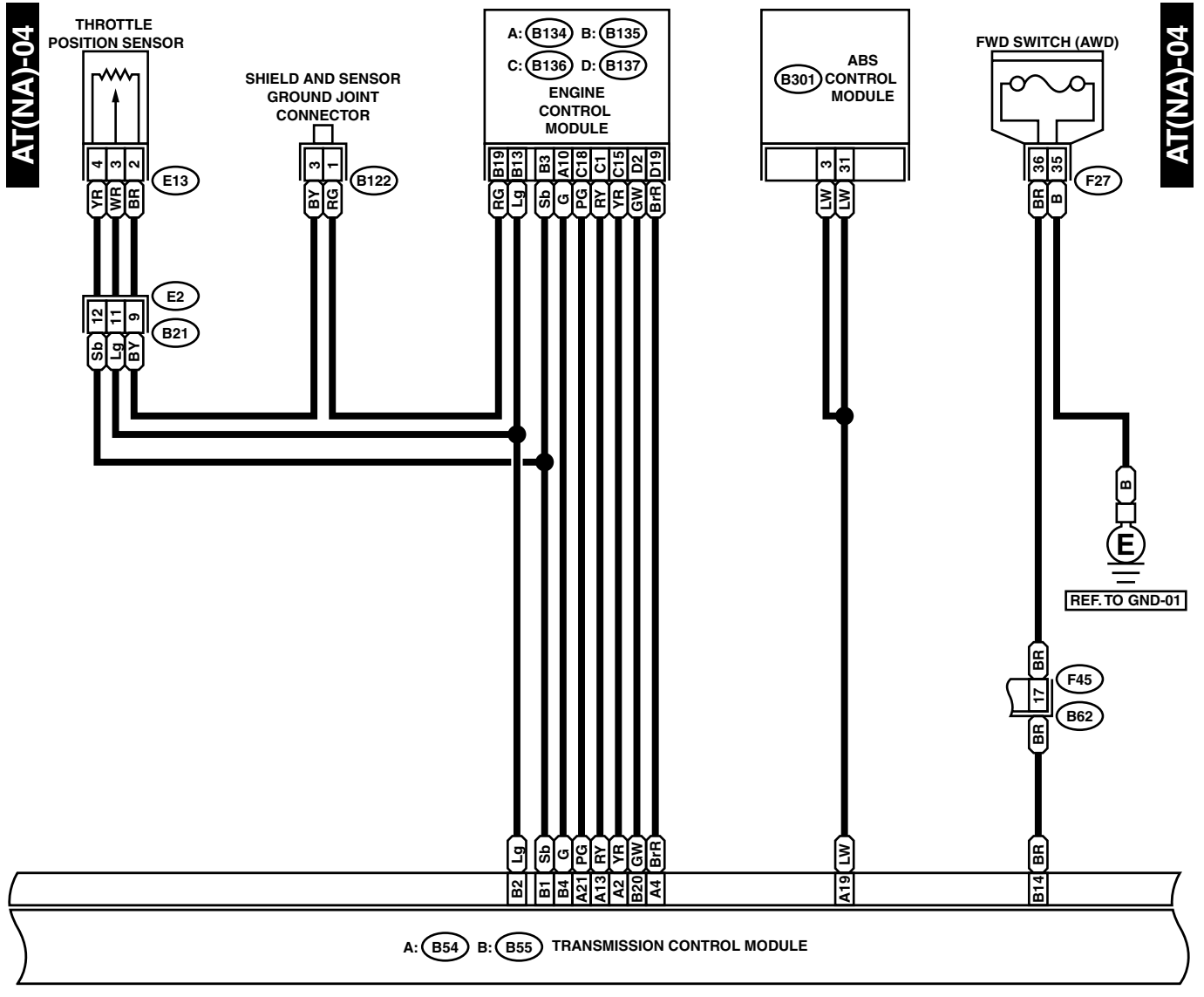

WI-02466

# AT CONTROL SYSTEM

WIRING SYSTEM

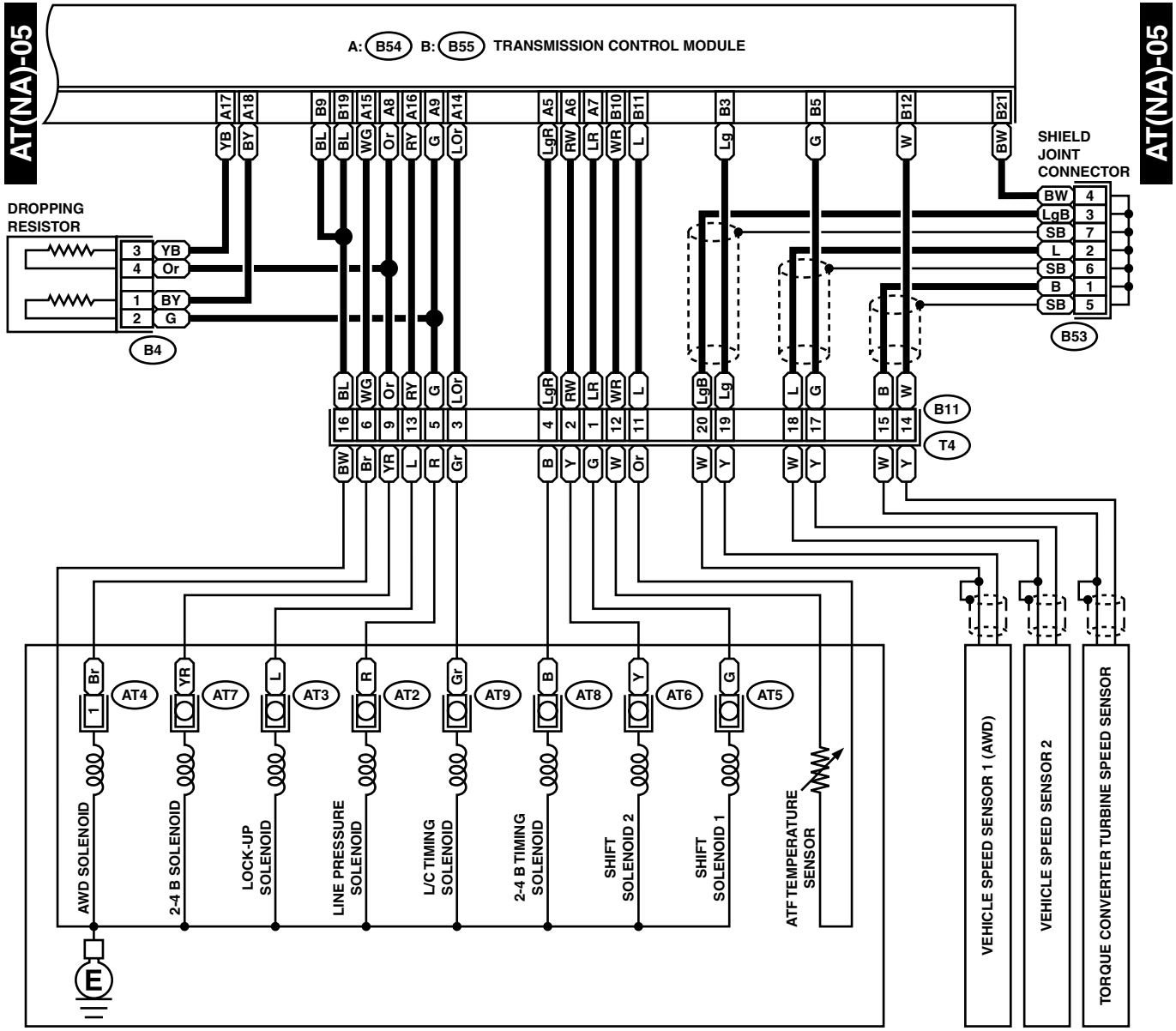

AT4 (BROWN)



B4 (GRAY)



B53

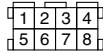

B11 (BLACK)

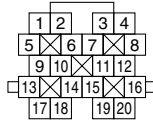

A: B54

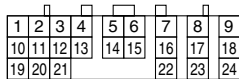

B: B55 (GRAY)

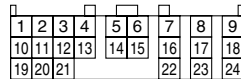

WI-01117