

## SEALER APPLICATION

### BODY STRUCTURE

---

#### 7. Sealer Application

##### A: ENGINE COMPARTMENT

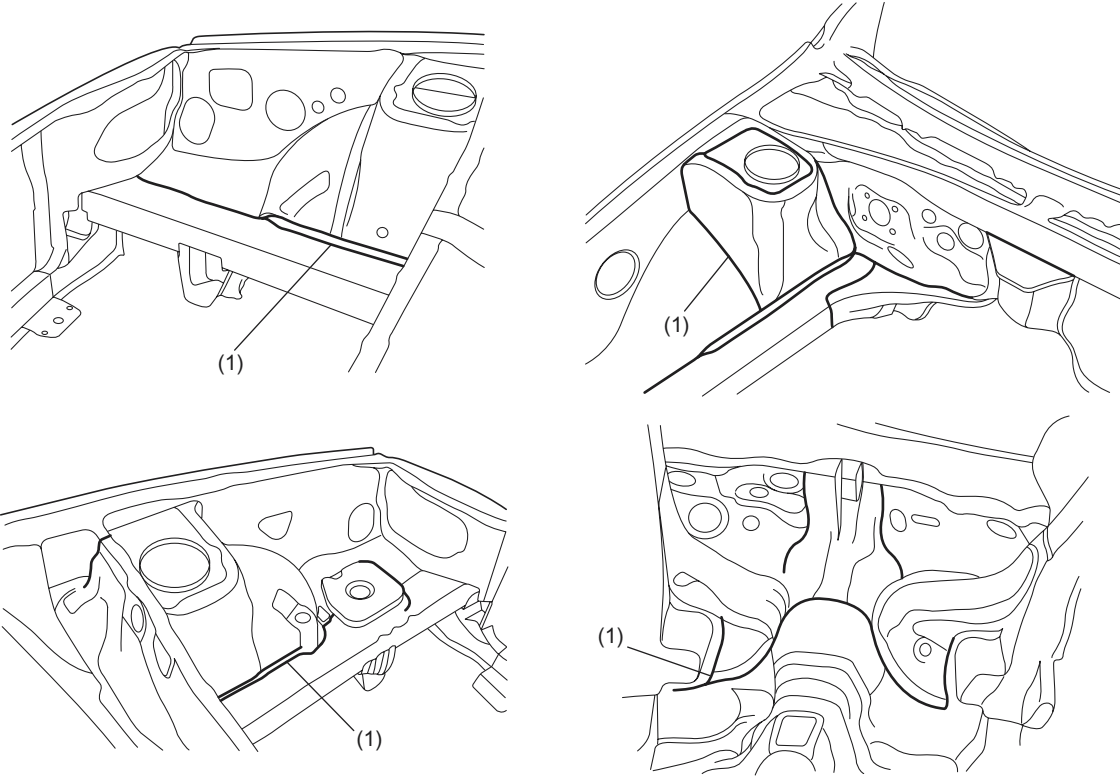

BS-00567

(1) Sealer

##### B: ENGINE HOOD

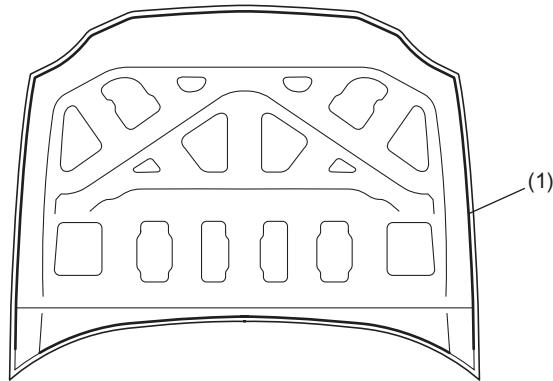

BS-00568

(1) Sealer

BS-10

# SEALER APPLICATION

BODY STRUCTURE

## C: DOOR

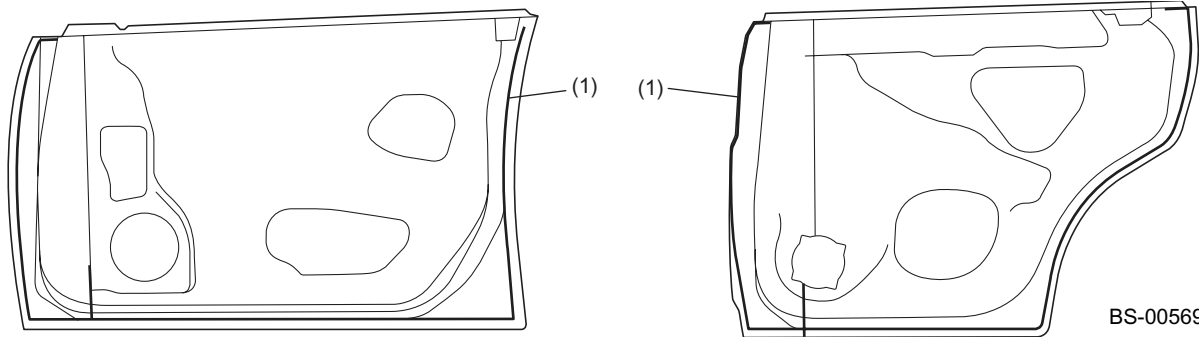

BS-00569

(1) Sealer

## D: REAR GATE

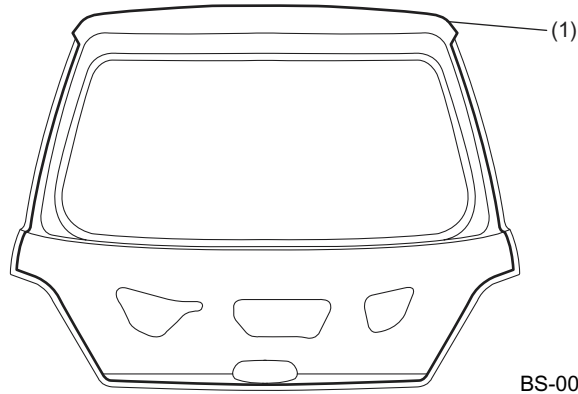

BS-00570

(1) Sealer

## E: TRUNK LID

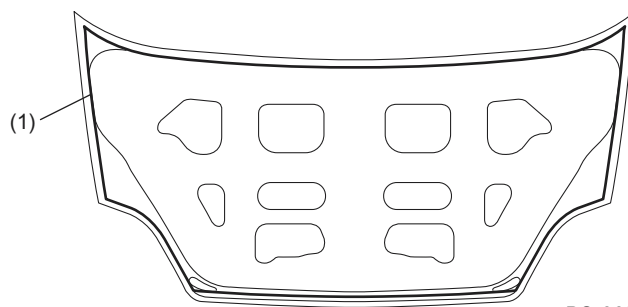

BS-00571

(1) Sealer

BS-11

## SEALER APPLICATION

### BODY STRUCTURE

---

### F: REAR END (WAGON)

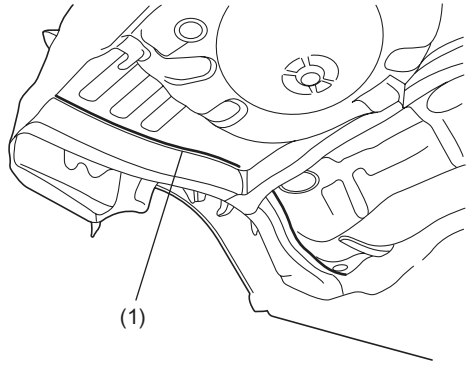
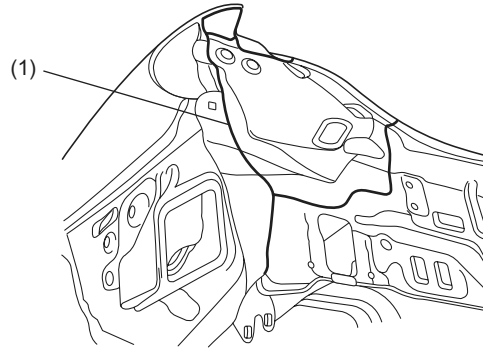
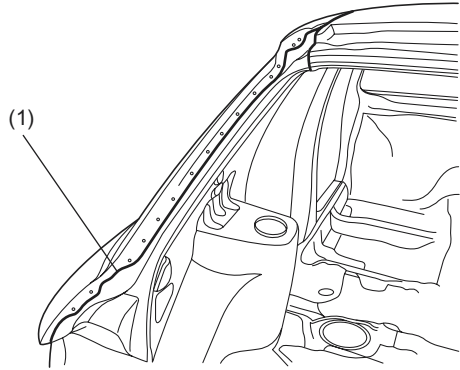

(1) Sealer

BS-00572

BS-12

## SEALER APPLICATION

BODY STRUCTURE

### G: REAR END (SEDAN)

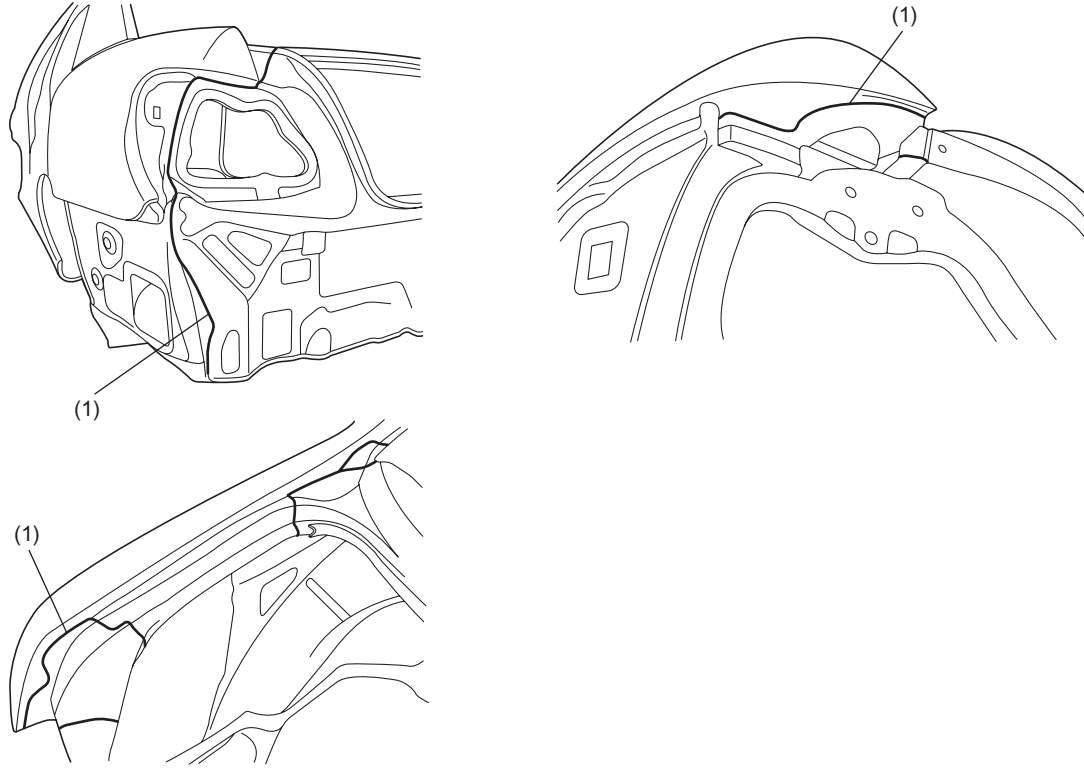

(1) Sealer

BS-00573

### H: ROOF PANEL

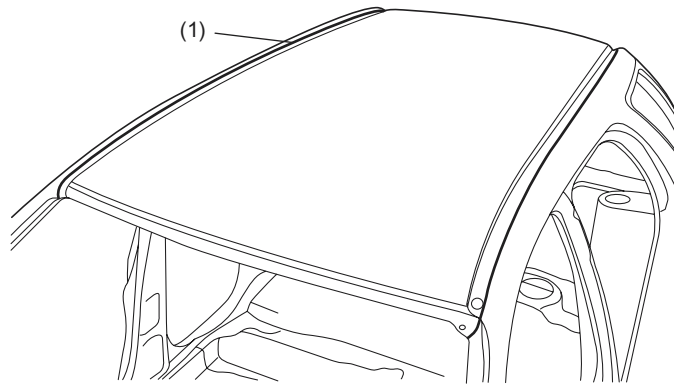

BS-00574

(1) Sealer

BS-13

## SEALER APPLICATION

### BODY STRUCTURE

---

#### I: FRONT FLOOR

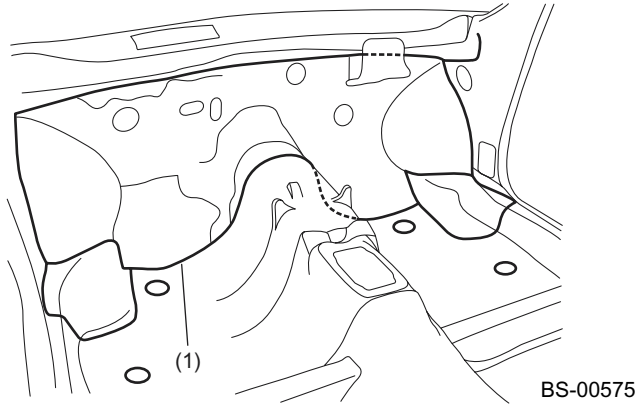

(1) Sealer

#### J: REAR FLOOR (WAGON)

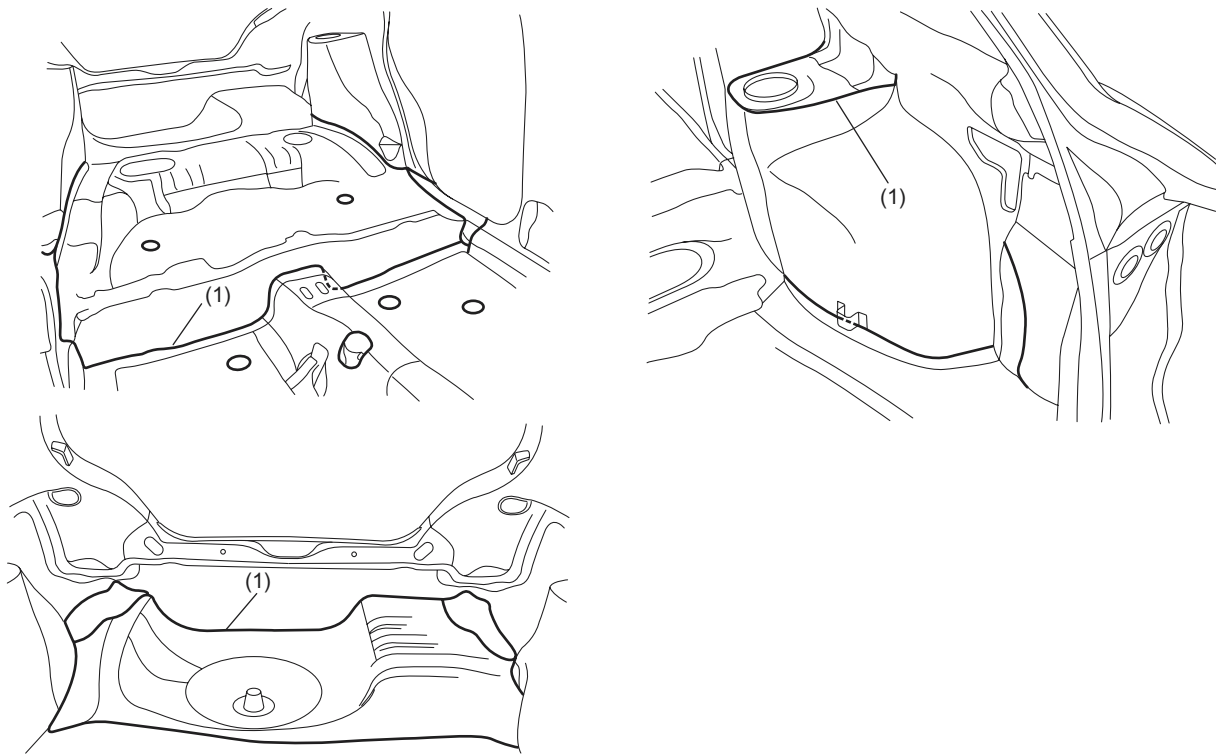

(1) Sealer

BS-14

## SEALER APPLICATION

BODY STRUCTURE

### K: REAR FLOOR (SEDAN)

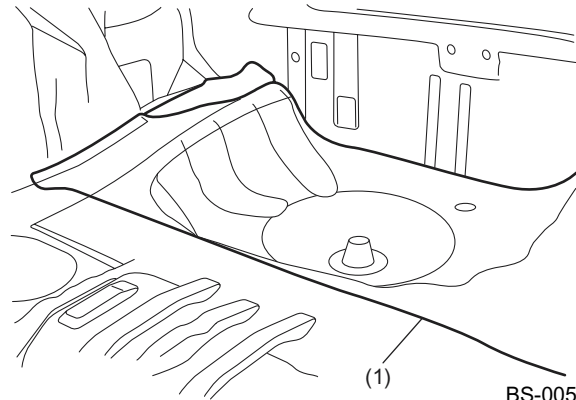
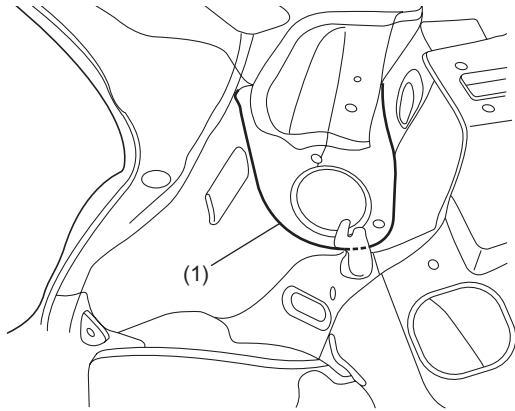

(1) Sealer

### L: UNDER BODY

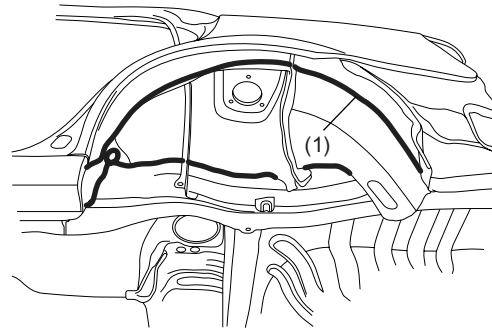
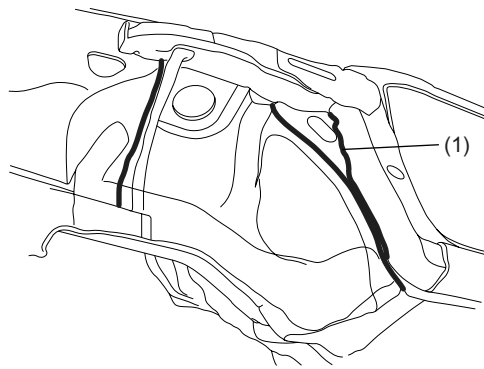

(1) Sealer

BS-00578

BS-15

## SEALER APPLICATION

### BODY STRUCTURE

---

#### M: FUEL LID (WAGON)

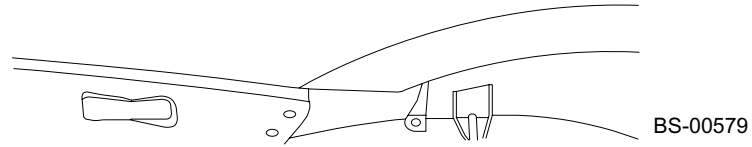
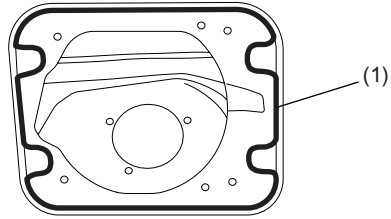

(1) Sealer

#### N: FUEL LID (SEDAN)

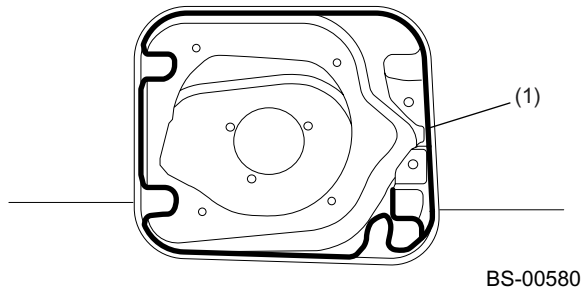

(1) Sealer

BS-16