

AIRBAG SYSTEM (DIAGNOSTICS)

Basic Diagnostic Procedure

AIRBAG SYSTEM (DIAGNOSTICS)

1. Basic Diagnostic Procedure

A: PROCEDURE

	Step	Check	Yes	No
1	CHECK AIRBAG WARNING LIGHT. Turn the ignition switch to ON.	Does the airbag warning light come on?	Go to step 2.	Go to "Airbag Warning Light Failure" <Ref. to AB(diag)-37, Airbag Warning Light Failure.>.
2	READ DTC. <Ref. to AB(diag)-34, Read Diagnostic Trouble Code (DTC).>	Is the normal code being detected?	Finish the diagnosis.	Go to step 3.
3	PERFORM THE DIAGNOSIS. 1) Judge the possible cause from "List of Diagnostic Trouble Code (DTC)". <Ref. to AB(diag)-45, List of Diagnostic Trouble Code (DTC).> 2) Inspect using "Diagnostic Chart with Diagnostic Trouble Code (DTC)". 3) Repair the cause of the trouble. 4) Perform the clear memory mode. <Ref. to AB(diag)-36, Clear Memory Mode.> 5) Perform the inspection mode. <Ref. to AB(diag)-35, Inspection Mode.> 6) Read any DTC again.	Is the DTC being detected?	Perform the procedure 1) to 5) in step 3.	Finish the diagnosis.

Check List for Interview

AIRBAG SYSTEM (DIAGNOSTICS)

2. Check List for Interview

A: CHECK

Customer's Name		Inspector's Name	
Date Vehicle Brought In	/ /	Registration No.	
Odometer Reading	km miles	VIN	
Date Problem Occurred	/ /	Registration Year	/ /
Weather	<input type="checkbox"/> Fine <input type="checkbox"/> Cloudy <input type="checkbox"/> Rainy <input type="checkbox"/> Snowy <input type="checkbox"/> Other:		
Temperature	°C (°F)		
Road Condition	<input type="checkbox"/> Level road <input type="checkbox"/> Uphill <input type="checkbox"/> Downhill <input type="checkbox"/> Rough road <input type="checkbox"/> Others:		
Vehicle Operation	<input type="checkbox"/> Starting <input type="checkbox"/> Idling <input type="checkbox"/> Driving (<input type="checkbox"/> Constant Speed <input type="checkbox"/> Acceleration <input type="checkbox"/> Deceleration <input type="checkbox"/> Steering wheel turn <input type="checkbox"/> Other:)		
Details of Problem			
Check Airbag Warning Light	<input type="checkbox"/> Remains ON <input type="checkbox"/> Remains OFF		
Check DTC	<input type="checkbox"/> Normal Code <input type="checkbox"/> DTC: (Code)		

General Description

AIRBAG SYSTEM (DIAGNOSTICS)

3. General Description

A: CAUTION

- When servicing a vehicle, be sure to turn the ignition switch to OFF, disconnect the ground cable from battery, and wait for more than 20 seconds before starting work.
- The airbag system is fitted with a backup power source. If the airbag system is serviced within 20 seconds after the ground cable is disconnected, it may inflate.
- If sensors, airbag module, airbag control module, pretensioner, and harness are deformed or damaged, replace them with new genuine parts.

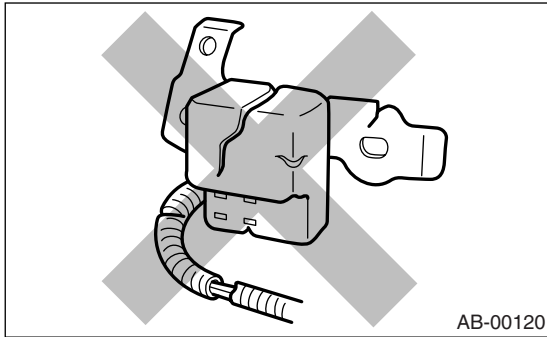

- Do not use the airbag system and pretensioners on other vehicles. When replacing parts, be sure to replace them with new parts.
- When checking the airbag system, be sure to use a digital circuit tester. Use of an analog circuit tester may cause the airbag to activate erroneously.

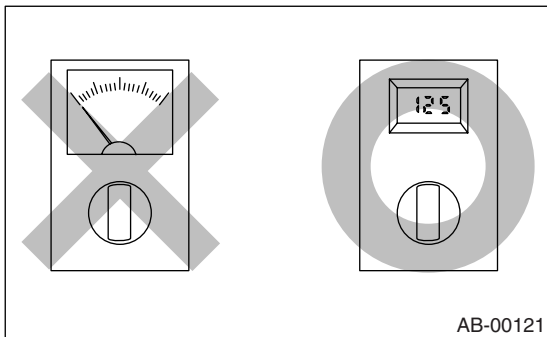

- When checking, use a test harness. Do not directly apply the tester probe to any connector terminal of the airbag.

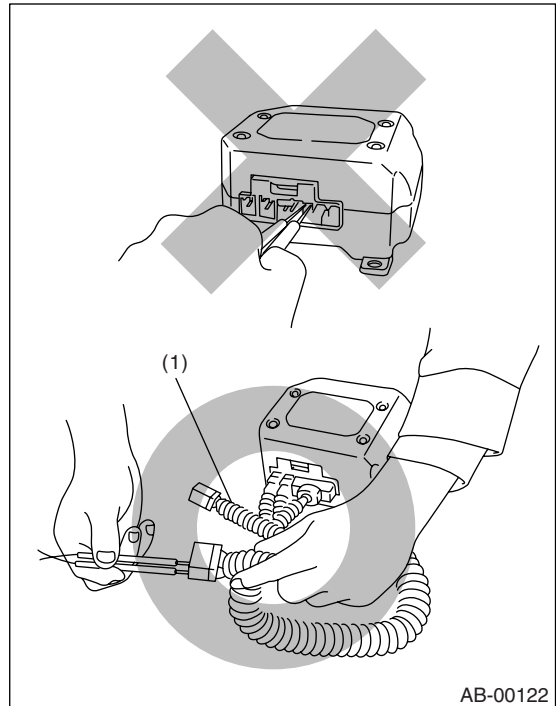

(1) Test harness

- Do not drop the airbag modulator parts, subject them to high temperature over 93°C (199°F), or let water, oil, or grease get on them; otherwise, the internal parts may be damaged and may be reliability greatly lowered.

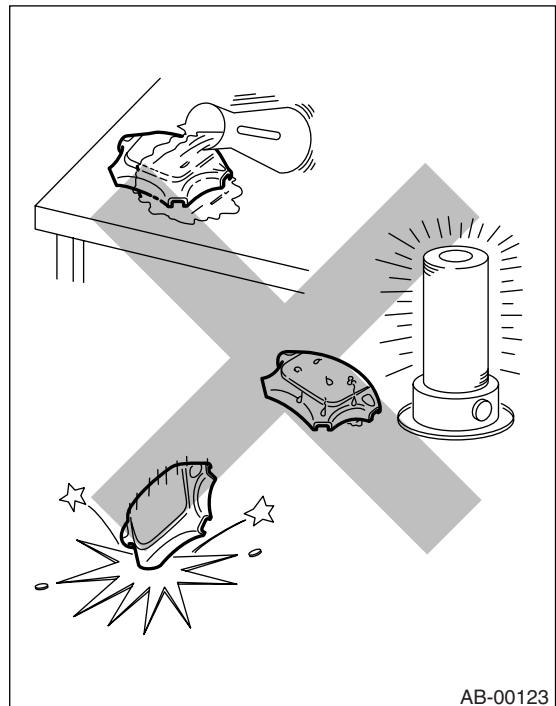

General Description

- If any damage, opening, or rust is found on the airbag system wire harness, do not attempt to repair using soldering equipment. Be sure to replace the faulty harness with a new genuine part.

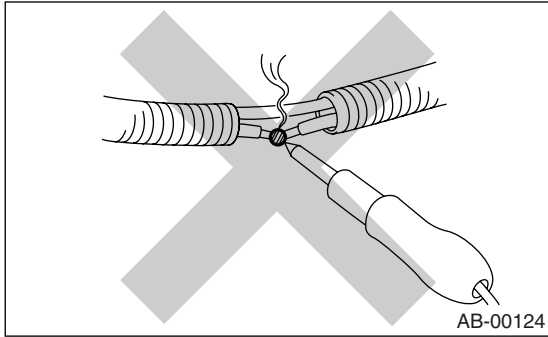

- Install the wire harness securely with the specified clips to avoid interference or tangled up with other parts.

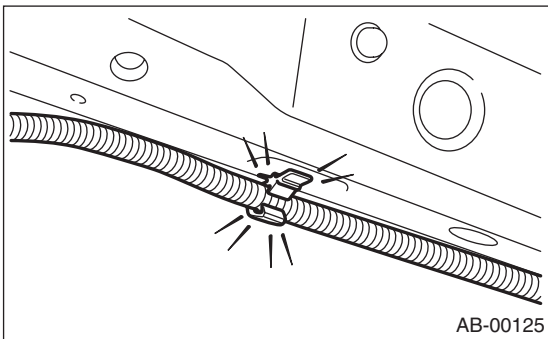

- Do not allow water or oil to come in contact with the connector terminals. Do not touch the connector terminals.

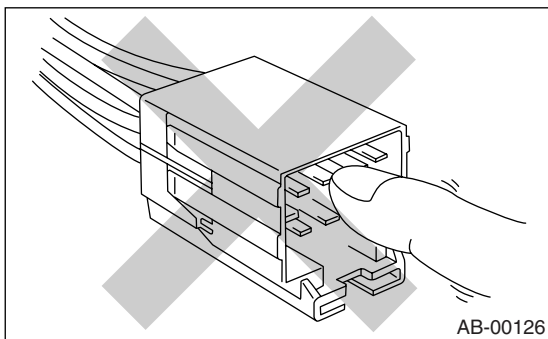

- Either of the airbag modules for driver, passenger or side, or pretensioner must not be disassembled.

- The airbag module cannot be used again if once inflated.

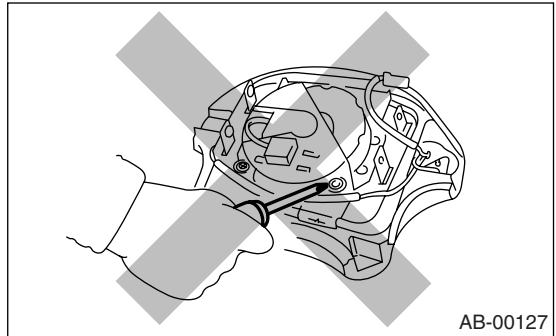

- After removal, keep the airbag module with the pad facing upward on a dry, clean, and flat surface away from heat and light sources, and moisture and dust.

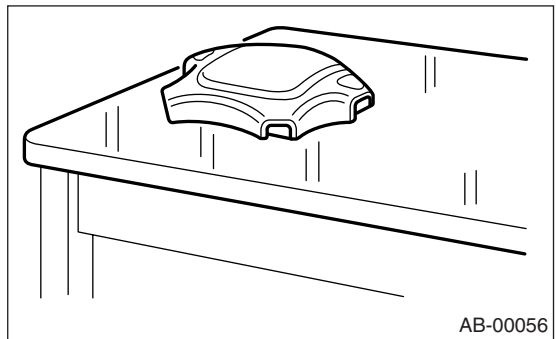

- Do not check continuity of either of the airbag modules for driver, passenger or side, or pretensioner.

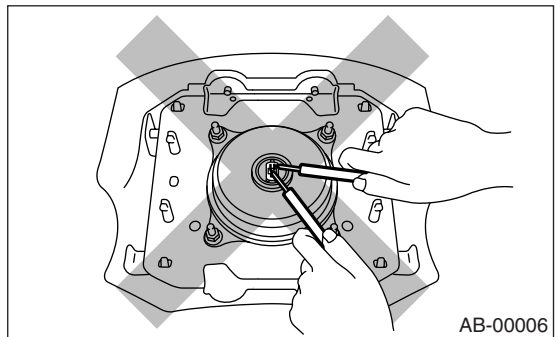

General Description

AIRBAG SYSTEM (DIAGNOSTICS)

- The removed front seat with the airbag module must be kept at least 200 mm (8 in) away from walls and other objects.

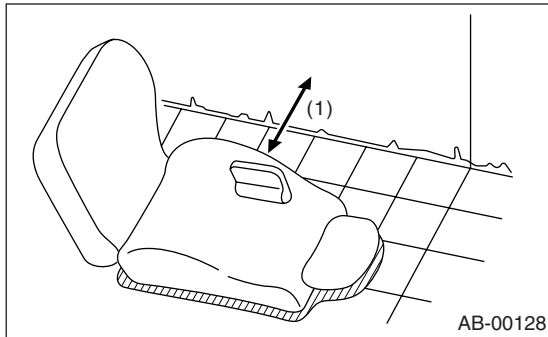

(1) More than 200 mm (8 in)

- When painting or performing sheet metal work on the front part of the vehicle, including the front wheel apron, front fender, and front side frame, remove the front sub sensors and wire harness of the airbag system.
- When painting or performing sheet metal work on the side of the vehicle, including the side sill, center pillar, and front and rear doors, remove the side airbag sensors and wire harness of the airbag system.

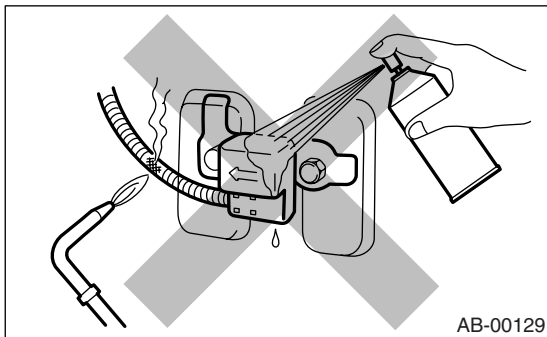

- Do not discard undeployed airbag modules. They could easily cause a serious accident if accidentally deployed.

General Description

AIRBAG SYSTEM (DIAGNOSTICS)

- When storing a removed airbag module, do not place any objects on it or pile airbag modules on top of each other. If the airbag inflates for some reason when it is placed with its pad side facing downward or under any object, a serious accident may result.

(1)

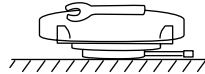
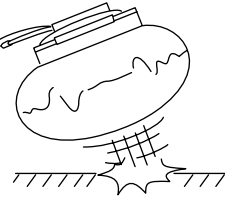
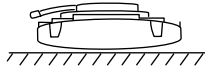
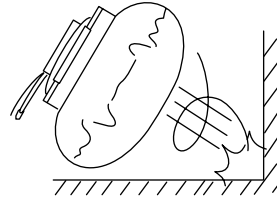
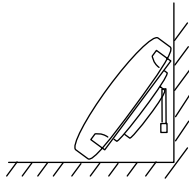
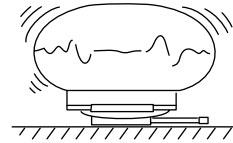
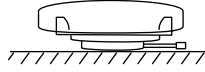

(2)

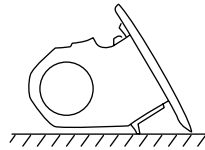
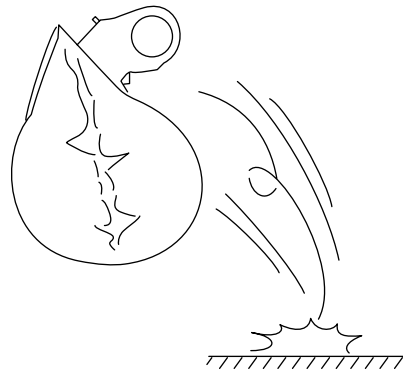
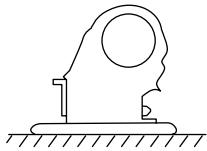
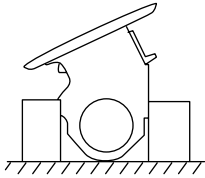

AB-00130

(1) Driver side airbag module

(2) Passenger side airbag module

General Description

AIRBAG SYSTEM (DIAGNOSTICS)

B: INSPECTION

Before diagnosing, check the following items that might be related to the engine problem:

1. BATTERY



Measure the battery voltage and specific gravity of electrolyte.

Standard voltage: 12 V

Specific gravity: Above 1.260

C: PREPARATION TOOL

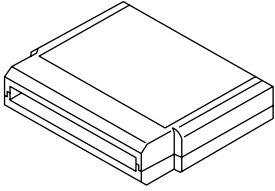
1. SPECIAL TOOL

ILLUSTRATION	TOOL NUMBER	DESCRIPTION	REMARKS
 ST18482AA010	18482AA010 (Newly adopted tool)	CARTRIDGE	Troubleshooting for electrical systems.
 ST22771AA030	22771AA030	SUBARU SELECT MONITOR KIT	Troubleshooting for electrical systems.

General Description

• TEST HARNESS F

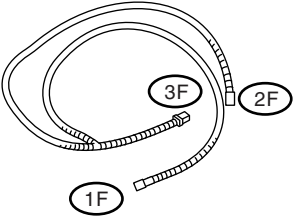
ILLUSTRATION	TOOL NUMBER	DESCRIPTION	REMARKS
 <p data-bbox="326 594 467 615">ST98299FC010</p>	98299FC010	TEST HARNESS F	Used when measuring voltage, resistance of side airbag module harness.

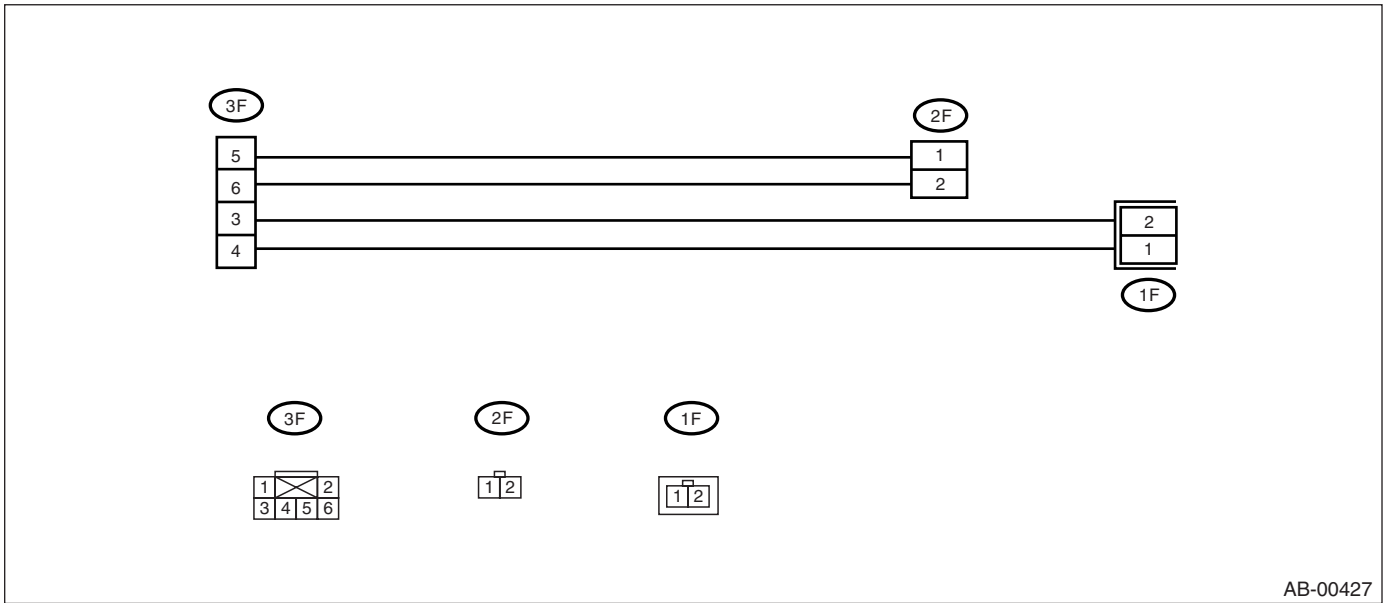

General Description

AIRBAG SYSTEM (DIAGNOSTICS)

• TEST HARNESS D

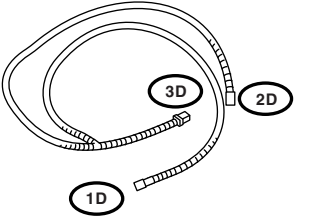
ILLUSTRATION	TOOL NUMBER	DESCRIPTION	REMARKS
 <p style="text-align: center;">ST98299AG060</p>	98299AG060	TEST HARNESS D	Used when measuring voltage and resistance of front seat belt buckle switch.

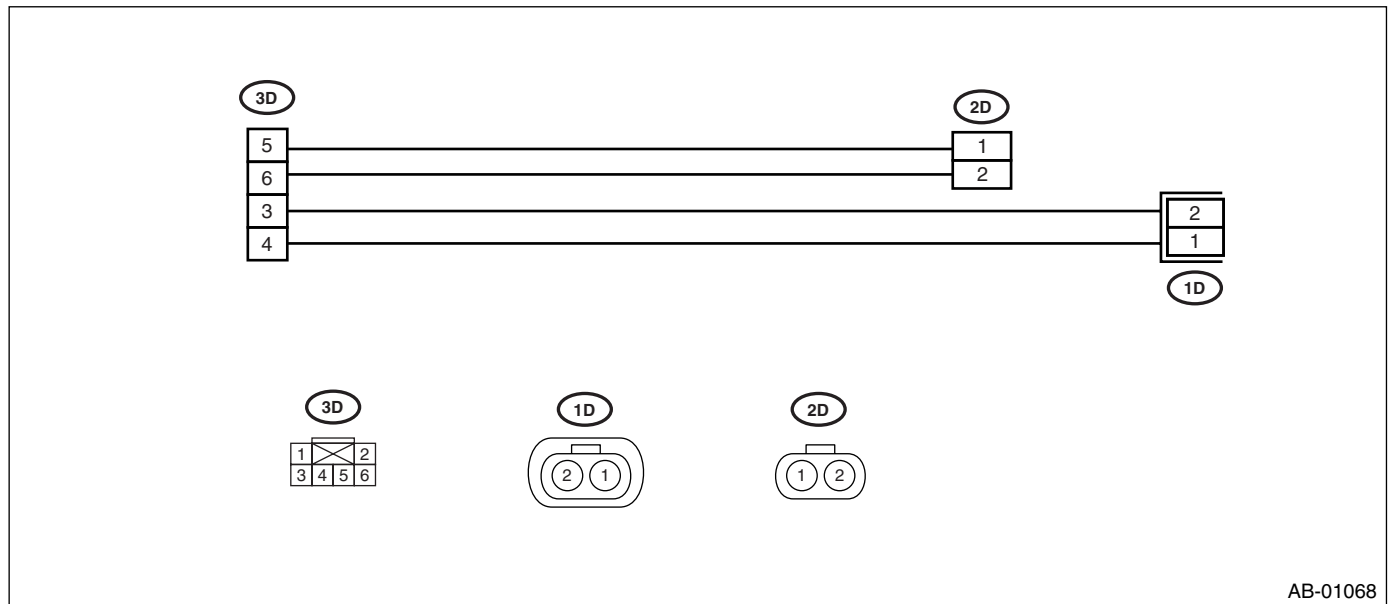

General Description

• TEST HARNESS H

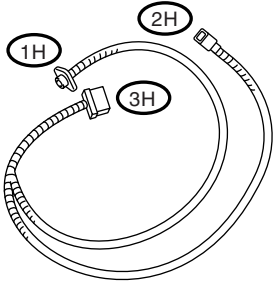
ILLUSTRATION	TOOL NUMBER	DESCRIPTION	REMARKS
 <p data-bbox="326 594 467 615">ST98299FA030</p>	98299FA030	TEST HARNESS H	Used when measuring voltage, resistance of front sub sensor.

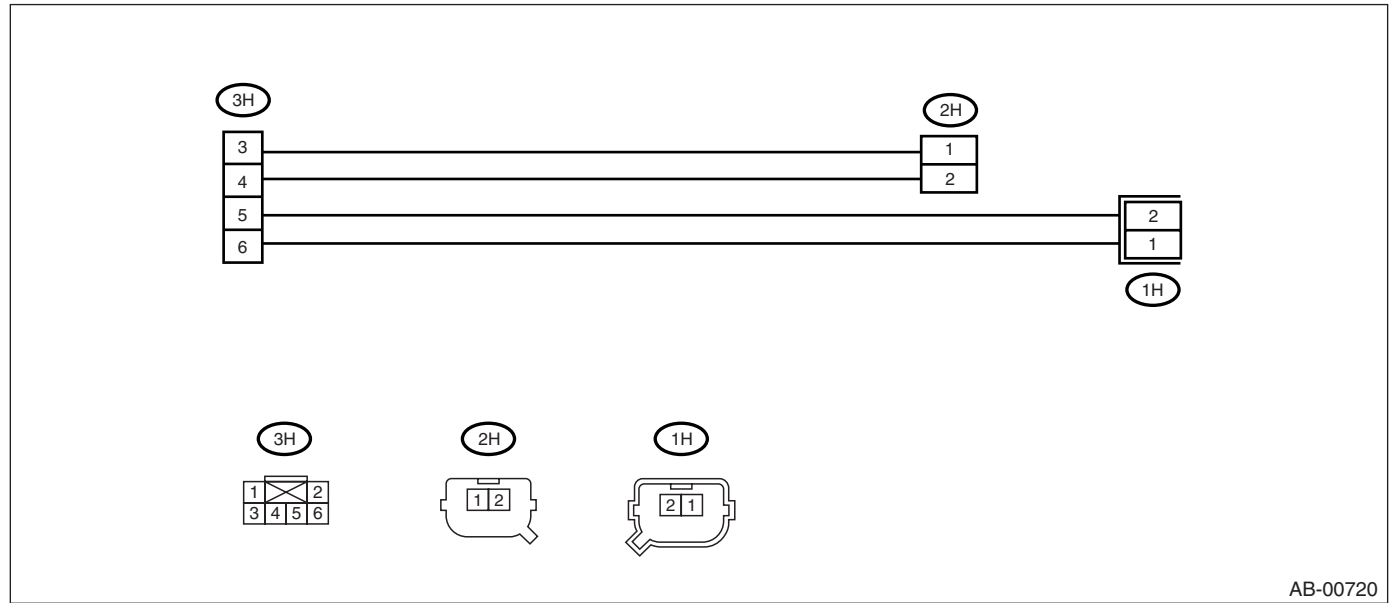

General Description

AIRBAG SYSTEM (DIAGNOSTICS)

• TEST HARNESS N

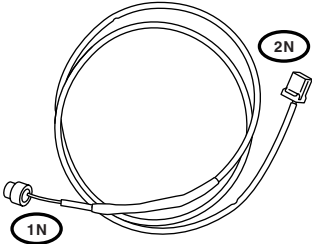
ILLUSTRATION	TOOL NUMBER	DESCRIPTION	REMARKS
 <p style="text-align: center;">ST98299SA000</p>	98299SA000	TEST HARNESS N	Used when measuring voltage, resistance of driver's airbag module and seat belt pretensioner.

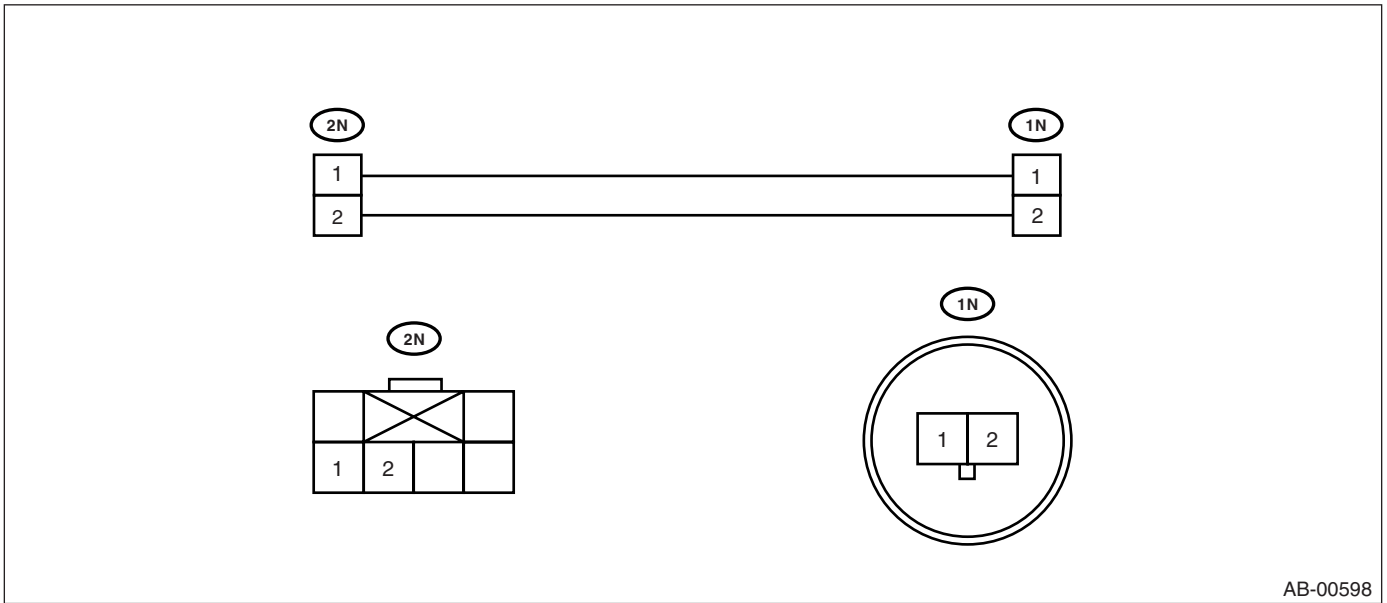

General Description

• TEST HARNESS P

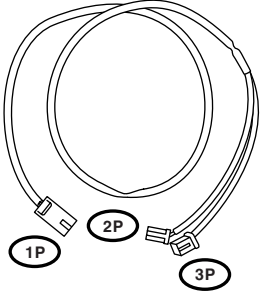
ILLUSTRATION	TOOL NUMBER	DESCRIPTION	REMARKS
 <p>ST98299SA020</p>	98299SA020	TEST HARNESS P	Used when measuring voltage and resistance of driver's airbag module harness and passenger's airbag module harness.

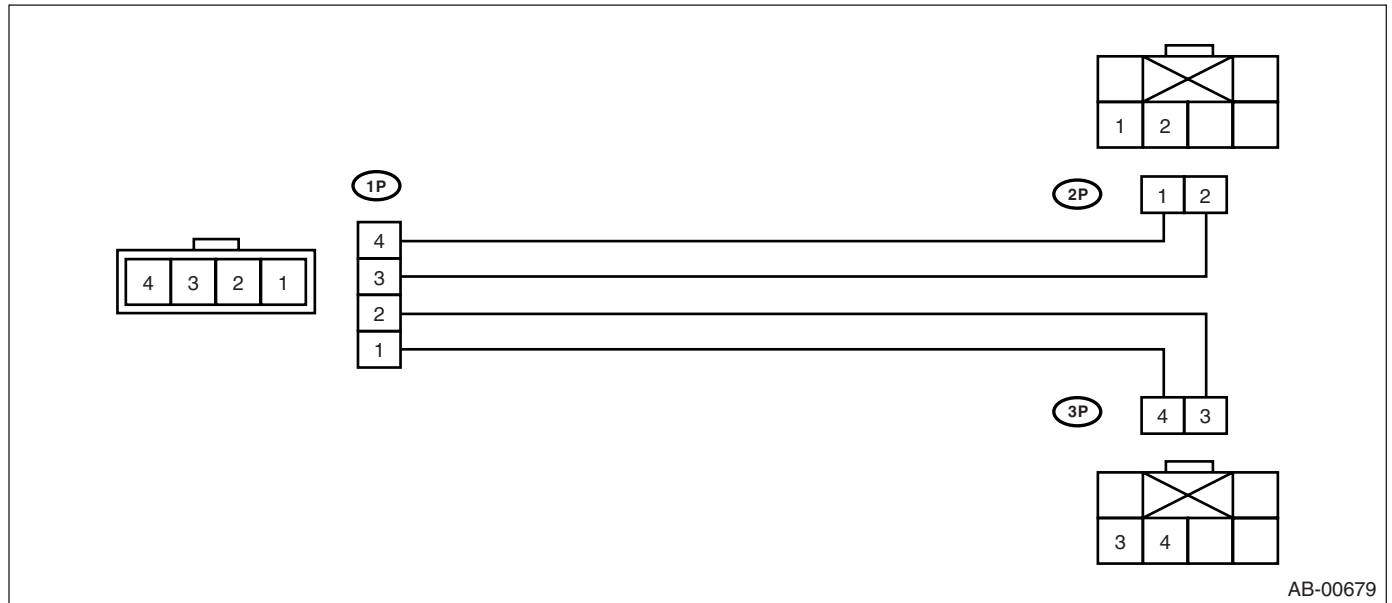

General Description

AIRBAG SYSTEM (DIAGNOSTICS)

• TEST HARNESS Q

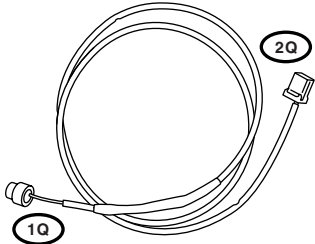
ILLUSTRATION	TOOL NUMBER	DESCRIPTION	REMARKS
 <p style="text-align: center;">ST98299SA040</p>	98299SA040	TEST HARNESS Q	Used when measuring voltage and resistance of driver's airbag module.

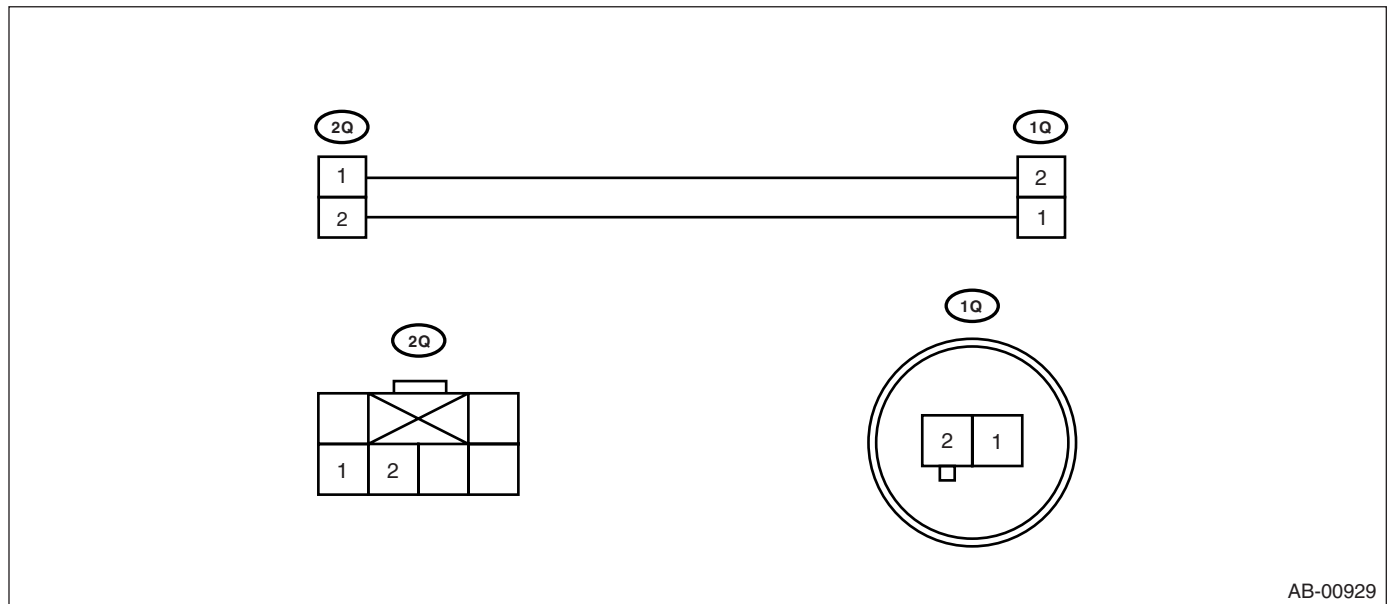

AB-00929

General Description

AIRBAG SYSTEM (DIAGNOSTICS)

• TEST HARNESS U

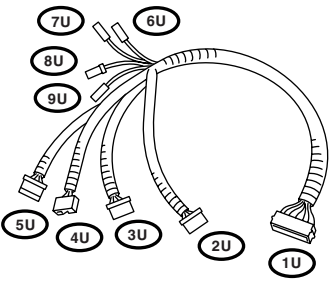
ILLUSTRATION	TOOL NUMBER	DESCRIPTION	REMARKS
 <p>The diagram shows a test harness with a central bundle of wires. On the left side, there are nine terminals labeled 1U through 9U. On the right side, there is a single terminal labeled 1U. The part number ST98299AG000 is printed at the bottom of the diagram.</p>	98299AG000	TEST HARNESS U	Used when measuring voltage and resistance of airbag control module.

General Description

AIRBAG SYSTEM (DIAGNOSTICS)

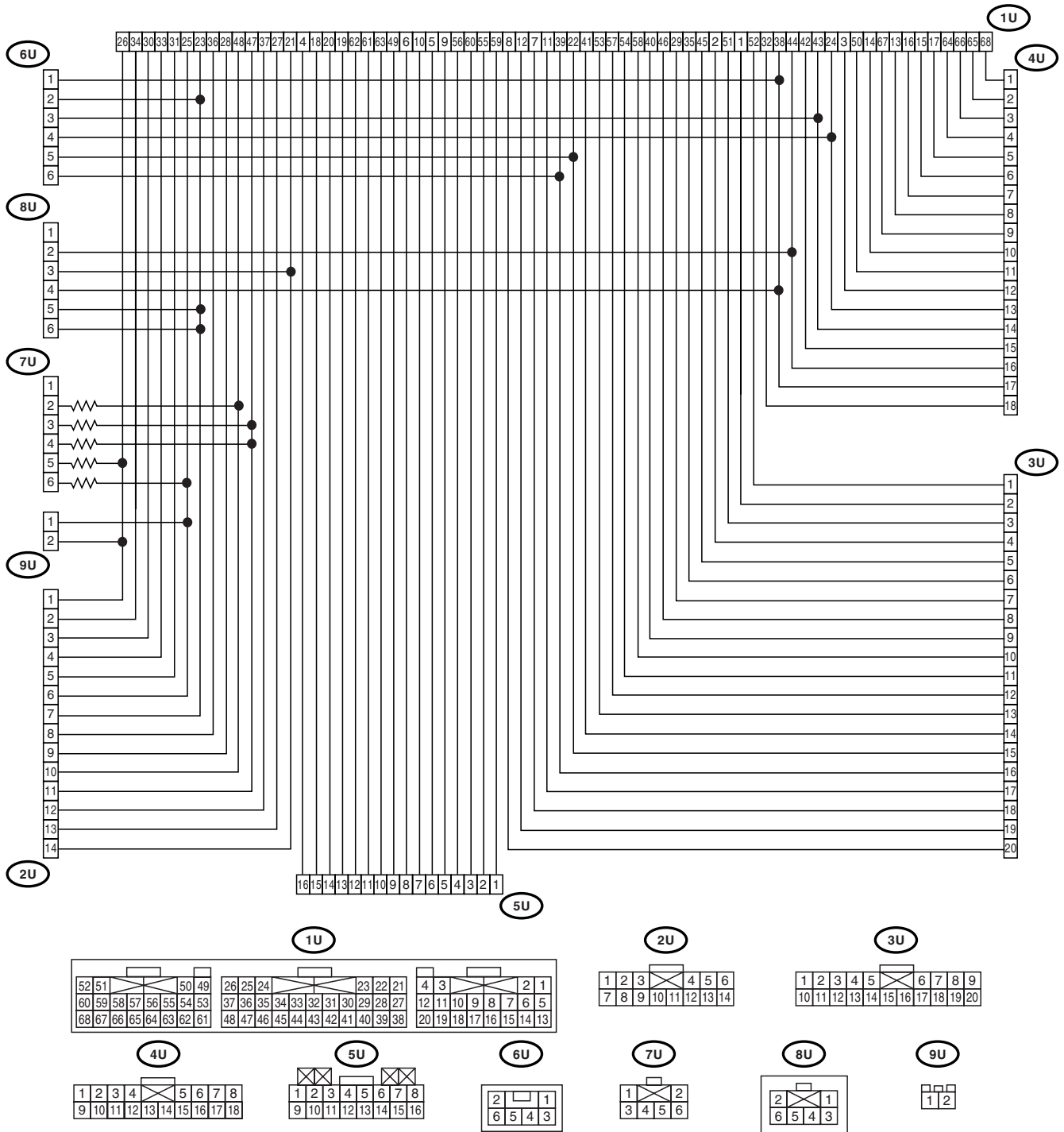

AB-00930

General Description

AIRBAG SYSTEM (DIAGNOSTICS)

• TEST HARNESS R

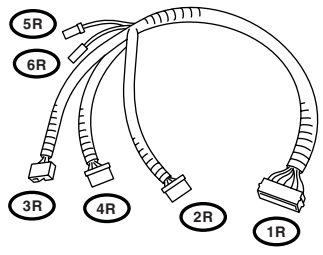
ILLUSTRATION	TOOL NUMBER	DESCRIPTION	REMARKS
 <p>ST98299FE030</p>	98299FE030	TEST HARNESS R	Used when measuring voltage, resistance of air-bag control module.

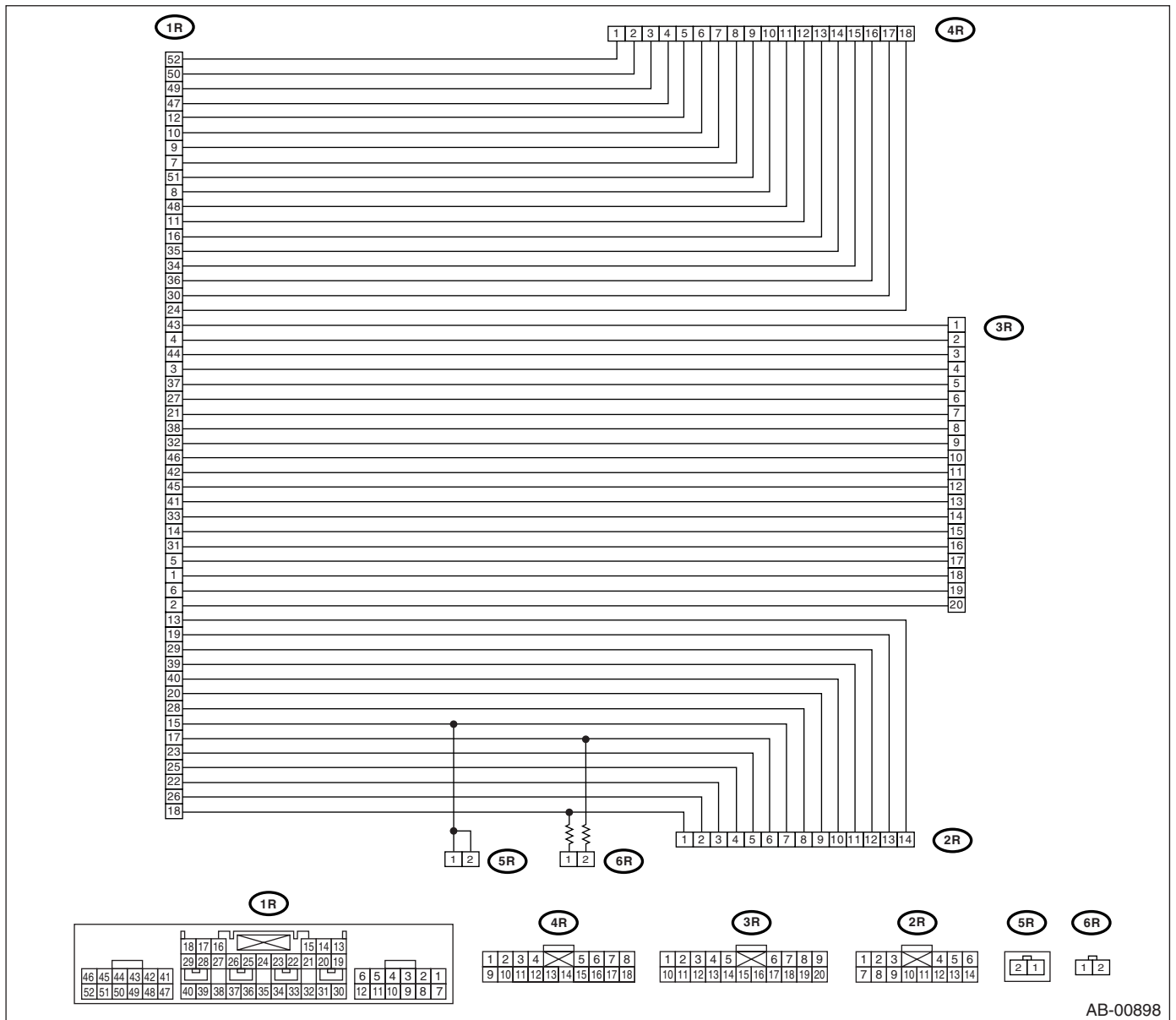

AB-00898

General Description

AIRBAG SYSTEM (DIAGNOSTICS)

• TEST HARNESS V

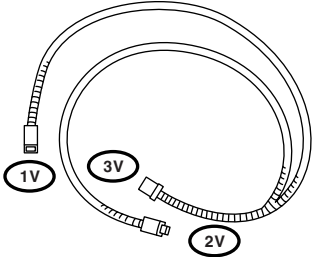
ILLUSTRATION	TOOL NUMBER	DESCRIPTION	REMARKS
 <p style="text-align: center;">ST98299AG010</p>	98299AG010	TEST HARNESS V	Used when measuring voltage and resistance of side airbag sensor.

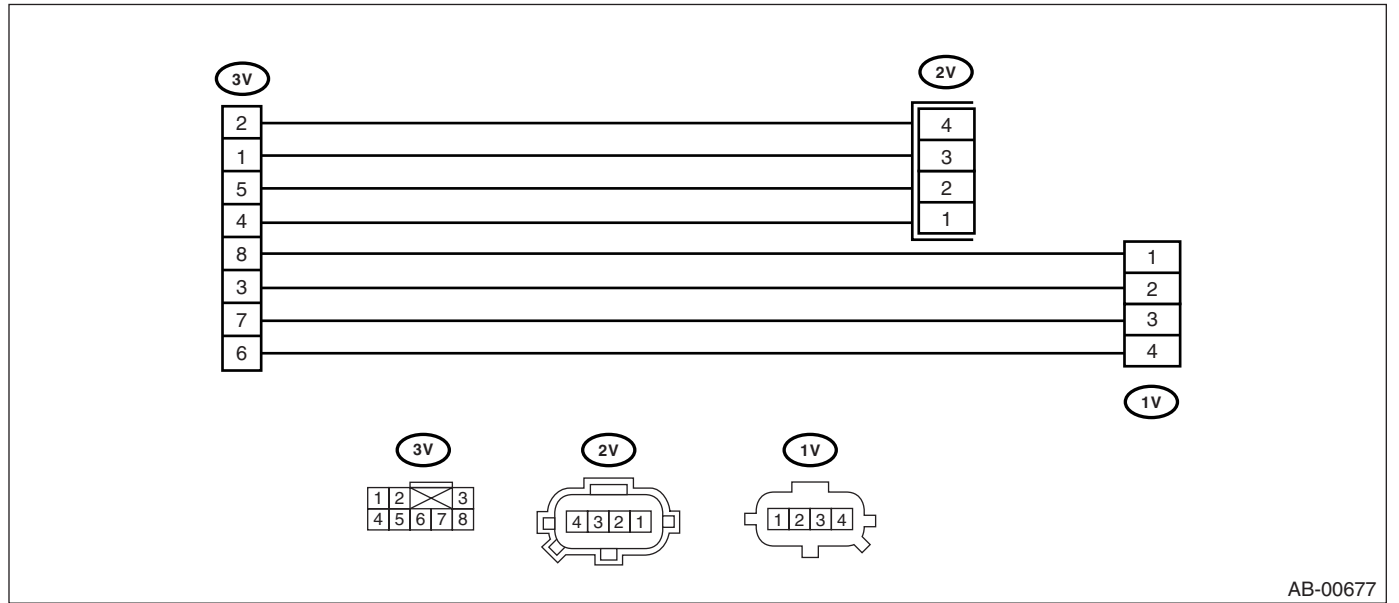

General Description

AIRBAG SYSTEM (DIAGNOSTICS)

• TEST HARNESS Y

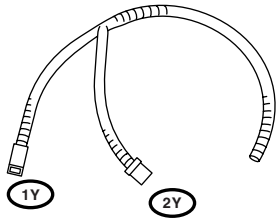
ILLUSTRATION	TOOL NUMBER	DESCRIPTION	REMARKS
 <p data-bbox="321 594 467 615">ST98299AG040</p>	98299AG040	TEST HARNESS Y	Used when diagnosing seat belt buckle switch and seat position sensor.

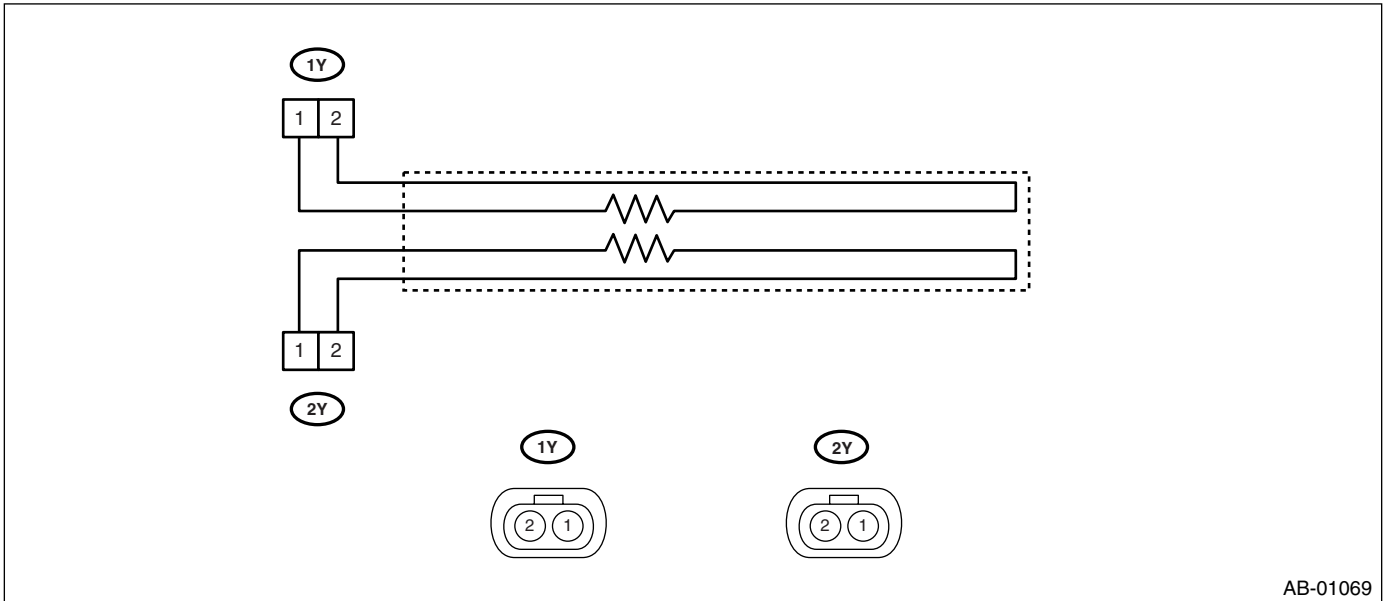

General Description

AIRBAG SYSTEM (DIAGNOSTICS)

• TEST HARNESS Z

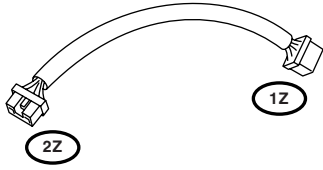
ILLUSTRATION	TOOL NUMBER	DESCRIPTION	REMARKS
 <p data-bbox="324 594 467 615">ST98299AG050</p>	98299AG050	TEST HARNESS Z	Used when measuring voltage and resistance of occupant detection system.

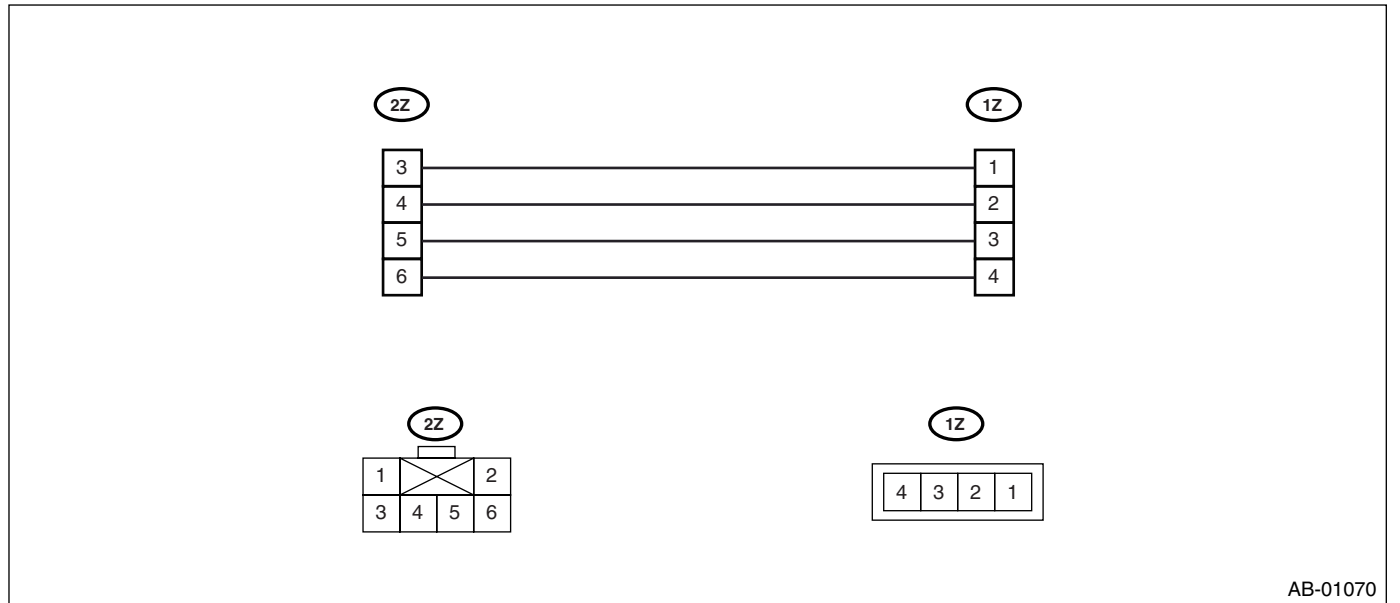

AB-01070

General Description

AIRBAG SYSTEM (DIAGNOSTICS)

• AIRBAG RESISTOR

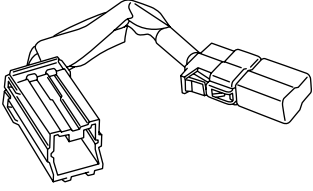
ILLUSTRATION	TOOL NUMBER	DESCRIPTION	REMARKS
 <p data-bbox="326 596 467 615">ST98299PA040</p>	98299PA040	AIRBAG RESISTOR	Used in replacement of airbag module which resistance value is same as airbag module.

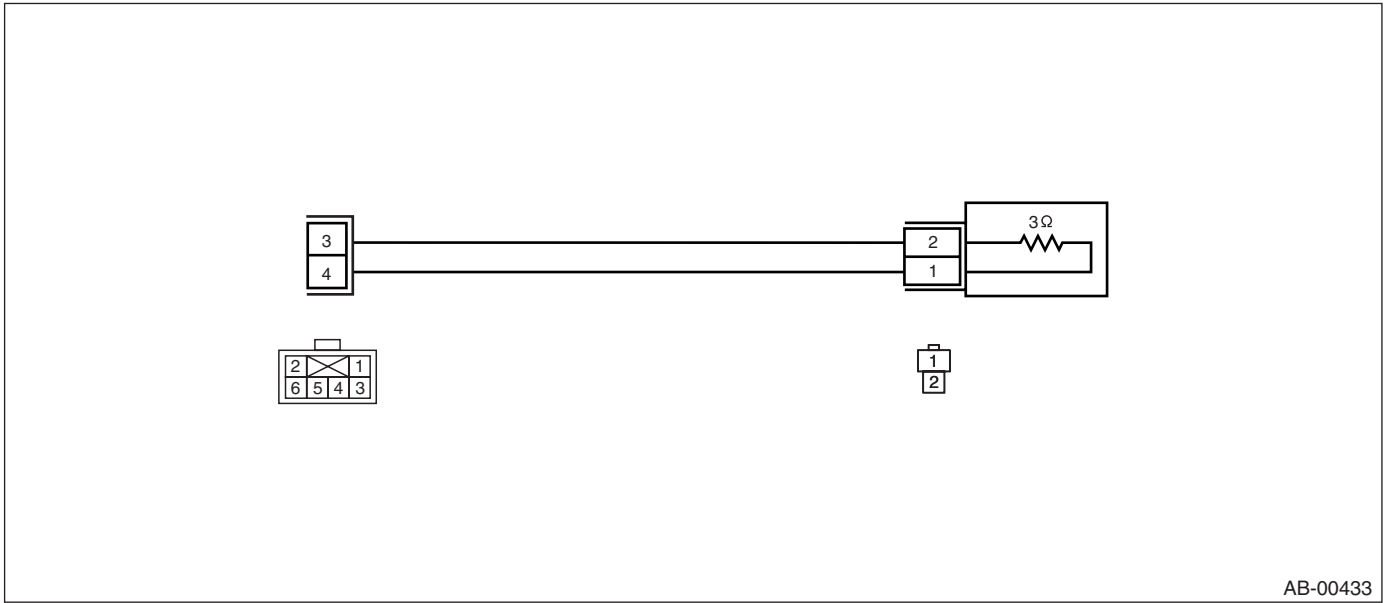

AB-00433

Electrical Component Location

AIRBAG SYSTEM (DIAGNOSTICS)

4. Electrical Component Location

A: LOCATION

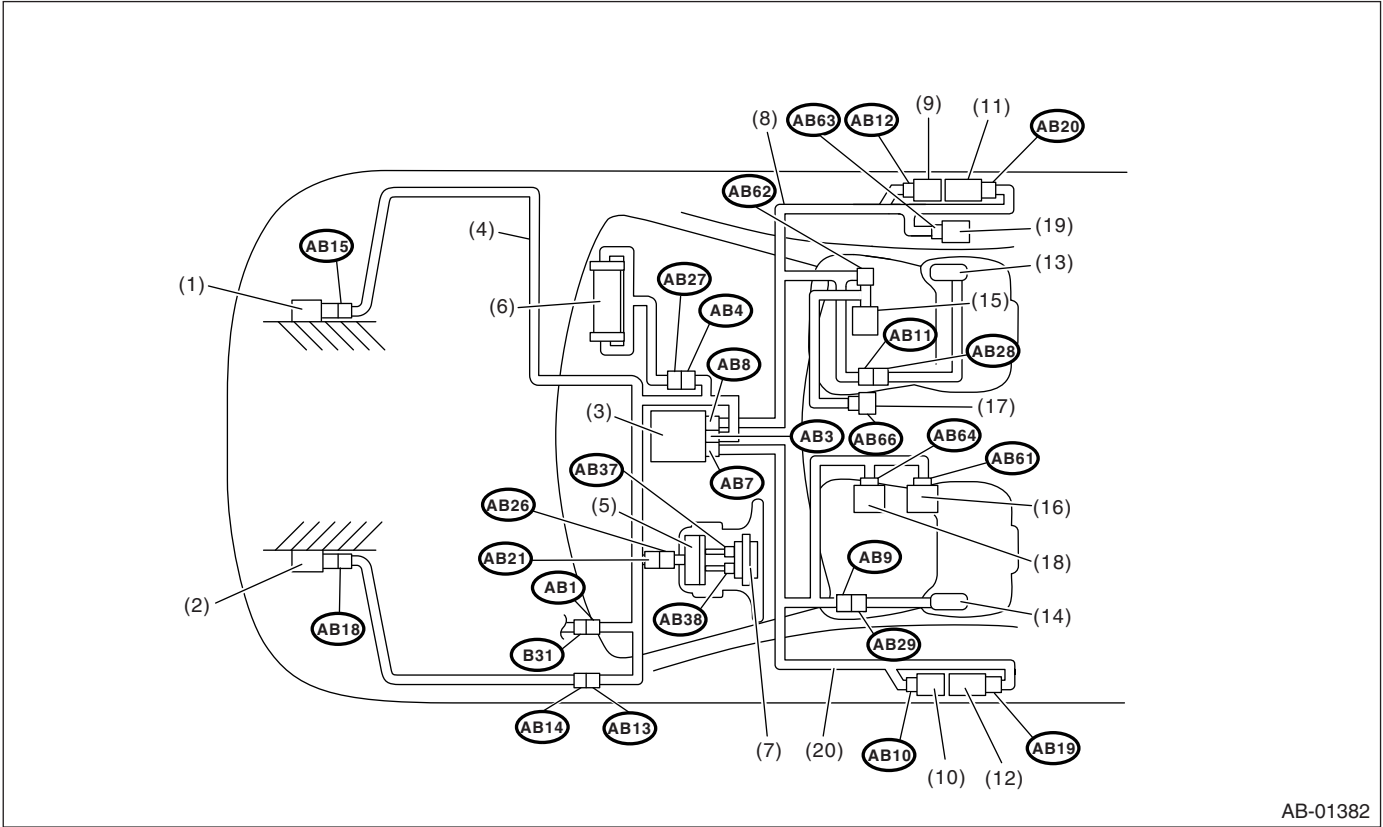

AB-01382

- | | | |
|--|----------------------------------|--|
| (1) Front sub sensor (RH) | (8) Side airbag harness (RH) | (15) Occupant detection control module |
| (2) Front sub sensor (LH) | (9) Side airbag sensor (RH) | (16) Buckle switch (LH) |
| (3) Airbag control module with built-in safety and electric sensor | (10) Side airbag sensor (LH) | (17) Buckle switch (RH) |
| (4) Airbag main harness | (11) Seat belt pretensioner (RH) | (18) Seat position sensor |
| (5) Roll connector | (12) Seat belt pretensioner (LH) | (19) Belt tension sensor |
| (6) Passenger side airbag module | (13) Side airbag module (RH) | (20) Side airbag harness (LH) |
| (7) Driver side airbag module | (14) Side airbag module (LH) | |

Connector No.	(AB1)	(AB3)	(AB4)	(AB7)	(AB8)	(AB9)	(AB10)	(AB11)	(AB12)	(AB13)	(AB14)	(AB15)
Pole	6	28	4	12	12	2	4	2	4	2	2	2
Connector color	Yellow	Yellow	Yellow	Yellow	Yellow	Yellow	Yellow	Yellow	Yellow	Yellow	Yellow	Yellow
Male/Female	Male	Female	Female	Female	Female	Female	Female	Female	Female	Female	Male	Female
Connector No.	(AB18)	(AB19)	(AB20)	(AB21)	(AB26)	(AB27)	(AB28)	(AB29)	(AB37)	(AB38)	(AB61)	(AB62)
Pole	2	2	2	4	4	4	2	2	2	2	2	6
Connector color	Yellow	Black	Black	Yellow	Yellow	Yellow	Yellow	Yellow	Orange	Black	Yellow	Gray
Male/Female	Female	Female	Female	Female	Male	Male	Male	Male	Female	Female	Male	Female

Electrical Component Location

AIRBAG SYSTEM (DIAGNOSTICS)

Connector No.	(AB63)	(AB64)	(AB66)	—	—	—	—	—	—	—	—	—
Pole	3	2	2	—	—	—	—	—	—	—	—	—
Connector color	Brown	Yellow	Yellow	—	—	—	—	—	—	—	—	—
Male/ Female	Female	Female	Female	—	—	—	—	—	—	—	—	—

5. Airbag Control Module I/O Signal

A: WIRING DIAGRAM

Refer to wiring diagrams in WI section. <Ref. to WI-96, WIRING DIAGRAM, Airbag System.>

6. Airbag Connector

A: PROCEDURE

1. BUCKLE SWITCH AND OCCUPANT DETECTION CONTROL MODULE

1) How to disconnect

- (1) Move the slide lock (A) in the direction of the arrow.
- (2) Disconnect the connector with the slide lock (A) moved.

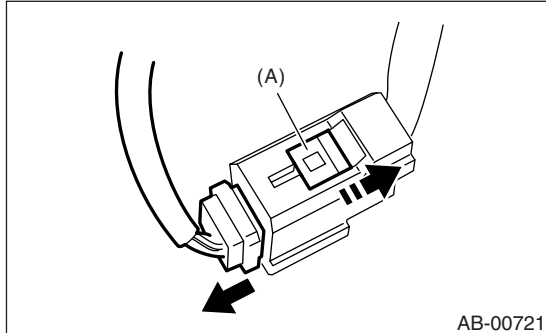

CAUTION:

When pulling the slide lock or disconnecting connector, be sure to hold the connector, not the harness.

2) How to connect

Holding the connector (A), and push it in carefully until a connecting sound is heard.

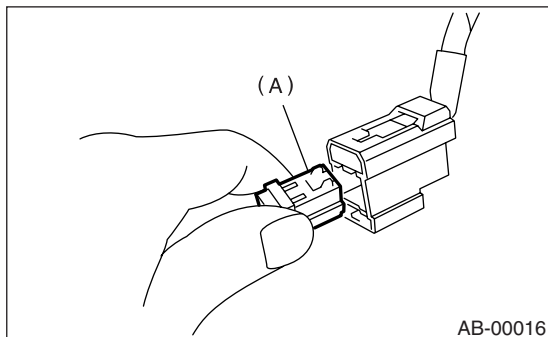

CAUTION:

Be sure to insert the connector in until it is locked. Then pull it gently to make sure that it is locked.

2. DRIVER'S AIRBAG MODULE AND PRE-TENSIONER

1) How to disconnect

- (1) Using a flat tip screwdriver, pry the push lock upward to unlock.

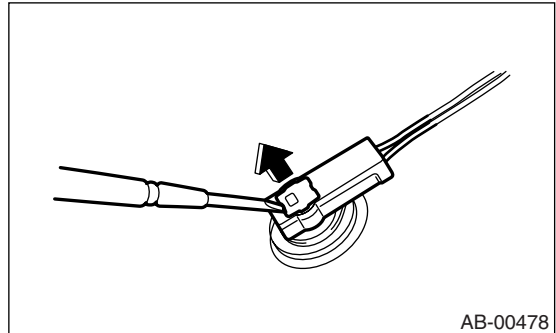

- (2) Pull the connector to disconnect from driver's side airbag module assembly or retractor assembly.

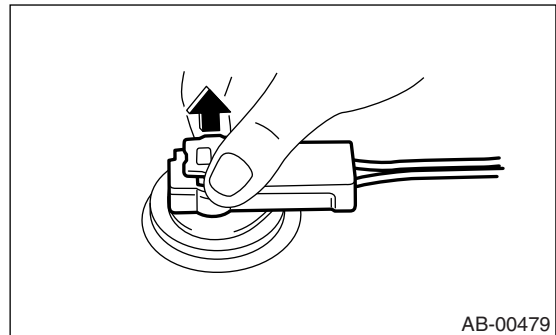

2) How to connect

Connect the connector in reverse order of disconnecting. At this time, be sure to insert the push lock in until connecting sound is heard.

CAUTION:

- Be sure to insert the connector in until it is locked. Then pull it gently to make sure that it is locked.
- Be sure to push the push lock in securely.

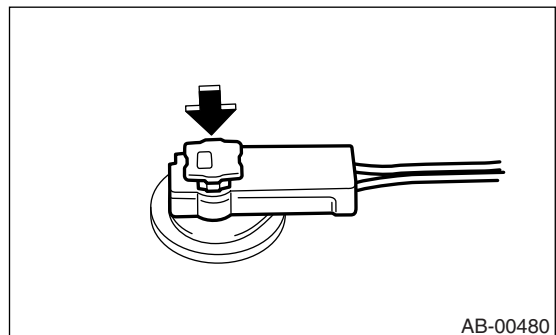

NOTE:

Connector can not be connected when the push lock is in lock position. To connect the connector, set the push lock to unlock position.

Airbag Connector

AIRBAG SYSTEM (DIAGNOSTICS)

3. DRIVER'S AIRBAG (BETWEEN AIRBAG MAIN HARNESS AND ROLL CONNECTOR) AND PASSENGER'S AIRBAG

1) How to disconnect

- (1) Press in the slide lock (A) in the direction of arrow.

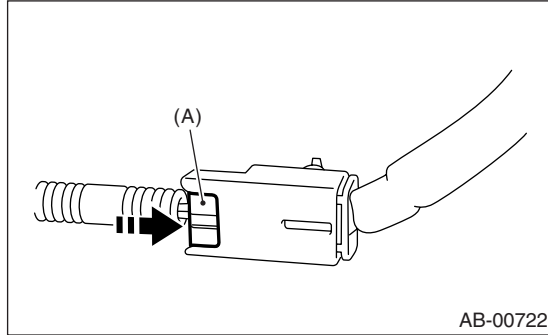

- (2) With the slide lock (A) pressed in, disconnect the connector.

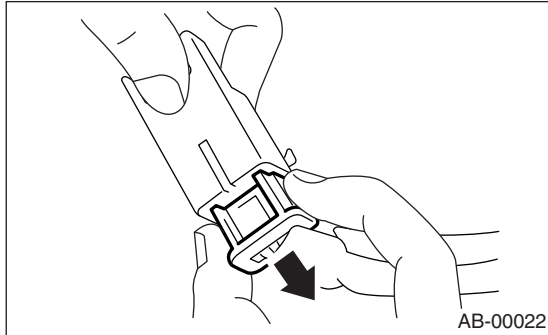

CAUTION:
When pulling the slide lock or disconnecting connector, be sure to hold the connector, not the harness.

2) How to connect

Holding the connector, push it in carefully until a connecting sound is heard.

CAUTION:
Be sure to insert the connector in until it locks. Then pull it gently to make sure that it is locked.

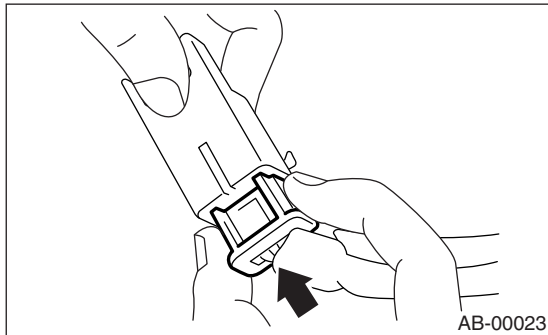

4. SIDE AIRBAG

1) How to disconnect

- (1) Push the lock arm (A).
- (2) With the lock arm (A) pushed in, move the slide lock (B) in the direction of the arrow.

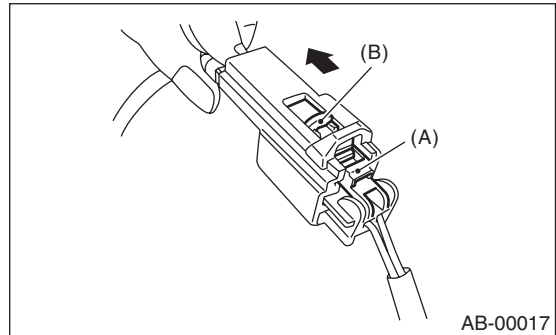

- (3) With the slide lock moved, release the lock arm (back to its original position), and disconnect the connector.

CAUTION:
When pulling the slide lock or disconnecting connector, be sure to hold the connector, not the harness.

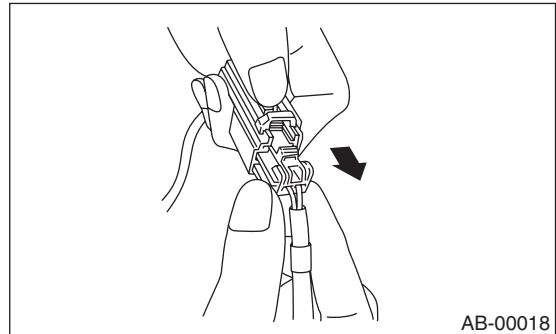

2) How to connect

Holding the connector, push it in carefully until a connecting sound is heard.

5. FRONT SUB-SENSOR, SIDE AIRBAG SENSOR, SEAT POSITION SENSOR LH

1) How to disconnect

Holding outer part (A), pull it in the direction of the arrow.

CAUTION:

When pulling the slide lock or disconnecting connector, be sure to hold the connector, not the harness.

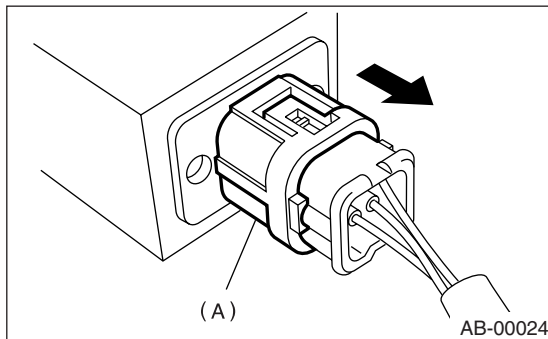

2) How to connect

Holding the connector, push it in carefully until a connecting sound is heard.

CAUTION:

- Outer (A) moves back, and so do not put your hand on the outer part.
- Be sure to insert the connector in until it locks. Then pull it gently to make sure that it is locked.

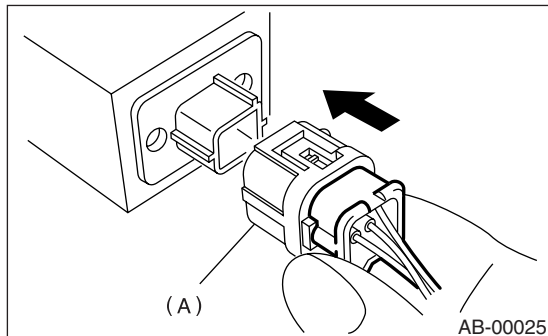

Subaru Select Monitor

AIRBAG SYSTEM (DIAGNOSTICS)

7. Subaru Select Monitor

A: OPERATION

1. READ DIAGNOSTIC TROUBLE CODE (DTC)

When malfunction of airbag system occurs, the DTC stored in airbag control module will be read out.

1) Prepare the Subaru Select Monitor kit. <Ref. to AB(diag)-8, SPECIAL TOOL, PREPARATION TOOL, General Description.>

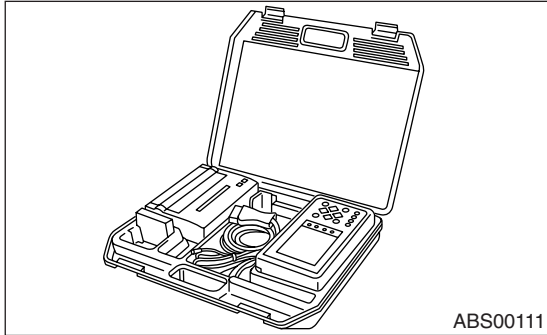

2) Connect the diagnosis cable to Subaru Select Monitor.

3) Insert the cartridge into Subaru Select Monitor. <Ref. to AB(diag)-8, SPECIAL TOOL, PREPARATION TOOL, General Description.>

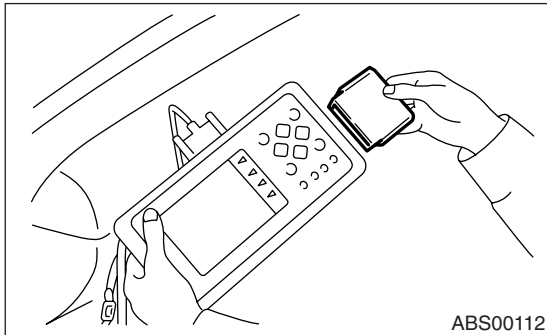

4) Connect the Subaru Select Monitor to data link connector.

(1) Data link connector is located in the lower portion of the instrument panel (on the driver's side).

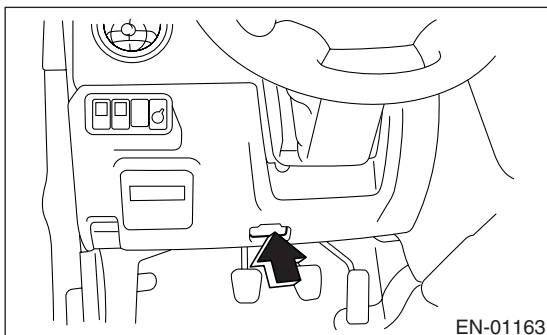

(2) Connect the diagnosis cable to data link connector.

CAUTION:

Do not connect the scan tools except for Subaru Select Monitor.

5) Turn the ignition switch to ON (engine OFF), and Subaru Select Monitor power switch to ON.

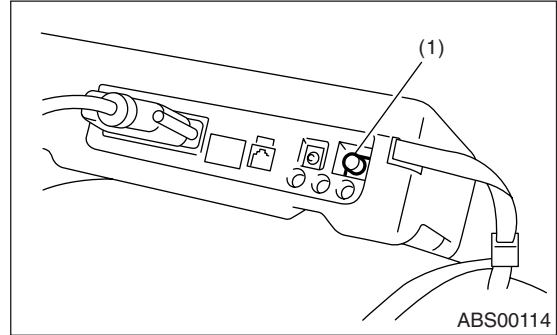

(1) Power switch

6) On the «Main Menu» display screen, select the {Each System Check} and press the [YES] key.

7) On the «System Selection Menu» display screen, select the {Airbag System} and press the [YES] key.

8) Press the [YES] key after the {AIRBAG SYSTEM} is displayed.

9) On the «Airbag System» display screen, select the {DTC Display} and press the [YES] key.

NOTE:

- For details concerning operation procedure, refer to the "SUBARU SELECT MONITOR OPERATION MANUAL".

- For details concerning DTCs, refer to the "List of Diagnostic Trouble Code (DTC)". <Ref. to AB(diag)-45, List of Diagnostic Trouble Code (DTC).>

2. STATUS DATA DISPLAY

Check the operating condition of each sensor in the event of malfunction in seat belt buckle switch and seat position sensor, or when the seat belt buckle switch and seat position sensor has been replaced.

- 1) On the «Main Menu» display screen, select the {Each System Check} and press the [YES] key.
- 2) On the «System Selection Menu» display screen, select the {Airbag System} and press the [YES] key.
- 3) On the «Airbag System» display screen, select the {Status Data} and press the [YES] key.

The support data is shown in the following table.

Item	Display
Seat position sensor LH	Front ^{*1} /Rear ^{*2} /Other ^{*3} /Unknown ^{*3} /___ ^{*5}
Seat position sensor RH	___ ^{*5}
Seat belt buckle switch LH	Belted ^{*6} /Unbelted ^{*7} /Other ^{*8} /Unknown ^{*4} /___ ^{*9}
Seat belt buckle switch RH	Belted ^{*6} /Unbelted ^{*7} /Other ^{*8} /Unknown ^{*4} /___ ^{*9}
Passenger's airbag firing status	ON ^{*10} /OFF ^{*11} /Unknown ^{*4}

- *1: The seat position is forward.
- *2: The seat position is rearward.
- *3: It is displayed when data other than forward and backward positions of the seat, such as malfunction etc., is input.
- *4: It is displayed at the initial status.
- *5: Seat position sensor is not available.
- *6: Seat belt is fastened.
- *7: Seat belt is unfastened.
- *8: It is displayed when data other than fastened or unfastened belts, such as malfunction etc., is input.
- *9: Seat belt buckle switch is not available.
- *10: Passenger's airbag is active.
- *11: Passenger's airbag is not active.

NOTE:

For details concerning operation procedure, refer to the SUBARU SELECT MONITOR OPERATION MANUAL.

3. CLEAR MEMORY MODE

Clear the DTC stored in the airbag control module after repairing malfunction in airbag system. If the memory is not cleared after repairing malfunction, repaired DTC will be read out again when a new malfunction occurs.)

- 1) On the «Main Menu» display screen, select the {Each System Check} and press the [YES] key.
- 2) On the «System Selection Menu» display screen, select the {Airbag System} and press the [YES] key.
- 3) On the «Airbag System» display screen, select the {Clear Memory} and press the [YES] key.
- 4) Press the [YES] key after the "Clear memory?" has been displayed.
- 5) When the "Done" is shown on the display screen, turn the Subaru Select Monitor switch to OFF.

NOTE:

For details concerning operation procedure, refer to the SUBARU SELECT MONITOR OPERATION MANUAL.

Subaru Select Monitor

AIRBAG SYSTEM (DIAGNOSTICS)

B: INSPECTION

1. COMMUNICATION FOR INITIALIZING IMPOSSIBLE

DETECTING CONDITION:

Defective harness connector

TROUBLE SYMPTOM:

Communication is impossible between airbag control module and Subaru Select Monitor.

WIRING DIAGRAM:

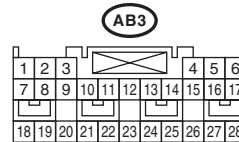
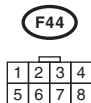
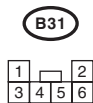
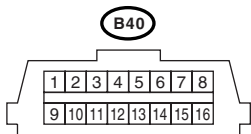
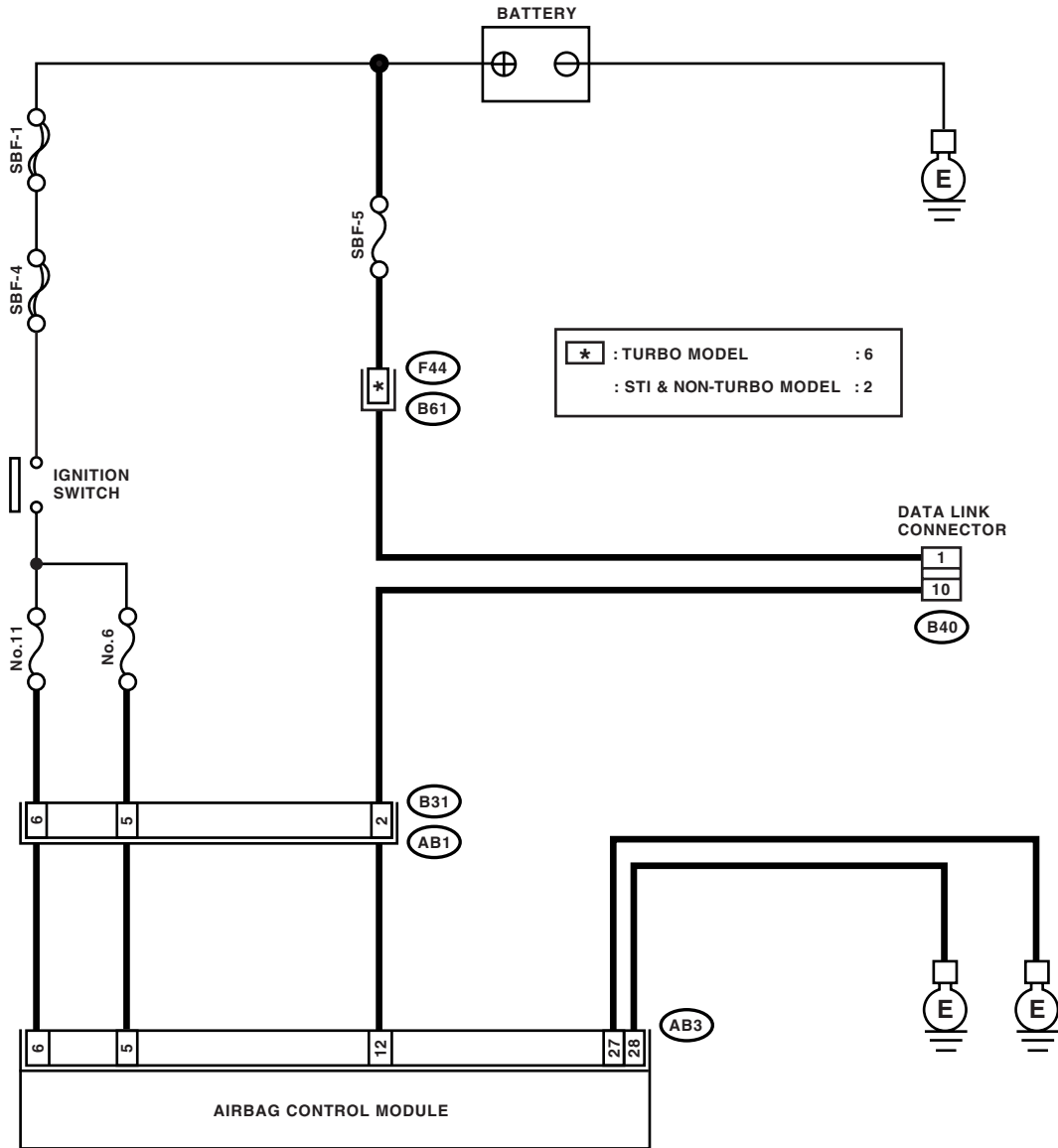

AB-01337

Subaru Select Monitor

AIRBAG SYSTEM (DIAGNOSTICS)

Step	Check	Yes	No
1	CHECK IGNITION SWITCH.	Does the ignition switch turn to ON?	Go to step 2. Turn the ignition switch to ON, and select airbag mode using Subaru Select Monitor.
2	CHECK BATTERY. 1) Turn the ignition switch to OFF. 2) Measure the battery voltage.	Is the voltage more than 11 V?	Go to step 3. Charge or replace the battery.
3	CHECK BATTERY TERMINAL.	Is there poor contact at battery terminal?	Repair or tighten the battery terminal. Go to step 4.
4	CHECK SUBARU SELECT MONITOR COMMUNICATION. 1) Turn the ignition switch to ON. 2) Using Subaru Select Monitor, check whether communication to other system can be executed normally.	Is the name of system displayed on Subaru Select Monitor?	Go to step 8. Go to step 5.
5	CHECK SUBARU SELECT MONITOR COMMUNICATION. 1) Turn the ignition switch to OFF. 2) Disconnect the airbag control module connector. 3) Turn the ignition switch to ON. 4) Check whether communication to other systems can be executed normally.	Is the name of system displayed on Subaru Select Monitor?	Replace the airbag control module. <Ref. to AB-18, Airbag Control Module.> Go to step 6.
6	CHECK HARNESS CONNECTOR BETWEEN EACH CONTROL MODULE AND DATA LINK CONNECTOR. 1) Turn the ignition switch to OFF. 2) Disconnect the airbag control module, ABSCM&H/U, ECM and TCM. 3) Measure the resistance between data link connector and chassis ground. Connector & terminal (B40) No. 10 — Chassis ground:	Is the resistance more than 1 MΩ?	Go to step 7. Repair the harness and connector between each control module and data link connector. (Airbag harness must be replaced with harness. Do not attempt to repair it.)
7	CHECK OUTPUT SIGNAL FOR AIRBAG CONTROL MODULE. 1) Turn the ignition switch to ON in step 7 condition. 2) Measure the voltage between data link connector and chassis ground. Connector & terminal (B40) No. 10 (+) — Chassis ground (-):	Is the voltage less than 1 V?	Go to step 8. Repair the harness and connector between each control module and data link connector. (Airbag harness must be replaced with harness. Do not attempt to repair it.)

Subaru Select Monitor

AIRBAG SYSTEM (DIAGNOSTICS)

Step	Check	Yes	No
8 CHECK HARNESS BETWEEN AIRBAG CONTROL MODULE AND DATA LINK CONNECTOR. 1) Turn the ignition switch to OFF, disconnect the battery ground cable, and wait more than 20 seconds. 2) Disconnect the connector (AB3) from the airbag control module. 3) Connect the connector (1U) in test harness U to connector (AB3). 4) Measure the resistance between connector (4U) in test harness U and the data link connector. <i>Connector & terminal</i> <i>(4U) No. 18 — (B40) No. 10:</i>	Is the resistance less than 10 Ω ?	Go to step 9.	Repair the harness between airbag control module and data link connector. Or, replace the airbag main harness with body harness.
9 CHECK POWER SUPPLY CIRCUIT. 1) Turn the ignition switch to ON. 2) Measure the voltage between connector (2U) in test harness U and the chassis ground. <i>Connector & terminal</i> <i>(2U) No. 1 (+) — Chassis ground (-):</i> <i>(2U) No. 6 (+) — Chassis ground (-):</i>	Is the voltage more than 10 V?	Go to step 10.	Repair the harness between airbag control module and battery. Or, replace the airbag main harness with body harness.
10 CHECK BETWEEN AIRBAG CONTROL MODULE AND CHASSIS GROUND. 1) Turn the ignition switch to OFF. 2) Measure the resistance between connector (2U) in test harness U and chassis ground. <i>Connector & terminal</i> <i>(2U) No. 10 — Chassis ground:</i> <i>(2U) No. 11 — Chassis ground:</i>	Is the resistance less than 10 Ω ?	Go to step 11.	Repair the harness between airbag control module and chassis ground. Or, replace the airbag main harness with body harness.
11 CHECK POOR CONTACT IN CONNECTOR.	Is there poor contact in control module power supply, ground line and data link connector?	Repair the connector. (Airbag system connector must be replaced with harness. Do not attempt to repair it.)	Replace the airbag control module only. <Ref. to AB-18, REMOVAL, Airbag Control Module.>

2. WITHOUT DTC

DETECTING CONDITION:

- Defective combination meter
- Open circuit of harness

TROUBLE SYMPTOM:

- Airbag warning light does not go off.
- “NO TROUBLE CODE” displayed on the Subaru Select Monitor.

For detailed operation procedure, refer to «Airbag Warning Light Failure». <Ref. to AB(diag)-37, Airbag Warning Light Failure.>

NOTE:

- For detailed operation procedure, refer to «Airbag Warning Light Failure». <Ref. to AB(diag)-37, Airbag Warning Light Failure.>
- When the airbag warning light is OFF and “NO TROUBLE CODE” is displayed on Subaru Select Monitor, the system is in normal condition.

8. Airbag Warning Light Illumination Pattern

A: INSPECTION

Keep the ignition switch to ON, and confirm that the airbag warning light remains off after being turned on for approx. 6 seconds.

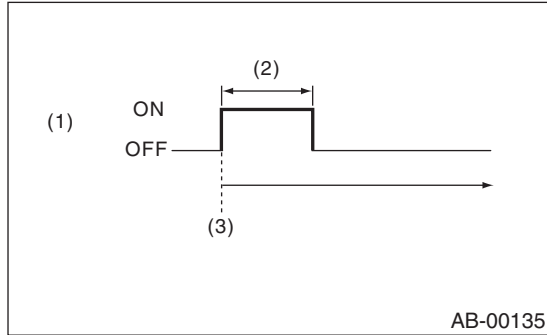

- (1) Airbag warning light
- (2) Approx. 6 seconds
- (3) Ignition switch ON

Read Diagnostic Trouble Code (DTC)

AIRBAG SYSTEM (DIAGNOSTICS)

9. Read Diagnostic Trouble Code (DTC)

A: OPERATION

For details about reading of DTCs, refer to “Subaru Select Monitor”. <Ref. to AB(diag)-28, Subaru Select Monitor.>

10. Inspection Mode

A: PROCEDURE

Recreate the circumstance by referring to the conditions described in the checklist.

11. Clear Memory Mode

A: OPERATION

Clear the memory in the following steps after the malfunction is repaired.

Detail procedure for clearing DTCs, refer to “Subaru Select Monitor”. <Ref. to AB(diag)-28, Subaru Select Monitor.>

12. Airbag Warning Light Failure

A: AIRBAG WARNING LIGHT REMAINS ON

DIAGNOSIS:

- Airbag warning light unit is faulty.
- Airbag control module to airbag warning light circuit is shorted or open.
- Grounding circuit is faulty.
- Airbag control module is faulty.
- (AB1) and (B31) are not connected properly.
- (AB3) is not connected properly to the airbag control module.

CAUTION:

- Before diagnosing the airbag system, be sure to turn the ignition switch to OFF, disconnect the ground cable from battery, and wait more than 20 seconds before starting to work.
- Before replacing the airbag module, seat belt pretensioner, roll connector, control module, and sensor, reconnect each part and confirm that the warning light operates properly.
- When inspecting the airbag main harness, disconnect the airbag module connector of the driver and passenger seats for safety reasons.

Airbag Warning Light Failure

AIRBAG SYSTEM (DIAGNOSTICS)

WIRING DIAGRAM:

- Auto A/C model

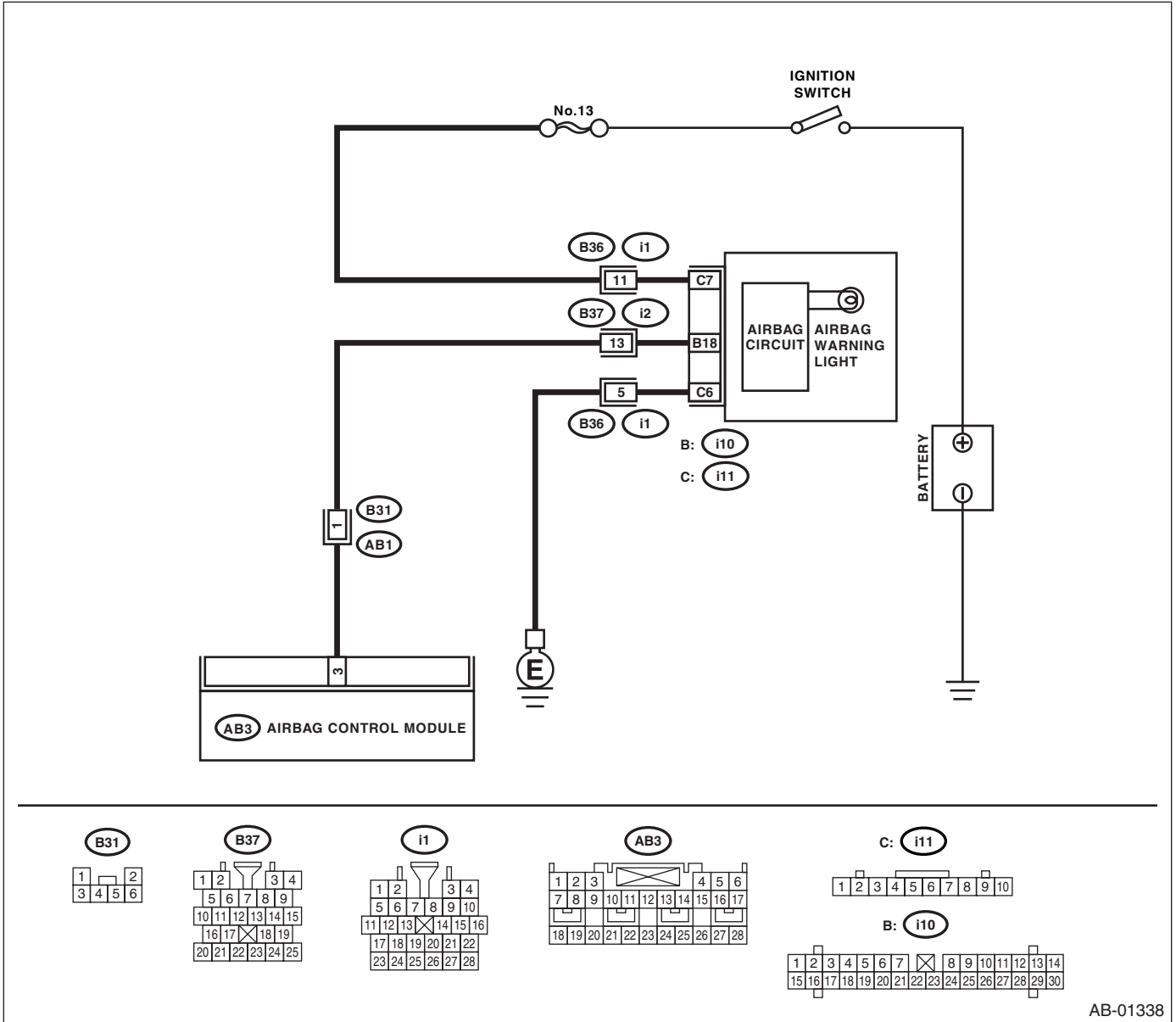

AB-01338

Airbag Warning Light Failure

AIRBAG SYSTEM (DIAGNOSTICS)

- Manual A/C model

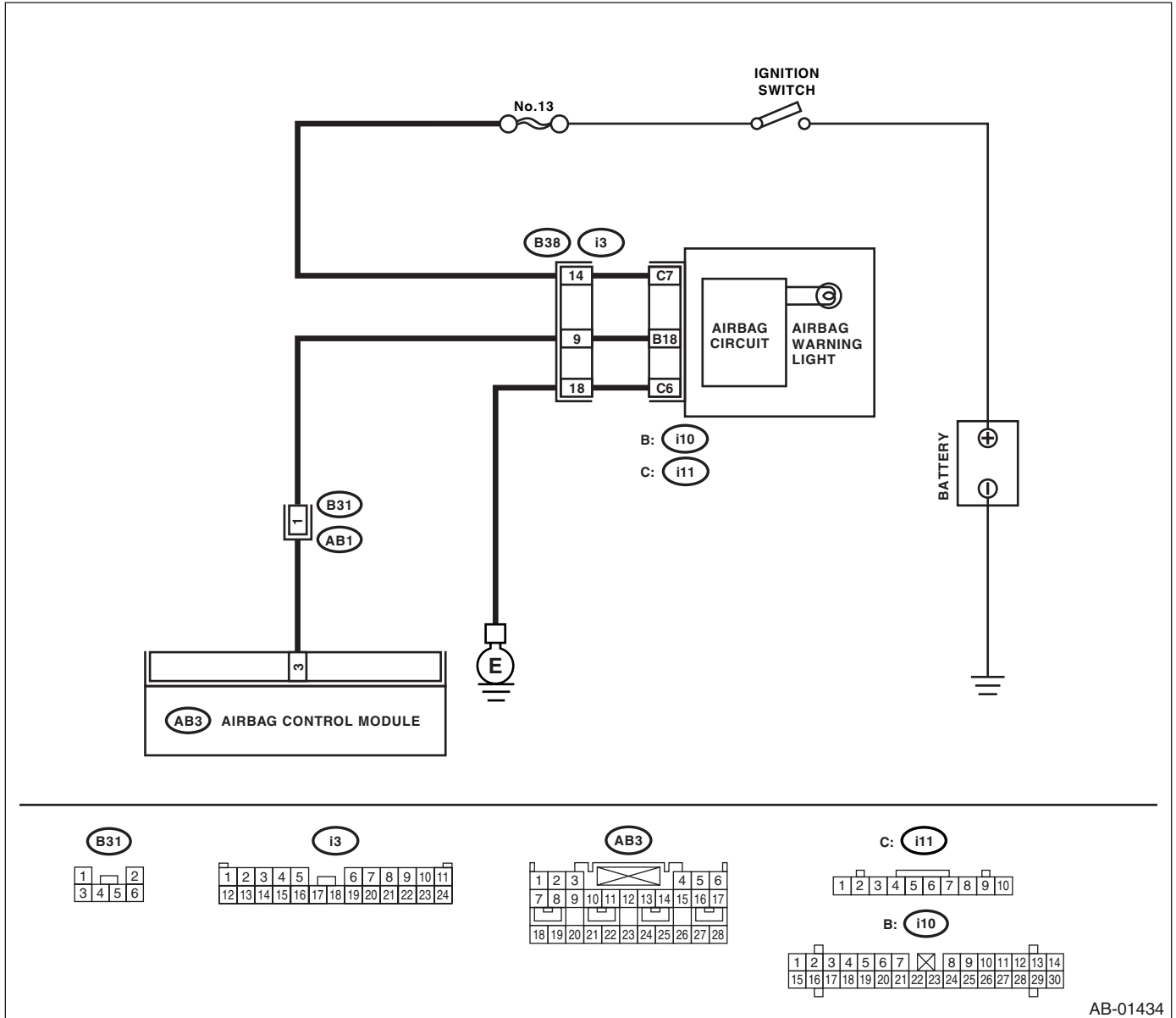

AB-01434

Airbag Warning Light Failure

AIRBAG SYSTEM (DIAGNOSTICS)

Step	Check	Yes	No
1 READ DTC. Read the DTC. <Ref. to AB(diag)-28, READ DIAGNOSTIC TROUBLE CODE (DTC), OPERATION, Subaru Select Monitor.>	Is the DTC displayed?	Perform the diagnosis according to DTC.	Go to step 2.
2 CHECK POOR CONTACT. 1) Turn the ignition switch to OFF, disconnect the battery ground cable, and wait more than 20 seconds. 2) Check that firm contact between the airbag control module and the connector (AB3) is secured.	Is there poor contact in connector (AB3)?	If the poor contact in connector is not corrected, replace the airbag main harness with body harness, or replace the airbag control module. <Ref. to AB-18, Airbag Control Module.>	Go to step 3.
3 CHECK AIRBAG MAIN HARNESS. 1) Remove the instrument panel lower cover and disconnect the connectors (AB26) and (AB21). 2) Remove the console side cover lower on passenger side and disconnect the connectors (AB27) and (AB4). 3) Disconnect the connector (AB3) from the airbag control module, and connect the connector (1R) in test harness R. 4) Connect the battery ground cable, and turn the ignition switch to ON. 5) Connect the connectors (5R) and (6R) in test harness R. NOTE: After problem has been eliminated, disconnect the connectors (5R) and (6R).	Does the airbag warning light go off?	Go to step 4.	Go to step 5.
4 CHECK GROUND CIRCUIT. 1) Turn the ignition switch to OFF, disconnect the battery ground cable, and wait more than 20 seconds. 2) Disconnect the connector (AB3) from the airbag control module. 3) Connect the connector (1R) in test harness R to body harness connector (AB3). 4) Measure the resistance between connector (2R) in test harness R and the chassis ground. Connector & terminal (2R) No. 10 — Chassis ground: (2R) No. 11 — Chassis ground:	Is the resistance less than 10 Ω ?	Replace the airbag control module. <Ref. to AB-18, Airbag Control Module.>	Repair the chassis ground circuit.
5 CHECK AIRBAG MAIN HARNESS. 1) Disconnect the connectors (5R) and (6R). 2) Remove the combination meter. 3) Measure the resistance between connector (i11) and (2R) in test harness R. Connector & terminal (2R) No. 7 — (i11) No. 8:	Is the resistance less than 10 Ω ?	Check the combination meter.	Go to step 6.
6 CHECK POOR CONTACT IN CONNECTORS (AB1) AND (B31). 1) Turn the ignition switch to OFF, disconnect the battery ground cable, and wait more than 20 seconds. 2) Confirm that firm contact between connectors (AB1) and (B31) is secured.	Is the poor contact in connectors (AB1) and (B31)?	Repair the body harness, or replace the airbag main harness with body harness.	Go to step 7.

Airbag Warning Light Failure

AIRBAG SYSTEM (DIAGNOSTICS)

	Step	Check	Yes	No
7	CHECK AIRBAG MAIN HARNESS. Check the airbag main harness for faults.	Is there any fault in the airbag main harness?	Replace the airbag main harness with body harness.	Repair the body harness.

Airbag Warning Light Failure

AIRBAG SYSTEM (DIAGNOSTICS)

B: AIRBAG WARNING LIGHT REMAINS OFF

DETECTING CONDITION:

- Fuse No. 13 (in fuse box) is blown.
- Body harness circuit is open.
- Airbag warning light is faulty.
- Airbag main harness is faulty.
- Airbag control module is faulty.

CAUTION:

- Before diagnosing the airbag system, be sure to turn the ignition switch to OFF, disconnect the ground cable from battery, and wait more than 20 seconds before starting to work.
- Before replacing the airbag module, seat belt pretensioner, roll connector, control module, and sensor, reconnect each part and confirm that the warning light operates properly.
- When inspecting the airbag main harness, disconnect the airbag module connector of the driver and passenger seats for safety reasons.

WIRING DIAGRAM:

- Auto A/C model

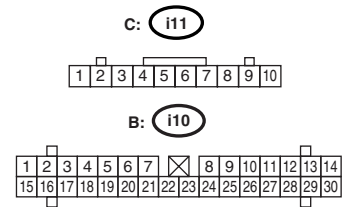
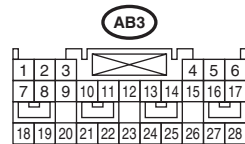
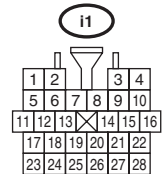
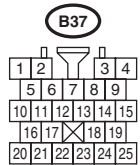
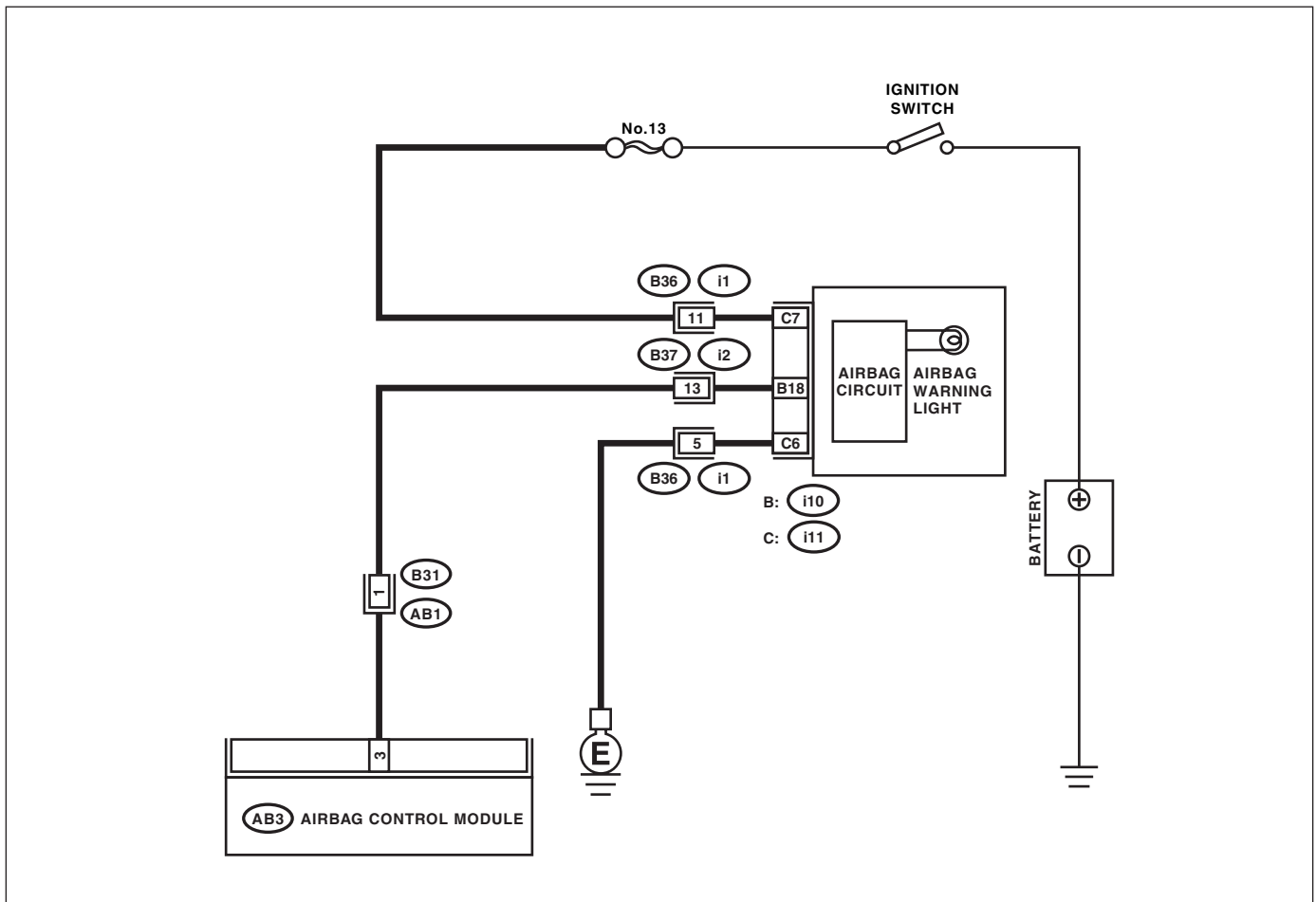

AB-01338

Airbag Warning Light Failure

AIRBAG SYSTEM (DIAGNOSTICS)

- Manual A/C model

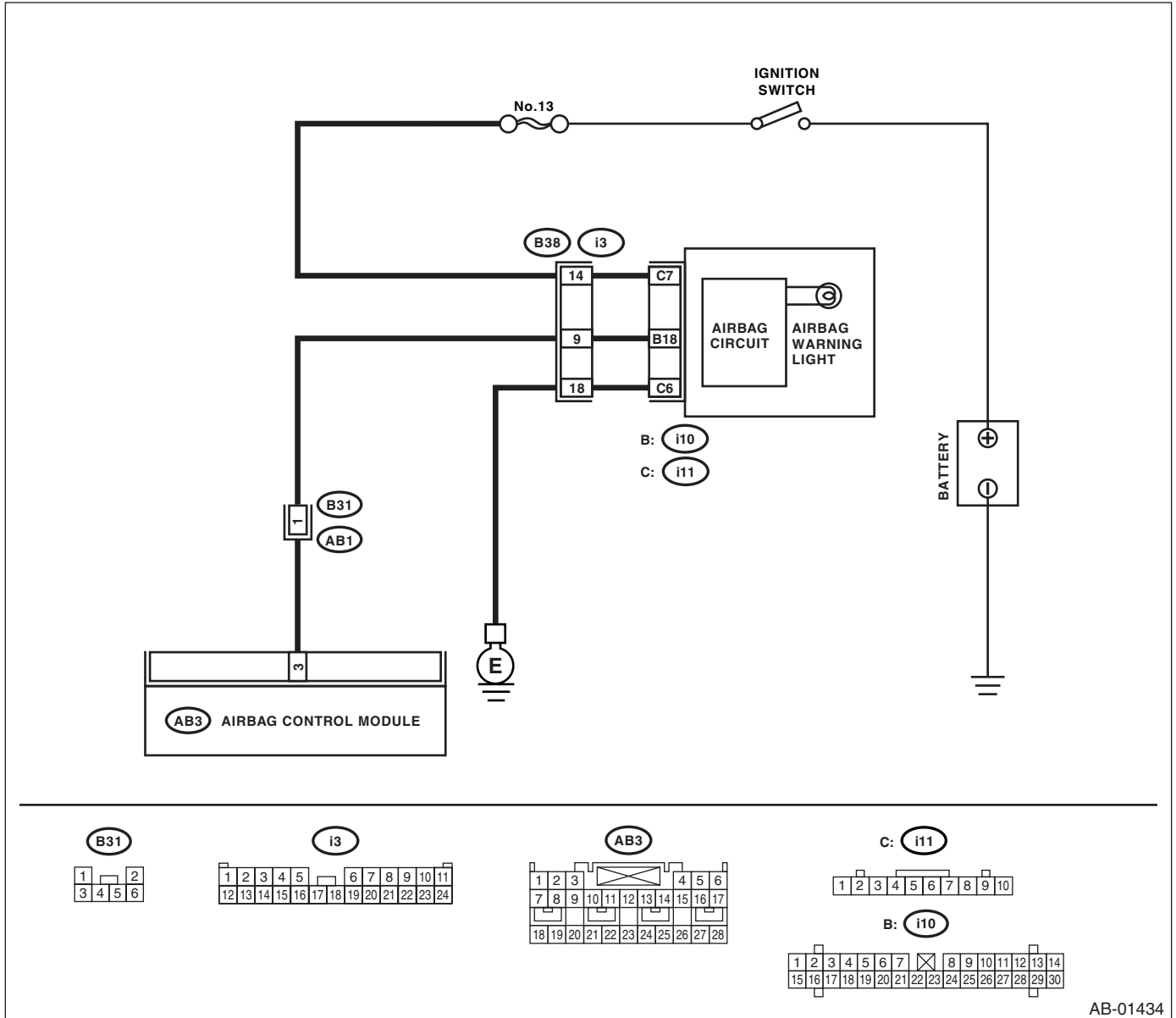

AB-01434

Airbag Warning Light Failure

AIRBAG SYSTEM (DIAGNOSTICS)

Step	Check	Yes	No
1 CHECK COMBINATION METER. Turn the ignition switch to ON, and confirm that warning lights in the combination meter are turned on.	Do the warning lights other than airbag turn on?	Go to step 2.	Repair the power supply line to combination meter. <Ref. to IDI-3, Combination Meter System.>
2 CHECK DTC. Read the DTC. <Ref. to AB(diag)-28, READ DIAGNOSTIC TROUBLE CODE (DTC), OPERATION, Subaru Select Monitor.>	Is the DTC displayed?	Perform the diagnosis according to DTC.	Go to step 3.
3 CHECK FUSE No. 13 (IN MAIN FUSE BOX). Remove the fuse No. 13 and perform visual inspection.	Is the fuse No. 13 (in main fuse box) blown out?	Replace the fuse No. 13. If fuse No. 13 is blown out again, go to step 3.	Go to step 4.
4 CHECK AIRBAG WARNING LIGHT CIRCUIT (IN COMBINATION METER). 1) Turn the ignition switch to OFF, disconnect the battery ground cable, and wait more than 20 seconds. 2) Disconnect the connector (AB1) from (B31). 3) Connect the battery ground cable, and turn the ignition switch to ON.	Is the airbag warning light turned on?	Go to step 5.	Replace the combination meter printed circuit. <Ref. to IDI-10, Combination Meter.>
5 CHECK AIRBAG MAIN HARNESS. 1) Turn the ignition switch to OFF, disconnect the battery ground cable, and wait more than 20 seconds. 2) Connect the connector (AB1) to (B31). 3) Disconnect the connector (AB3) from airbag control module. <Ref. to AB-18, Airbag Control Module.> 4) Connect the battery ground cable, and turn the ignition switch to ON.	Is the airbag warning light turned on?	Replace the airbag control module. <Ref. to AB-18, Airbag Control Module.>	Replace the airbag main harness with body harness.

List of Diagnostic Trouble Code (DTC)

AIRBAG SYSTEM (DIAGNOSTICS)

13. List of Diagnostic Trouble Code (DTC)

A: LIST

DTC	Display	Contents of diagnosis	Reference
11	Driver's Airbag failure	<ul style="list-style-type: none"> • Airbag main harness circuit is open, shorted or shorted to ground. • Airbag module harness (Driver) circuit is open, shorted or shorted to ground. • Roll connector circuit is open, shorted or shorted to ground. • Airbag control module is faulty. • Driver's airbag module is faulty. 	<Ref. to AB(diag)-49, DTC 11 DRIVER'S AIRBAG FAILURE, Diagnostic Chart with Trouble Code.>
12	Passenger's Airbag failure	<ul style="list-style-type: none"> • Airbag main harness circuit is open, shorted or shorted to ground. • Airbag module harness (Passenger) circuit is open, shorted or shorted to ground. • Airbag control module is faulty. • Passenger's airbag module is faulty. 	<Ref. to AB(diag)-53, DTC 12 PASSENGER'S AIRBAG FAILURE, Diagnostic Chart with Trouble Code.>
15	Driver's Airbag failure	<ul style="list-style-type: none"> • Airbag main harness circuit (Driver) is shorted to the power supply. • Airbag module harness (Driver) is shorted to the power supply. • Roll connector is shorted to the power supply. • Airbag control module is faulty. • Driver's airbag module is faulty. 	<Ref. to AB(diag)-56, DTC 15 DRIVER'S AIRBAG FAILURE, Diagnostic Chart with Trouble Code.>
16	Passenger's Airbag failure	<ul style="list-style-type: none"> • Airbag main harness circuit (Passenger) is shorted to the power supply. • Airbag module harness (Passenger) is shorted to the power supply. • Airbag control module is faulty. • Passenger's airbag module is faulty. 	<Ref. to AB(diag)-59, DTC 16 PASSENGER'S AIRBAG FAILURE, Diagnostic Chart with Trouble Code.>
21	Airbag ECU failure	Airbag control module is faulty.	<Ref. to AB(diag)-61, DTC 21 AIRBAG ECU FAILURE, Diagnostic Chart with Trouble Code.>
22	Front Airbag: Firing output	Front airbag module and seat belt pretensioner (LH/RH) are inflated.	<Ref. to AB(diag)-62, DTC 22 FRONT AIRBAG FIRING OUTPUT, Diagnostic Chart with Trouble Code.>
23	Connector to Airbag ECU failure	(AB3), (AB7) and (AB8) are not connected properly to airbag control module.	<Ref. to AB(diag)-63, DTC 23 CONNECTOR TO AIRBAG ECU, Diagnostic Chart with Trouble Code.>
24	IG1 open	<ul style="list-style-type: none"> • Airbag control module is faulty. • Airbag harness circuit is open. • Fuse No. 11 (in joint box) is blown. • Body harness circuit is open. 	<Ref. to AB(diag)-64, DTC 24 IG1 OPEN, Diagnostic Chart with Trouble Code.>
25	IG2 open	<ul style="list-style-type: none"> • Airbag control module is faulty. • Airbag main harness circuit is open. • Fuse No. 6 (in joint box) is blown. • Body harness circuit is open. 	<Ref. to AB(diag)-66, DTC 25 IG2 OPEN, Diagnostic Chart with Trouble Code.>
26	Passenger's Airbag indicator failure	<ul style="list-style-type: none"> • Passenger's airbag indicator is faulty. • Airbag control module is faulty. • Airbag main harness circuit is open, shorted or shorted to ground. • Open circuit of body harness. 	<Ref. to AB(diag)-68, DTC 26 PASSENGER'S AIRBAG INDICATOR FAILURE, Diagnostic Chart with Trouble Code.>

List of Diagnostic Trouble Code (DTC)

AIRBAG SYSTEM (DIAGNOSTICS)

DTC	Display	Contents of diagnosis	Reference
27	ODS Communication Error	<ul style="list-style-type: none"> • Communication error with occupant detection control module. • Airbag rear harness circuit is open, shorted or shorted to ground and power supply. • Occupant detection harness (seat harness) is faulty. • Occupant detection system is faulty. • Airbag control module is faulty. 	<Ref. to AB(diag)-71, DTC 27 ODS COMMUNICATION ERROR, Diagnostic Chart with Trouble Code.>
29	ODS Failure	<ul style="list-style-type: none"> • Load cell sensor is faulty. • Occupant detection control module is faulty. • Occupant detection harness is faulty. • Fuse No. 6 (in joint box) is blown. 	For details concerning DTC 29, refer to "Occupant Detection System". <Ref. to OD(diag)-30, DTC 29 ODS FAILURE, Diagnostic Procedure with Diagnostic Trouble Code (DTC).>
2A	ODS Calibration Error	The system calibration (Rezeroing) for occupant detection system is not completed successfully.	For details concerning DTC 2A, refer to "Occupant Detection System". <Ref. to OD(diag)-27, DTC 2A ODS CALIBRATION ERROR, Diagnostic Procedure with Diagnostic Trouble Code (DTC).>
2B	ODS System Wrong Parts	<ul style="list-style-type: none"> • Airbag control module is wrong parts. • Occupant detection system is wrong parts. • Occupant detection system is faulty. 	For details concerning DTC 2B, refer to "Occupant Detection System". <Ref. to OD(diag)-27, DTC 2B ODS SYSTEM WRONG PARTS, Diagnostic Procedure with Diagnostic Trouble Code (DTC).>
2C	Belt Tension Sensor Failure	<ul style="list-style-type: none"> • Passenger's belt tension sensor malfunction • Occupant detection system is faulty. • Side airbag rear harness circuit is open or shorted. • Occupant detection harness is faulty. 	For details concerning DTC 2C, refer to "Occupant Detection System". <Ref. to OD(diag)-28, DTC 2C BELT PRETENSIONER FAILURE, Diagnostic Procedure with Diagnostic Trouble Code (DTC).>
31	Front Sub Sensor RH failure	<ul style="list-style-type: none"> • Airbag main harness is open, shorted or shorted to power supply. • Front sub sensor (RH) is faulty. • Airbag control module is faulty. 	<Ref. to AB(diag)-74, DTC 31 FRONT SUB SENSOR RH FAILURE, Diagnostic Chart with Trouble Code.>
32	Front Sub Sensor LH failure	<ul style="list-style-type: none"> • Airbag main harness is open, shorted or shorted to power supply. • Front sub-sensor (LH) is faulty. • Airbag control module is faulty. 	<Ref. to AB(diag)-76, DTC 32 FRONT SUB SENSOR LH FAILURE, Diagnostic Chart with Trouble Code.>
33	Front Sub Sensor RH failure	Front sub sensor (RH) is faulty.	<Ref. to AB(diag)-78, DTC 33 FRONT SUB SENSOR RH FAILURE, Diagnostic Chart with Trouble Code.>
34	Front Sub Sensor LH failure	Front sub sensor (RH) is faulty.	<Ref. to AB(diag)-78, DTC 34 FRONT SUB SENSOR LH FAILURE, Diagnostic Chart with Trouble Code.>

List of Diagnostic Trouble Code (DTC)

AIRBAG SYSTEM (DIAGNOSTICS)

DTC	Display	Contents of diagnosis	Reference
36	Seat Position sensor LH failure	<ul style="list-style-type: none"> • Driver's seat position sensor is faulty. • Airbag control module is faulty. • Side airbag rear harness circuit is open, shorted or shorted to ground. 	<Ref. to AB(diag)-79, DTC 36 SEAT POSITION SENSOR LH FAILURE, Diagnostic Chart with Trouble Code.>
37	Buckle Switch RH failure	<ul style="list-style-type: none"> • Passenger's buckle switch circuit is open, shorted or shorted to ground. • Occupant detection system is faulty. • Occupant detection harness is faulty. 	For details concerning DTC 37, refer to "Occupant Detection System". <Ref. to OD(diag)-31, DTC 37 BUCKLE SWITCH RH FAILURE, Diagnostic Procedure with Diagnostic Trouble Code (DTC).>
38	Buckle Switch LH failure	<ul style="list-style-type: none"> • Driver's buckle switch circuit is open, shorted or shorted to ground. • Side airbag rear harness circuit is open, shorted or shorted to ground. • Airbag control module is faulty. 	<Ref. to AB(diag)-81, DTC 38 BUCKLE SWITCH LH FAILURE, Diagnostic Chart with Trouble Code.>
41	Side Airbag RH failure	<ul style="list-style-type: none"> • Side airbag harness is faulty. • Side airbag module (RH) is faulty. • Airbag control module is faulty. 	<Ref. to AB(diag)-83, DTC 41 SIDE AIRBAG RH FAILURE, Diagnostic Chart with Trouble Code.>
42	Side Airbag LH failure	<ul style="list-style-type: none"> • Side airbag harness is faulty. • Side airbag module (LH) is faulty. • Airbag control module is faulty. 	<Ref. to AB(diag)-85, DTC 42 SIDE AIRBAG LH FAILURE, Diagnostic Chart with Trouble Code.>
45	Side Airbag RH failure	<ul style="list-style-type: none"> • Side airbag harness is shorted to power supply. • Side airbag module (RH) is faulty. • Airbag control module is faulty. 	<Ref. to AB(diag)-87, DTC 45 SIDE AIRBAG RH FAILURE, Diagnostic Chart with Trouble Code.>
46	Side Airbag LH failure	<ul style="list-style-type: none"> • Side airbag harness is shorted to power supply. • Side airbag module (LH) is faulty. • Airbag control module is faulty. 	<Ref. to AB(diag)-89, DTC 46 SIDE AIRBAG LH FAILURE, Diagnostic Chart with Trouble Code.>
51	Side Airbag Sensor RH failure	<ul style="list-style-type: none"> • Side airbag sensor (RH) is faulty. • Side airbag harness is faulty. • Airbag control module is faulty. 	<Ref. to AB(diag)-91, DTC 51 SIDE AIRBAG RH FAILURE, Diagnostic Chart with Trouble Code.>
52	Side Airbag Sensor LH failure	<ul style="list-style-type: none"> • Side airbag sensor (LH) is faulty. • Side airbag harness is faulty. • Airbag control module is faulty. 	<Ref. to AB(diag)-94, DTC 52 SIDE AIRBAG SENSOR LH FAILURE, Diagnostic Chart with Trouble Code.>
53	Side Airbag Sensor RH failure	Side airbag sensor (RH) is faulty.	<Ref. to AB(diag)-96, DTC 53 SIDE AIRBAG RH FAILURE, Diagnostic Chart with Trouble Code.>
54	Side Airbag Sensor LH failure	Side airbag sensor (LH) is faulty.	<Ref. to AB(diag)-96, DTC 54 SIDE AIRBAG SENSOR LH FAILURE, Diagnostic Chart with Trouble Code.>
55	Side/Curtain Airbag: Firing output	Side airbag module is operated.	<Ref. to AB(diag)-96, DTC 55 SIDE CURTAIN AIRBAG FIRING OUTPUT, Diagnostic Chart with Trouble Code.>

List of Diagnostic Trouble Code (DTC)

AIRBAG SYSTEM (DIAGNOSTICS)

DTC	Display	Contents of diagnosis	Reference
61	Belt Pretensioner RH failure	<ul style="list-style-type: none"> • Seat belt pretensioner (RH) circuit is open, shorted or shorted to ground. • Airbag control module is faulty. • Pretensioner is faulty. • Airbag harness is faulty. 	<Ref. to AB(diag)-97, DTC 61 BELT PRETENSIONER RH FAILURE, Diagnostic Chart with Trouble Code.>
62	Belt Pretensioner LH failure	<ul style="list-style-type: none"> • Seat belt pretensioner (LH) circuit is open, shorted or shorted to ground. • Airbag control module is faulty. • Pretensioner is faulty. • Airbag harness is faulty. 	<Ref. to AB(diag)-99, DTC 62 BELT PRETENSIONER LH FAILURE, Diagnostic Chart with Trouble Code.>
65	Belt Pretensioner RH failure	<ul style="list-style-type: none"> • Seat belt pretensioner (RH) circuit is shorted to the power supply. • Pretensioner is faulty. • Airbag harness is faulty. • Airbag control module is faulty. 	<Ref. to AB(diag)-101, DTC 65 BELT PRETENSIONER RH FAILURE, Diagnostic Chart with Trouble Code.>
66	Belt Pretensioner LH failure	<ul style="list-style-type: none"> • Seat belt pretensioner (LH) circuit is shorted to the power supply. • Pretensioner is faulty. • Airbag harness is faulty. • Airbag control module is faulty. 	<Ref. to AB(diag)-103, DTC 66 BELT PRETENSIONER LH FAILURE, Diagnostic Chart with Trouble Code.>
71	Driver's Airbag failure	<ul style="list-style-type: none"> • Airbag main harness circuit is open, shorted or shorted to ground. • Airbag module harness (Driver) circuit is open, shorted or shorted to ground. • Roll connector circuit is open, shorted or shorted to ground. • Airbag control module is faulty. • Driver's airbag module is faulty. 	<Ref. to AB(diag)-105, DTC 71 DRIVER'S AIRBAG FAILURE, Diagnostic Chart with Trouble Code.>
72	Passenger's Airbag failure	<ul style="list-style-type: none"> • Airbag main harness is open, shorted or shorted to ground. • Airbag module harness (Passenger) is open, shorted or shorted to ground. • Airbag control module is faulty. • Passenger's airbag module is faulty. 	<Ref. to AB(diag)-108, DTC 72 PASSENGER'S AIRBAG FAILURE, Diagnostic Chart with Trouble Code.>
75	Driver's Airbag failure	<ul style="list-style-type: none"> • Airbag main harness circuit (Driver) is shorted to the power supply. • Airbag module harness (Driver) is shorted to the power supply. • Roll connector is shorted to the power supply. • Airbag control module is faulty. • Driver's airbag module is faulty. 	<Ref. to AB(diag)-111, DTC 75 DRIVER'S AIRBAG FAILURE, Diagnostic Chart with Trouble Code.>
76	Passenger's Airbag failure	<ul style="list-style-type: none"> • Airbag main harness (Passenger) is shorted to power supply. • Airbag module harness (Passenger) is shorted to power supply. • Airbag control module is faulty. • Passenger's airbag module is faulty. 	<Ref. to AB(diag)-114, DTC 76 PASSENGER'S AIRBAG FAILURE, Diagnostic Chart with Trouble Code.>

14. Diagnostic Chart with Trouble Code

A: DTC 11 DRIVER'S AIRBAG FAILURE

DTC DETECTING CONDITION:

- Airbag main harness circuit is open, shorted or shorted to ground.
- Airbag module harness (Driver) circuit is open, shorted or shorted to ground.
- Roll connector circuit is open, shorted or shorted to ground.
- Driver's airbag module is faulty.
- Airbag control module is faulty.

CAUTION:

- **Before diagnosing the airbag system, be sure to turn the ignition switch to OFF, disconnect the ground cable from battery, and wait more than 20 seconds before starting to work.**
- **Before replacing the airbag module, seat belt pretensioner, roll connector, control module, and sensor, reconnect each part and confirm that the warning light operates properly.**
- **When inspecting the airbag main harness, disconnect the driver's airbag module and passenger's airbag module connectors for safety reasons.**

NOTE:

Prior to diagnosis, prepare two airbag resistors (98299PA040).

Diagnostic Chart with Trouble Code

AIRBAG SYSTEM (DIAGNOSTICS)

WIRING DIAGRAM:

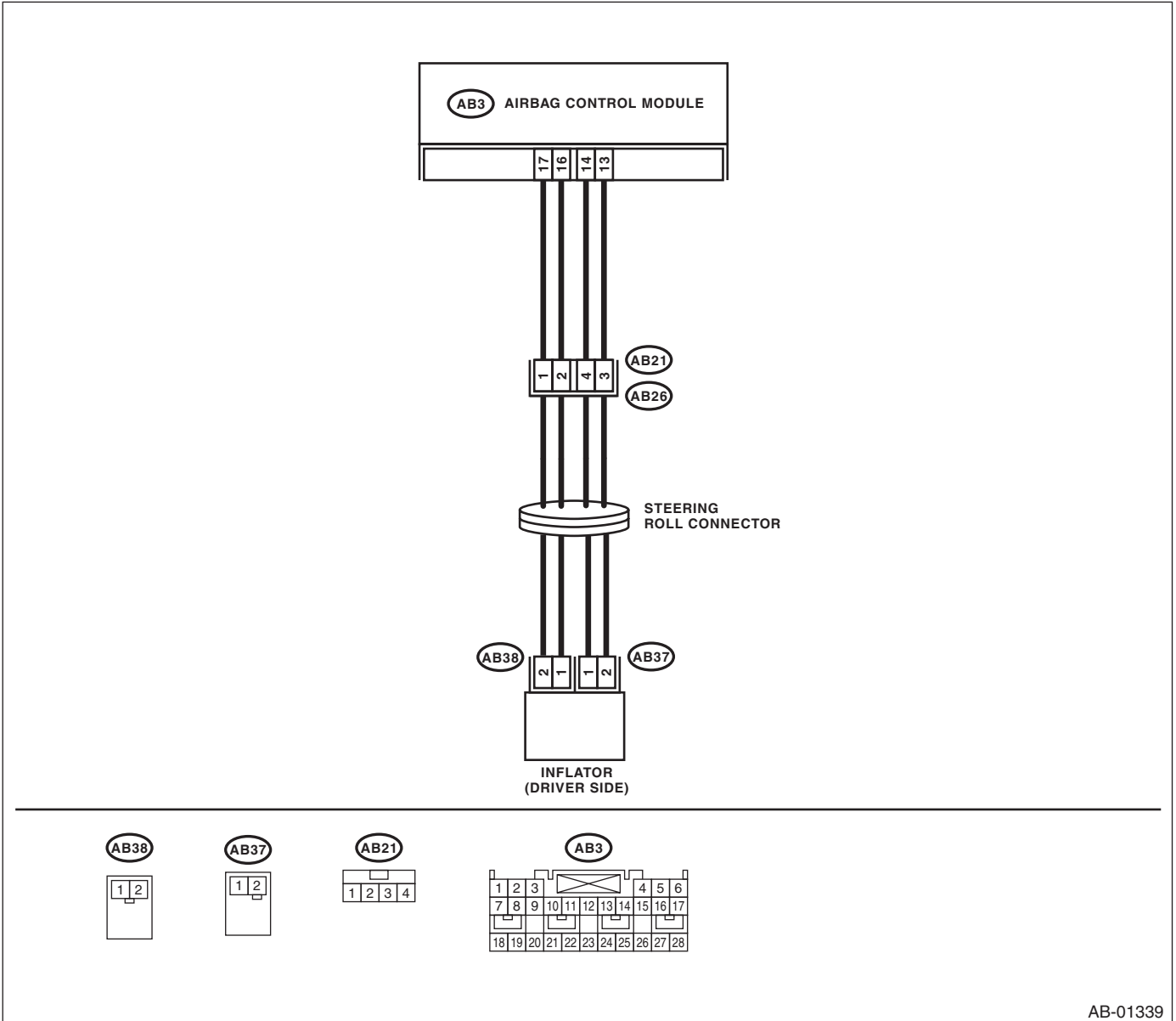

AB-01339

Diagnostic Chart with Trouble Code

AIRBAG SYSTEM (DIAGNOSTICS)

Step	Check	Yes	No
1 CHECK POOR CONTACT OF CONNECTORS. Check the connector between airbag control module and driver's airbag module for poor contact.	Is there poor contact?	Replace the airbag main harness.	Go to step 2.
2 CHECK DRIVER'S AIRBAG MODULE. 1) Turn the ignition switch to OFF, disconnect the battery ground cable, and wait more than 20 seconds. 2) Remove the driver's airbag module. 3) Connect the connector (1N) in test harness N to (AB38). 4) Connect the airbag resistor to the connector (2N) in test harness N. 5) Connect the connector (1Q) in test harness Q to connector (AB37). 6) Connect the airbag resistor to connector (2Q) in test harness Q. 7) Connect the battery ground cable, and turn the ignition switch to ON.	Does the airbag warning light illuminate for 6 seconds then go off?	Replace the driver's airbag module. <Ref. to AB-14, Driver's Airbag Module.>	Go to step 3.
3 CHECK ROLL CONNECTOR. 1) Turn the ignition switch to OFF, disconnect the battery ground cable, and wait more than 20 seconds. 2) Disconnect the test harness N from the connector (AB38). 3) Disconnect the test harness Q from the connector (AB37). 4) Remove the instrument panel lower cover and disconnect the connector (AB26) from (AB21). 5) Connect the connector (1P) in test harness P to connector (AB21). 6) Connect the airbag resistor to connectors (2P) and (3P) in test harness P. 7) Connect the battery ground cable, and turn the ignition switch to ON.	Does the airbag warning light illuminate for 6 seconds then go off?	Replace the roll connector. <Ref. to AB-20, Roll Connector.>	Go to step 4.
4 CHECK AIRBAG MAIN HARNESS (DRIVER'S AIRBAG HARNESS). 1) Turn the ignition switch to OFF, disconnect the battery ground cable, and wait more than 20 seconds. 2) Disconnect the airbag resistor from connectors (2P) and (3P) in test harness P. 3) Remove the instrument panel side cover on passenger side, and disconnect the connectors (AB4) and (AB27) from passenger's airbag module. 4) Disconnect the connector (AB3) from the airbag control module, and connect the connector (1R) in test harness R. 5) Measure the resistance between connector (2R) in test harness R and connectors (2P) and (3P) in test harness P. Connector & terminal (2R) No. 2 — (2P) No. 1: (2R) No. 4 — (2P) No. 2: (2R) No. 8 — (3P) No. 3: (2R) No. 12 — (3P) No. 4:	Is the resistance more than 10 Ω ?	Go to step 5.	Replace the airbag main harness with body harness.

Diagnostic Chart with Trouble Code

AIRBAG SYSTEM (DIAGNOSTICS)

Step	Check	Yes	No
5 CHECK AIRBAG MAIN HARNESS (DRIVER'S AIRBAG HARNESS). Measure the resistance of the connector (2R) terminals in test harness R. Connector & terminal <i>(2R) No. 2 — (2R) No. 4:</i> <i>(2R) No. 4 — Chassis ground:</i> <i>(2R) No. 2 — Chassis ground:</i> <i>(2R) No. 8 — (2R) No. 12:</i> <i>(2R) No. 8 — Chassis ground:</i> <i>(2R) No. 12 — Chassis ground:</i> <i>(2R) No. 2 — (2R) No. 8:</i> <i>(2R) No. 2 — (2R) No. 12:</i> <i>(2R) No. 4 — (2R) No. 8:</i> <i>(2R) No. 4 — (2R) No. 12:</i>	Is the resistance more than 1 MΩ?	Go to step 6.	Replace the airbag main harness with body harness.
6 CHECK AIRBAG CONTROL MODULE. 1) Connect all connectors. 2) Erase the memory. 3) Perform the inspection mode. 4) Read out the DTC.	Is the same DTC displayed?	Replace the airbag control module. <Ref. to AB-18, Airbag Control Module.>	Go to step 7.
7 CHECK FOR ANY OTHER DTC ON DISPLAY.	Is any other DTC displayed?	Using the List of Diagnostic Trouble Code (DTC), check the DTC. <Ref. to AB(diag)-45, List of Diagnostic Trouble Code (DTC).>	Finish the diagnosis.

Diagnostic Chart with Trouble Code

AIRBAG SYSTEM (DIAGNOSTICS)

B: DTC 12 PASSENGER'S AIRBAG FAILURE

DTC DETECTING CONDITION:

- Airbag main harness circuit is open, shorted or shorted to ground.
- Airbag module harness (Passenger) circuit is open, shorted or shorted to ground.
- Passenger's airbag module is faulty.
- Airbag control module is faulty.

CAUTION:

- Before diagnosing the airbag system, be sure to turn the ignition switch to OFF, disconnect the ground cable from battery, and wait more than 20 seconds before starting to work.
- Before replacing the airbag module, seat belt pretensioner, roll connector, control module, and sensor, reconnect each part and confirm that the warning light operates properly.
- When inspecting the airbag main harness, disconnect the airbag module connector of the driver and passenger seats for safety reasons.

WIRING DIAGRAM:

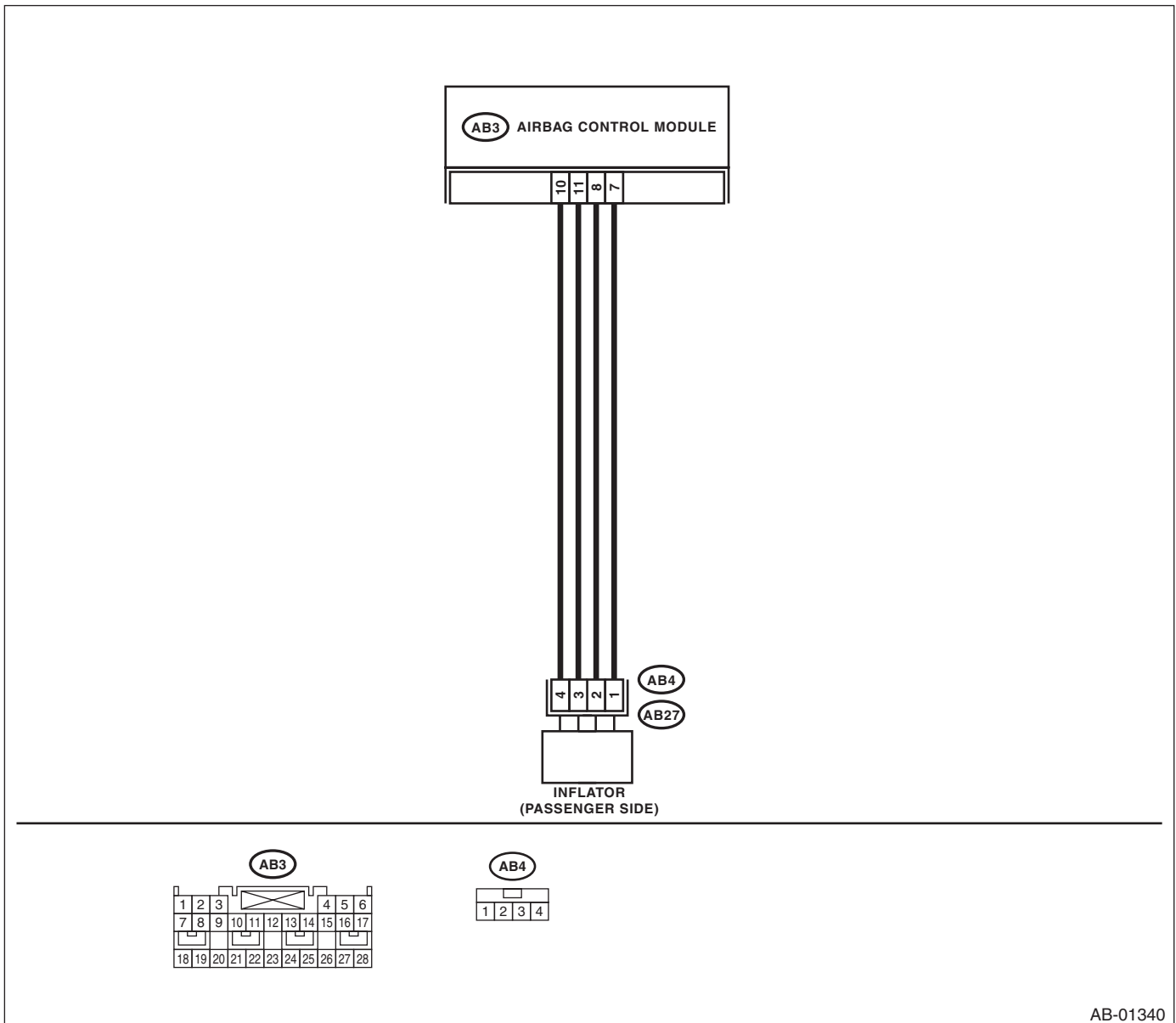

Diagnostic Chart with Trouble Code

AIRBAG SYSTEM (DIAGNOSTICS)

Step	Check	Yes	No
1 CHECK POOR CONTACT OF CONNECTORS. Check the connector between airbag control module and passenger's airbag module for poor contact.	Is there poor contact?	Replace the airbag main harness.	Go to step 2.
2 CHECK PASSENGER'S AIRBAG MODULE. 1) Turn the ignition switch to OFF, disconnect the battery ground cable, and wait more than 20 seconds. 2) Remove the instrument panel side cover of passenger's side. 3) Disconnect the connector (AB27) from (AB4). 4) Connect the connector (1P) in test harness P to connector (AB4). 5) Connect the airbag resistor to connectors (2P) and (3P) in test harness P. 6) Connect the battery ground cable, and turn the ignition switch to ON.	Does the airbag warning light illuminates for 6 seconds then go off?	Replace the passenger's airbag module. <Ref. to AB-15, Passenger's Airbag Module.>	Go to step 3.
3 CHECK AIRBAG MAIN HARNESS (PASSENGER'S AIRBAG HARNESS). 1) Turn the ignition switch to OFF, disconnect the battery ground cable, and wait more than 20 seconds. 2) Disconnect the airbag resistor from connectors (2P) and (3P) in test harness P. 3) Remove the instrument panel lower cover, and disconnect the connector (AB26) from (AB21). 4) Disconnect the connector (AB3) from the airbag control module, and connect the connector (1R) in test harness R. 5) Measure the resistance between connector (2R) in test harness R and connectors (2P) and (3P) in test harness P. Connector & terminal (2R) No. 3 — (2P) No. 2: (2R) No. 5 — (2P) No. 1: (2R) No. 9 — (3P) No. 3: (2R) No. 13 — (3P) No. 4:	Is the resistance less than 10 Ω ?	Go to step 4.	Replace the airbag main harness with body harness.
4 CHECK AIRBAG MAIN HARNESS (PASSENGER'S AIRBAG HARNESS). Measure the resistance between connector (2R) terminals in test harness R, and between connector (2R) and chassis ground. Connector & terminal (2R) No. 3 — (2R) No. 5: (2R) No. 3 — Chassis ground: (2R) No. 5 — Chassis ground: (2R) No. 9 — (2R) No. 13: (2R) No. 9 — Chassis ground: (2R) No. 13 — Chassis ground: (2R) No. 3 — (2R) No. 9: (2R) No. 3 — (2R) No. 13: (2R) No. 5 — (2R) No. 9: (2R) No. 5 — (2R) No. 13:	Is the resistance more than 1 M Ω ?	Go to step 5.	Replace the airbag main harness with body harness.

Diagnostic Chart with Trouble Code

AIRBAG SYSTEM (DIAGNOSTICS)

Step	Check	Yes	No
5 CHECK AIRBAG CONTROL MODULE. 1) Connect all connectors. 2) Erase the memory. 3) Perform the inspection mode. 4) Read out the DTC.	Is the same DTC displayed?	Replace the airbag control module. <Ref. to AB-18, Airbag Control Module.>	Go to step 6 .
6 CHECK FOR ANY OTHER DTC ON DISPLAY.	Is any other DTC displayed?	Using the List of Diagnostic Trouble Code (DTC), check the DTC. <Ref. to AB(diag)-45, List of Diagnostic Trouble Code (DTC).>	Finish the diagnosis.

Diagnostic Chart with Trouble Code

AIRBAG SYSTEM (DIAGNOSTICS)

C: DTC 15 DRIVER'S AIRBAG FAILURE

DTC DETECTING CONDITION:

- Airbag main harness circuit (Driver) is shorted to the power supply.
- Airbag module harness (Driver) is shorted to the power supply.
- Roll connector is shorted to the power supply.
- Driver's airbag module is faulty.
- Airbag control module is faulty.

CAUTION:

- Before diagnosing the airbag system, be sure to turn the ignition switch to OFF, disconnect the ground cable from battery, and wait more than 20 seconds before starting to work.
- Before replacing the airbag module, seat belt pretensioner, roll connector, control module, and sensor, reconnect each part and confirm that the warning light operates properly.
- When inspecting the airbag main harness, disconnect the driver's airbag module and passenger's airbag module connectors for safety reasons.

NOTE:

Prior to diagnosis, prepare two airbag resistors (98299PA040).

WIRING DIAGRAM:

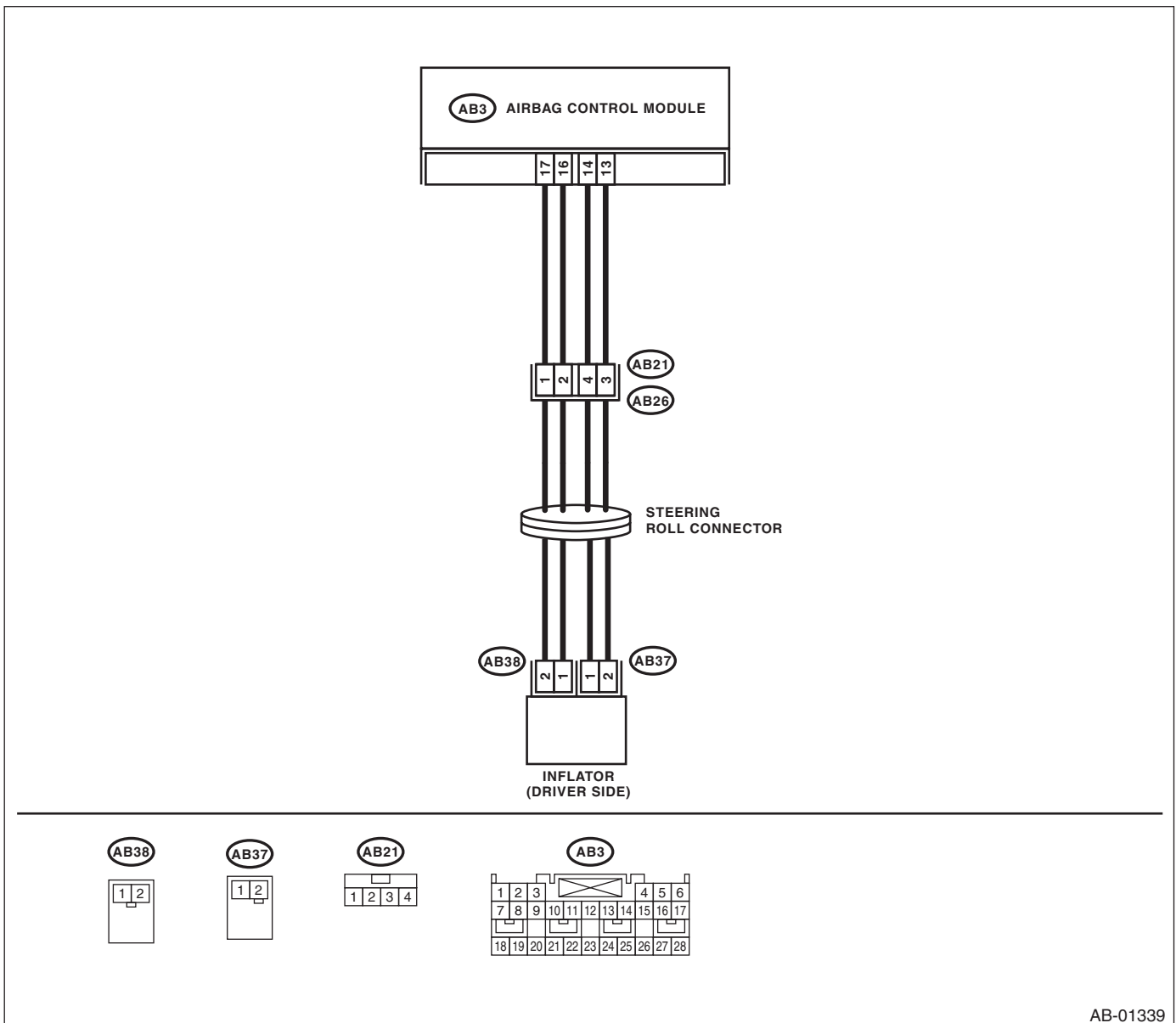

AB-01339

Diagnostic Chart with Trouble Code

AIRBAG SYSTEM (DIAGNOSTICS)

Step	Check	Yes	No
1 CHECK POOR CONTACT OF CONNECTORS. Check the connector between airbag control module and driver's airbag module for poor contact.	Is there poor contact?	Replace the airbag main harness.	Go to step 2.
2 CHECK DRIVER'S AIRBAG MODULE. 1) Turn the ignition switch to OFF, disconnect the battery ground cable, and wait more than 20 seconds. 2) Remove the driver's airbag module. 3) Connect the connector (AB38) to connector (1N) in test harness N. 4) Connect the airbag resistor to the connector (2N) in test harness N. 5) Connect the connector (1Q) in test harness Q to connector (AB37). 6) Connect the airbag resistor to connector (2Q) in test harness Q. 7) Connect the battery ground cable, and turn the ignition switch to ON.	Does the airbag warning light illuminate for 6 seconds then go off?	Replace the driver's airbag module. <Ref. to AB-14, Driver's Airbag Module.>	Go to step 3.
3 CHECK ROLL CONNECTOR. 1) Turn the ignition switch to OFF, disconnect the battery ground cable, and wait more than 20 seconds. 2) Disconnect the test harness N from connector (AB38). 3) Disconnect the test harness Q from connector (AB37). 4) Remove the instrument panel lower cover, and disconnect the connector (AB21) from (AB26). 5) Connect the connector (1P) in test harness P to connector (AB21). 6) Connect the airbag resistor to connectors (2P) and (3P) in test harness P. 7) Connect the battery ground cable, and turn the ignition switch to ON.	Does the airbag warning light illuminate for 6 seconds then go off?	Replace the roll connector. <Ref. to AB-20, Roll Connector.>	Go to step 4.
4 CHECK AIRBAG MAIN HARNESS (DRIVER'S AIRBAG HARNESS). 1) Turn the ignition switch to OFF, disconnect the battery ground cable, and wait more than 20 seconds. 2) Disconnect the airbag resistor from connectors (2P) and (3P) in test harness P. 3) Remove the instrument panel side cover on passenger side, and disconnect the connectors (AB27) and (AB4). 4) Disconnect the connector (AB3) from the airbag control module, and connect the connector (1R) in test harness R. 5) Connect the battery ground cable, and turn the ignition switch to ON. (engine OFF) 6) Measure the voltage between connector (2R) in test harness R and the chassis ground. Connector & terminal (2R) No. 4 (+) — Chassis ground (-): (2R) No. 2 (+) — Chassis ground (-): (2R) No. 8 (+) — Chassis ground (-): (2R) No. 12 (+) — Chassis ground (-):	Is the voltage less than 1 V?	Go to step 5.	Replace the airbag main harness with body harness.

Diagnostic Chart with Trouble Code

AIRBAG SYSTEM (DIAGNOSTICS)

Step	Check	Yes	No
5 CHECK AIRBAG CONTROL MODULE. 1) Connect all connectors. 2) Erase the memory. 3) Perform the inspection mode. 4) Read out the DTC.	Is the same DTC displayed?	Replace the airbag control module. <Ref. to AB-18, Airbag Control Module.>	Go to step 6 .
6 CHECK FOR ANY OTHER DTC ON DISPLAY.	Is any other DTC displayed?	Using the List of Diagnostic Trouble Code (DTC), check the DTC. <Ref. to AB(diag)-45, List of Diagnostic Trouble Code (DTC).>	Finish the diagnosis.

Diagnostic Chart with Trouble Code

AIRBAG SYSTEM (DIAGNOSTICS)

D: DTC 16 PASSENGER'S AIRBAG FAILURE

DTC DETECTING CONDITION:

- Airbag main harness circuit (Passenger) is shorted to the power supply.
- Airbag module harness (Passenger) is shorted to the power supply.
- Passenger's airbag module is faulty.
- Airbag control module is faulty.

CAUTION:

- Before diagnosing the airbag system, be sure to turn the ignition switch to OFF, disconnect the ground cable from battery, and wait more than 20 seconds before starting to work.
- Before replacing the airbag module, seat belt pretensioner, roll connector, control module, and sensor, reconnect each part and confirm that the warning light operates properly.
- When inspecting the airbag main harness, disconnect the airbag module connector of the driver and passenger seats for safety reasons.

WIRING DIAGRAM:

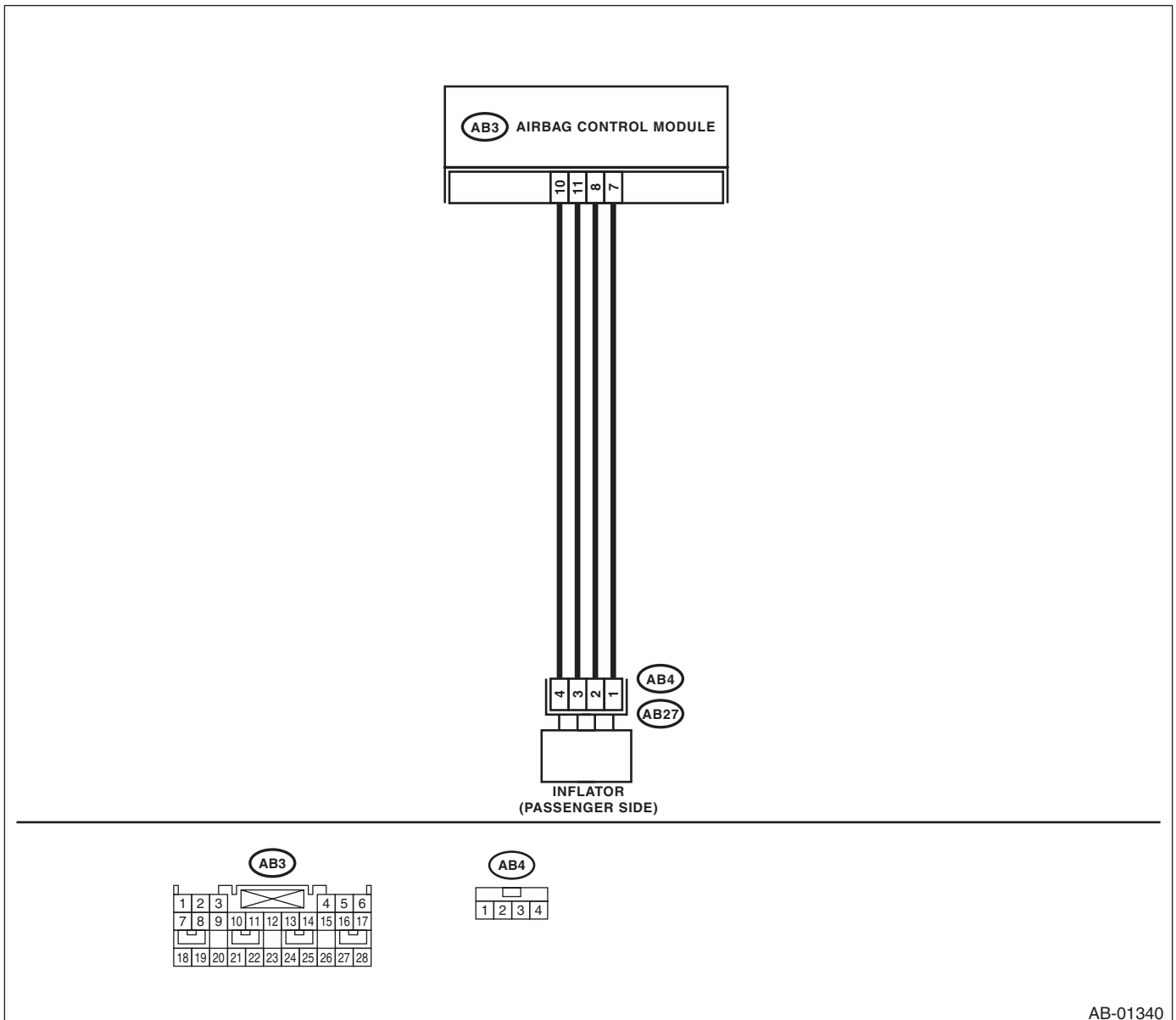

AB-01340

Diagnostic Chart with Trouble Code

AIRBAG SYSTEM (DIAGNOSTICS)

Step	Check	Yes	No
1 CHECK POOR CONTACT OF CONNECTORS. Check the connector between airbag control module and passenger's airbag module for poor contact.	Is there poor contact?	Replace the airbag main harness with body harness.	Go to step 2.
2 CHECK PASSENGER'S AIRBAG MODULE. 1) Turn the ignition switch to OFF, disconnect the battery ground cable, and wait more than 20 seconds. 2) Remove the instrument panel side cover of passenger's side. 3) Disconnect the connector (AB27) from (AB4) 4) Connect the connector (1P) in test harness P to connector (AB4). 5) Connect the airbag resistor to connectors (2P) and (3P) in test harness P. 6) Connect the battery ground cable, and turn the ignition switch to ON.	Does the airbag warning light illuminates for 6 seconds then go off?	Replace the passenger's airbag module. <Ref. to AB-15, Passenger's Airbag Module.>	Go to step 3.
3 CHECK AIRBAG MAIN HARNESS (PASSENGER'S AIRBAG HARNESS). 1) Turn the ignition switch to OFF, disconnect the battery ground cable, and wait more than 20 seconds. 2) Disconnect the airbag resistor from connectors (2P) and (3P) in test harness P. 3) Remove the instrument panel lower cover and disconnect the connector (AB26) from (AB21). 4) Disconnect the connector (AB3) from the airbag control module, and connect the connector (1R) in test harness R. 5) Measure the voltage between connector (2R) in test harness R and chassis ground. Connector & terminal (2R) No. 3 (+) — Chassis ground (-): (2R) No. 5 (+) — Chassis ground (-): (2R) No. 9 (+) — Chassis ground (-): (2R) No. 13 (+) — Chassis ground (-):	Is the voltage less than 1 V?	Go to step 4.	Replace the airbag main harness with body harness.
4 CHECK AIRBAG CONTROL MODULE. 1) Connect all connectors. 2) Erase the memory. 3) Perform the inspection mode. 4) Read out the DTC.	Is the same DTC displayed?	Replace the airbag control module. <Ref. to AB-18, Airbag Control Module.>	Go to step 5.
5 CHECK FOR ANY OTHER DTC ON DISPLAY.	Is any other DTC displayed?	Using the List of Diagnostic Trouble Code (DTC), check the DTC. <Ref. to AB(diag)-45, List of Diagnostic Trouble Code (DTC).>	Finish the diagnosis.

Diagnostic Chart with Trouble Code

AIRBAG SYSTEM (DIAGNOSTICS)

E: DTC 21 AIRBAG ECU FAILURE

DTC DETECTING CONDITION:

Airbag control module is faulty.

CAUTION:

- Before diagnosing the airbag system, be sure to turn the ignition switch to OFF, disconnect the ground cable from battery, and wait more than 20 seconds before starting to work.
- Before replacing the airbag module, seat belt pretensioner, roll connector, control module, and sensor, reconnect each part and confirm that the warning light operates properly.

	Step	Check	Yes	No
1	CHECK IF DTC 21 IS INDICATED. 1) Read the DTC. <Ref. to AB(diag)-28, READ DIAGNOSTIC TROUBLE CODE (DTC), OPERATION, Subaru Select Monitor.> 2) Perform the clear memory mode. <Ref. to AB(diag)-36, Clear Memory Mode.> 3) Read the DTC again.	Is the DTC 21 displayed?	Replace the airbag control module. <Ref. to AB-18, Airbag Control Module.>	A temporary poor contact.

Diagnostic Chart with Trouble Code

AIRBAG SYSTEM (DIAGNOSTICS)

F: DTC 22 FRONT AIRBAG FIRING OUTPUT WIRING DIAGRAM:

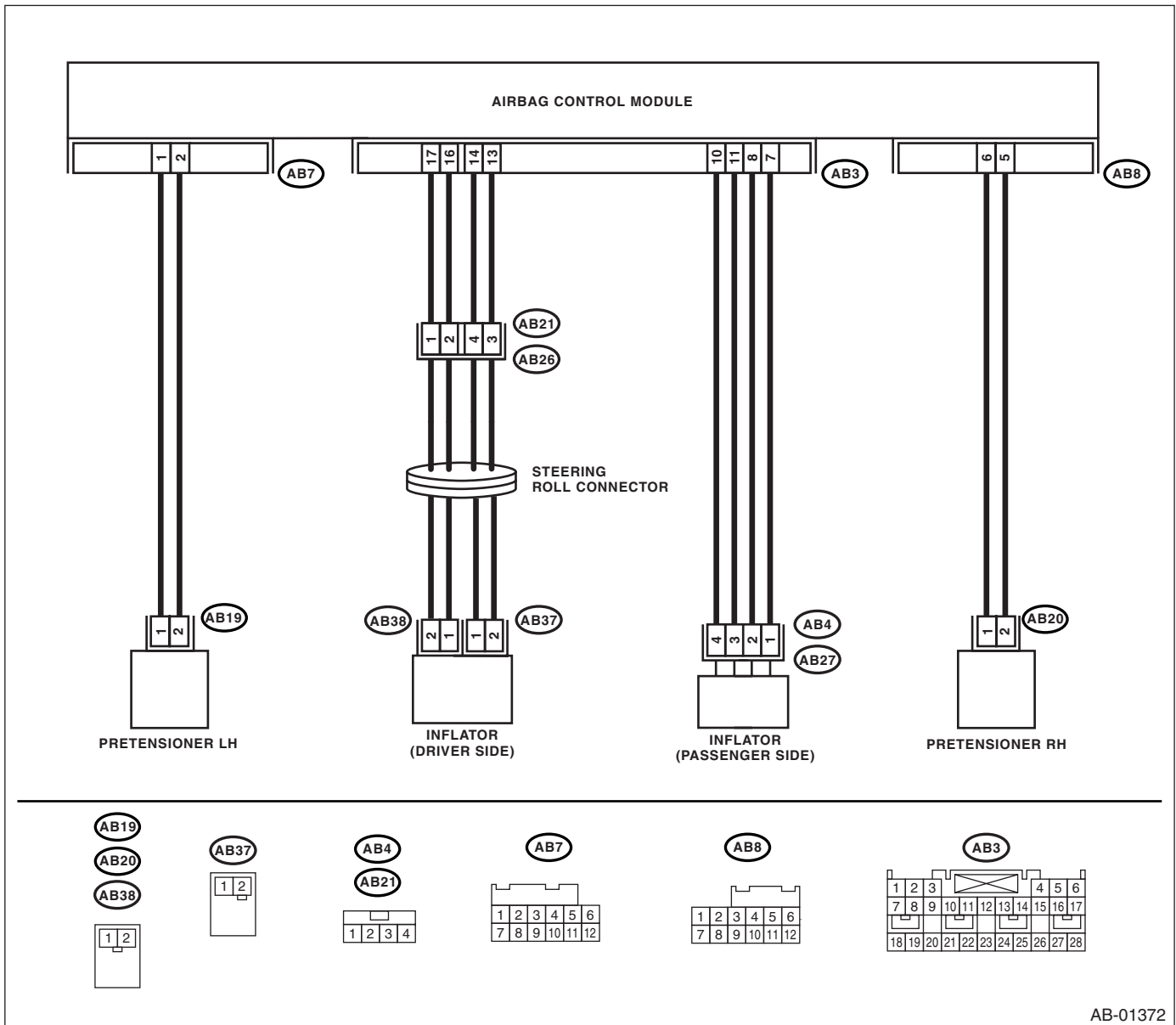

AB-01372

This DTC is indicated when the front airbag and the pretensioner are deployed.

Once this DTC is indicated, memory is not erasable; therefore replace the following parts.

- Airbag control module <Ref. to AB-18, Airbag Control Module.>
- Driver's airbag module <Ref. to AB-14, Driver's Airbag Module.>
- Passenger's airbag module <Ref. to AB-15, Passenger's Airbag Module.>
- Front sub sensor of both sides <Ref. to AB-21, Front Sub Sensor.>
- Front seat belt outer with pretensioner of both sides <Ref. to SB-10, Front Seat Belt.>

Diagnostic Chart with Trouble Code

AIRBAG SYSTEM (DIAGNOSTICS)

G: DTC 23 CONNECTOR TO AIRBAG ECU

DTC DETECTING CONDITION:

(AB3), (AB7) and (AB8) are not connected properly to airbag control module.

CAUTION:

Before diagnosing the airbag system, be sure to turn the ignition switch to OFF, disconnect the ground cable from battery, and wait more than 20 seconds before starting to work.

Step	Check	Yes	No
1 CHECK POOR CONTACT IN CONNECTORS (AB3), (AB7) AND (AB8). 1) Turn the ignition switch to OFF, disconnect the battery ground cable, and wait more than 20 seconds. 2) Disconnect the connectors (AB3), (AB7) and (AB8) from the airbag control module. <Ref. to AB-18, Airbag Control Module.>	Is there rust or damage appear on the harness connector and the control module connector?	Go to step 2.	Replace the airbag control module. <Ref. to AB-18, Airbag Control Module.>Replace the body harness with airbag main harness. Replace the body harness with side airbag harness.
2 CHECK POOR CONTACT IN CONNECTORS (AB3), (AB7) AND (AB8). 1) Ensure that connectors are firmly reconnected. 2) Connect the battery ground cable, and turn the ignition switch to ON.	Does the airbag warning light illuminate for 6 seconds then go off?	Go to step 3.	Replace the airbag control module. <Ref. to AB-18, Airbag Control Module.>
3 CHECK AIRBAG CONTROL MODULE. 1) Connect all connectors. 2) Erase the memory. 3) Perform the inspection mode. 4) Read out the DTC.	Is the same DTC displayed?	Replace the airbag control module. <Ref. to AB-18, Airbag Control Module.>	Go to step 4.
4 CHECK FOR ANY OTHER DTC ON DISPLAY.	Is any other DTC displayed?	Using the List of Diagnostic Trouble Code (DTC), check the DTC. <Ref. to AB(diag)-45, List of Diagnostic Trouble Code (DTC).>	Finish the diagnosis.

Diagnostic Chart with Trouble Code

AIRBAG SYSTEM (DIAGNOSTICS)

H: DTC 24 IG1 OPEN

DTC DETECTING CONDITION:

- Airbag control module is faulty.
- Airbag main harness circuit is open.
- Fuse No. 11 (in joint box) is blown.
- Body harness circuit is open.

CAUTION:

- Before diagnosing the airbag system, be sure to turn the ignition switch to OFF, disconnect the ground cable from battery, and wait more than 20 seconds before starting to work.
- Before replacing the airbag module, seat belt pretensioner, roll connector, control module, and sensor, reconnect each part and confirm that the warning light operates properly.
- When inspecting the airbag main harness, disconnect the driver's airbag module passenger's airbag module connectors for safety reasons.

WIRING DIAGRAM:

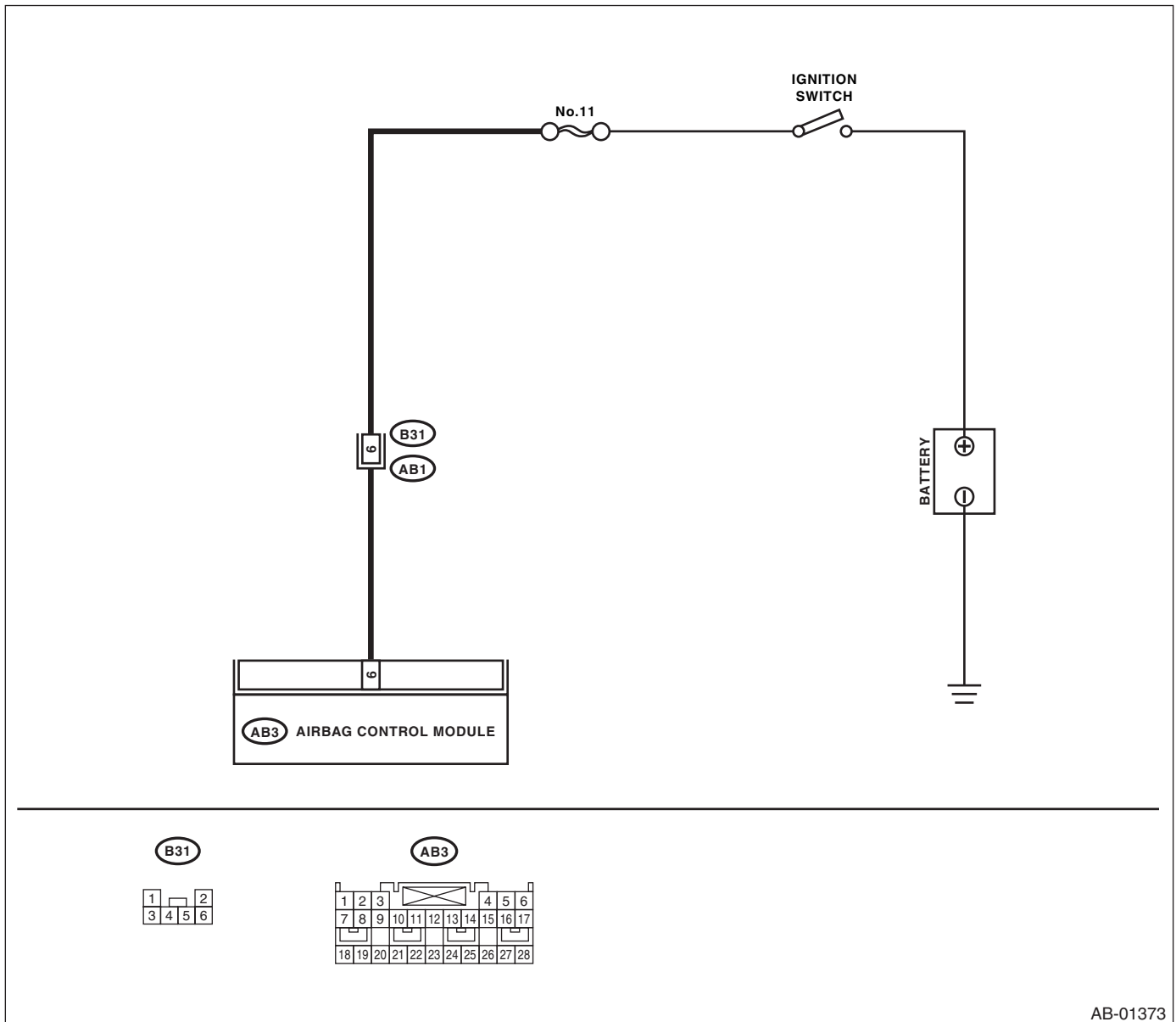

AB-01373

Diagnostic Chart with Trouble Code

AIRBAG SYSTEM (DIAGNOSTICS)

Step	Check	Yes	No
1 CHECK AIRBAG CONTROL MODULE. 1) Turn the ignition switch to OFF, disconnect the battery ground cable, and wait more than 20 seconds. 2) Disconnect the connector (AB3) from the airbag control module. 3) Connect the connector (1R) in test harness R to connector (AB3). 4) Connect the battery ground cable, and turn the ignition switch to ON. 5) Measure the voltage between connector (2R) in test harness R and chassis ground. Connector & terminal (2R) No. 1 (+) — Chassis ground (-):	Is the voltage more than 10 V?	Replace the airbag control module. <Ref. to AB-18, Airbag Control Module.>	Go to step 2.
2 CHECK FUSE No. 11 (IN JOINT BOX). 1) Confirm that the ignition switch is turned OFF. 2) Remove the fuse No. 11 (in joint box) and perform visual inspection.	Is the fuse No. 11 blown out?	Replace the fuse No. 11. If fuse No. 11 is blown out again, repair the body harness. Replace the airbag main harness with body harness.	Go to step 3.
3 CHECK AIRBAG CONTROL MODULE. 1) Connect all connectors. 2) Erase the memory. 3) Perform the inspection mode. 4) Read out the DTC.	Is the same DTC displayed?	Replace the airbag control module. <Ref. to AB-18, Airbag Control Module.>	Go to step 4.
4 CHECK FOR ANY OTHER DTC ON DISPLAY.	Is any other DTC displayed?	Using the List of Diagnostic Trouble Code (DTC), check the DTC. <Ref. to AB(diag)-45, List of Diagnostic Trouble Code (DTC).>	Finish the diagnosis.

Diagnostic Chart with Trouble Code

AIRBAG SYSTEM (DIAGNOSTICS)

I: DTC 25 IG2 OPEN

DTC DETECTING CONDITION:

- Airbag control module is faulty.
- Airbag main harness circuit is open.
- Fuse No. 6 (in joint box) is blown.
- Body harness circuit is open.

CAUTION:

- Before diagnosing the airbag system, be sure to turn the ignition switch to OFF, disconnect the ground cable from battery, and wait more than 20 seconds before starting to work.
- Before replacing the airbag module, seat belt pretensioner, roll connector, control module, and sensor, reconnect each part and confirm that the warning light operates properly.
- When inspecting the airbag main harness, disconnect the driver's airbag module and passenger's airbag module connectors for safety reasons.

WIRING DIAGRAM:

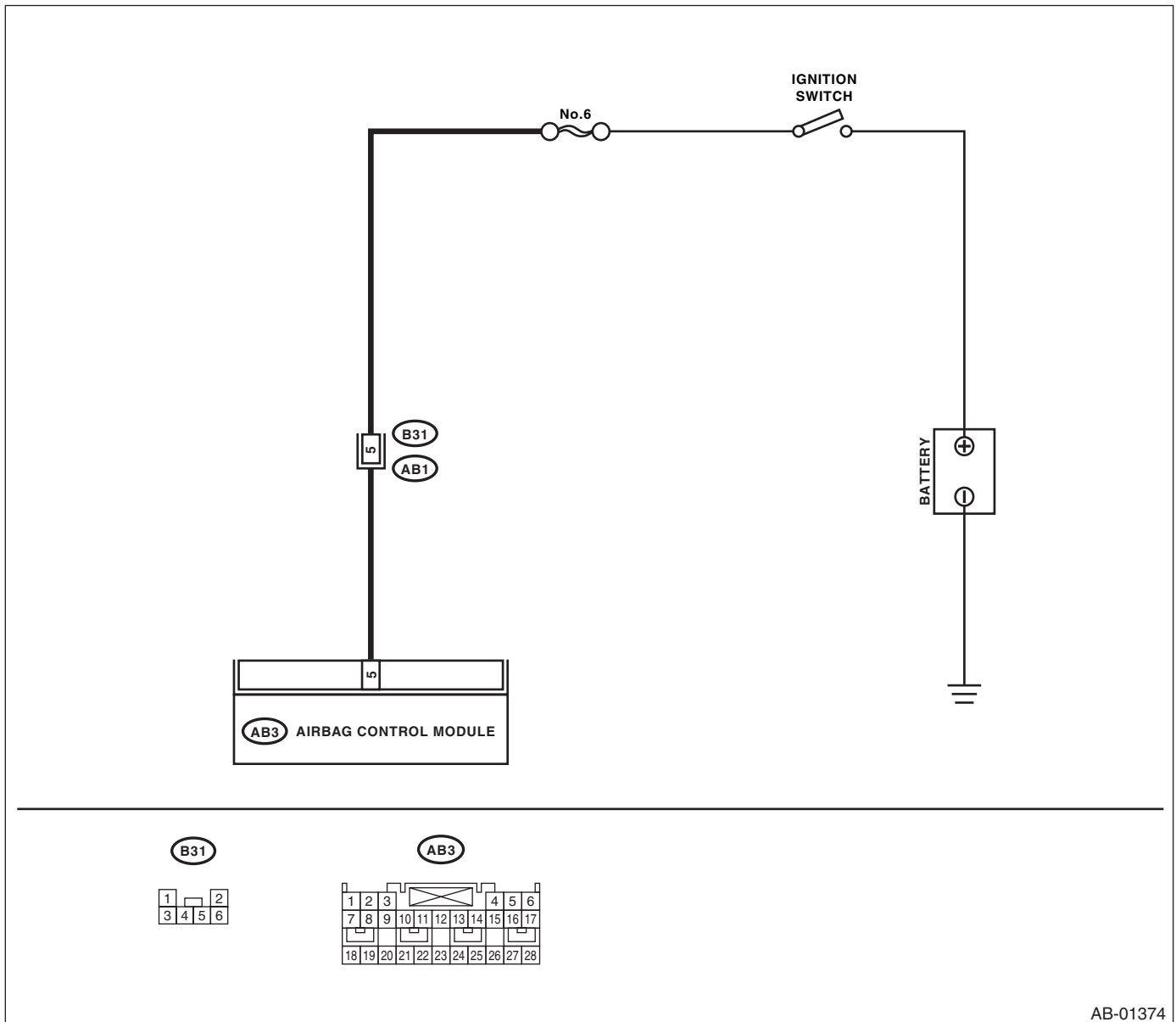

AB-01374

Diagnostic Chart with Trouble Code

AIRBAG SYSTEM (DIAGNOSTICS)

Step	Check	Yes	No
1 CHECK AIRBAG CONTROL MODULE. 1) Turn the ignition switch to OFF, disconnect the battery ground cable, and wait more than 20 seconds. 2) Disconnect the connector (AB3) from the airbag control module. 3) Connect the connector (1R) in test harness R to connector (AB3). 4) Connect the battery ground cable, and turn the ignition switch to ON. 5) Measure the voltage between connector (2R) in test harness R and chassis ground. Connector & terminal (2R) No. 6 (+) — Chassis ground (-):	Is the voltage more than 10 V?	Replace the airbag control module. <Ref. to AB-18, Airbag Control Module.>	Go to step 2.
2 CHECK FUSE No. 6 (IN JOINT BOX). 1) Confirm that the ignition switch is turned OFF. 2) Remove the No. 6 fuse (in joint box) and perform visual inspection.	Is the fuse No. 6 blown out?	Replace the fuse No. 6. If fuse No. 6 is blown out again, repair the body harness. Or, replace the airbag main harness with body harness.	Go to step 3.
3 CHECK AIRBAG CONTROL MODULE. 1) Connect all connectors. 2) Erase the memory. 3) Perform the inspection mode. 4) Read out the DTC.	Is the same DTC displayed?	Replace the airbag control module. <Ref. to AB-18, Airbag Control Module.>	Go to step 4.
4 CHECK FOR ANY OTHER DTC ON DISPLAY.	Is any other DTC displayed?	Using the List of Diagnostic Trouble Code (DTC), check the DTC. <Ref. to AB(diag)-45, List of Diagnostic Trouble Code (DTC).>	Finish the diagnosis.

Diagnostic Chart with Trouble Code

AIRBAG SYSTEM (DIAGNOSTICS)

J: DTC 26 PASSENGER'S AIRBAG INDICATOR FAILURE

DTC DETECTING CONDITION:

- Passenger's airbag indicator is faulty.
- Airbag control module is faulty.
- Airbag main harness circuit is open.
- Open circuit of body harness.

CAUTION:

- Before diagnosing the airbag system, be sure to turn the ignition switch to OFF, disconnect the ground cable from battery, and wait more than 20 seconds before starting to work.
- Before replacing the airbag module, seat belt pretensioner, roll connector, control module, and sensor, reconnect each part and confirm that the warning light operates properly.
- When inspecting the airbag harness, disconnect each airbag module connector and seat belt pretensioner for safety reasons.

WIRING DIAGRAM:

- Auto A/C model

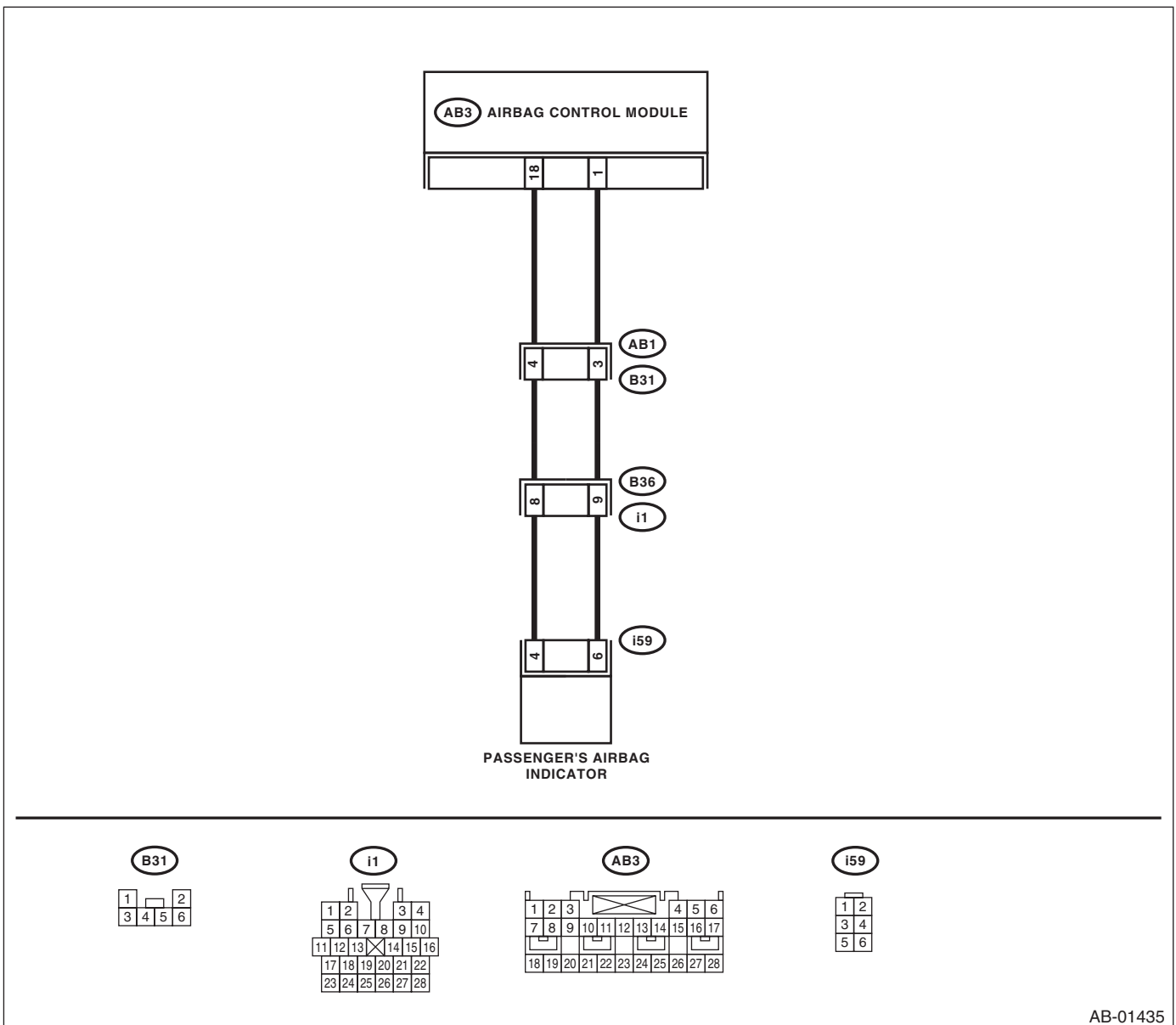

AB-01435

Diagnostic Chart with Trouble Code

AIRBAG SYSTEM (DIAGNOSTICS)

- Manual A/C model

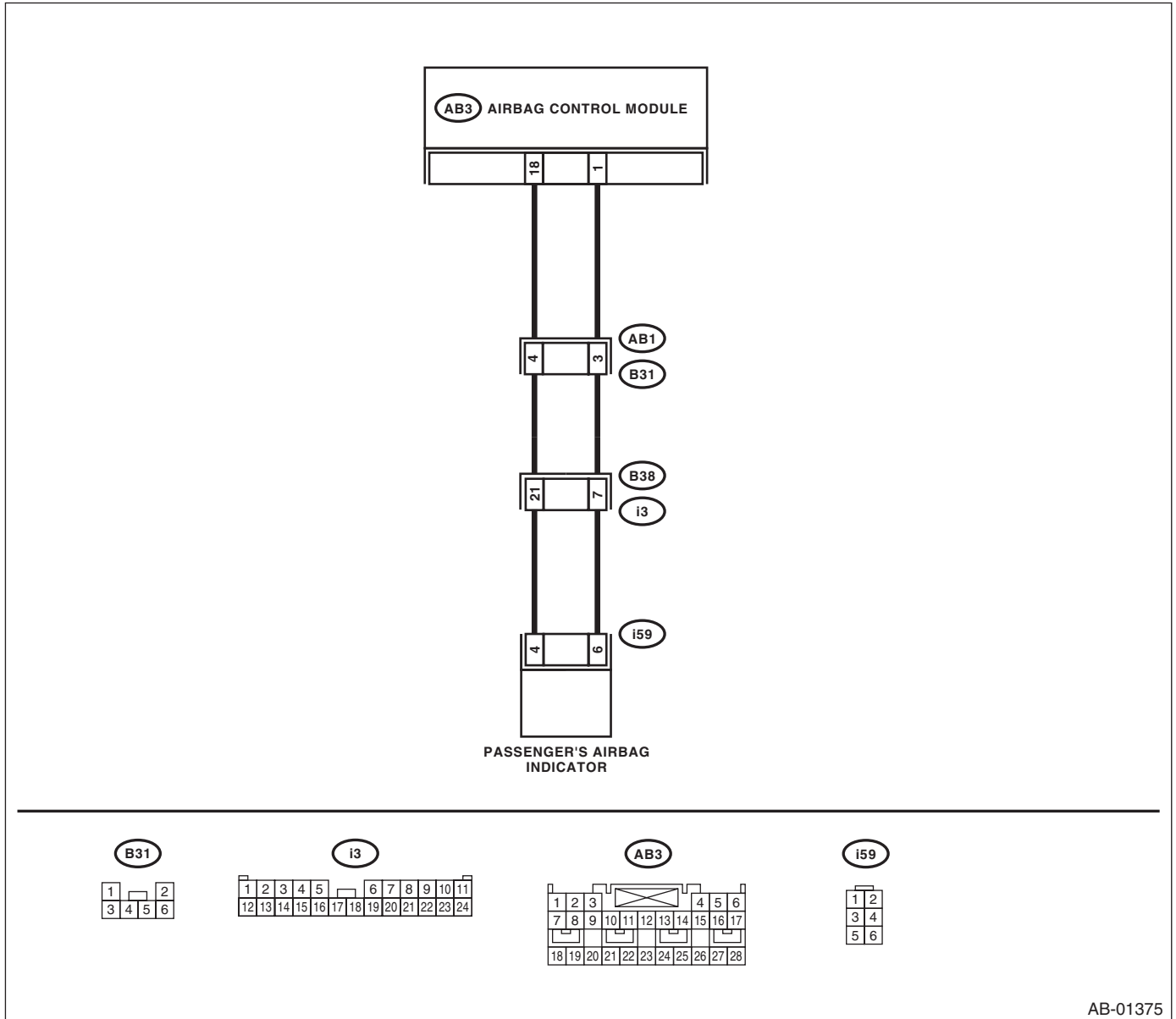

AB-01375

Diagnostic Chart with Trouble Code

AIRBAG SYSTEM (DIAGNOSTICS)

Step	Check	Yes	No
1 CHECK POOR CONTACT. 1) Turn the ignition switch to OFF, disconnect the battery ground cable, and wait more than 20 seconds. 2) Check the connector between the airbag control module and clock for firm contact.	Is there poor contact in each connector?	Replace the airbag harness connector.	Go to step 2.
2 CHECK AIRBAG MAIN HARNESS. 1) Disconnect the connector (AB3) from the airbag control module. 2) Connect the battery ground cable, and turn the ignition switch to ON. NOTE: If normal, neither of ON-OFF illuminates.	Does the passenger's airbag indicator illuminate?	Go to step 3.	Go to step 4.
3 CHECK AIRBAG MAIN HARNESS. 1) Turn the ignition switch to OFF. 2) Remove the clock, and disconnect the connector (i59). 3) Connect the connector (1U) in test harness U to connector (AB3). 4) Measure the resistance between connectors (2U) and (4U) in test harness U and chassis ground. Connector & terminal <i>(2U) No. 14 — (4U) No. 17:</i> <i>(2U) No. 14 — Chassis ground:</i> <i>(4U) No. 17 — Chassis ground:</i>	Is the resistance more than 1 M Ω ?	Replace the clock.	Repair the body harness. Or, replace the airbag main harness with body harness.
4 CHECK AIRBAG HARNESS. 1) Connect the connectors (7U) and (8U) in test harness U. 2) Connect the battery ground cable and turn the ignition switch to ON. NOTE: If normal, neither of ON-OFF illuminates.	Does the passenger's airbag indicator illuminate?	Replace the airbag control module. <Ref. to AB-18, Airbag Control Module.>	Go to step 5.
5 CHECK AIRBAG HARNESS. 1) Turn the ignition switch to OFF. 2) Connect the connector (1U) in test harness U to connector (AB3). 3) Measure the resistance between connectors (2U) and (4U) in test harness U and connector (i59). Connector & terminal <i>(2U) No. 14 — (i59) No. 6:</i> <i>(4U) No. 17 — (i59) No. 4:</i>	Is the resistance less than 10 Ω ?	Go to step 6.	Repair the body harness. Or, replace the airbag main harness with body harness.
6 CHECK AIRBAG HARNESS. 1) Turn the ignition switch to ON. 2) Measure the voltage between connector (i59) and chassis ground. Connector & terminal <i>(i59) No. 2 — Chassis ground:</i>	Is the voltage more than 10 V?	Replace the clock.	Repair the power supply line to clock.

Diagnostic Chart with Trouble Code

AIRBAG SYSTEM (DIAGNOSTICS)

K: DTC 27 ODS COMMUNICATION ERROR

DTC DETECTING CONDITION:

- Communication error with occupant detection control module.
- Airbag rear harness circuit is open, shorted or shorted to ground and power supply.
- Occupant detection harness (seat harness) is faulty.
- Occupant detection system is faulty.
- Airbag control module is faulty.

WIRING DIAGRAM:

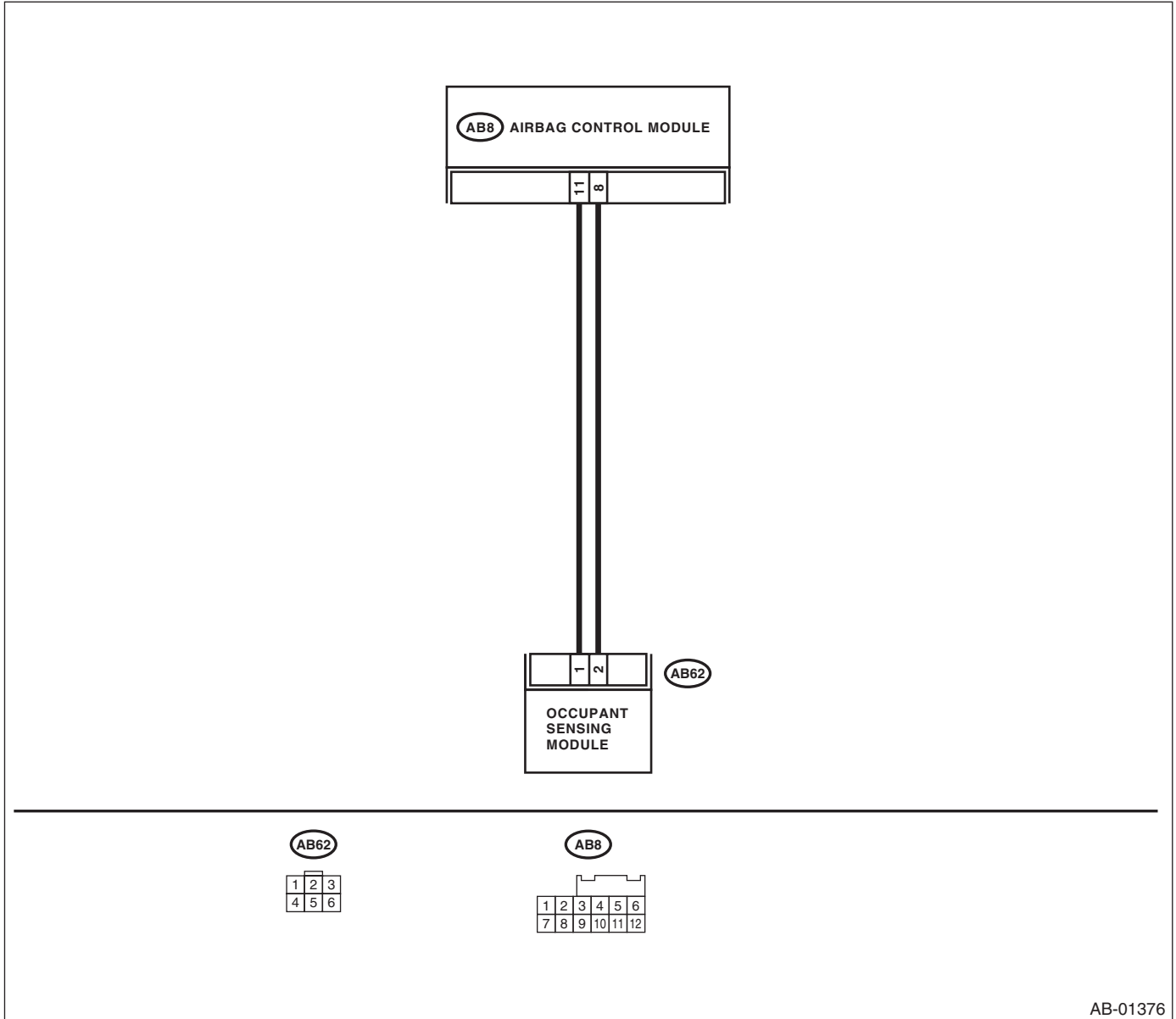

AB-01376

Diagnostic Chart with Trouble Code

AIRBAG SYSTEM (DIAGNOSTICS)

Step	Check	Yes	No
1 CHECK POOR CONTACT OF CONNECTORS. Check the connector between airbag control module and occupant detection control module for poor contact.	Is there poor contact?	Reconnect the connector. If the fault is not corrected, replace the side airbag harness RH or occupant detection harness (seat harness).	Go to step 2.
2 CHECK AIRBAG HARNESS. 1) Turn the ignition switch to OFF, disconnect the battery ground cable, and wait more than 20 seconds. 2) Disconnect the connector (AB8) from the airbag control module. 3) Disconnect the connector (AB 62) of underside of passenger's seat. 4) Connect the connector (1U) in test harness U to connector (AB8). 5) Connect the connector (1AB) in test harness AB to connector (AB62). 6) Measure the resistance between connector (3U) in test harness U and the connector (2AB) in test harness AB. Connector & terminal <i>(3U) No. 2 — (2AB) No. 1:</i> <i>(3U) No. 4 — (2AB) No. 2:</i>	Is the resistance less than 10 Ω ?	Go to step 3.	Replace the side airbag harness RH with body harness.
3 CHECK AIRBAG HARNESS. Measure the resistance between connector (3U) in test harness U and chassis ground. Connector & terminal <i>(3U) No. 2 — Chassis ground:</i> <i>(3U) No. 2 — (3U) No. 4:</i>	Is the resistance less than 10 Ω ?	Go to step 4.	Replace the side airbag harness RH with body harness.
4 CHECK AIRBAG HARNESS. 1) Turn the ignition switch to ON. 2) Measure the voltage between connector (2AB) in test harness AB and chassis ground. Connector & terminal <i>(2AB) No. 3 — Chassis ground:</i>	Is the voltage more than 9 V?	Go to step 5.	Check the battery voltage and fuse. Replace the side airbag harness RH with body harness if no faulty.
5 CHECK AIRBAG HARNESS. Measure the voltage between connector (2AB) in test harness AB and chassis ground. Connector & terminal <i>(2AB) No. 1 — Chassis ground:</i>	Is the voltage more than 9 V?	Replace the side airbag harness RH with body harness.	Replace the occupant detection harness (seat harness). If the fault is not corrected, replace the occupant detection system (seat cushion and frame assembly) and airbag control module in this order.

Diagnostic Chart with Trouble Code

AIRBAG SYSTEM (DIAGNOSTICS)

L: DTC 29 ODS FAILURE

NOTE:

For details concerning DTC 29, refer to “Occupant Detection System”. <Ref. to OD(diag)-30, DTC 29 ODS FAILURE, Diagnostic Procedure with Diagnostic Trouble Code (DTC).>

M: DTC 2A ODS CALIBRATION ERROR

NOTE:

For details concerning DTC 2A, refer to “Occupant Detection System”. <Ref. to OD(diag)-27, DTC 2A ODS CALIBRATION ERROR, Diagnostic Procedure with Diagnostic Trouble Code (DTC).>

N: DTC 2B ODS SYSTEM WRONG PARTS

NOTE:

For details concerning DTC 2B, refer to “Occupant Detection System”. <Ref. to OD(diag)-27, DTC 2B ODS SYSTEM WRONG PARTS, Diagnostic Procedure with Diagnostic Trouble Code (DTC).>

O: DTC 2C BELT TENSION SENSOR FAILURE

NOTE:

For details concerning DTC 2C, refer to “Occupant Detection System”. <Ref. to OD(diag)-28, DTC 2C BELT PRETENSIONER FAILURE, Diagnostic Procedure with Diagnostic Trouble Code (DTC).>

Diagnostic Chart with Trouble Code

AIRBAG SYSTEM (DIAGNOSTICS)

P: DTC 31 FRONT SUB SENSOR RH FAILURE

DTC DETECTING CONDITION:

- Airbag main harness is open, shorted or shorted to the power supply.
- Front sub sensor (RH) is faulty.
- Airbag control module is faulty.

CAUTION:

- Before diagnosing the airbag system, be sure to turn the ignition switch to OFF, disconnect the ground cable from battery, and wait more than 20 seconds before starting to work.
- Before replacing the airbag module, seat belt pretensioner, roll connector, control module, and sensor, reconnect each part and confirm that the warning light operates properly.
- When inspecting the airbag main harness, disconnect the driver's airbag module and passenger's airbag module connectors for safety reasons.

WIRING DIAGRAM:

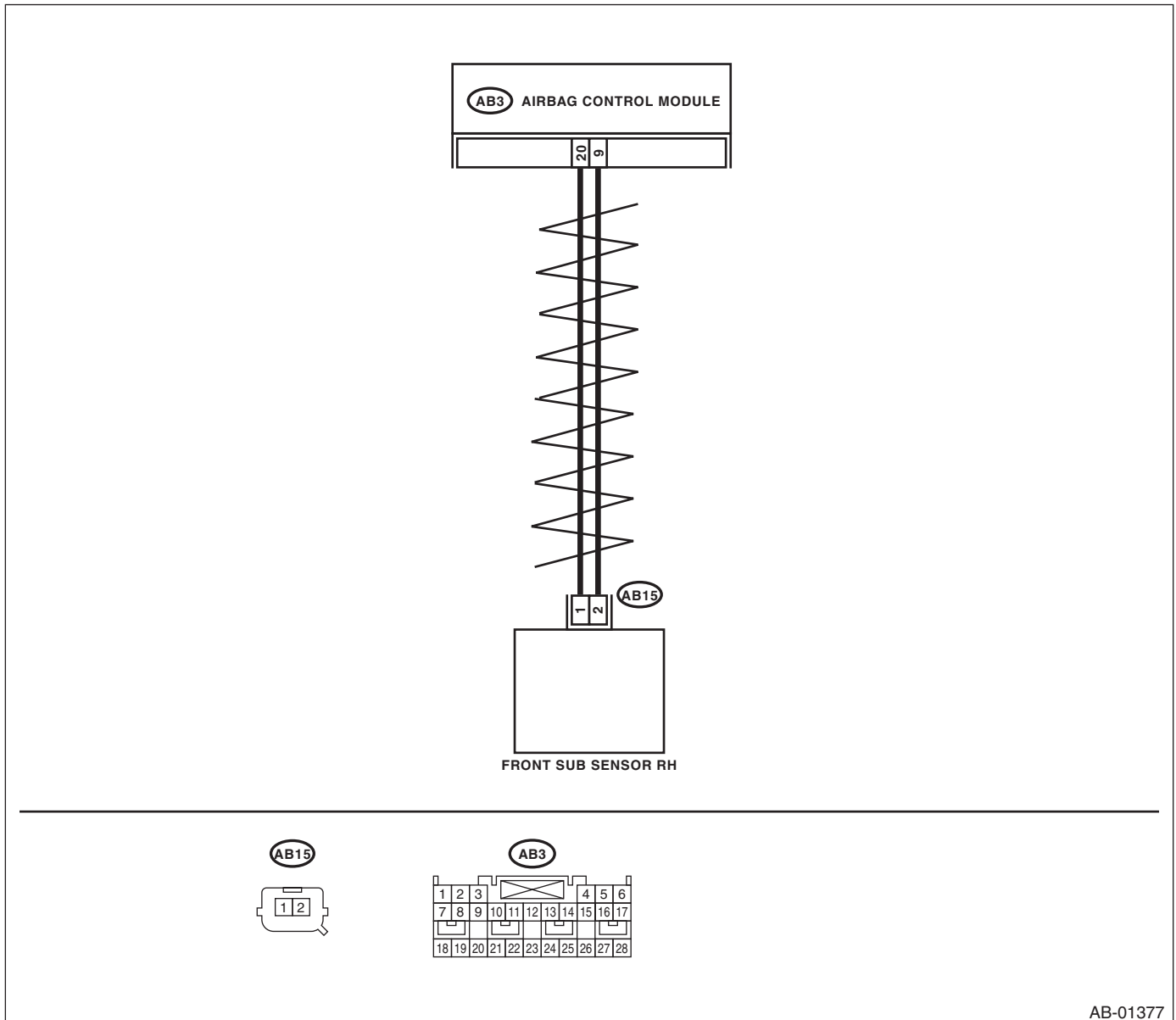

AB-01377

Diagnostic Chart with Trouble Code

AIRBAG SYSTEM (DIAGNOSTICS)

Step	Check	Yes	No
1 CHECK POOR CONTACT OF CONNECTORS. Check the connector between airbag control module and front sub sensor RH for poor contact.	Is there poor contact?	Replace the airbag main harness.	Go to step 2.
2 CHECK AIRBAG MAIN HARNESS (FRONT SUB SENSOR RH). 1) Turn the ignition switch to OFF, disconnect the battery ground cable, and wait more than 20 seconds. 2) Remove the instrument panel lower cover and disconnect the connectors (AB26) and (AB21). 3) Remove the instrument panel side cover on passenger side, and disconnect the connectors (AB27) and (AB4). 4) Disconnect the connector (AB3) from the airbag control module. 5) Connect the connector (1R) in test harness R to connector (AB3). 6) Disconnect the front sub sensor (RH), and connect the (1H) in test harness H to connector (AB15). 7) Measure the resistance between connector (3R) in test harness R and connector (3H) in test harness H. <i>Connector & terminal</i> <i>(3R) No. 7 — (3H) No. 5:</i> <i>(3R) No. 9 — (3H) No. 6:</i>	Is the resistance less than 10 Ω?	Go to step 3.	Replace the airbag main harness with body harness.
3 CHECK AIRBAG MAIN HARNESS (FRONT SUB SENSOR RH). Measure the resistance between connector (3R) in test harness R and the chassis ground. <i>Connector & terminal</i> <i>(3R) No. 7 — Chassis ground:</i> <i>(3R) No. 9 — Chassis ground:</i>	Is the resistance more than 1 MΩ?	Replace the front sub sensor (RH). <Ref. to AB-21, Front Sub Sensor.> When the problem is not corrected after sensor replacement, replace the airbag control module. <Ref. to AB-18, Airbag Control Module.>	Go to step 4.
4 CHECK AIRBAG CONTROL MODULE. 1) Connect all connectors. 2) Erase the memory. 3) Perform the inspection mode. 4) Read out the DTC.	Is the same DTC displayed?	Replace the airbag control module. <Ref. to AB-18, Airbag Control Module.>	Go to step 5.
5 CHECK FOR ANY OTHER DTC ON DISPLAY.	Is any other DTC displayed?	Using the List of Diagnostic Trouble Code (DTC), check the DTC. <Ref. to AB(diag)-45, List of Diagnostic Trouble Code (DTC).>	Finish the diagnosis.

Diagnostic Chart with Trouble Code

AIRBAG SYSTEM (DIAGNOSTICS)

Q: DTC 32 FRONT SUB SENSOR LH FAILURE

DTC DETECTING CONDITION:

- Airbag main harness is open, shorted or shorted to the power supply.
- Front sub-sensor (LH) is faulty.
- Airbag control module is faulty.

CAUTION:

- Before diagnosing the airbag system, be sure to turn the ignition switch to OFF, disconnect the ground cable from battery, and wait more than 20 seconds before starting to work.
- Before replacing the airbag module, seat belt pretensioner, roll connector, control module, and sensor, reconnect each part and confirm that the warning light operates properly.
- When inspecting the airbag main harness, disconnect the airbag module connector of the driver and passenger seats for safety reasons.

WIRING DIAGRAM:

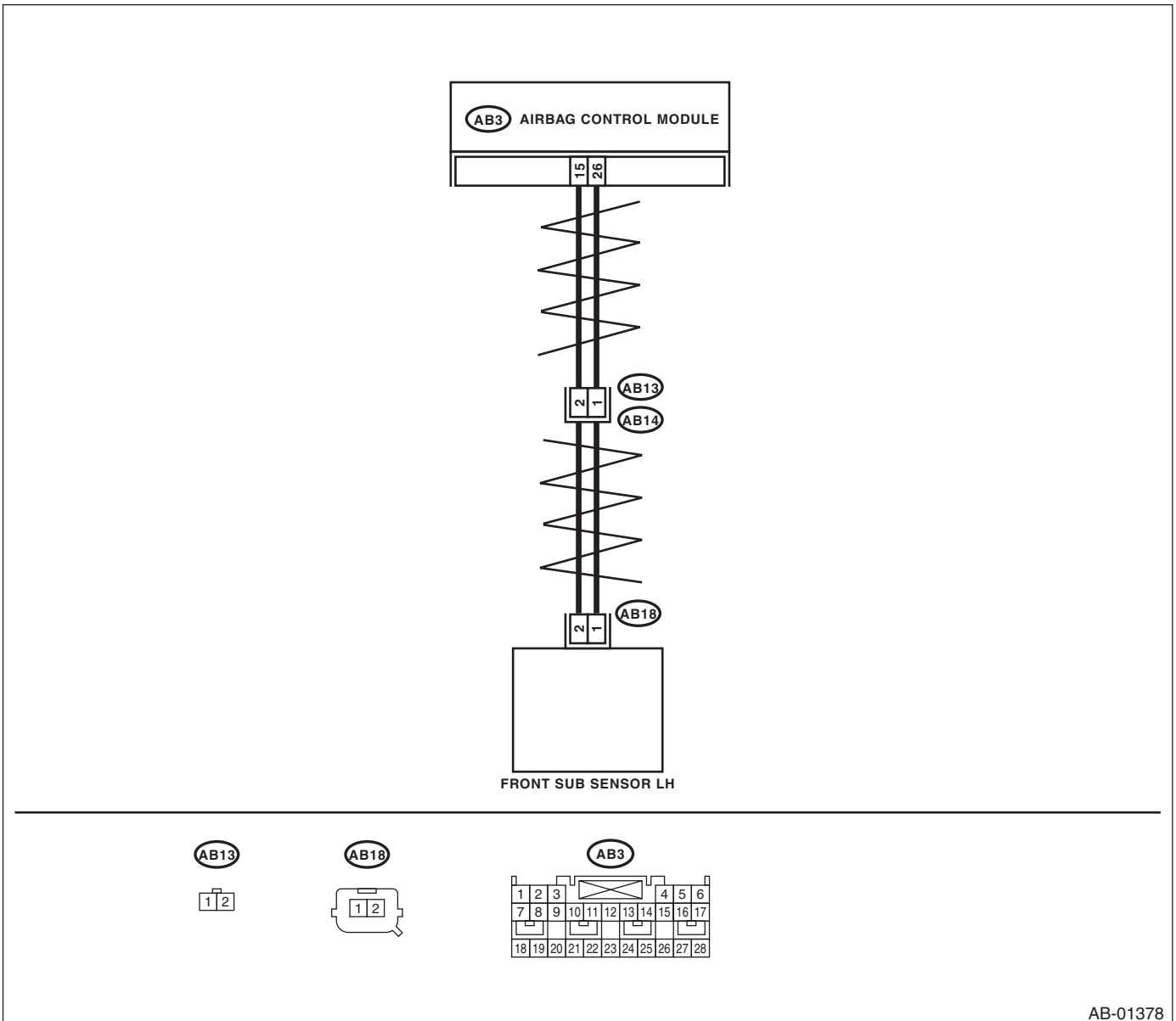

AB-01378

Diagnostic Chart with Trouble Code

AIRBAG SYSTEM (DIAGNOSTICS)

Step	Check	Yes	No
1 CHECK POOR CONTACT OF CONNECTORS. Check the connector between airbag control module and front sub sensor LH for poor contact.	Is there poor contact?	Replace the airbag main harness with body harness.	Go to step 2.
2 CHECK AIRBAG MAIN HARNESS (FRONT SUB SENSOR LH). 1) Turn the ignition switch to OFF, disconnect the battery ground cable, and wait more than 20 seconds. 2) Remove the instrument panel lower cover and disconnect the connectors (AB26) and (AB21). 3) Remove the console side cover lower on passenger side, and disconnect the connectors (AB27) and (AB4). 4) Disconnect the connector (AB3) from the airbag control module. 5) Connect the connector (1R) in test harness R to connector (AB3). 6) Disconnect the front sub sensor (LH), and connect the (1H) in test harness H to connector (AB18). 7) Measure the resistance between connector (3R) in test harness R and connector (3H) in test harness H. <i>Connector & terminal</i> <i>(3R) No. 6 — (3H) No. 5:</i> <i>(3R) No. 8 — (3H) No. 6:</i>	Is the resistance less than 10 Ω?	Go to step 3.	Replace the airbag main harness with body harness.
3 CHECK AIRBAG MAIN HARNESS (FRONT SUB SENSOR LH). Measure the resistance between connector (3R) in test harness R and the chassis ground. <i>Connector & terminal</i> <i>(3R) No. 6 — Chassis ground:</i> <i>(3R) No. 8 — Chassis ground:</i>	Is the resistance more than 1 MΩ?	Replace the front sub sensor (LH). <Ref. to AB-21, Front Sub Sensor.> When the problem is not corrected after sensor replacement, replace the airbag control module. <Ref. to AB-18, Airbag Control Module.>	Go to step 4.
4 CHECK AIRBAG CONTROL MODULE. 1) Connect all connectors. 2) Erase the memory. 3) Perform the inspection mode. 4) Read out the DTC.	Is the same DTC displayed?	Replace the airbag control module. <Ref. to AB-18, Airbag Control Module.>	Go to step 5.
5 CHECK FOR ANY OTHER DTC ON DISPLAY.	Is any other DTC displayed?	Using the List of Diagnostic Trouble Code (DTC), check the DTC. <Ref. to AB(diag)-45, List of Diagnostic Trouble Code (DTC).>	Finish the diagnosis.

Diagnostic Chart with Trouble Code

AIRBAG SYSTEM (DIAGNOSTICS)

R: DTC 33 FRONT SUB SENSOR RH FAILURE

DTC DETECTING CONDITION:

Front sub sensor (RH) is faulty.

When Code 33 is displayed, the circuit within the front sub sensor (RH) is faulty. Replace the front sub sensor (RH). <Ref. to AB-21, Front Sub Sensor.>

S: DTC 34 FRONT SUB SENSOR LH FAILURE

DTC DETECTING CONDITION:

Front sub-sensor (LH) is faulty.

When Code 34 is displayed, the circuit within the front sub sensor (LH) is faulty. Replace the front sub sensor (LH). <Ref. to AB-21, Front Sub Sensor.>

Diagnostic Chart with Trouble Code

AIRBAG SYSTEM (DIAGNOSTICS)

T: DTC 36 SEAT POSITION SENSOR LH FAILURE

DTC DETECTING CONDITION:

- Driver's seat position sensor is faulty.
- Airbag control module is faulty.
- Side airbag harness circuit is open, shorted or shorted to ground.

CAUTION:

- Before diagnosing the airbag system, be sure to turn the ignition switch to OFF, disconnect the ground cable from battery, and wait more than 20 seconds before starting to work.
- Before replacing the airbag module, seat belt pretensioner, roll connector, control module, and sensor, reconnect each part and confirm that the warning light operates properly.
- When inspecting the airbag harness, disconnect each airbag module connector and seat belt pretensioner for safety reasons.

WIRING DIAGRAM:

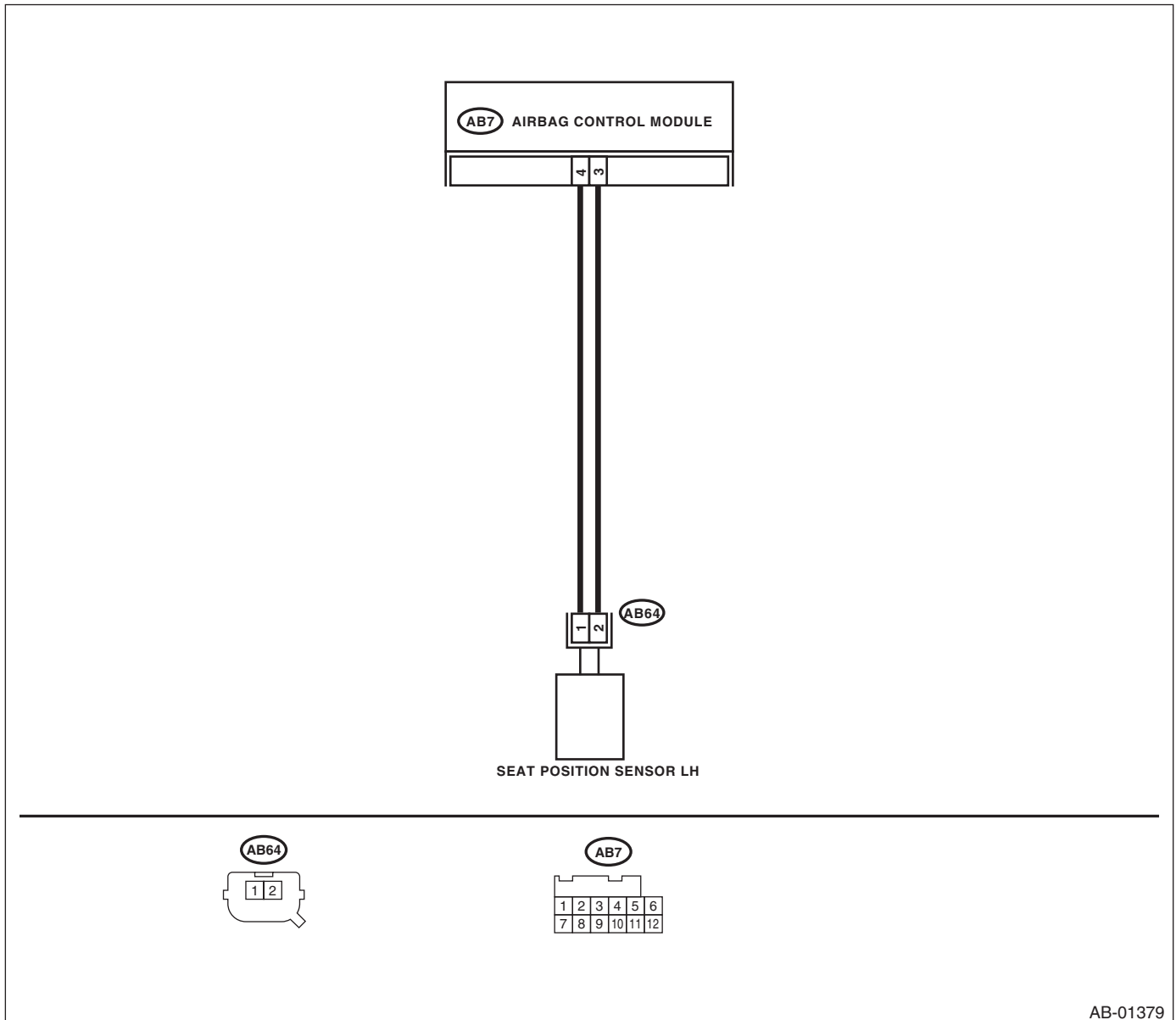

AB-01379

Diagnostic Chart with Trouble Code

AIRBAG SYSTEM (DIAGNOSTICS)

Step	Check	Yes	No
1 CHECK SEAT POSITION SENSOR (LH). 1) Turn the ignition switch to OFF, disconnect the battery ground cable, and wait more than 20 seconds. 2) Disconnect the connector (AB64) from seat position sensor (LH). 3) Connect the connector (2Y) in test harness Y to connector (AB64). 4) Connect the battery ground cable, and turn the ignition switch to ON.	Does the airbag warning light illuminate for 6 seconds then go off?	Replace the seat position sensor (LH) with slide rail assembly in driver's side. <Ref. to SE-7, Front Seat.>	Go to step 2.
2 CHECK SIDE AIRBAG HARNESS (SEAT POSITION SENSOR HARNESS LH). 1) Turn the ignition switch to OFF, disconnect the battery ground cable, and wait more than 20 seconds. 2) Disconnect the connector (AB7) from the airbag control module. 3) Connect the connector (1R) in test harness R to connector (AB26). 4) Disconnect the seat position sensor (LH), and connect the (1H) in test harness H to connector (AB64). 5) Measure the resistance between connector (3R) in test harness R and connector (3H) in test harness H. <i>Connector & terminal</i> <i>(3R) No. 1 — (3H) No. 6:</i> <i>(3R) No. 3 — (3H) No. 5:</i>	Is the resistance less than 10 Ω ?	Go to step 3.	Replace the side airbag harness with body harness.
3 CHECK SIDE AIRBAG HARNESS. Measure the resistance between connector (3R) in test harness R and the chassis ground. <i>Connector & terminal</i> <i>(3R) No. 1 — Chassis ground:</i>	Is the resistance less than 10 Ω ?	Replace the side airbag harness with body harness.	Replace the airbag control module.

U: DTC 37 BUCKLE SWITCH RH FAILURE

NOTE:

For details concerning DTC 37, refer to "Occupant Detection System". <Ref. to OD(diag)-31, DTC 37 BUCKLE SWITCH RH FAILURE, Diagnostic Procedure with Diagnostic Trouble Code (DTC).>

Diagnostic Chart with Trouble Code

AIRBAG SYSTEM (DIAGNOSTICS)

V: DTC 38 BUCKLE SWITCH LH FAILURE

DTC DETECTING CONDITION:

- Driver's buckle switch circuit is open, shorted or shorted to ground.
- Side airbag harness circuit is open, shorted or shorted to ground.
- Airbag control module is faulty.

CAUTION:

- Before diagnosing the airbag system, be sure to turn the ignition switch to OFF, disconnect the ground cable from battery, and wait more than 20 seconds before starting to work.
- Before replacing the airbag module, seat belt pretensioner, roll connector, control module, and sensor, reconnect each part and confirm that the warning light operates properly.
- When inspecting the airbag harness, disconnect each airbag module connector and seat belt pretensioner for safety reasons.

WIRING DIAGRAM:

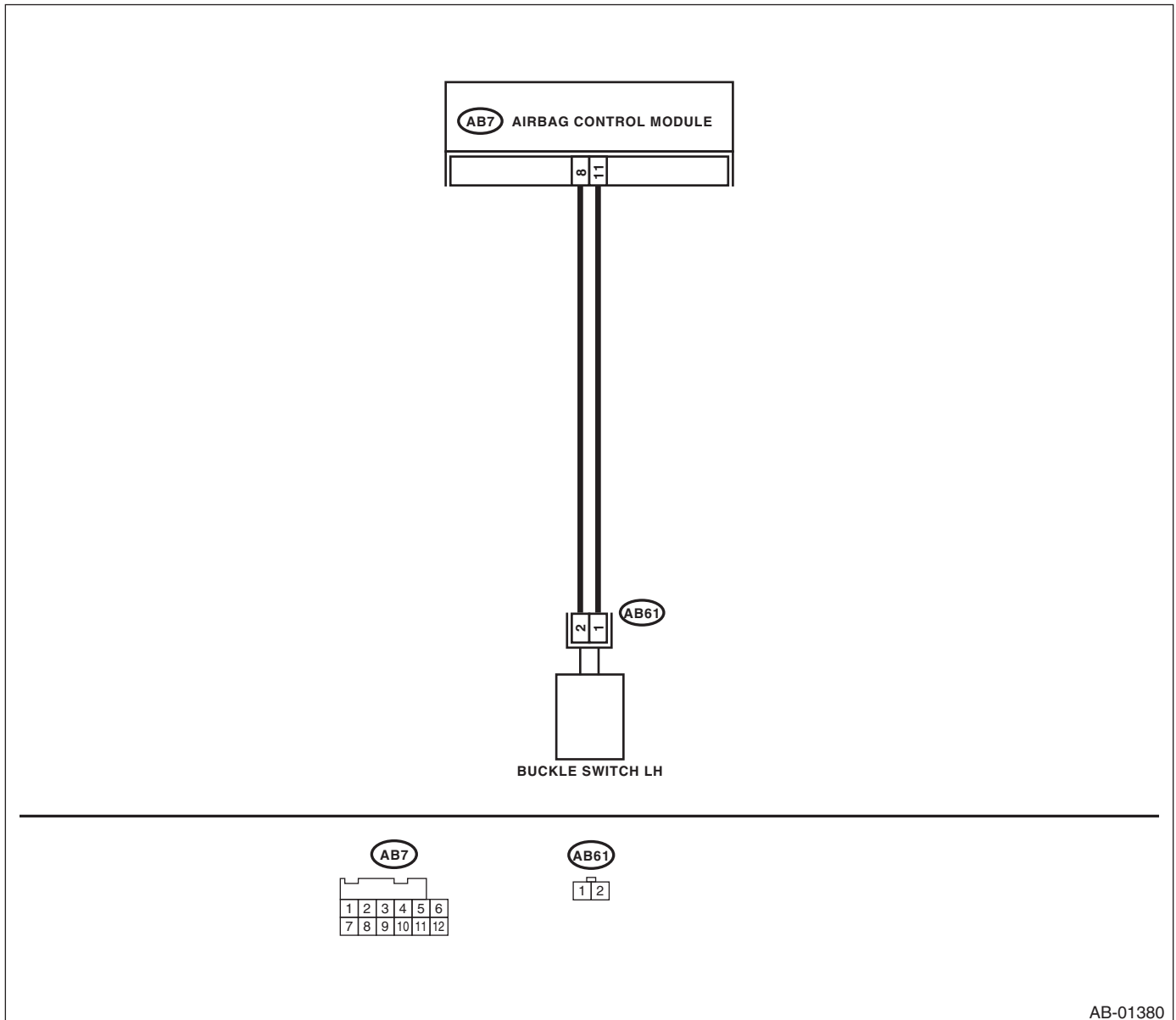

AB-01380

Diagnostic Chart with Trouble Code

AIRBAG SYSTEM (DIAGNOSTICS)

Step	Check	Yes	No
1 CHECK SEAT BELT BUCKLE SWITCH (LH). 1) Turn the ignition switch to OFF, disconnect the battery ground cable, and wait more than 20 seconds. 2) Disconnect the connector (AB61) from buckle switch (LH). 3) Connect the connector (1Y) in test harness Y to connector (AB61). 4) Connect the battery ground cable, and turn the ignition switch to ON.	Does the airbag warning light illuminate for 6 seconds then go off?	Replace the seat belt buckle switch (LH). <Ref. to SB-10, Front Seat Belt.>	Go to step 2.
2 CHECK SIDE AIRBAG HARNESS (BUCKLE SWITCH HARNESS LH). 1) Turn the ignition switch to OFF, disconnect the battery ground cable, and wait more than 20 seconds. 2) Disconnect the connector (AB7) from the airbag control module. 3) Connect the connector (1R) in test harness R to the connector (AB7). 4) Disconnect the seat belt buckle switch (LH), and connect the (1D) in test harness D to connector (AB61). 5) Measure the resistance between connector (4R) in test harness R and the connector (3D) in test harness D. <i>Connector & terminal</i> <i>(4R) No. 11 — (3D) No. 3:</i> <i>(4R) No. 9 — (3D) No. 4:</i>	Is the resistance less than 10 Ω ?	Go to step 3.	Replace the side airbag harness with body harness.
3 CHECK AIRBAG REAR HARNESS. Measure the resistance between connector (4R) in test harness R and the chassis ground. <i>Connector & terminal</i> <i>(4R) No. 9 — Chassis ground:</i> <i>(4R) No. 9 — (4R) No. 11:</i>	Is the resistance less than 10 Ω ?	Replace the side airbag harness with body harness.	Replace the airbag control module.

Diagnostic Chart with Trouble Code

AIRBAG SYSTEM (DIAGNOSTICS)

W: DTC 41 SIDE AIRBAG RH FAILURE

DTC DETECTING CONDITION:

- Side airbag harness (RH) is faulty.
- Side airbag module (RH) is faulty.
- Airbag control module is faulty.

CAUTION:

- Before diagnosing the airbag system, be sure to turn the ignition switch to OFF, disconnect the ground cable from battery, and wait more than 20 seconds before starting to work.
- Before replacing the airbag module, seat belt pretensioner, roll connector, control module, and sensor, reconnect each part and confirm that the warning light operates properly.
- When inspecting the airbag main harness, disconnect the driver's airbag module and passenger's airbag module connectors for safety reasons.
- When inspecting the side airbag harness, disconnect the side airbag module connector and seat belt pretensioner connector for the safety reasons.

WIRING DIAGRAM:

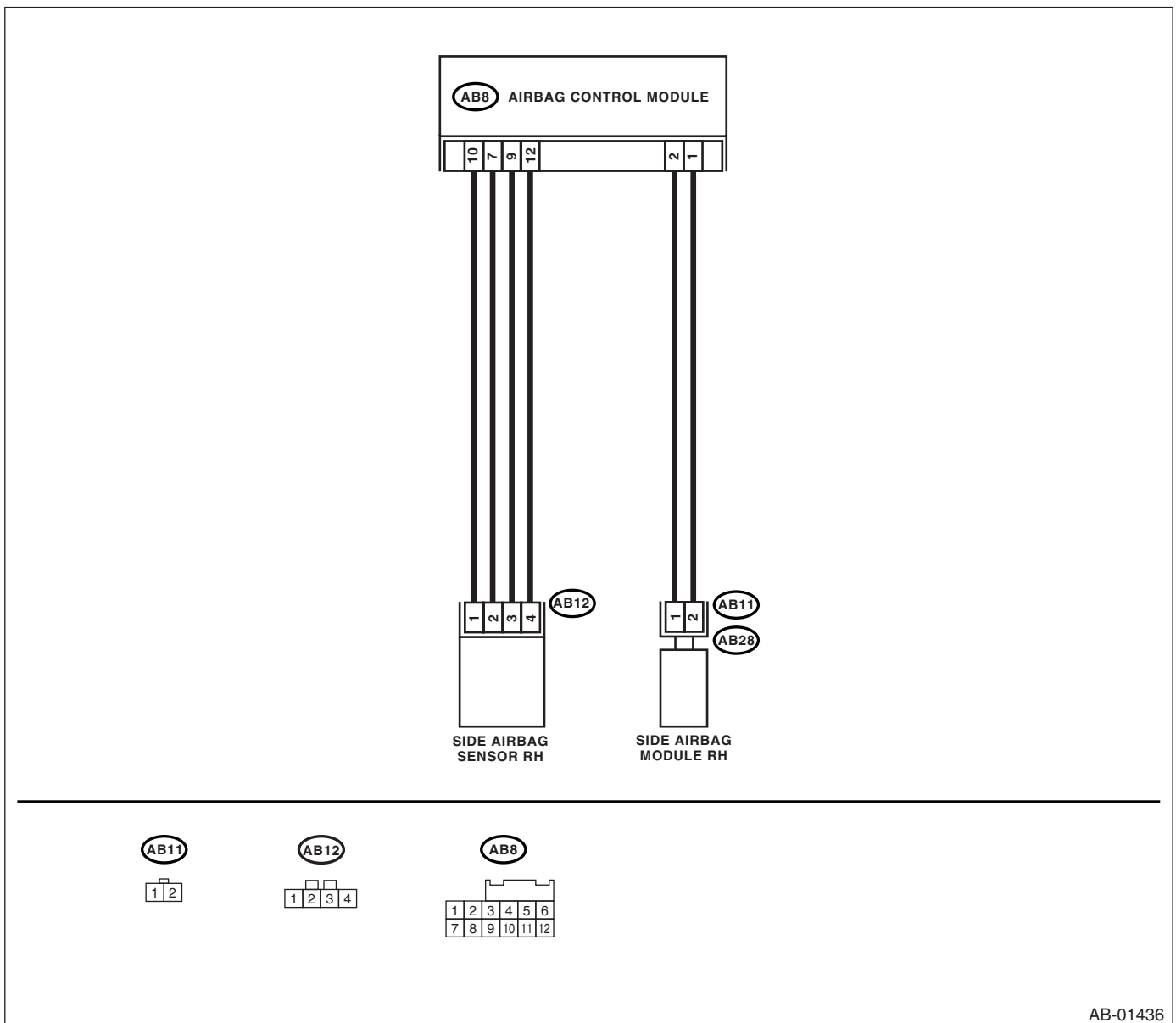

AB-01436

Diagnostic Chart with Trouble Code

AIRBAG SYSTEM (DIAGNOSTICS)

Step	Check	Yes	No
1 CHECK POOR CONTACT OF CONNECTORS. Check the connector between airbag control module, and side airbag module RH and side airbag sensor RH for poor contact.	Is there poor contact?	Replace the side airbag harness with body harness.	Go to step 2.
2 CHECK SIDE AIRBAG MODULE. 1) Turn the ignition switch to OFF, disconnect the battery ground cable, and wait more than 20 seconds. 2) Disconnect the connector (AB11) from side airbag module (RH), and connect the connector (1F) in test harness F to connector (AB11). 3) Connect the airbag resistor to connector (3F) in test harness F. 4) Connect the battery ground cable, and turn the ignition switch to ON.	Does the airbag warning light illuminate for 6 seconds then go off?	Replace the front seat with side airbag module (RH). <Ref. to SE-7, Front Seat.>	Go to step 3.
3 CHECK SIDE AIRBAG HARNESS (RH). 1) Turn the ignition switch to OFF, disconnect the battery ground cable, and wait more than 20 seconds. 2) Disconnect the connector (AB20) from seat belt pretensioner (RH). 3) Disconnect the airbag resistor from test harness F. 4) Disconnect the connector (AB8) from the airbag control module. 5) Connect the connector (1R) in test harness R to connector (AB8). 6) Measure the resistance between connector (3R) in test harness R and connector (3F) in test harness F. Connector & terminal (3R) No. 18 — (3F) No. 4: (3R) No. 20 — (3F) No. 3:	Is the resistance less than 10 Ω ?	Go to step 4.	Replace the side airbag harness with body harness.
4 CHECK SIDE AIRBAG HARNESS (RH). Measure the resistance between the connector (3R) terminals in test harness R. Connector & terminal (3R) No. 18 — (3R) No. 20:	Is the resistance more than 1 M Ω ?	Go to step 5.	Replace the side airbag harness with body harness.
5 CHECK SIDE AIRBAG HARNESS (RH). Measure the resistance between connector (3R) in test harness R and the chassis ground. Connector & terminal (3R) No. 18 — Chassis ground: (3R) No. 20 — Chassis ground:	Is the resistance more than 1 M Ω ?	Go to step 6.	Replace the side airbag harness with body harness.
6 CHECK AIRBAG CONTROL MODULE. 1) Connect all connectors. 2) Erase the memory. 3) Perform the inspection mode. 4) Read out the DTC.	Is the same DTC displayed?	Replace the airbag control module. <Ref. to AB-18, Airbag Control Module.>	Go to step 7.
7 CHECK FOR ANY OTHER DTC ON DISPLAY.	Is any other DTC displayed?	Using the List of Diagnostic Trouble Code (DTC), check the DTC. <Ref. to AB(diag)-45, List of Diagnostic Trouble Code (DTC).>	Finish the diagnosis.

Diagnostic Chart with Trouble Code

AIRBAG SYSTEM (DIAGNOSTICS)

X: DTC 42 SIDE AIRBAG LH FAILURE

DTC DETECTING CONDITION:

- Side airbag harness (LH) is faulty.
- Side airbag module (LH) is faulty.
- Airbag control module is faulty.

CAUTION:

- Before diagnosing the airbag system, be sure to turn the ignition switch to OFF, disconnect the ground cable from battery, and wait more than 20 seconds before starting to work.
- Before replacing the airbag module, seat belt pretensioner, roll connector, control module, and sensor, reconnect each part and confirm that the warning light operates properly.
- When inspecting the airbag main harness, disconnect the driver's airbag module and passenger's airbag module connectors for safety reasons.
- When inspecting the side airbag harness, disconnect the side airbag module connector and seat belt pretensioner connector for the safety reasons.

WIRING DIAGRAM:

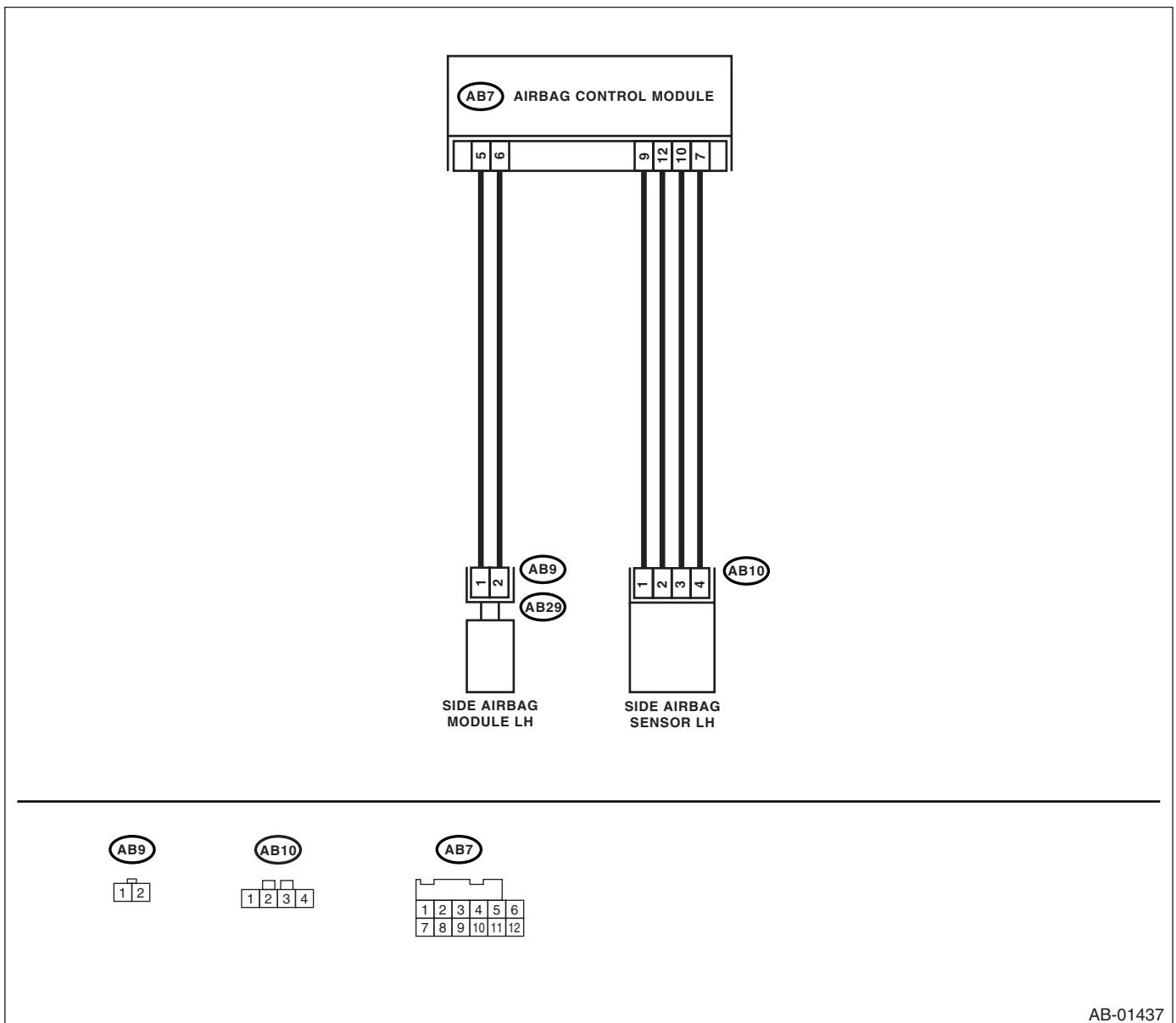

AB-01437

Diagnostic Chart with Trouble Code

AIRBAG SYSTEM (DIAGNOSTICS)

Step	Check	Yes	No
1 CHECK POOR CONTACT OF CONNECTORS. Check the connector between airbag control module, and side airbag module LH and side airbag sensor LH for poor contact.	Is there poor contact?	Replace the side airbag harness with body harness.	Go to step 2.
2 CHECK SIDE AIRBAG MODULE. 1) Turn the ignition switch to OFF, disconnect the battery ground cable, and wait more than 20 seconds. 2) Disconnect the connector (AB9) from side airbag module (LH), and connect the connector (1F) in test harness F to connector (AB9). 3) Connect the airbag resistor to connector (3F) in test harness F. 4) Connect the battery ground cable, and turn the ignition switch to ON.	Does the airbag warning light illuminate for 6 seconds then go off?	Replace the front seat with side airbag module (LH). <Ref. to SE-7, Front Seat.>	Go to step 3.
3 CHECK SIDE AIRBAG HARNESS (LH). 1) Turn the ignition switch to OFF, disconnect the battery ground cable, and wait more than 20 seconds. 2) Disconnect the connector (AB19) from seat belt pretensioner (LH). 3) Disconnect the airbag resistor from the test harness. 4) Disconnect the connector (AB7) from the airbag control module. 5) Connect the connector (1R) in test harness R to the connector (AB7). 6) Measure the resistance between connector (3R) in test harness R and connector (3F) in test harness F. Connector & terminal (3R) No. 12 — (3F) No. 3: (3R) No. 10 — (3F) No. 4:	Is the resistance less than 10 Ω?	Go to step 4.	Replace the side airbag harness with body harness.
4 CHECK SIDE AIRBAG HARNESS (LH). Measure the resistance between the connector (3R) terminals in test harness R. Connector & terminal (3R) No. 12 — (3R) No. 10:	Is the resistance more than 1 MΩ?	Go to step 5.	Replace the side airbag harness with body harness.
5 CHECK SIDE AIRBAG HARNESS (LH). Measure the resistance between connector (3R) in test harness R and the chassis ground. Connector & terminal (3R) No. 10 — Chassis ground: (3R) No. 12 — Chassis ground:	Is the resistance more than 1 MΩ?	Go to step 6.	Replace the side airbag harness with body harness.
6 CHECK AIRBAG CONTROL MODULE. 1) Connect all connectors. 2) Erase the memory. 3) Perform the inspection mode. 4) Read out the DTC.	Is the same DTC displayed?	Replace the airbag control module. <Ref. to AB-18, Airbag Control Module.>	Go to step 7.
7 CHECK FOR ANY OTHER DTC ON DISPLAY.	Is any other DTC displayed?	Using the List of Diagnostic Trouble Code (DTC), check the DTC. <Ref. to AB(diag)-45, List of Diagnostic Trouble Code (DTC).>	Finish the diagnosis.

Diagnostic Chart with Trouble Code

AIRBAG SYSTEM (DIAGNOSTICS)

Y: DTC 45 SIDE AIRBAG RH FAILURE

DTC DETECTING CONDITION:

- Side airbag harness is shorted to power supply.
- Side airbag module (RH) is faulty.
- Airbag control module is faulty.

CAUTION:

- Before diagnosing the airbag system, be sure to turn the ignition switch to OFF, disconnect the ground cable from battery, and wait more than 20 seconds before starting to work.
- Before replacing the airbag module, seat belt pretensioner, roll connector, control module, and sensor, reconnect each part and confirm that the warning light operates properly.
- When inspecting the airbag main harness, disconnect the driver's airbag module and passenger's airbag module connectors for safety reasons.
- When inspecting the side airbag harness, disconnect the side airbag module connector and seat belt pretensioner connector for the safety reasons.

WIRING DIAGRAM:

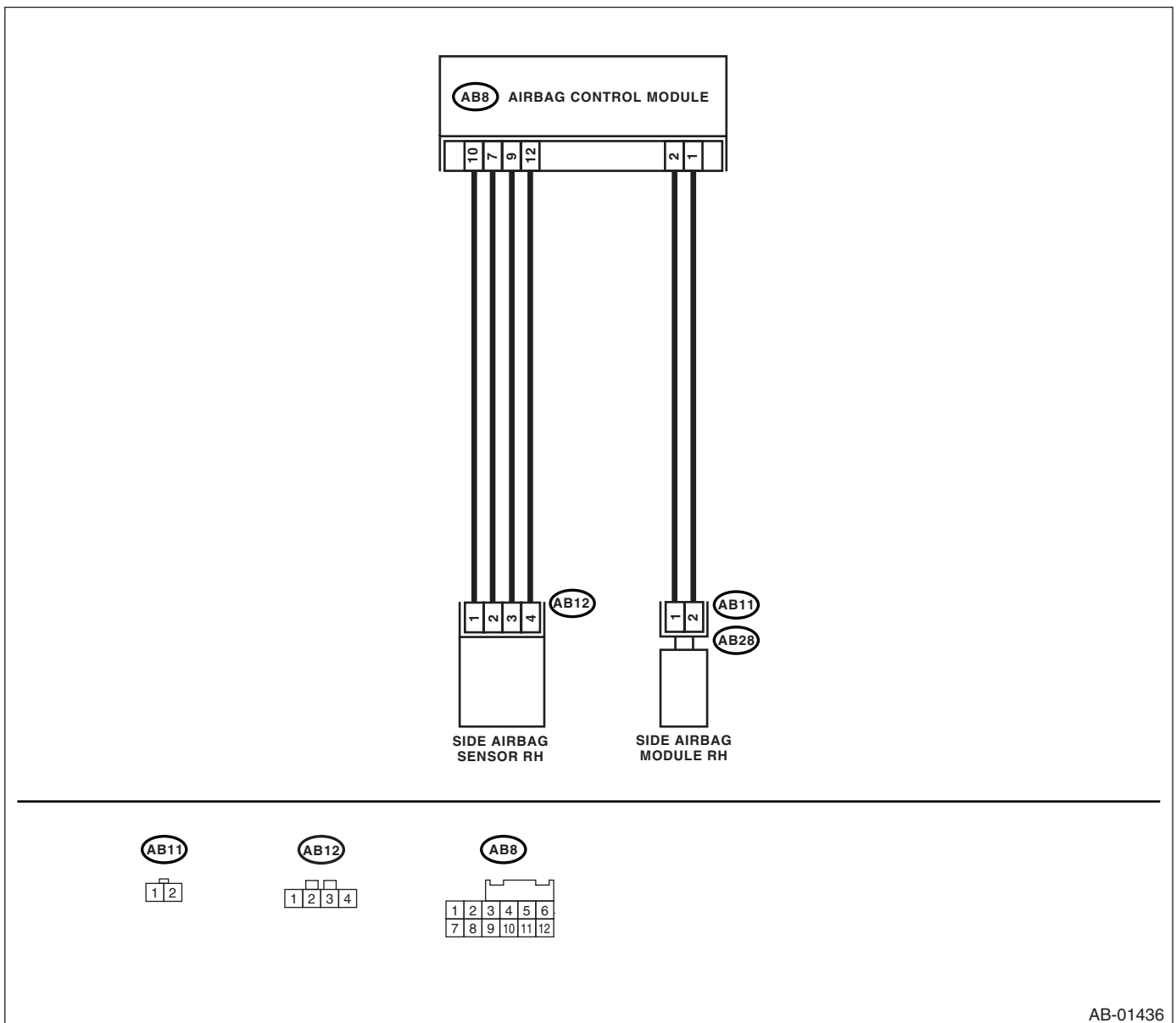

AB-01436

Diagnostic Chart with Trouble Code

AIRBAG SYSTEM (DIAGNOSTICS)

Step	Check	Yes	No
1 CHECK POOR CONTACT OF CONNECTORS. Check the connector between airbag control module, and side airbag module RH and side airbag sensor RH for poor contact.	Is there poor contact?	Replace the side airbag harness with body harness.	Go to step 2.
2 CHECK SIDE AIRBAG MODULE. 1) Turn the ignition switch to OFF, disconnect the battery ground cable, and wait more than 20 seconds. 2) Disconnect the connector (AB11) from side airbag module (RH), and connect the connector (1F) in test harness F to connector (AB11). 3) Connect the airbag resistor to connector (3F) in test harness F. 4) Connect the battery ground cable, and turn the ignition switch to ON.	Does the airbag warning light illuminate for 6 seconds then go off?	Replace the front seat with side airbag module (RH). <Ref. to SE-7, Front Seat.>	Go to step 3.
3 CHECK SIDE AIRBAG HARNESS (RH). 1) Turn the ignition switch to OFF, disconnect the battery ground cable, and wait more than 20 seconds. 2) Disconnect the connector (AB20) from seat belt pretensioner (RH). 3) Disconnect the airbag resistor from the test harness. 4) Disconnect the connector (AB8) from the airbag control module. 5) Connect the connector (1R) in test harness R to the connector (AB8). 6) Connect the battery ground cable, and turn the ignition switch to ON. 7) Measure the voltage between connector (3R) in test harness R and the chassis ground. Connector & terminal <i>(3R) No. 18 (+) — Chassis ground (-):</i> <i>(3R) No. 20 (+) — Chassis ground (-):</i>	Is the voltage less than 1 V?	Go to step 4.	Replace the side airbag harness with body harness.
4 CHECK AIRBAG CONTROL MODULE. 1) Connect all connectors. 2) Erase the memory. 3) Perform the inspection mode. 4) Read out the DTC.	Is the same DTC displayed?	Replace the airbag control module. <Ref. to AB-18, Airbag Control Module.>	Go to step 5.
5 CHECK FOR ANY OTHER DTC ON DISPLAY.	Is any other DTC displayed?	Using the List of Diagnostic Trouble Code (DTC), check the DTC. <Ref. to AB(diag)-45, List of Diagnostic Trouble Code (DTC).>	Finish the diagnosis.

Diagnostic Chart with Trouble Code

AIRBAG SYSTEM (DIAGNOSTICS)

Z: DTC 46 SIDE AIRBAG LH FAILURE

DTC DETECTING CONDITION:

- Side airbag harness is shorted to power supply.
- Side airbag module (LH) is faulty.
- Airbag control module is faulty.

CAUTION:

- Before diagnosing the airbag system, be sure to turn the ignition switch to OFF, disconnect the ground cable from battery, and wait more than 20 seconds before starting to work.
- Before replacing the airbag module, seat belt pretensioner, roll connector, control module, and sensor, reconnect each part and confirm that the warning light operates properly.
- When inspecting the airbag main harness, disconnect the driver's airbag module and passenger's airbag module connectors for safety reasons.
- When inspecting the side airbag harness, disconnect the side airbag module connector and seat belt pretensioner connector for the safety reasons.

WIRING DIAGRAM:

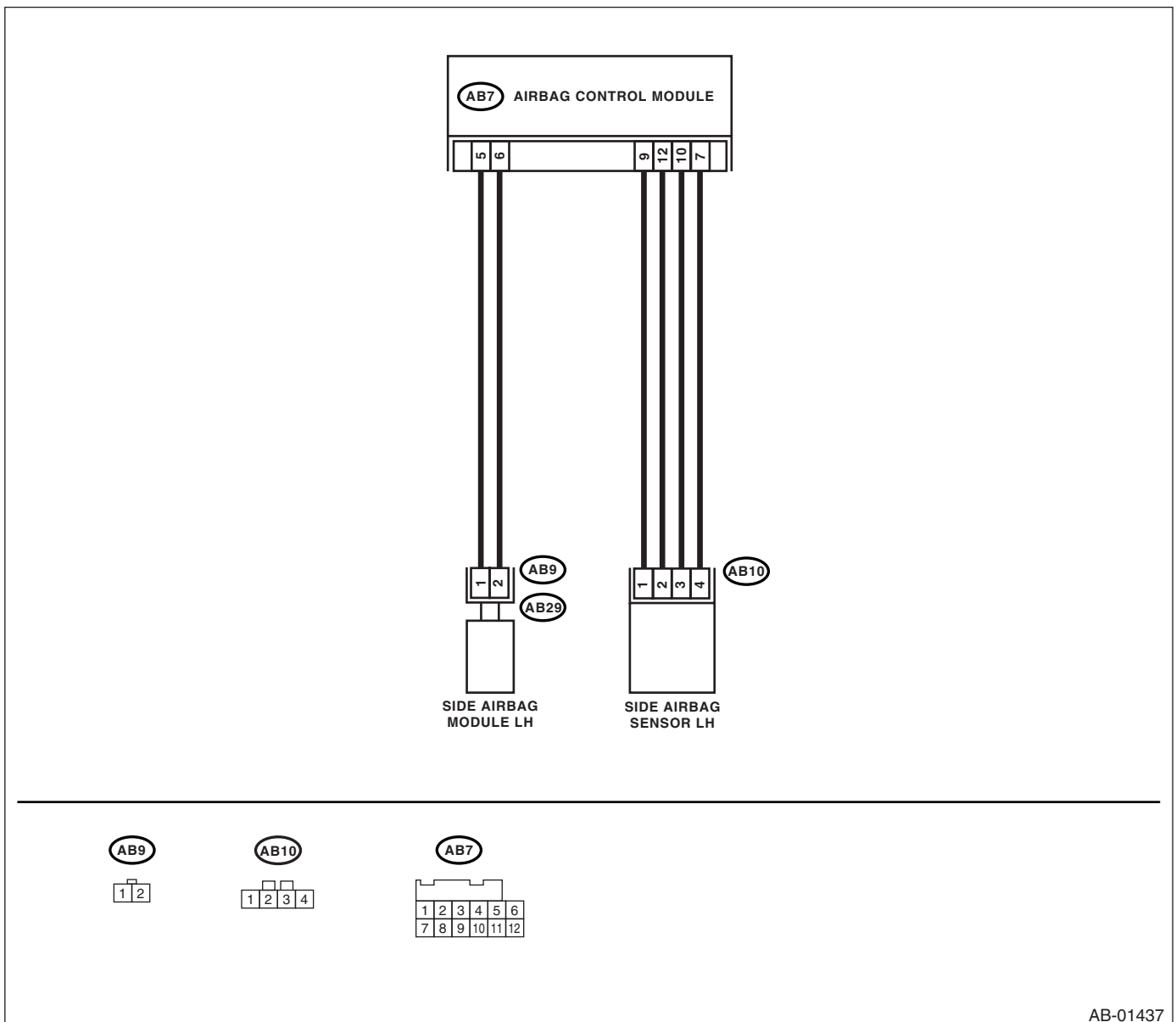

AB-01437

Diagnostic Chart with Trouble Code

AIRBAG SYSTEM (DIAGNOSTICS)

Step	Check	Yes	No
1 CHECK POOR CONTACT OF CONNECTORS. Check the connector between airbag control module, and side airbag module LH and side airbag sensor LH for poor contact.	Is there poor contact?	Replace the side airbag harness with body harness.	Go to step 2.
2 CHECK SIDE AIRBAG MODULE. 1) Turn the ignition switch to OFF, disconnect the battery ground cable, and wait more than 20 seconds. 2) Disconnect the connector (AB9) from side airbag module (LH), and connect the connector (1F) in test harness F to connector (AB9). 3) Connect the airbag resistor to connector (3F) in test harness F. 4) Connect the battery ground cable, and turn the ignition switch to ON.	Does the airbag warning light illuminate for 6 seconds then go off?	Replace the front seat with side airbag module (LH). <Ref. to SE-7, Front Seat.>	Go to step 3.
3 CHECK SIDE AIRBAG HARNESS (LH). 1) Turn the ignition switch to OFF, disconnect the battery ground cable, and wait more than 20 seconds. 2) Disconnect the connector (AB19) from seat belt pretensioner (LH). 3) Disconnect the airbag resistor from the test harness. 4) Disconnect the connector (AB7) from the airbag control module. 5) Connect the connector (1R) in test harness R to the connector (AB7). 6) Connect the battery ground cable, and turn the ignition switch to ON. 7) Measure the voltage between connector (3R) in test harness R and the chassis ground. Connector & terminal (3R) No. 10 (+) — Chassis ground (-): (3R) No. 12 (+) — Chassis ground (-):	Is the voltage less than 1 V?	Go to step 4.	Replace the side airbag harness with body harness.
4 CHECK AIRBAG CONTROL MODULE. 1) Connect all connectors. 2) Erase the memory. 3) Perform the inspection mode. 4) Read out the DTC.	Is the same DTC displayed?	Replace the airbag control module. <Ref. to AB-18, Airbag Control Module.>	Go to step 5.
5 CHECK FOR ANY OTHER DTC ON DISPLAY.	Is any other DTC displayed?	Using the List of Diagnostic Trouble Code (DTC), check the DTC. <Ref. to AB(diag)-45, List of Diagnostic Trouble Code (DTC).>	Finish the diagnosis.

Diagnostic Chart with Trouble Code

AIRBAG SYSTEM (DIAGNOSTICS)

AA:DTC 51 SIDE AIRBAG RH FAILURE

DTC DETECTING CONDITION:

- Side airbag sensor (RH) is faulty.
- Side airbag harness (RH) is faulty.
- Airbag control module is faulty.

CAUTION:

- Before diagnosing the airbag system, be sure to turn the ignition switch to OFF, disconnect the ground cable from battery, and wait more than 20 seconds before starting to work.
- Before replacing the airbag module, seat belt pretensioner, roll connector, control module, and sensor, reconnect each part and confirm that the warning light operates properly.
- When inspecting the airbag main harness, disconnect the driver's airbag module and passenger's airbag module connectors for safety reasons.
- When inspecting the side airbag harness, disconnect the side airbag module connector and seat belt pretensioner connector for the safety reasons.

WIRING DIAGRAM:

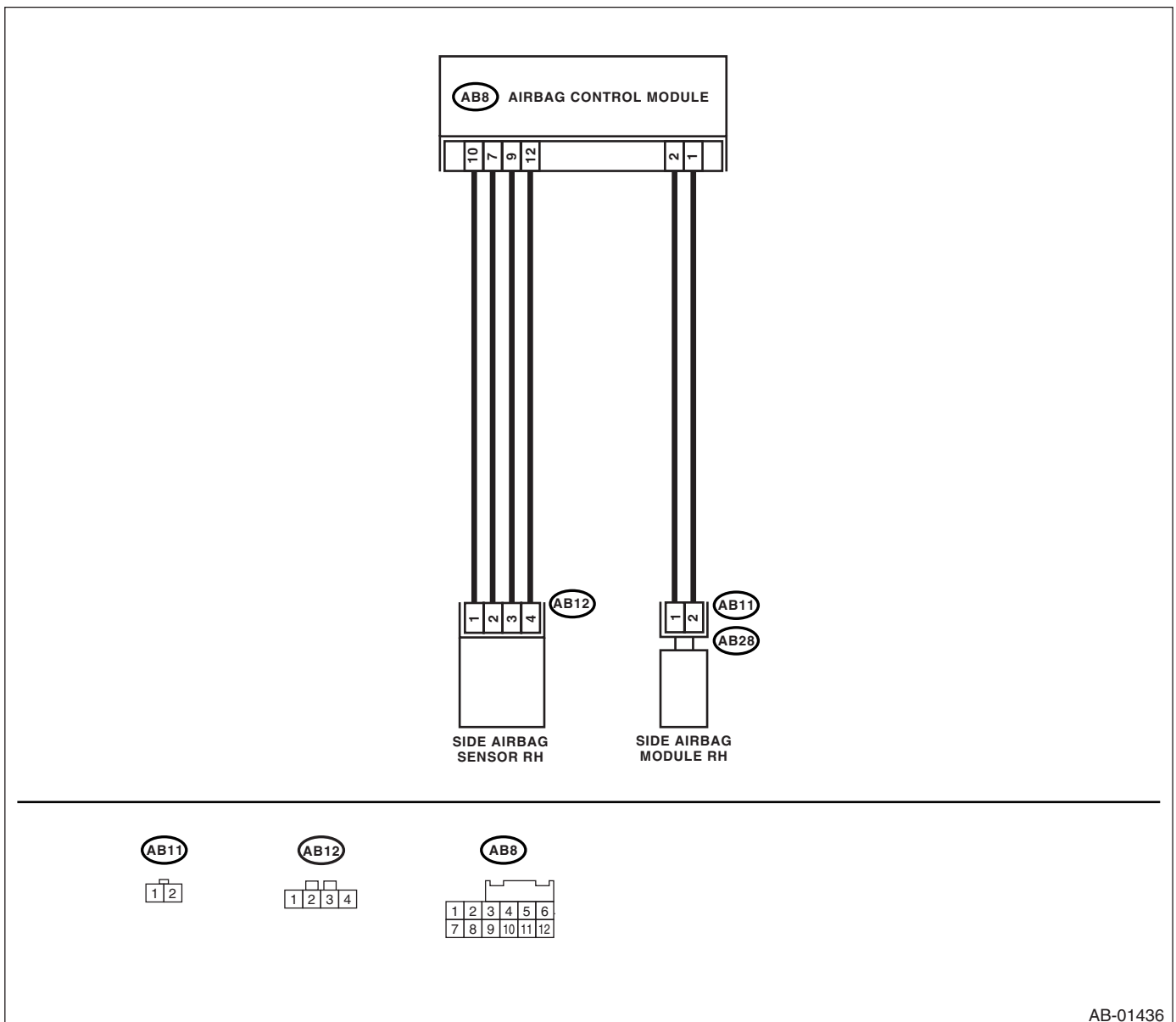

AB-01436

Diagnostic Chart with Trouble Code

AIRBAG SYSTEM (DIAGNOSTICS)

Step	Check	Yes	No
1 CHECK POOR CONTACT OF CONNECTORS. Check the connector between airbag control module, and side airbag module RH and side airbag sensor RH for poor contact.	Is there poor contact?	Replace the side airbag harness with body harness.	Go to step 2.
2 CHECK SIDE AIRBAG HARNESS (RH). 1) Turn the ignition switch to OFF, disconnect the battery ground cable, and wait more than 20 seconds. 2) Disconnect the connector (AB20) from seat belt pretensioner (RH). 3) Disconnect the connector (AB8) from the airbag control module. 4) Connect the connector (1R) in test harness R to connector (AB8). 5) Disconnect the connector (AB20) from the side airbag sensor (RH), and connect the connector (2V) in test harness V to connector (AB20). 6) Measure the resistance between connector (4R) in test harness R and the connector (3V) in test harness V. Connector & terminal (4R) No. 5 — (3V) No. 2: (4R) No. 6 — (3V) No. 4: (4R) No. 7 — (3V) No. 1: (4R) No. 8 — (3V) No. 5:	Is the resistance less than 10 Ω?	Go to step 3.	Replace the side airbag harness with body harness.
3 CHECK SIDE AIRBAG HARNESS. Measure the resistance between connector (4R) terminals in test harness R, and between connector (4R) in test harness R and chassis ground. Connector & terminal (4R) No. 5 — (4R) No. 7: (4R) No. 5 — (4R) No. 6: (4R) No. 5 — (4R) No. 8: (4R) No. 6 — (4R) No. 7: (4R) No. 6 — (4R) No. 8: (4R) No. 7 — (4R) No. 8: (4R) No. 5 — Chassis ground: (4R) No. 6 — Chassis ground: (4R) No. 7 — Chassis ground: (4R) No. 8 — Chassis ground:	Is the resistance more than 1 MΩ?	Go to step 4.	Replace the side airbag harness with body harness.
4 CHECK AIRBAG CONTROL MODULE. 1) Connect all connectors. 2) Erase the memory. 3) Perform the inspection mode. 4) Read out the DTC.	Is the same DTC displayed?	Replace the side airbag sensor (RH). <Ref. to AB-19, Side Airbag Sensor.>When the problem is not corrected after sensor replacement, replace the airbag control module. <Ref. to AB-18, Airbag Control Module.>	Go to step 5.

Diagnostic Chart with Trouble Code

AIRBAG SYSTEM (DIAGNOSTICS)

Step	Check	Yes	No
5 CHECK FOR ANY OTHER DTC ON DISPLAY.	Is any other DTC displayed?	Using the List of Diagnostic Trouble Code (DTC), check the DTC. <Ref. to AB(diag)-45, List of Diagnostic Trouble Code (DTC).>	Finish the diagnosis.

Diagnostic Chart with Trouble Code

AIRBAG SYSTEM (DIAGNOSTICS)

AB:DTC 52 SIDE AIRBAG SENSOR LH FAILURE

DTC DETECTING CONDITION:

- Side airbag sensor (LH) is faulty.
- Side airbag harness (LH) is faulty.
- Airbag control module is faulty.

CAUTION:

- Before diagnosing the airbag system, be sure to turn the ignition switch to OFF, disconnect the ground cable from battery, and wait more than 20 seconds before starting to work.
- Before replacing the airbag module, seat belt pretensioner, roll connector, control module, and sensor, reconnect each part and confirm that the warning light operates properly.
- When inspecting the airbag main harness, disconnect the driver's airbag module and passenger's airbag module connectors for safety reasons.
- When inspecting the side airbag harness, disconnect the side airbag module connector and seat belt pretensioner connector for the safety reasons.

WIRING DIAGRAM:

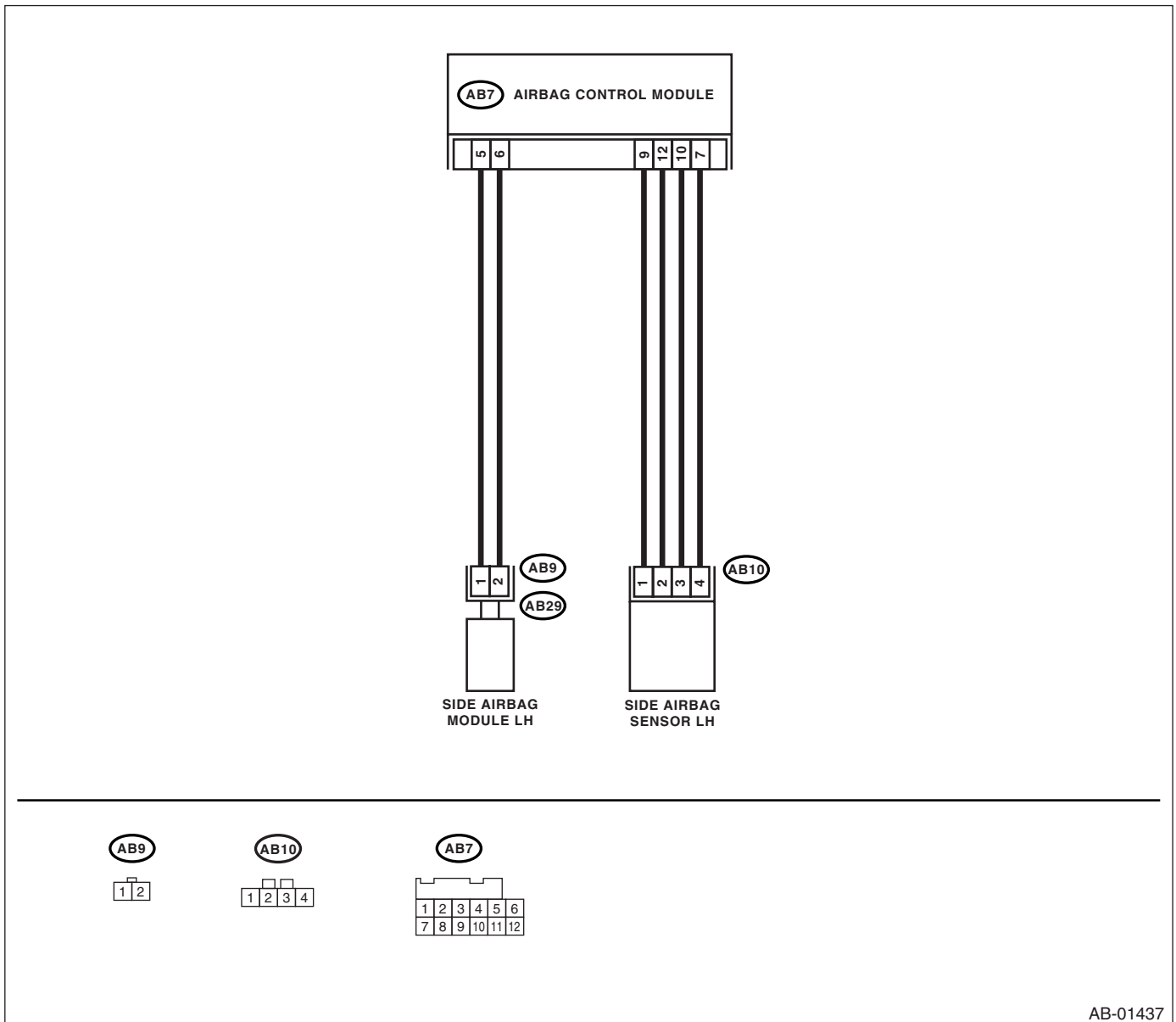

AB-01437

Diagnostic Chart with Trouble Code

AIRBAG SYSTEM (DIAGNOSTICS)

Step	Check	Yes	No
1 CHECK POOR CONTACT OF CONNECTORS. Check the connector between airbag control module, and side airbag module LH and side airbag sensor LH for poor contact.	Is there poor contact?	Replace the side airbag harness with body harness.	Go to step 2.
2 CHECK SIDE AIRBAG HARNESS (LH). 1) Turn the ignition switch to OFF, disconnect the battery ground cable, and wait more than 20 seconds. 2) Disconnect the connector (AB19) from seat belt pretensioner (LH). 3) Disconnect the connector (AB9) from side airbag module (LH). 4) Disconnect the connector (AB7) from the airbag control module. 5) Connect the connector (1R) in test harness R to the connector (AB7). 6) Disconnect the connector (AB10) from the side airbag sensor (LH), and connect the connector (2V) in test harness V to connector (AB10). 7) Measure the resistance between connector (4R) in test harness R and the connector (3V) in test harness V. Connector & terminal (4R) No. 4 — (3V) No. 2: (4R) No. 3 — (3V) No. 4: (4R) No. 2 — (3V) No. 1: (4R) No. 1 — (3V) No. 5:	Is the resistance less than 10 Ω ?	Go to step 3.	Replace the side airbag harness with body harness.
3 CHECK SIDE AIRBAG HARNESS (LH). Measure the resistance between connector (4R) terminals in test harness R, and between connector (4R) in test harness R and chassis ground. Connector & terminal (4R) No. 4 — (4R) No. 3: (4R) No. 4 — (4R) No. 2: (4R) No. 4 — (4R) No. 1: (4R) No. 3 — (4R) No. 2: (4R) No. 3 — (4R) No. 1: (4R) No. 2 — (4R) No. 1: (4R) No. 4 — Chassis ground: (4R) No. 3 — Chassis ground: (4R) No. 2 — Chassis ground: (4R) No. 1 — Chassis ground:	Is the resistance more than 1 M Ω ?	Go to step 4.	Replace the side airbag harness with body harness.
4 CHECK AIRBAG CONTROL MODULE. 1) Connect all connectors. 2) Erase the memory. 3) Perform the inspection mode. 4) Read out the DTC.	Is the same DTC displayed?	Replace the side airbag sensor (LH). <Ref. to AB-19, Side Airbag Sensor.>When the problem is not corrected after sensor replacement, replace the airbag control module. <Ref. to AB-18, Airbag Control Module.>	Go to step 5.

Diagnostic Chart with Trouble Code

AIRBAG SYSTEM (DIAGNOSTICS)

Step	Check	Yes	No
5 CHECK FOR ANY OTHER DTC ON DISPLAY.	Is any other DTC displayed?	Using the List of Diagnostic Trouble Code (DTC), check the DTC. <Ref. to AB(diag)-45, List of Diagnostic Trouble Code (DTC).>	Finish the diagnosis.

AC:DTC 53 SIDE AIRBAG RH FAILURE

DTC DETECTING CONDITION:

Side airbag sensor (RH) is faulty.

When Code 53 is displayed, the circuit within the side airbag sensor (RH) is faulty. Replace the side airbag sensor (RH).

<Ref. to AB-19, Side Airbag Sensor.>

AD:DTC 54 SIDE AIRBAG SENSOR LH FAILURE

DTC DETECTING CONDITION:

Side airbag sensor (LH) is faulty.

When Code 54 is displayed, the circuit within the side airbag sensor (LH) is faulty. Replace the side airbag sensor (LH).

<Ref. to AB-19, Side Airbag Sensor.>

AE:DTC 55 SIDE CURTAIN AIRBAG FIRING OUTPUT

This DTC is displayed when the side airbag is deployed.

When this DTC is displayed, the memory cannot be erased. Replace the following parts.

- Airbag control module <Ref. to AB-18, Airbag Control Module.>
- Front seat with side airbag module (Operating side) <Ref. to SE-7, Front Seat.>
- Side airbag sensor (Operating side) <Ref. to AB-19, Side Airbag Sensor.>

Diagnostic Chart with Trouble Code

AIRBAG SYSTEM (DIAGNOSTICS)

AF:DTC 61 BELT PRETENSIONER RH FAILURE

DTC DETECTING CONDITION:

- Seat belt pretensioner (RH) circuit is open, shorted or shorted to ground.
- Airbag control module is faulty.
- Pretensioner is faulty.
- Pretensioner harness is faulty.

CAUTION:

- Before diagnosing the airbag system, be sure to turn the ignition switch to OFF, disconnect the ground cable from battery, and wait more than 20 seconds before starting to work.
- Before replacing the airbag module, seat belt pretensioner, roll connector, control module, and sensor, reconnect each part and confirm that the warning light operates properly.
- When inspecting the side airbag harness, disconnect the side airbag module connector and seat belt pretensioner connector for the safety reasons.

WIRING DIAGRAM:

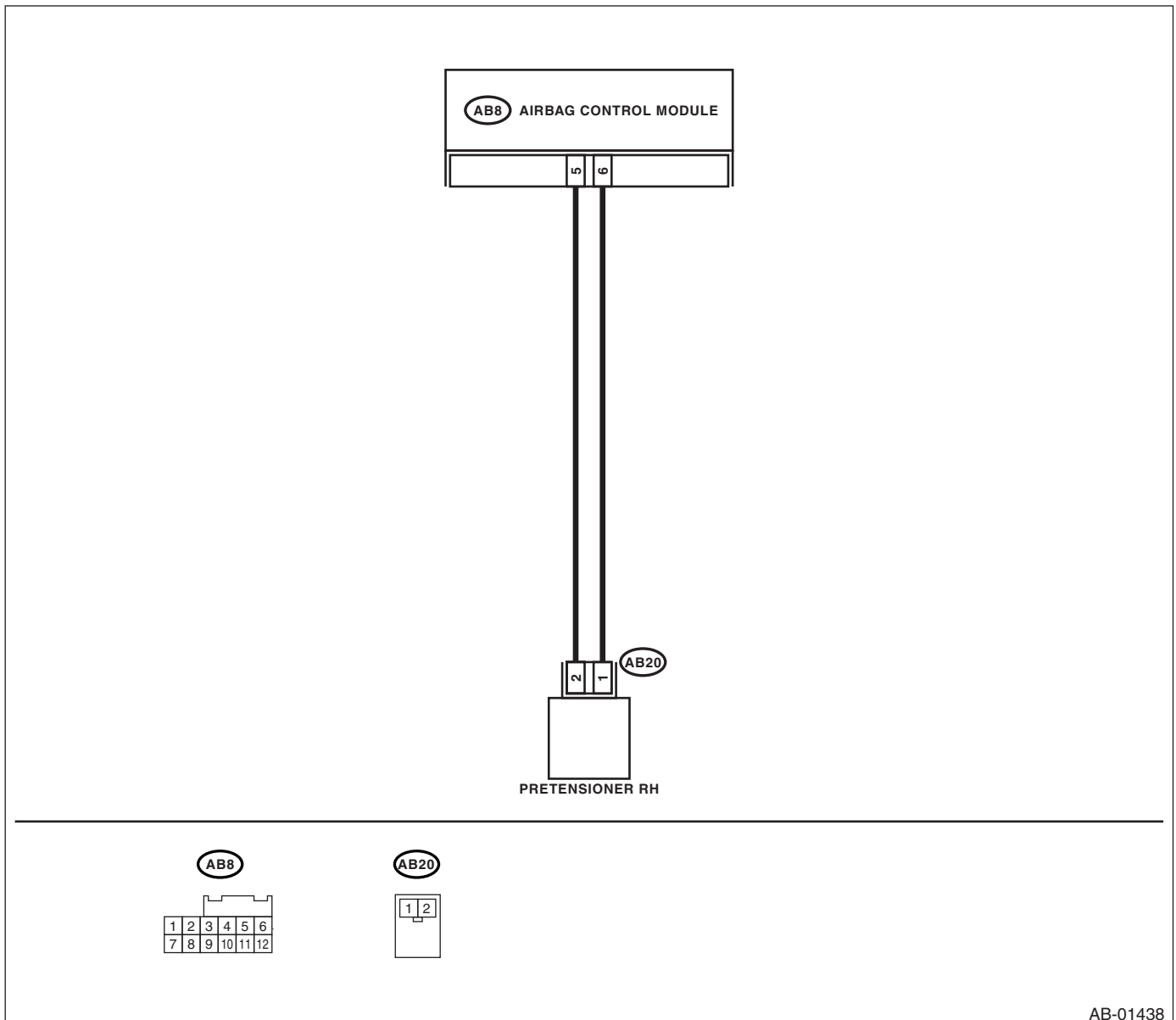

AB-01438

Diagnostic Chart with Trouble Code

AIRBAG SYSTEM (DIAGNOSTICS)

Step	Check	Yes	No
1 CHECK POOR CONTACT OF CONNECTORS. Check the connector between airbag control module and seat belt pretensioner RH for poor contact.	Is there poor contact?	Replace the side airbag harness with body harness.	Go to step 2.
2 CHECK SEAT BELT PRETENSIONER. 1) Turn the ignition switch to OFF, disconnect the battery ground cable, and wait more than 20 seconds. 2) Disconnect the connector (AB20) from seat belt pretensioner (RH). 3) Connect the connector (1N) in test harness N to connector (AB20). 4) Connect the airbag resistor to the connector (2N) in test harness N. 5) Connect the battery ground cable, and turn the ignition switch to ON.	Does the airbag warning light illuminate for 6 seconds then go off?	Replace the seat belt pretensioner (RH). <Ref. to SB-10, Front Seat Belt.>	Go to step 3.
3 CHECK SIDE AIRBAG HARNESS (RH). 1) Turn the ignition switch to OFF, disconnect the battery ground cable, and wait more than 20 seconds. 2) Disconnect the airbag resistor from the test harness. 3) Disconnect the connector (AB11) from side airbag module (RH). 4) Disconnect the connectors (AB7) and (AB8) from the airbag control module. 5) Connect the connector (1R) in test harness R to the connector (AB8). 6) Measure the resistance between connector (3R) in test harness R and the connector (2N) in test harness N. Connector & terminal (3R) No. 17 — (2N) No. 2: (3R) No. 19 — (2N) No. 1:	Is the resistance less than 10 Ω ?	Go to step 4.	Replace the side airbag harness with body harness.
4 CHECK SIDE AIRBAG HARNESS (RH). Measure the resistance between the connector (3R) terminals in test harness R. Connector & terminal (3R) No. 17 — (3R) No. 19:	Is the resistance more than 1 M Ω ?	Go to step 5.	Replace the side airbag harness with body harness.
5 CHECK SIDE AIRBAG HARNESS (RH). Measure the resistance between connector (3R) in test harness R and the chassis ground. Connector & terminal (3R) No. 17 — Chassis ground: (3R) No. 19 — Chassis ground:	Is the resistance more than 1 M Ω ?	Go to step 6.	Replace the side airbag harness with body harness.
6 CHECK AIRBAG CONTROL MODULE. 1) Connect all connectors. 2) Erase the memory. 3) Perform the inspection mode. 4) Read out the DTC.	Is the same DTC displayed?	Replace the airbag control module. <Ref. to AB-18, Airbag Control Module.>	Go to step 7.
7 CHECK FOR ANY OTHER DTC ON DISPLAY.	Is any other DTC displayed?	Using the List of Diagnostic Trouble Code (DTC), check the DTC. <Ref. to AB(diag)-45, List of Diagnostic Trouble Code (DTC).>	Finish the diagnosis.

Diagnostic Chart with Trouble Code

AIRBAG SYSTEM (DIAGNOSTICS)

AG:DTC 62 BELT PRETENSIONER LH FAILURE

DTC DETECTING CONDITION:

- Seat belt pretensioner (LH) circuit is open, shorted or shorted to ground.
- Airbag control module is faulty.
- Pretensioner is faulty.
- Pretensioner harness is faulty.

CAUTION:

- Before diagnosing the airbag system, be sure to turn the ignition switch to OFF, disconnect the ground cable from battery, and wait more than 20 seconds before starting to work.
- Before replacing the airbag module, seat belt pretensioner, roll connector, control module, and sensor, reconnect each part and confirm that the warning light operates properly.
- When inspecting the side airbag harness, disconnect the side airbag module connector and seat belt pretensioner connector for the safety reasons.

WIRING DIAGRAM:

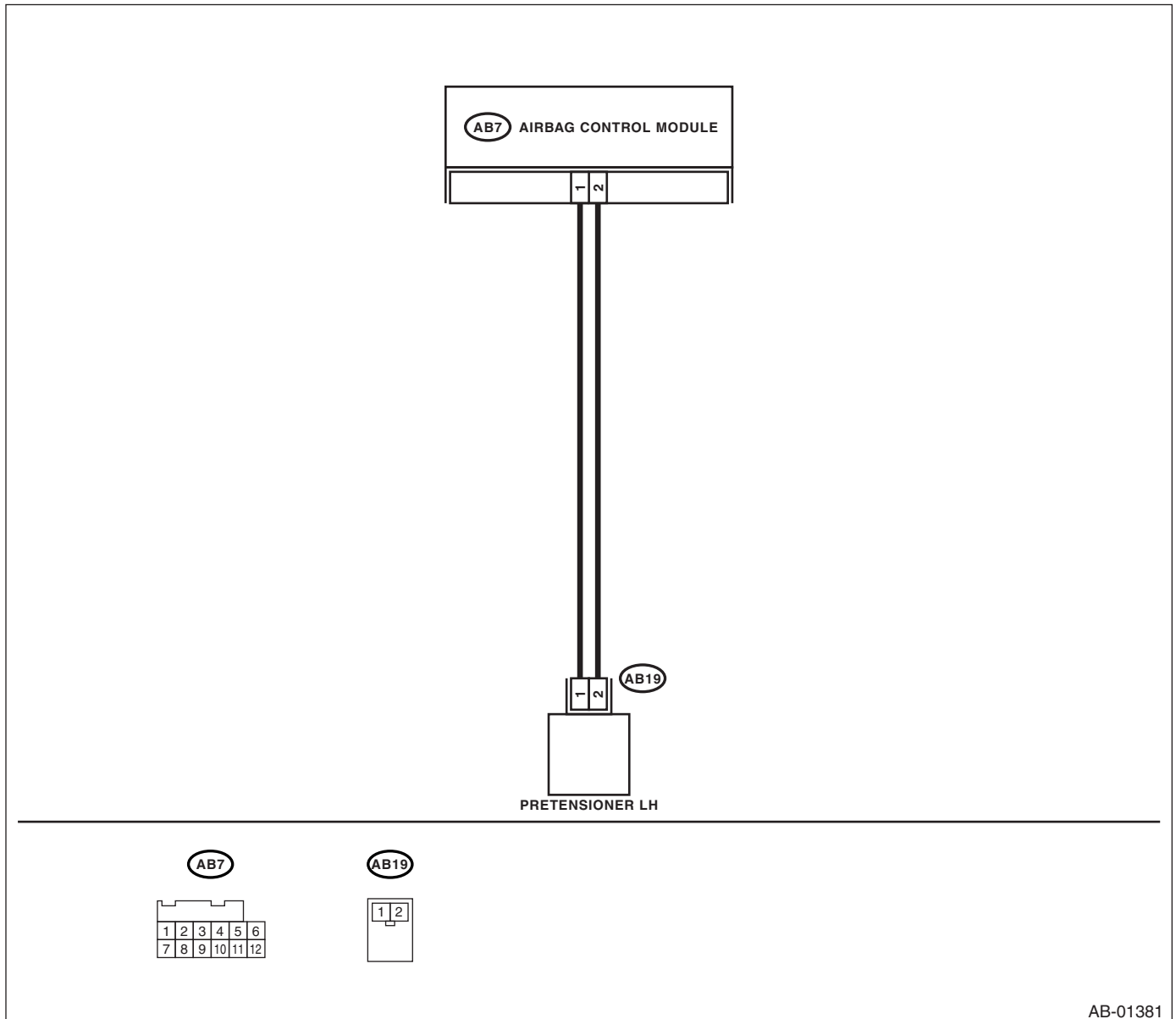

Diagnostic Chart with Trouble Code

AIRBAG SYSTEM (DIAGNOSTICS)

Step	Check	Yes	No
1 CHECK POOR CONTACT OF CONNECTORS. Check the connector between airbag control module and seat belt pretensioner LH for poor contact.	Is there poor contact?	Replace the side airbag harness with body harness.	Go to step 2.
2 CHECK SEAT BELT PRETENSIONER. 1) Turn the ignition switch to OFF, disconnect the battery ground cable, and wait more than 20 seconds. 2) Disconnect the connector (AB19) from seat belt pretensioner (LH). 3) Connect the connector (1N) in test harness N to connector (AB19). 4) Connect the airbag resistor to the connector (2N) in test harness N. 5) Connect the battery ground cable, and turn the ignition switch to ON.	Does the airbag warning light illuminate for 6 seconds then go off?	Replace the seat belt pretensioner (LH). <Ref. to SB-10, Front Seat Belt.>	Go to step 3.
3 CHECK SIDE AIRBAG HARNESS (LH). 1) Turn the ignition switch to OFF, disconnect the battery ground cable, and wait more than 20 seconds. 2) Disconnect the airbag resistor from the test harness. 3) Disconnect the connector (AB9) from side airbag module (LH). 4) Disconnect the connectors (AB7) and (AB8) from the airbag control module. 5) Connect the connector (1R) in test harness R to the connector (AB7). 6) Measure the resistance between connector (3R) in test harness R and the connector (2N) in test harness N. Connector & terminal (3R) No. 11 — (2N) No. 2: (3R) No. 13 — (2N) No. 1:	Is the resistance less than 10 Ω?	Go to step 4.	Replace the side airbag harness with body harness.
4 CHECK SIDE AIRBAG HARNESS (LH). Measure the resistance between the connector (3R) terminals in test harness R. Connector & terminal (3R) No. 11 — (3R) No. 13:	Is the resistance more than 1 MΩ?	Go to step 5.	Replace the side airbag harness with body harness.
5 CHECK SIDE AIRBAG HARNESS (LH). Measure the resistance between connector (3R) in test harness R and the chassis ground. Connector & terminal (3R) No. 11 — Chassis ground: (3R) No. 13 — Chassis ground:	Is the resistance more than 1 MΩ?	Go to step 6.	Replace the side airbag harness with body harness.
6 CHECK AIRBAG CONTROL MODULE. 1) Connect all connectors. 2) Erase the memory. 3) Perform the inspection mode. 4) Read out the DTC.	Is the same DTC displayed?	Replace the airbag control module. <Ref. to AB-18, Airbag Control Module.>	Go to step 7.
7 CHECK FOR ANY OTHER DTC ON DISPLAY.	Is any other DTC displayed?	Using the List of Diagnostic Trouble Code (DTC), check the DTC. <Ref. to AB(diag)-45, List of Diagnostic Trouble Code (DTC).>	Finish the diagnosis.

Diagnostic Chart with Trouble Code

AIRBAG SYSTEM (DIAGNOSTICS)

AH:DTC 65 BELT PRETENSIONER RH FAILURE

DTC DETECTING CONDITION:

- Seat belt pretensioner (RH) circuit is shorted to the power supply.
- Pretensioner is faulty.
- Pretensioner harness is faulty.
- Airbag control module is faulty.

CAUTION:

- Before diagnosing the airbag system, be sure to turn the ignition switch to OFF, disconnect the ground cable from battery, and wait more than 20 seconds before starting to work.
- Before replacing the airbag module, seat belt pretensioner, roll connector, control module, and sensor, reconnect each part and confirm that the warning light operates properly.
- When inspecting the side airbag harness, disconnect the side airbag module connector and seat belt pretensioner connector for the safety reasons.

WIRING DIAGRAM:

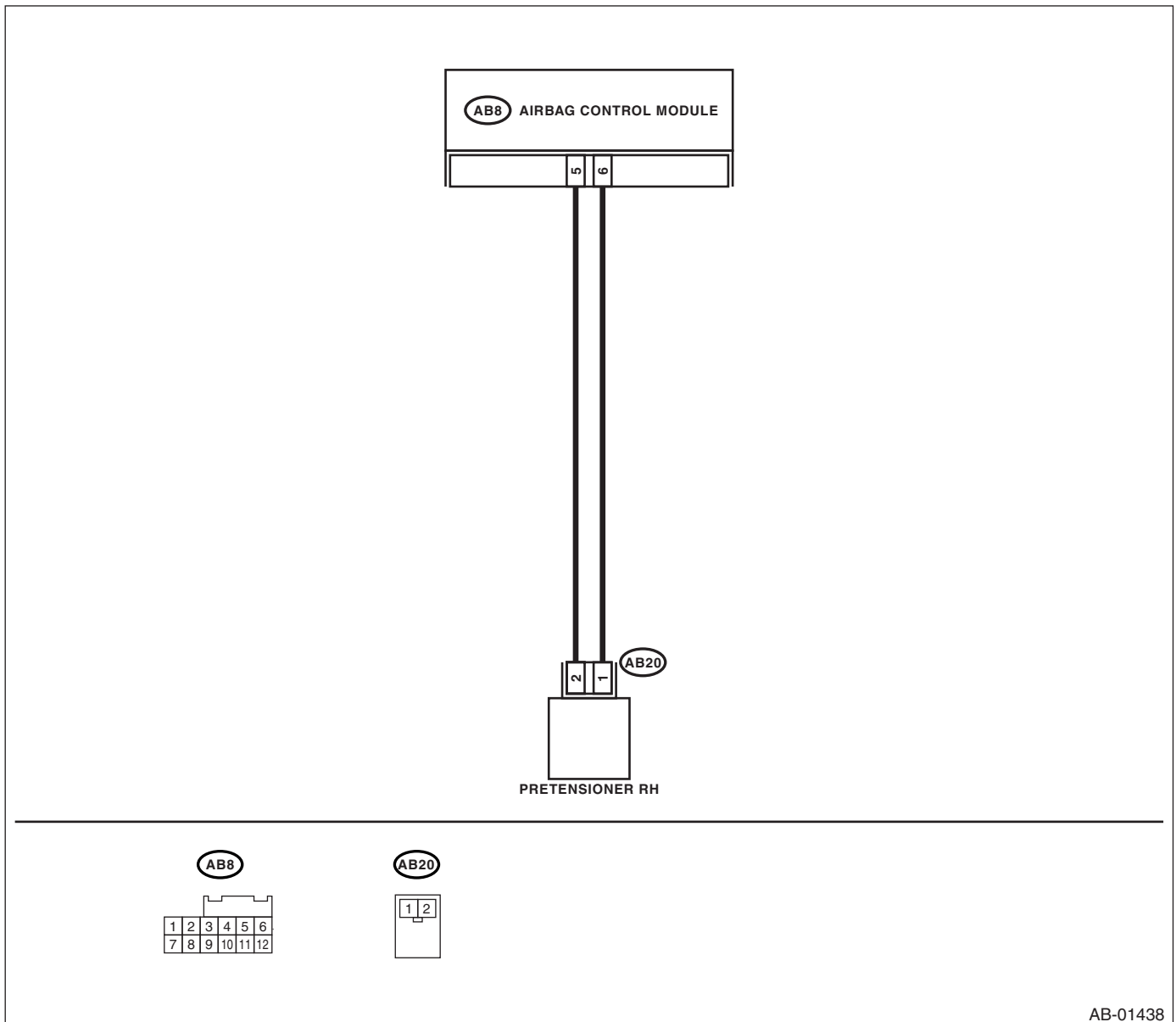

Diagnostic Chart with Trouble Code

AIRBAG SYSTEM (DIAGNOSTICS)

Step	Check	Yes	No
1 CHECK POOR CONTACT OF CONNECTORS. Check the connector between airbag control module and seat belt pretensioner RH for poor contact.	Is there poor contact?	Replace the side airbag harness with body harness.	Go to step 2.
2 CHECK SEAT BELT PRETENSIONER. 1) Turn the ignition switch to OFF, disconnect the battery ground cable, and wait more than 20 seconds. 2) Disconnect the connector (AB20) from seat belt pretensioner (RH). 3) Connect the connector (1N) in test harness N to connector (AB20). 4) Connect the airbag resistor to the connector (2N) in test harness N. 5) Connect the battery ground cable, and turn the ignition switch to ON.	Does the airbag warning light illuminate for 6 seconds then go off?	Replace the seat belt pretensioner (RH). <Ref. to SB-10, Front Seat Belt.>	Go to step 3.
3 CHECK SIDE AIRBAG HARNESS (RH). 1) Turn the ignition switch to OFF, disconnect the battery ground cable, and wait more than 20 seconds. 2) Disconnect the airbag resistor from the test harness. 3) Disconnect the connector (AB11) from side airbag module (RH). 4) Disconnect the connectors (AB7) and (AB8) from the airbag control module. 5) Connect the connector (1R) in test harness R to the connector (AB8). 6) Connect the battery ground cable, and turn the ignition switch to ON. 7) Measure the voltage between connector (3R) in test harness R and the chassis ground. Connector & terminal <i>(3R) No. 17 (+) — Chassis ground (-):</i> <i>(3R) No. 19 (+) — Chassis ground (-):</i>	Is the voltage less than 1 V?	Go to step 4.	Replace the side airbag harness with body harness.
4 CHECK AIRBAG CONTROL MODULE. 1) Connect all connectors. 2) Erase the memory. 3) Perform the inspection mode. 4) Read out the DTC.	Is the same DTC displayed?	Replace the airbag control module. <Ref. to AB-18, Airbag Control Module.>	Go to step 5.
5 CHECK FOR ANY OTHER DTC ON DISPLAY.	Is any other DTC displayed?	Using the List of Diagnostic Trouble Code (DTC), check the DTC. <Ref. to AB(diag)-45, List of Diagnostic Trouble Code (DTC).>	Finish the diagnosis.

Diagnostic Chart with Trouble Code

AIRBAG SYSTEM (DIAGNOSTICS)

AI: DTC 66 BELT PRETENSIONER LH FAILURE

DTC DETECTING CONDITION:

- Seat belt pretensioner (LH) circuit is shorted to the power supply.
- Pretensioner is faulty.
- Pretensioner harness is faulty.
- Airbag control module is faulty.

CAUTION:

- Before diagnosing the airbag system, be sure to turn the ignition switch to OFF, disconnect the ground cable from battery, and wait more than 20 seconds before starting to work.
- Before replacing the airbag module, seat belt pretensioner, roll connector, control module and the sensor, reconnect each part and confirm that the warning light operates properly.
- When inspecting the side airbag harness, disconnect the side airbag module connector and seat belt pretensioner connector for the safety reasons.

WIRING DIAGRAM:

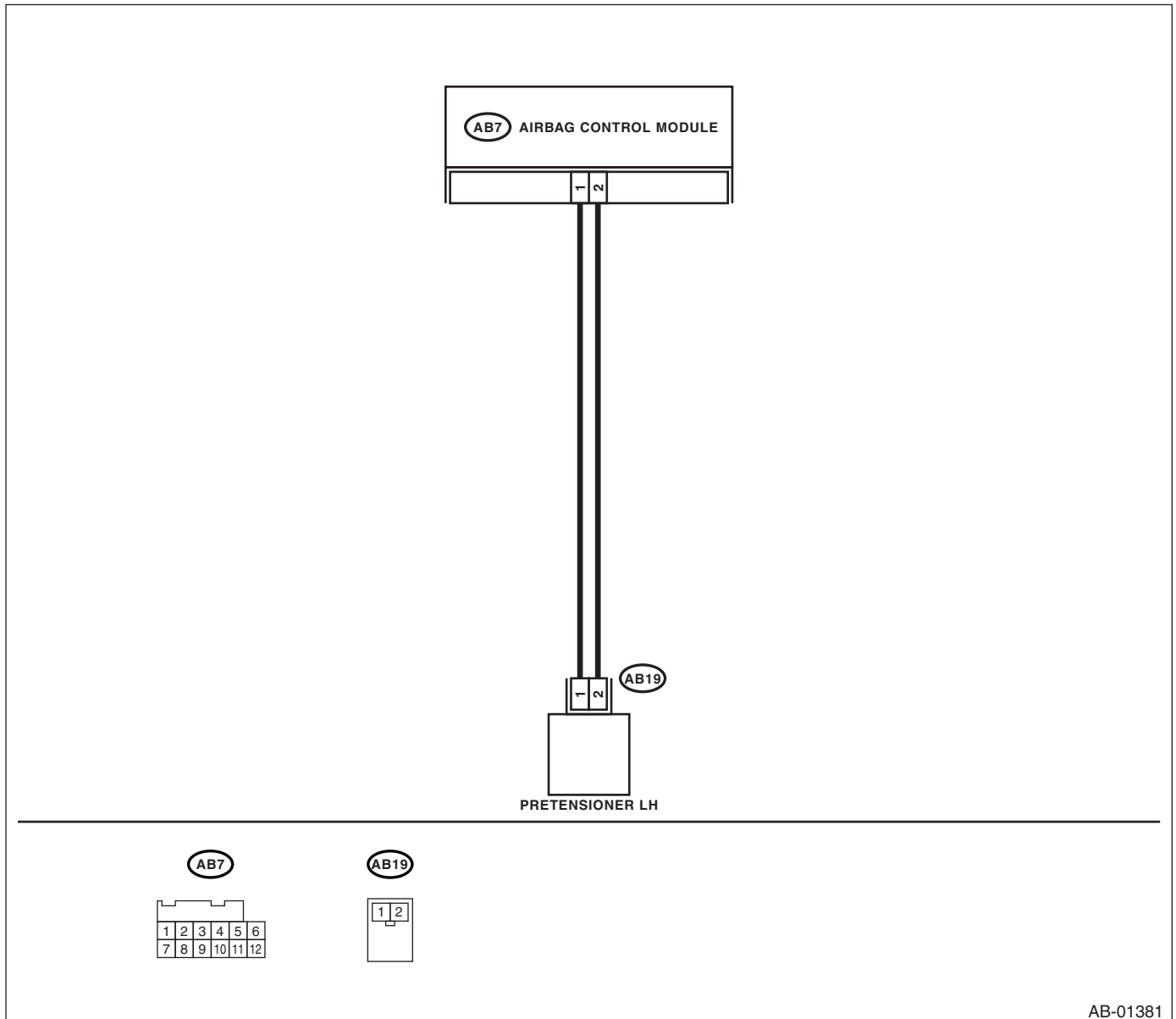

AB-01381

Diagnostic Chart with Trouble Code

AIRBAG SYSTEM (DIAGNOSTICS)

Step	Check	Yes	No
1 CHECK POOR CONTACT OF CONNECTORS. Check the connector between airbag control module and seat belt pretensioner LH for poor contact.	Is there poor contact?	Replace the side airbag harness with body harness.	Go to step 2.
2 CHECK SEAT BELT PRETENSIONER. 1) Turn the ignition switch to OFF, disconnect the battery ground cable, and wait more than 20 seconds. 2) Disconnect the connector (AB19) from seat belt pretensioner (LH). 3) Connect the connector (1N) in test harness N to connector (AB19). 4) Connect the airbag resistor to the connector (2N) in test harness N. 5) Connect the battery ground cable, and turn the ignition switch to ON.	Does the airbag warning light illuminate for 6 seconds then go off?	Replace the seat belt pretensioner (LH). <Ref. to SB-10, Front Seat Belt.>	Go to step 3.
3 CHECK SIDE AIRBAG HARNESS (LH). 1) Turn the ignition switch to OFF, disconnect the battery ground cable, and wait more than 20 seconds. 2) Disconnect the airbag resistor from the test harness. 3) Disconnect the connector (AB9) from side airbag module (LH). 4) Disconnect the connectors (AB7) and (AB8) from the airbag control module. 5) Connect the connector (1R) in test harness R to the connector (AB7). 6) Connect the battery ground cable, and turn the ignition switch to ON. 7) Measure the voltage between connector (3R) in test harness R and the chassis ground. Connector & terminal <i>(3R) No. 11 (+) — Chassis ground (-):</i> <i>(3R) No. 13 (+) — Chassis ground (-):</i>	Is the voltage less than 1 V?	Go to step 4.	Replace the side airbag harness with body harness.
4 CHECK AIRBAG CONTROL MODULE. 1) Connect all connectors. 2) Erase the memory. 3) Perform the inspection mode. 4) Read out the DTC.	Is the same DTC displayed?	Replace the airbag control module. <Ref. to AB-18, Airbag Control Module.>	Go to step 5.
5 CHECK FOR ANY OTHER DTC ON DISPLAY.	Is any other DTC displayed?	Using the List of Diagnostic Trouble Code (DTC), check the DTC. <Ref. to AB(diag)-45, List of Diagnostic Trouble Code (DTC).>	Finish the diagnosis.

Diagnostic Chart with Trouble Code

AIRBAG SYSTEM (DIAGNOSTICS)

AJ:DTC 71 DRIVER'S AIRBAG FAILURE

DTC DETECTING CONDITION:

- Airbag main harness circuit is open, shorted or shorted to ground.
- Airbag module harness (Driver) circuit is open, shorted or shorted to ground.
- Roll connector circuit is open, shorted or shorted to ground.
- Driver's airbag module is faulty.
- Airbag control module is faulty.

CAUTION:

- Before diagnosing the airbag system, be sure to turn the ignition switch to OFF, disconnect the ground cable from battery, and wait more than 20 seconds before starting to work.
- Before replacing the airbag module, seat belt pretensioner, roll connector, control module and the sensor, reconnect each part and confirm that the warning light operates properly.
- When inspecting the airbag main harness, disconnect the driver's airbag module and passenger's airbag module connectors, and seat belt pretensioner for safety reasons.

NOTE:

Prior to work, prepare two airbag resistors (98299PA040).

WIRING DIAGRAM:

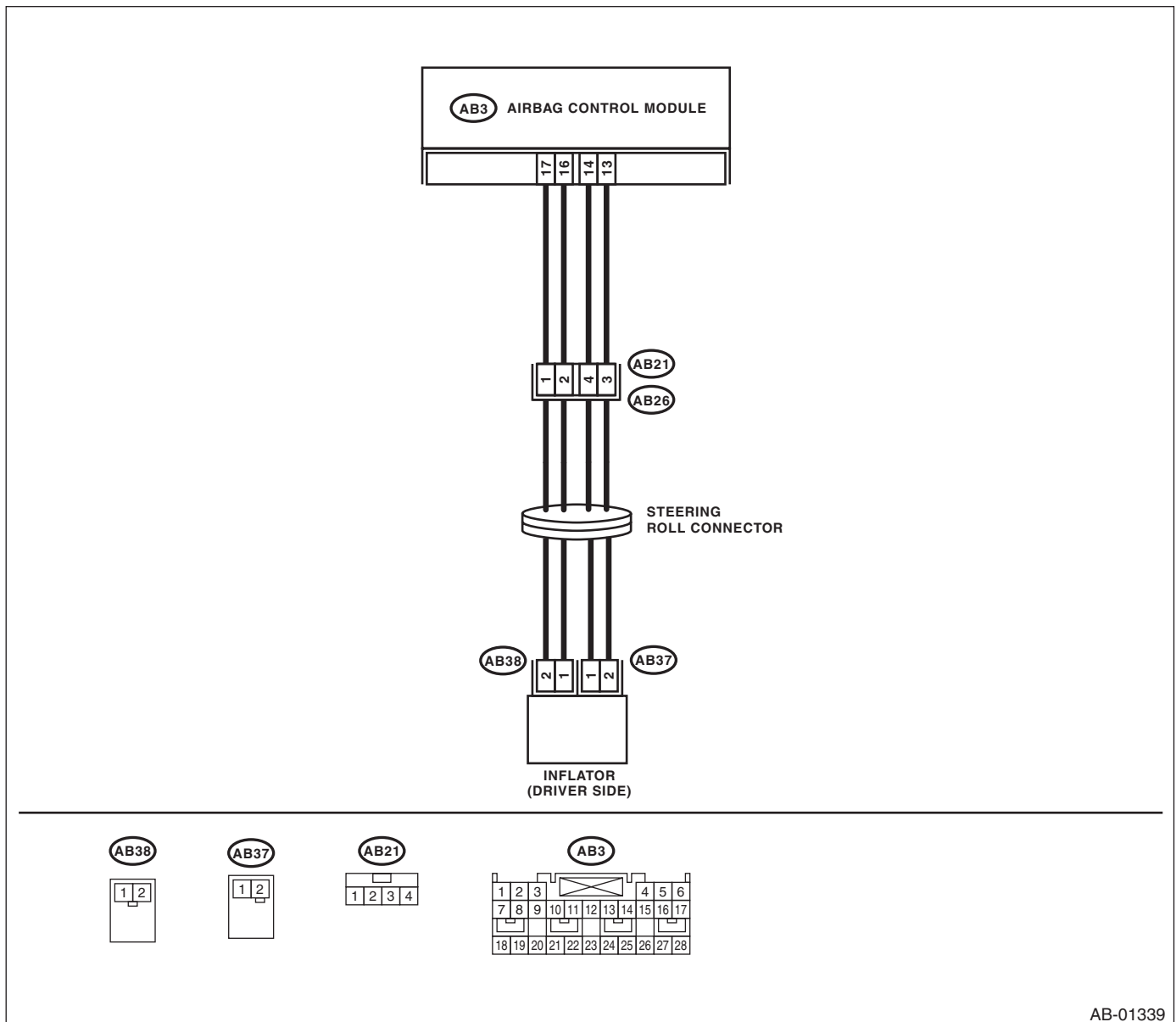

AB-01339

Diagnostic Chart with Trouble Code

AIRBAG SYSTEM (DIAGNOSTICS)

Step	Check	Yes	No
1 CHECK POOR CONTACT OF CONNECTORS. Check the connector between airbag control module and driver's airbag module for poor contact.	Is there poor contact?	Replace the airbag main harness with body harness.	Go to step 2.
2 CHECK DRIVER'S AIRBAG MODULE. 1) Turn the ignition switch to OFF, disconnect the battery ground cable, and wait more than 20 seconds. 2) Remove the driver's airbag module. 3) Connect the connector (1N) in test harness N to connector (AB38). 4) Connect the airbag resistor to the connector (2N) in test harness N. 5) Connect the connector (1Q) in test harness Q to connector (AB 37). 6) Connect the airbag resistor to connector (2Q) in test harness Q. 7) Connect the battery ground cable, and turn the ignition switch to ON.	Does the airbag warning light illuminate for 6 seconds then go off?	Replace the driver's airbag module. <Ref. to AB-14, Driver's Airbag Module.>	Go to step 3.
3 CHECK ROLL CONNECTOR. 1) Turn the ignition switch to OFF, disconnect the battery ground cable, and wait more than 20 seconds. 2) Disconnect the test harness N from connector (AB38). 3) Disconnect the test harness Q from connector (AB37). 4) Remove the instrument panel lower cover and disconnect the connector (AB26) from (AB21). 5) Connect the connector (1P) in test harness P to connector (AB21). 6) Connect the airbag resistor to connectors (2P) and (3P) in test harness P. 7) Connect the battery ground cable, and turn the ignition switch to ON.	Does the airbag warning light illuminate for 6 seconds then go off?	Replace the roll connector. <Ref. to AB-20, Roll Connector.>	Go to step 4.
4 CHECK AIRBAG MAIN HARNESS (DRIVER'S AIRBAG HARNESS). 1) Turn the ignition switch to OFF, disconnect the battery ground cable, and wait more than 20 seconds. 2) Disconnect the airbag resistor from connectors (2P) and (3P) in test harness P. 3) Remove the instrument panel side cover on passenger side, and disconnect the connectors (AB4) and (AB27). 4) Disconnect the connector (AB3) from the airbag control module, and connect the connector (1R) in test harness U. 5) Measure the resistance between connector (2R) in test harness R and connectors (2P) and (3P) in test harness P. Connector & terminal (2R) No. 2 — (2P) No. 1: (2R) No. 4 — (2P) No. 2: (2R) No. 8 — (3P) No. 3: (2R) No. 12 — (3P) No. 3:	Is the resistance less than 10 Ω ?	Go to step 5.	Replace the airbag main harness with body harness.

Diagnostic Chart with Trouble Code

AIRBAG SYSTEM (DIAGNOSTICS)

Step	Check	Yes	No
<p>5 CHECK AIRBAG MAIN HARNESS (DRIVER'S AIRBAG HARNESS). Measure the resistance between connector (2R) terminals in test harness R, and between connector (2R) and chassis ground.</p> <p>Connector & terminal <i>(2R) No. 2 — (2R) No. 4:</i> <i>(2R) No. 4 — Chassis ground:</i> <i>(2R) No. 2 — Chassis ground:</i> <i>(2R) No. 8 — (2R) No. 12:</i> <i>(2R) No. 8 — Chassis ground:</i> <i>(2R) No. 12 — Chassis ground:</i> <i>(2R) No. 2 — (2R) No. 8:</i> <i>(2R) No. 2 — (2R) No. 12:</i> <i>(2R) No. 4 — (2R) No. 8:</i> <i>(2R) No. 4 — (2R) No. 12:</i></p>	Is the resistance more than 1 MΩ?	Go to step 6.	Replace the airbag main harness with body harness.
<p>6 CHECK AIRBAG CONTROL MODULE. 1) Connect all connectors. 2) Erase the memory. 3) Perform the inspection mode. 4) Read out the DTC.</p>	Is the same DTC displayed?	Replace the airbag control module. <Ref. to AB-18, Airbag Control Module.>	Go to step 7.
<p>7 CHECK FOR ANY OTHER DTC ON DISPLAY.</p>	Is any other DTC displayed?	Using the List of Diagnostic Trouble Code (DTC), check the DTC. <Ref. to AB(diag)-45, List of Diagnostic Trouble Code (DTC).>	Finish the diagnosis.

Diagnostic Chart with Trouble Code

AIRBAG SYSTEM (DIAGNOSTICS)

AK:DTC 72 PASSENGER'S AIRBAG FAILURE

DTC DETECTING CONDITION:

- Airbag harness is open, shorted or shorted to ground.
- Airbag module (Passenger) circuit is open, shorted or shorted to ground.
- Airbag control module is faulty.
- Passenger's airbag module is faulty.

CAUTION:

- Before diagnosing the airbag system, be sure to turn the ignition switch to OFF, disconnect the ground cable from battery, and wait more than 20 seconds before starting to work.
- When inspecting the airbag main harness, disconnect the driver's airbag module and passenger's airbag module for safety reasons.

WIRING DIAGRAM:

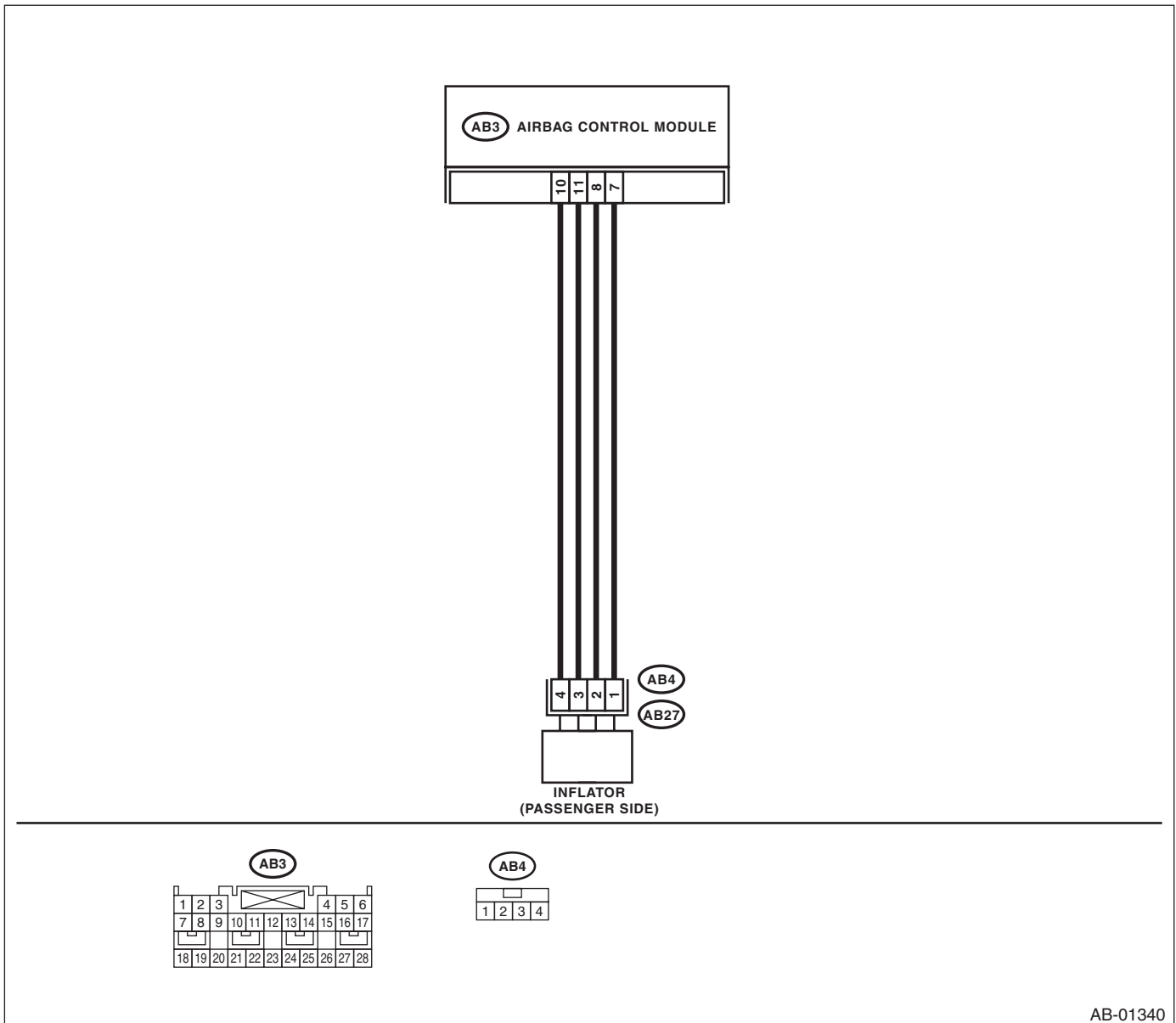

AB-01340

Diagnostic Chart with Trouble Code

AIRBAG SYSTEM (DIAGNOSTICS)

Step	Check	Yes	No
1 CHECK POOR CONTACT OF CONNECTORS. Check the connector between airbag control module and passenger's airbag module for poor contact.	Is there poor contact?	Replace the airbag main harness with body harness.	Go to step 2.
2 CHECK PASSENGER'S AIRBAG MODULE. 1) Turn the ignition switch to OFF, disconnect the ground cable from battery, and wait for more than 20 seconds before starting work. 2) Remove the glove box. 3) Disconnect the connector of passenger's airbag module from (AB4). 4) Connect the connector (1P) in test harness P to connector (AB4). 5) Connect the two airbag resistors to connectors (2P) and (3P) in test harness P. 6) Connect the battery ground cable, and turn the ignition switch to ON.	Does the airbag warning light illuminate for 6 seconds then go off?	Replace the passenger's airbag module. <Ref. to AB-15, Passenger's Airbag Module.>	Go to step 3.
3 CHECK AIRBAG MAIN HARNESS. 1) Turn the ignition switch to OFF, disconnect the ground cable from battery, and wait for more than 20 seconds before starting work. 2) Disconnect the two airbag resistors from connectors (2P) and (3P) in test harness P. 3) Remove the lower cover and disconnect the connector (AB26) from (AB21). 4) Disconnect the connector (AB3) from the airbag control module, and connect the connector (1R) in test harness R. 5) Measure the resistance between connector (2R) in test harness R and the connectors (2P) (3P) in test harness P. Connector & terminal <i>(2R) No. 9 — (3P) No. 3:</i> <i>(2R) No. 13 — (3P) No. 4:</i> <i>(2R) No. 3 — (2P) No. 2:</i> <i>(2R) No. 5 — (2P) No. 1:</i>	Is the resistance less than 10 Ω?	Go to step 4.	Replace the airbag main harness with body harness.
4 CHECK AIRBAG MAIN HARNESS. Measure the resistance in the connector (2R) in test harness R. Connector & terminal <i>(2R) No. 9 — (2R) No. 13:</i> <i>(2R) No. 9 — Chassis ground:</i> <i>(2R) No. 13 — Chassis ground:</i> <i>(2R) No. 3 — (2R) No. 5:</i> <i>(2R) No. 3 — Chassis ground:</i> <i>(2R) No. 5 — Chassis ground:</i> <i>(2R) No. 3 — (2R) No. 9:</i> <i>(2R) No. 3 — (2R) No. 13:</i> <i>(2R) No. 5 — (2R) No. 9:</i> <i>(2R) No. 5 — (2R) No. 13:</i>	Is the resistance more than 1 MΩ?	Go to step 5.	Replace the airbag main harness with body harness.
5 CHECK AIRBAG CONTROL MODULE. 1) Connect all connectors. 2) Erase the memory. 3) Perform the inspection mode. 4) Read out the DTC.	Is the same DTC displayed?	Replace the airbag control module. <Ref. to AB-18, Airbag Control Module.>	Go to step 6.

Diagnostic Chart with Trouble Code

AIRBAG SYSTEM (DIAGNOSTICS)

Step	Check	Yes	No
6 CHECK FOR ANY OTHER DTC ON DISPLAY.	Is any other DTC displayed?	Using the List of Diagnostic Trouble Code (DTC), check the DTC. <Ref. to AB(diag)-45, List of Diagnostic Trouble Code (DTC).>	Finish the diagnosis.

Diagnostic Chart with Trouble Code

AIRBAG SYSTEM (DIAGNOSTICS)

AL:DTC 75 DRIVER'S AIRBAG FAILURE

DTC DETECTING CONDITION:

- Airbag main harness circuit (Driver) is shorted to the power supply.
- Airbag module harness (Driver) is shorted to the power supply.
- Roll connector is shorted to the power supply.
- Driver's airbag module is faulty.
- Airbag control module is faulty.

CAUTION:

- Before diagnosing the airbag system, be sure to turn the ignition switch to OFF, disconnect the ground cable from battery, and wait more than 20 seconds before starting to work.
- Before replacing the airbag module, seat belt pretensioner, roll connector, control module and the sensor, reconnect each part and confirm that the warning light operates properly.
- When inspecting the airbag main harness, disconnect the driver's airbag module and passenger's airbag module connectors, and seat belt pretensioner for safety reasons.

NOTE:

Prior to work, prepare two airbag resistors (98299PA040).

WIRING DIAGRAM:

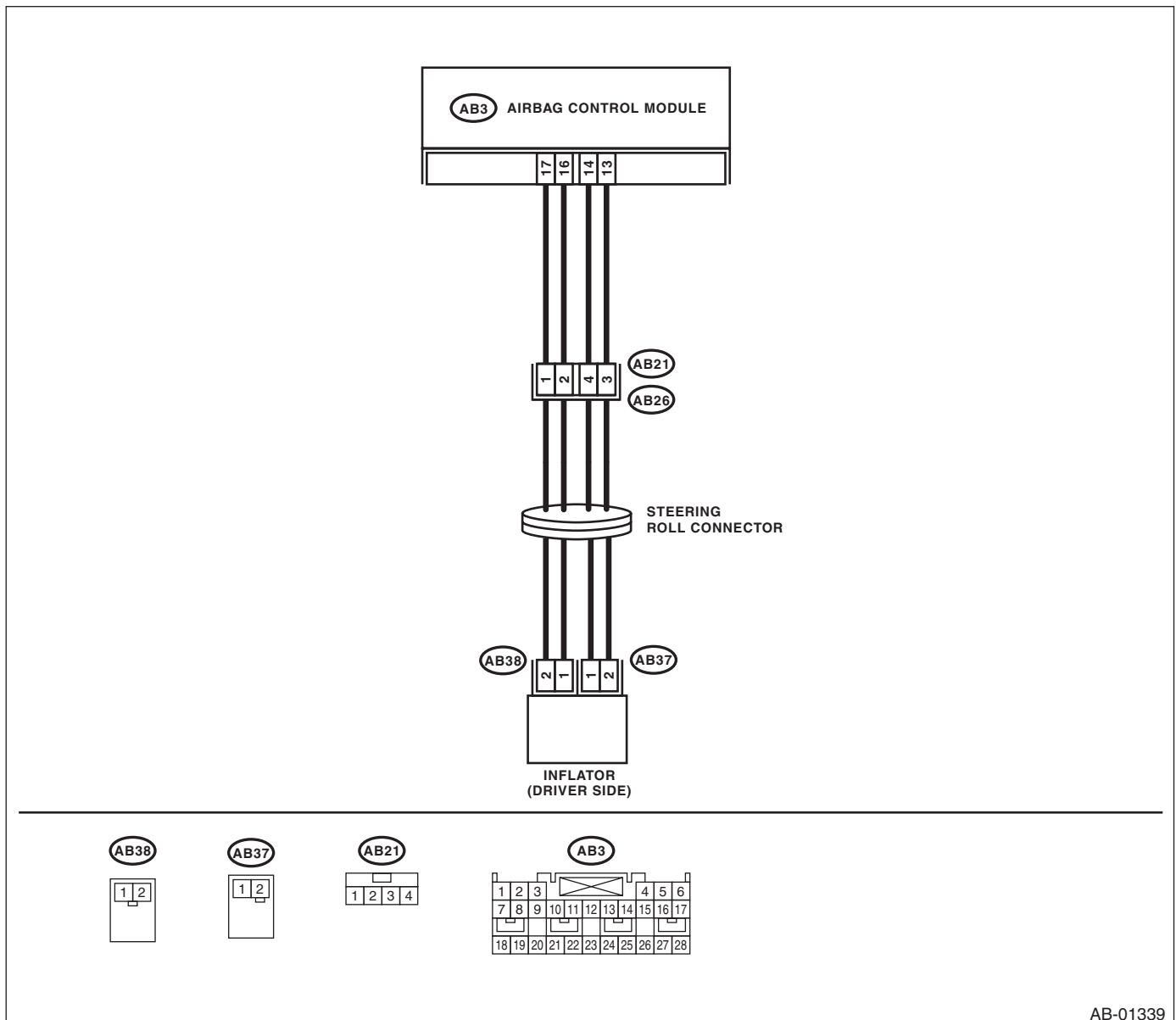

AB-01339

Diagnostic Chart with Trouble Code

AIRBAG SYSTEM (DIAGNOSTICS)

Step	Check	Yes	No
1 CHECK POOR CONTACT OF CONNECTORS. Check the connector between airbag control module and driver's airbag module for poor contact.	Is there poor contact?	Replace the airbag main harness with body harness.	Go to step 2.
2 CHECK DRIVER'S AIRBAG MODULE. 1) Turn the ignition switch to OFF, disconnect the battery ground cable, and wait more than 20 seconds. 2) Remove the driver's airbag module. 3) Connect the connector (AB 38) to connector (1N) in test harness N. 4) Connect the airbag resistor to the connector (2N) in test harness N. 5) Connect the connector (1Q) in test harness Q to connector (AB 37). 6) Connect the airbag resistor to connector (2Q) in test harness Q. 7) Connect the battery ground cable, and turn the ignition switch to ON.	Does the airbag warning light illuminate for 6 seconds then go off?	Replace the driver's airbag module. <Ref. to AB-14, Driver's Airbag Module.>	Go to step 3.
3 CHECK ROLL CONNECTOR. 1) Turn the ignition switch to OFF, disconnect the battery ground cable, and wait more than 20 seconds. 2) Disconnect the test harness N from connector (AB38). 3) Disconnect the test harness Q from connector (AB37). 4) Remove the instrument panel lower cover and disconnect the connector (AB26) from (AB21). 5) Connect the connector (1P) in test harness P to connector (AB21). 6) Connect the airbag resistor to connectors (2P) and (3P) in test harness P. 7) Connect the battery ground cable, and turn the ignition switch to ON.	Does the airbag warning light illuminate for 6 seconds then go off?	Replace the roll connector. <Ref. to AB-20, Roll Connector.>	Go to step 4.
4 CHECK AIRBAG MAIN HARNESS (DRIVER'S AIRBAG HARNESS). 1) Turn the ignition switch to OFF, disconnect the battery ground cable, and wait more than 20 seconds. 2) Disconnect the airbag resistor from connectors (2P) and (3P) in test harness P. 3) Remove the instrument panel side cover on passenger side, and disconnect the connectors (AB4) and (AB27). 4) Disconnect the connector (AB6) from the airbag control module, and connect the connector (1R) in test harness R. 5) Connect the battery ground cable, and turn the ignition switch to ON. (engine OFF) 6) Measure the voltage between connector (2R) in test harness R and chassis ground. Connector & terminal (2R) No. 4 — Chassis ground (-): (2R) No. 2 — Chassis ground (-): (2R) No. 8 — Chassis ground (-): (2R) No. 12 — Chassis ground (-):	Is the voltage less than 1 V?	Go to step 5.	Replace the airbag main harness with body harness.

Diagnostic Chart with Trouble Code

AIRBAG SYSTEM (DIAGNOSTICS)

Step	Check	Yes	No
5 CHECK AIRBAG CONTROL MODULE. 1) Connect all connectors. 2) Erase the memory. 3) Perform the inspection mode. 4) Read out the DTC.	Is the same DTC displayed?	Replace the airbag control module. <Ref. to AB-18, Airbag Control Module.>	Go to step 6 .
6 CHECK FOR ANY OTHER DTC ON DISPLAY.	Is any other DTC displayed?	Using the List of Diagnostic Trouble Code (DTC), check the DTC. <Ref. to AB(diag)-45, List of Diagnostic Trouble Code (DTC).>	Finish the diagnosis.

Diagnostic Chart with Trouble Code

AIRBAG SYSTEM (DIAGNOSTICS)

AM:DTC 76 PASSENGER'S AIRBAG FAILURE

DTC DETECTING CONDITION:

- Airbag main harness (Passenger) is shorted to the power supply.
- Airbag module harness (Passenger) is shorted to the power supply.
- Airbag control module is faulty.
- Passenger's airbag module is faulty.

CAUTION:

- Before diagnosing the airbag system, be sure to turn the ignition switch to OFF, disconnect the ground cable from battery, and wait more than 20 seconds before starting to work.
- When inspecting the airbag main harness, disconnect the driver's airbag module and passenger's airbag module for safety reasons.

WIRING DIAGRAM:

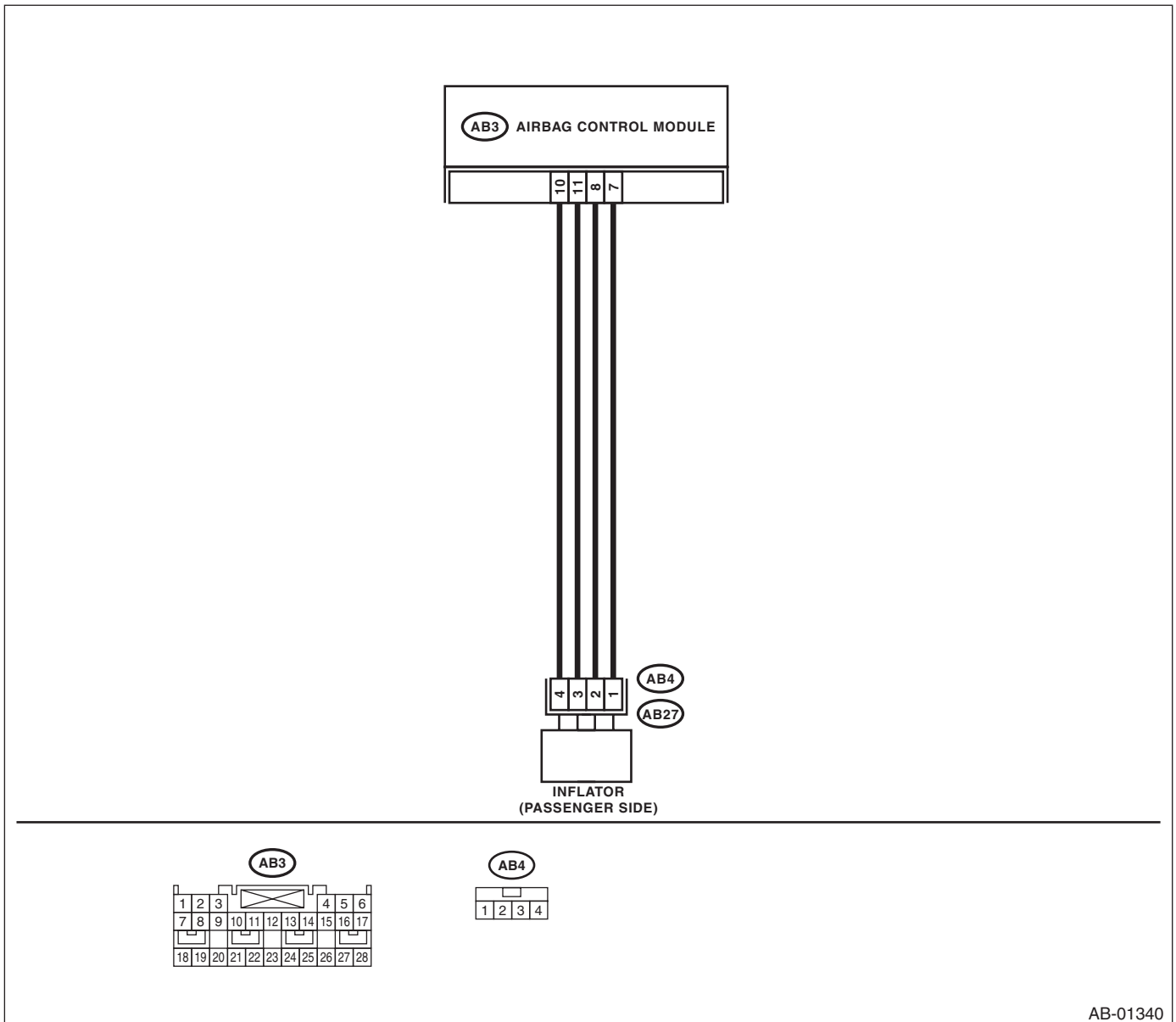

Diagnostic Chart with Trouble Code

AIRBAG SYSTEM (DIAGNOSTICS)

Step	Check	Yes	No
1 CHECK POOR CONTACT OF CONNECTORS. Check the connector between airbag control module and passenger's airbag module for poor contact.	Is there poor contact?	Replace the airbag main harness with body harness.	Go to step 2.
2 CHECK PASSENGER'S AIRBAG MODULE. 1) Turn the ignition switch to OFF, disconnect the ground cable from battery, and wait for more than 20 seconds before starting work. 2) Remove the glove box. 3) Disconnect the connector (AB4) from passenger's airbag module. 4) Connect the connector (1P) in test harness P to connector (AB4). 5) Connect the two airbag resistors to connectors (2P) and (3P) in test harness P. 6) Connect the battery ground cable, and turn the ignition switch to ON.	Does the airbag warning light illuminate for 6 seconds then go off?	Replace the passenger's airbag module. <Ref. to AB-15, Passenger's Airbag Module.>	Go to step 3.
3 CHECK AIRBAG MAIN HARNESS. 1) Turn the ignition switch to OFF, disconnect the ground cable from battery, and wait for more than 20 seconds before starting work. 2) Disconnect the two airbag resistors from connectors (2P) and (3P) in test harness P. 3) Remove the lower cover and disconnect the connector (AB21) from (AB26). 4) Disconnect the connector (AB3) from the airbag control module, and connect the connector (1R) in test harness R. 5) Connect the battery ground cable, and turn the ignition switch to ON. 6) Measure the voltage between connector (2R) in test harness R and chassis ground. Connector & terminal <i>(2R) No. 9 (+) — Chassis ground (-):</i> <i>(2R) No. 13 (+) — Chassis ground (-):</i> <i>(2R) No. 5 (+) — Chassis ground (-):</i> <i>(2R) No. 3 (+) — Chassis ground (-):</i>	Is the voltage less than 1 V?	Go to step 4.	Replace the airbag main harness with body harness.
4 CHECK AIRBAG CONTROL MODULE. 1) Connect all connectors. 2) Erase the memory. 3) Perform the inspection mode. 4) Read out the DTC.	Is the same DTC displayed?	Replace the airbag control module. <Ref. to AB-18, Airbag Control Module.>	Go to step 5.
5 CHECK FOR ANY OTHER DTC ON DISPLAY.	Is any other DTC displayed?	Using the List of Diagnostic Trouble Code (DTC), check the DTC. <Ref. to AB(diag)-45, List of Diagnostic Trouble Code (DTC).>	Finish the diagnosis.

Diagnostic Chart with Trouble Code

AIRBAG SYSTEM (DIAGNOSTICS)
