

3. Diagnosis System

A: CHECK ENGINE MALFUNCTION INDICATOR LAMP (MIL)

1. ACTIVATION OF CHECK ENGINE MALFUNCTION INDICATOR LAMP (MIL)

1) When ignition switch is turned to ON (engine off), the CHECK ENGINE malfunction indicator lamp (MIL) in the combination meter illuminates.

NOTE:

If the MIL does not illuminate, perform diagnostics of the CHECK ENGINE light circuit or the combination meter circuit. <Refer to "7. Diagnostics for CHECK ENGINE Malfunction Indicator Lamp (MIL), 2-7 [T700]" .>

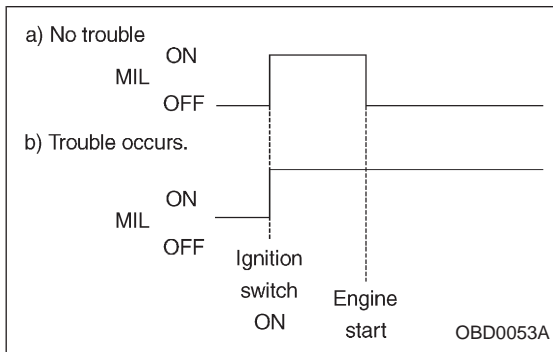

2) After starting the engine, the MIL goes out. If it does not, either the engine or the emission control system is malfunctioning.

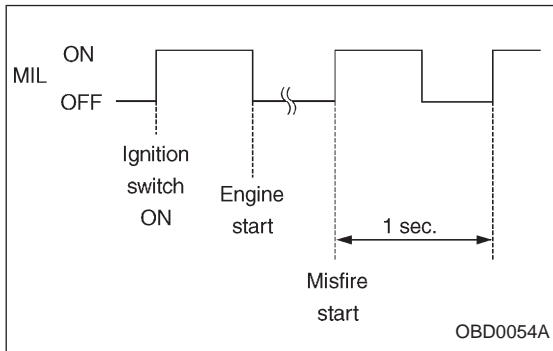

3) If the diagnosis system senses a misfire which could damage the catalyzer, the MIL will blink at a cycle of 1 Hz.

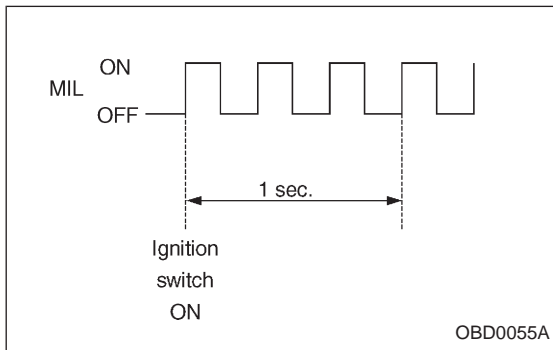

4) When ignition switch is turned to ON (engine off) or to "START" with the test mode connector connected, the MIL blinks at a cycle of 3 Hz.

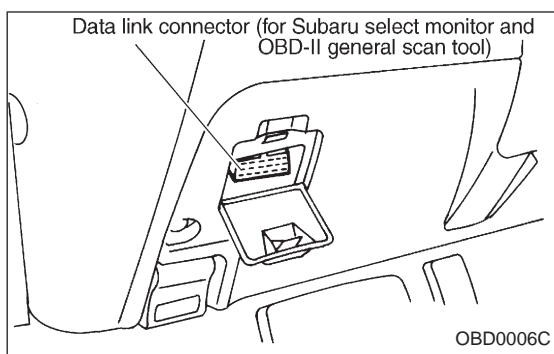

B: OBD-II GENERAL SCAN TOOL

1. HOW TO USE OBD-II GENERAL SCAN TOOL

- 1) Prepare a general scan tool (OBD-II general scan tool) required by SAE J1978.
- 2) Open the cover and connect the OBD-II general scan tool to the data link connector located in the lower portion of the instrument panel (on the driver's side), to the lower cover.
- 3) Using the OBD-II general scan tool, call up diagnostic trouble code(s) and freeze frame data.

OBD-II general scan tool functions consist of:

- (1) MODE \$01: Current powertrain diagnostic data
- (2) MODE \$02: Powertrain freeze frame data
- (3) MODE \$03: Emission-related powertrain diagnostic trouble codes
- (4) MODE \$04: Clear/Reset emission-related diagnostic information
- (5) MODE \$05: Oxygen sensor monitoring test results

Read out data according to repair procedures.

(For detailed operation procedures, refer to the OBD-II General Scan Tool Operation Manual.)

NOTE:

For details concerning diagnostic trouble codes, refer to the DIAGNOSTIC TROUBLE CODE (DTC) LIST, 2-7 [T10A0].

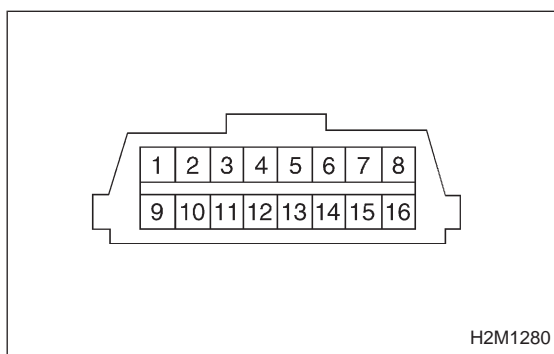

2. DATA LINK CONNECTOR (FOR OBD-II GENERAL SCAN TOOL AND SUBARU SELECT MONITOR)

- 1) This connector is used both for OBD-II general scan tools and the Subaru Select Monitor.
- 2) Terminal No. 4 to No. 6 of the data link connector is used for the Subaru Select Monitor signal.

CAUTION:

Do not connect any scan tools other than the OBD-II general scan tools and the Subaru Select Monitor, because the circuit for the Subaru Select Monitor may be damaged.

Terminal No.	Contents	Terminal No.	Contents
1	Power supply	9	Blank
2	Blank	10	K line of ISO 9141 CARB
3	Blank	11	Blank
4	Subaru Select Monitor signal (ECM to Subaru Select Monitor)*	12	Ground
5	Subaru Select Monitor signal (Subaru Select Monitor to ECM)*	13	Ground
6	Subaru Select Monitor clock*	14	Blank
7	Blank	15	Blank
8	Blank	16	Blank

*: Circuit only for Subaru Select Monitor

3. CURRENT POWERTRAIN DIAGNOSTIC DATA (MODE \$01)

Refers to data denoting the current operating condition of analog input/output, digital input/output and/or the powertrain system.

A list of the support data and PID (Parameter Identification) codes are shown in the following table.

PID	Data	Unit of measure
01	Number of emission-related powertrain trouble codes and MIL status	ON/OFF
03	Fuel system control status	—
04	Calculated engine load value	%
05	Engine coolant temperature	°C
06	Short term fuel trim	%
07	Long term fuel trim	%
0B	Intake manifold absolute pressure	kPa
0C	Engine revolution	rpm
0D	Vehicle speed	km/h
0E	Ignition timing advance	°
10	Air flow rate from mass air flow sensor	g/sec
11	Throttle valve opening angle	%
13	Check whether oxygen sensor is installed.	—
14	Oxygen sensor output voltage and short term fuel trim associated with oxygen sensor—bank 1	V and %
15	Oxygen sensor output voltage and short term fuel trim associated with oxygen sensor—bank 2	V and %
1C	On-board diagnosis system	—

NOTE:

Refer to OBD-II general scan tool manufacturer's instruction manual to access generic OBD-II PIDs (MODE \$01).

4. POWERTRAIN FREEZE FRAME DATA (MODE \$02)

Refers to data denoting the operating condition when trouble is sensed by the on-board diagnosis system.

A list of the support data and PID (Parameter Identification) codes are shown in the following table.

PID	Data	Unit of measure
02	Trouble code that caused CARB required freeze frame data storage	—
03	Fuel system control status	—
04	Calculated engine load value	%
05	Engine coolant temperature	°C
06	Short term fuel trim	%
07	Long term fuel trim	%
0B	Intake manifold absolute pressure	kPa
0C	Engine revolution	rpm
0D	Vehicle speed	km/h

NOTE:

Refer to OBD-II general scan tool manufacturer's instruction manual to access freeze frame data (MODE \$02).

5. EMISSION-RELATED POWERTRAIN DIAGNOSTIC TROUBLE CODE (MODE \$03)

Refers to data denoting emission-related powertrain diagnostic trouble codes.

For details concerning diagnostic trouble codes, refer to the DIAGNOSTIC TROUBLE CODE (DTC) LIST, 2-7 [T10A0].

NOTE:

Refer to OBD-II general scan tool manufacturer's instruction manual to access emission-related powertrain diagnostic trouble codes (MODE \$03).

6. CLEAR/RESET EMISSION-RELATED DIAGNOSTIC INFORMATION (MODE \$04)

Refers to the mode used to clear or reset emission-related diagnostic information (OBD-II trouble diagnostic information).

NOTE:

Refer to OBD-II general scan tool manufacturer's instruction manual to clear or reset emission-related diagnostic information (MODE \$04).

7. OXYGEN SENSOR MONITORING TEST RESULTS (MODE \$05)

Refers to the mode using oxygen sensor output data while the on-board diagnosis system is performing diagnosis on the oxygen sensor.

A list of the support oxygen sensor output data and test ID (identification) are shown in the following table.

Test ID	Data	Unit of measure
01	Rich to lean sensor threshold voltage (constant)	V
02	Lean to rich sensor threshold voltage (constant)	V
03	Low sensor voltage for switch time calculation (constant)	V
04	High sensor voltage for switch time calculation (constant)	V
05	Rich to lean sensor switch time (calculated)	sec.
06	Lean to rich sensor switch time (calculated)	sec.
07	Minimum sensor voltage for test cycle (calculated)	V
08	Maximum sensor voltage for test cycle (calculated)	V

NOTE:

Refer to OBD-II general scan tool manufacturer's instruction manual to access oxygen sensor monitoring test results (MODE \$05).

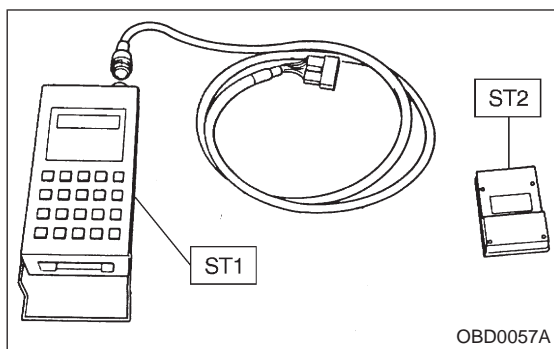

C: SUBARU SELECT MONITOR

1. HOW TO USE SUBARU SELECT MONITOR

1) Prepare Subaru select monitor and cartridge.

ST1 498307500 SELECT MONITOR KIT

ST2 498345700 CARTRIDGE

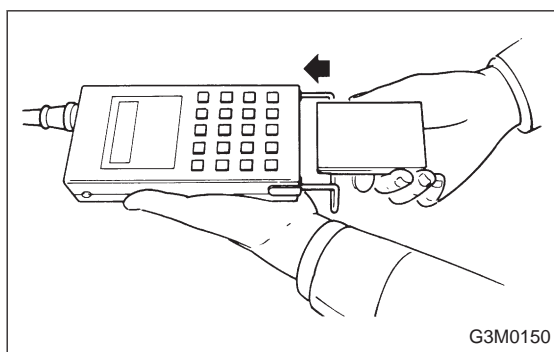

2) Turn ignition switch and Subaru select monitor switch to OFF.

3) Insert cartridge into Subaru select monitor.

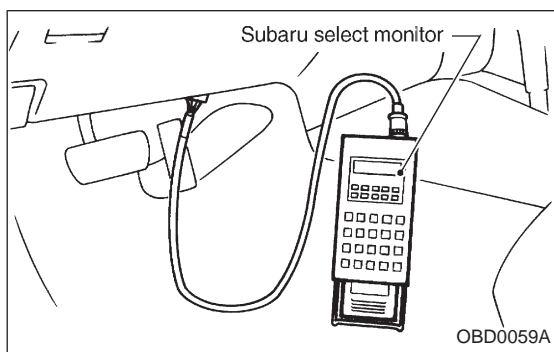

4) Connect Subaru select monitor to data link connector.

- Using data link connector for Subaru select monitor only, connect Subaru select monitor to its data link connector located in the lower portion of the instrument panel (on the driver's side), to the side of the center console box.

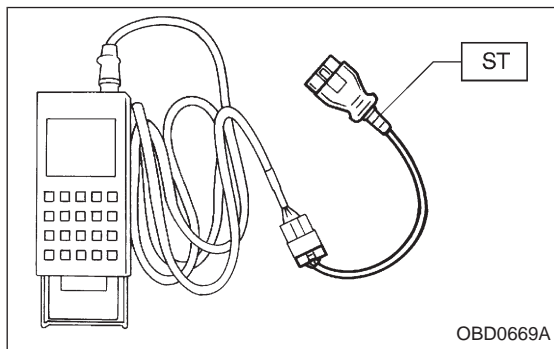

- Using data link connector for Subaru select monitor and OBD-II general scan tool;

(1) Connect ST to Subaru select monitor cable.

ST 498357200 ADAPTER CABLE

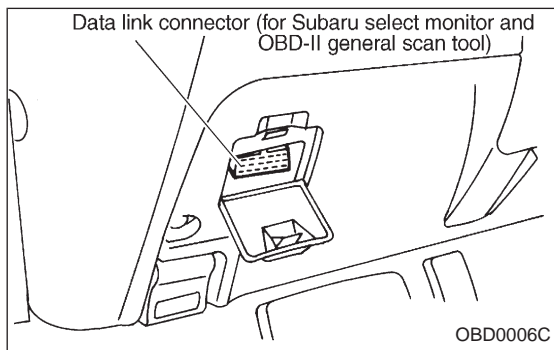

(2) Open the cover and connect Subaru select monitor to data link connector located in the lower portion of the instrument panel (on the driver's side), to the lower cover.

CAUTION:

Do not connect scan tools except for Subaru select monitor and OBD-II general scan tool.

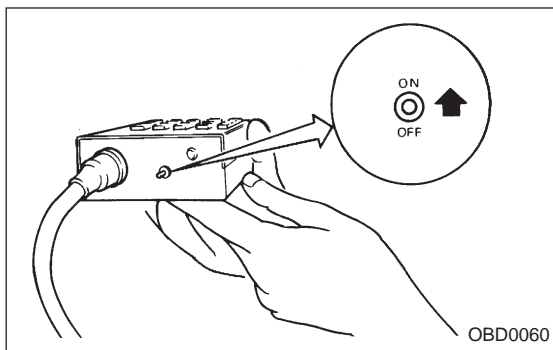

- 5) Turn ignition switch to ON (engine OFF) and Subaru select monitor switch to ON.
- 6) Using Subaru select monitor, call up diagnostic trouble code(s) and various data, then record them.

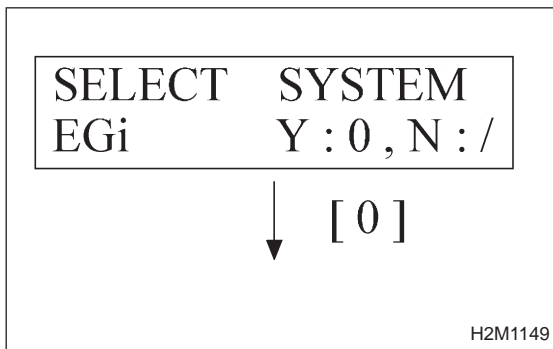

2. READ DIAGNOSTIC TROUBLE CODE (DTC) SHOWN ON DISPLAY. (MODE FB1)

- 1) Select engine mode using function key. Press the function key [0].

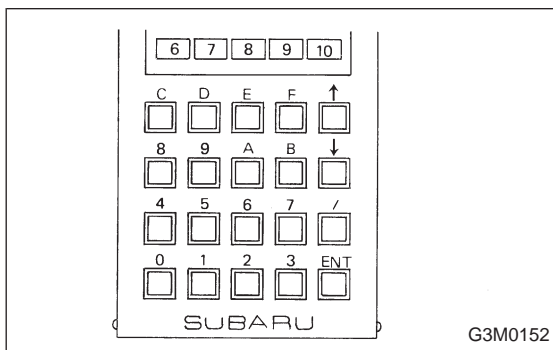

- 2) Designate mode using function key. Press [F] [B] [1] [ENT] in that order.

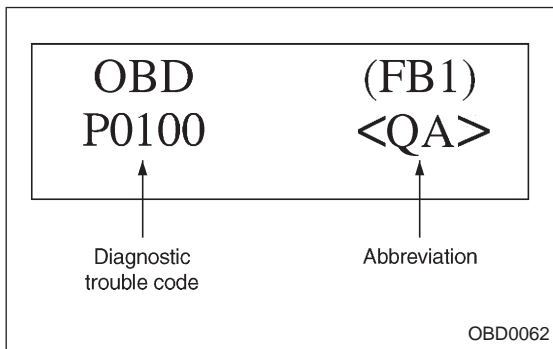

- 3) Ensure diagnostic trouble code(s) is shown.
 - (1) When there is only one diagnostic trouble code.

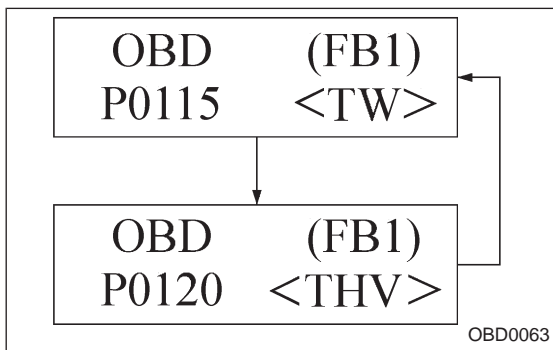

- (2) When there are multiple diagnostic trouble codes.

NOTE:
For details concerning diagnostic trouble codes, refer to the DIAGNOSTIC TROUBLE CODE (DTC) LIST, 2-7 [T10A0].

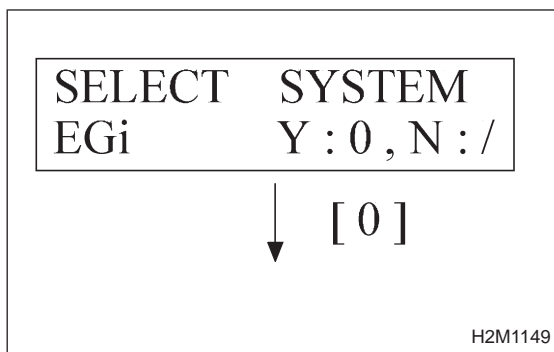

3. READ CURRENT DATA SHOWN ON DISPLAY FOR ENGINE. (FUNCTION MODE)

1) Select engine mode using function key.
Press the function key [0].

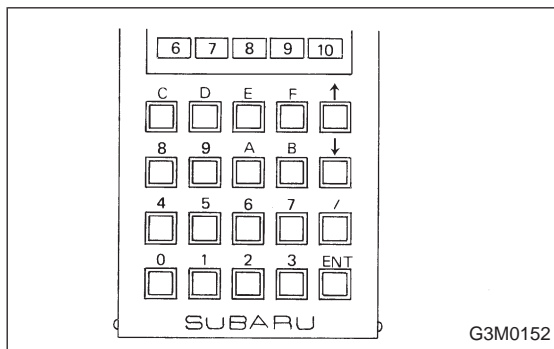

2) Designate mode using function key.
Refer to "6. READ DATA FUNCTION KEY LIST FOR ENGINE" 2-7 [T3C6].

(Example: Press [F] [0] [1] [ENT] in that order.)
3) Ensure data of input or output signal is shown.

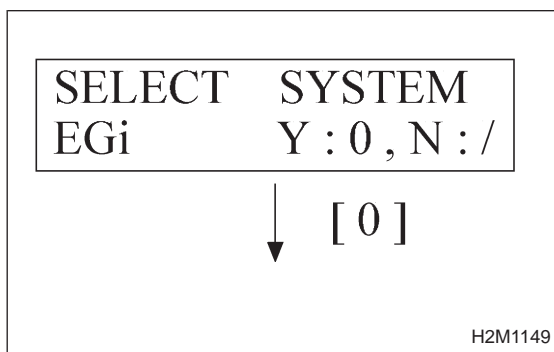

4. READ FREEZE FRAME DATA SHOWN ON DISPLAY. (MODE FB2)

1) Select engine mode using function key.
Press the function key [0].

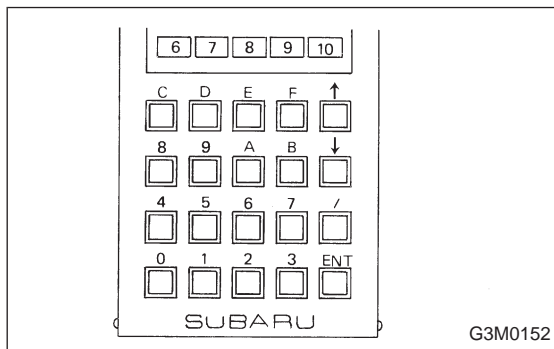

2) Designate mode using function key.
Press [F] [B] [2] [ENT] in that order.

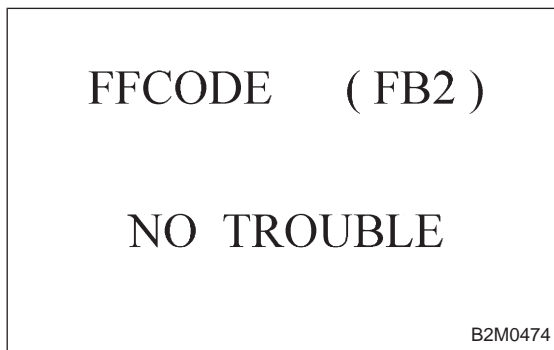

3) Ensure freeze frame data(s) is (are) shown.
(1) When no trouble is detected, or after memory is cleared.

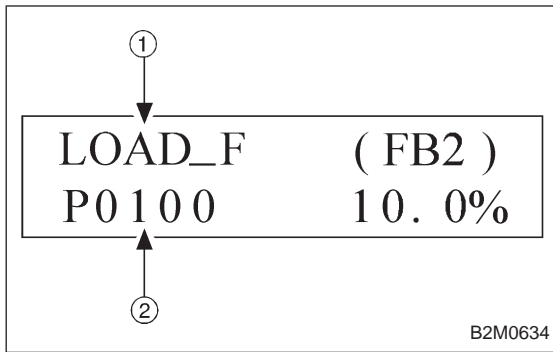

(2) When some trouble is detected.

- ① Abbreviation
- ② Diagnostic trouble code of trouble occurred

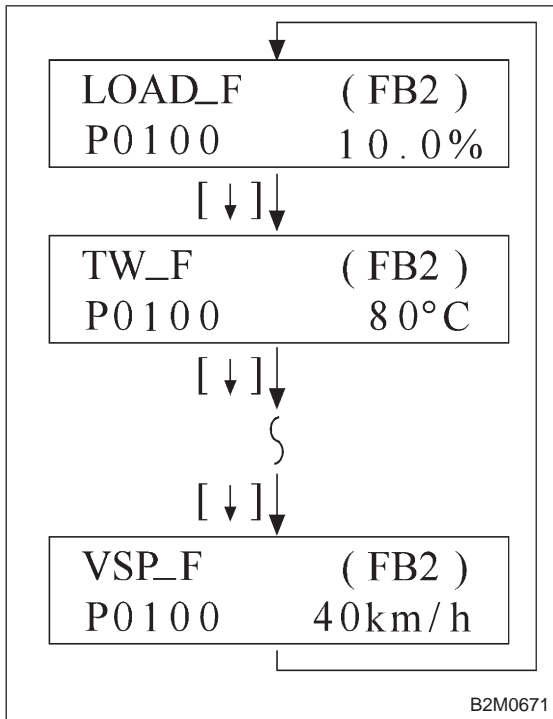

NOTE:

Other freeze frame data is shown on display by pushing the function key [↓].

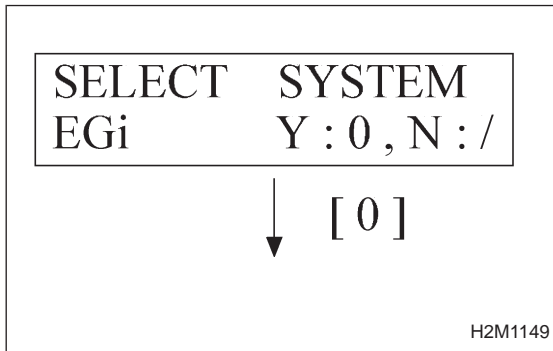

5. READ FREEZE FRAME DATA SHOWN ON DISPLAY. (MODE FB3)

NOTE:

- For items and contents shown on display, refer to “6. READ DATA FUNCTION KEY LIST FOR ENGINE” 2-7 [T3C6].
 - Freeze frame data will not erase without clearing memory.
- 1) Select engine mode using function key. Press the function key [0].

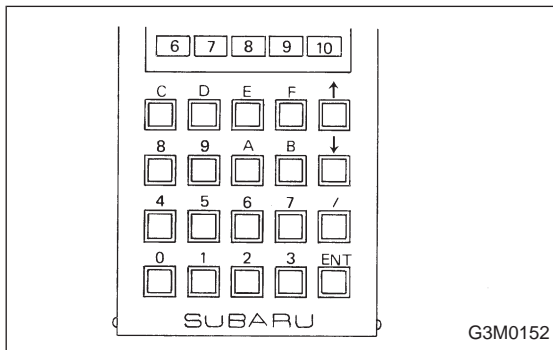

- 2) Designate mode using function key. Press [F] [B] [3] [ENT] in that order.

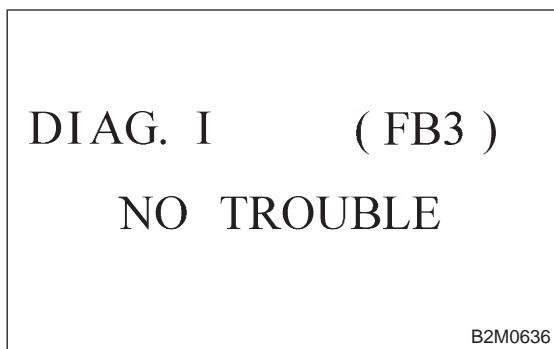

- 3) Ensure freeze frame data(s) is (are) shown.
 (1) When no trouble is detected, or after memory is cleared.

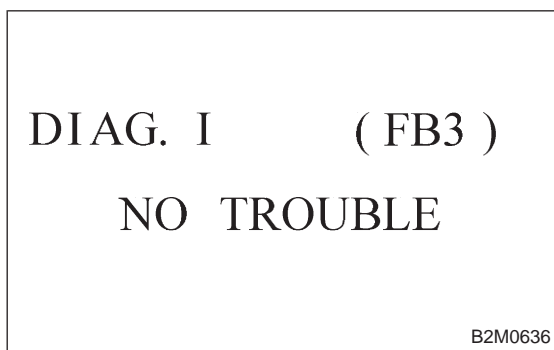

- (2) When a trouble occurs but the corresponding item is not displayed.

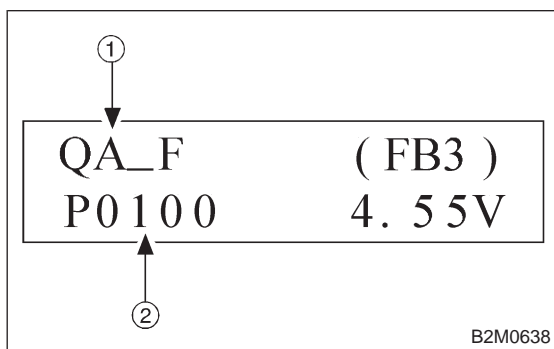

- (3) When only one trouble corresponding to the displayed item has occurred.

- ① Abbreviation
- ② Diagnostic trouble code of trouble occurred

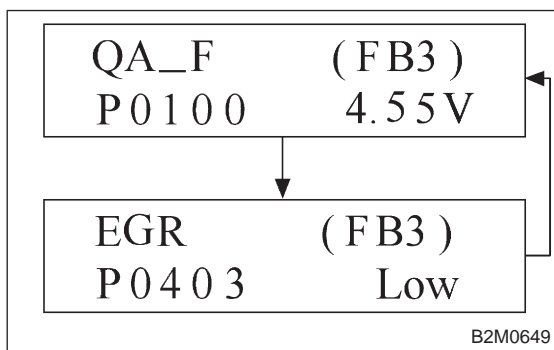

- (4) When multiple troubles corresponding to the displayed item are detected.

NOTE:
 Freeze frame data is shown on display for 2 seconds at a time.

6. READ DATA FUNCTION KEY LIST FOR ENGINE

Function mode	Contents	Abbreviation	Unit of measure
F00	ROM ID number	YEAR	—
F01	Battery voltage	VB	V
F02	Vehicle speed signal	VSP	km/h, MPH
F03	Engine speed signal	EREV	rpm
F04	Engine coolant temperature signal	TW	°C, °F
F05	Ignition signal	ADVS	deg
F06	Mass air flow signal	QA	g/s, V
F07	Throttle position signal	THV	%, V
F08	Injector pulse width	TIM	mS
F09	Idle air control signal	ISC	%
F10	Load data	LOAD	%
F11	Front oxygen sensor output signal	O2	V
F12	Front oxygen sensor maximum and minimum output signal	O2max - min	V, V
F13	Rear oxygen sensor output signal	RO2	V
F14	Rear oxygen sensor maximum and minimum output signal	RO2max - min	V, V
F17	Short term fuel trim	ALPHA	%
F19	Knock sensor signal	KNOCK	deg
F20	Atmospheric absolute pressure signal	BARO. P	kPa, mmHg
F21	Intake manifold absolute pressure signal	MANI. P	kPa, mmHg
F29	A/F correction (short term trim) by rear oxygen sensor	PHOS	%
F30	Long term fuel trim	KBLRC	%
F31	Long term whole fuel trim	K0	%
F32	Front oxygen sensor heater current	FO2H	A
F33	Rear oxygen sensor heater current	RO2H	A
F35	Purge control solenoid valve duty ratio	CPCD	%
F36	Maximum value of cylinder #1 misfire times during 100 rotations	MF1	%
F37	Maximum value of cylinder #2 misfire times during 100 rotations	MF2	%
F38	Maximum value of cylinder #3 misfire times during 100 rotations	MF3	%
F39	Maximum value of cylinder #4 misfire times during 100 rotations	MF4	%
F42	Maximum and minimum EGR system pressure value (AT vehicles only)	EGRmax - min	kPa
F43	Fuel tank pressure signal	TNKP	kPa, mmHg
F44	Fuel temperature signal	TNKT	°C, °F
F45	Fuel level signal	FLEVEL	V
FA0	ON ↔ OFF signal	—	—
FA1	ON ↔ OFF signal	—	—
FA2	ON ↔ OFF signal	—	—
FA3	ON ↔ OFF signal	—	—
FA4	ON ↔ OFF signal	—	—
FA5	ON ↔ OFF signal	—	—
FB0	Diagnostic trouble code (DTC)	INSPECT	—
FB1	Diagnostic trouble code (DTC)	OBD	—

Function mode	Contents	Abbreviation	Unit of measure
FB2	Load data (Freeze frame data)	LOAD-F	%
	Engine coolant temperature signal (Freeze frame data)	TW-F	°C
	Throttle position signal (Freeze frame data)	ALPH-F	%
	Long term fuel trim (Freeze frame data)	KBLR-F	%
	Intake manifold absolute pressure signal (Freeze frame data)	MANI-F	kPa
	Engine speed signal (Freeze frame data)	EREV-F	rpm
	Vehicle speed signal (Freeze frame data)	VSP-F	km/h
FB3	Mass air flow signal (Freeze frame data)	QA-F (P0100)	V
	Pressure signal (Freeze frame data)	PS-F (P0105)	V
	Pressure signal (Freeze frame data)	PR-F (P0106)	V
	Engine coolant temperature signal (Freeze frame data)	TW-F (P0115)	V
	Throttle position signal (Freeze frame data)	THV-F (P0120)	V
	EGR control solenoid valve signal (Freeze frame data)	EGR (P0403)	—*1
	Purge control solenoid valve signal (Freeze frame data)	CPC (P0443)	—*1
	Start switch signal (Freeze frame data)	STSW (P1100)	—*1
	Pressure sources switching solenoid valve signal (Freeze frame data)	BR1 (P1102)	—*1
	Radiator fan relay 1 signal (Freeze frame data)	FAN1 (P1500)	—*1
FC0	Clear memory	—	—
FD01	Compulsory fuel pump relay operation check	FUEL PUMP	—
FD02	Compulsory purge control solenoid valve operation check	CPC SOL	—
FD03	Compulsory radiator fan relay operation check	RAD FAN	—
FD04	Compulsory A/C relay operation check	A/C RELAY	—
FD05	Compulsory EGR control solenoid valve operation check	EGR SOL	—
FD07	Compulsory pressure control solenoid valve operation check	PCV SOL	—
FD08	Compulsory vent control solenoid valve operation check	VENT SOL	—
FD10	Compulsory pressure sources switching solenoid valve operation check	BR SOL	—

NOTE:

1) Subaru select monitor is also available for monitoring information other than that used for check and repair of the vehicle.

2) F42 (Maximum and minimum EGR system pressure value) will not read accurately until the EGR flow diagnosis terminates.

EGR flow diagnosis terminates when LED No. 2 illuminates at function mode FA4.

3) *1: "Hi" or "Low" is shown instead of measured value.

4) Because ASV solenoid valve, FICD solenoid valve and air injection system diagnosis solenoid valve are not installed, FD06, FD09 and FD11 will be displayed but non-functional.

1996	(F00)
2 . 2	SOHC
B2M0476	

7. FUNCTION MODE: F00
— ROM ID NUMBER (YEAR) —
CONDITION:
 Ignition switch “ON”

SPECIFIED DATA:
 Presentation display

- Probable cause (Item outside “specified data”)

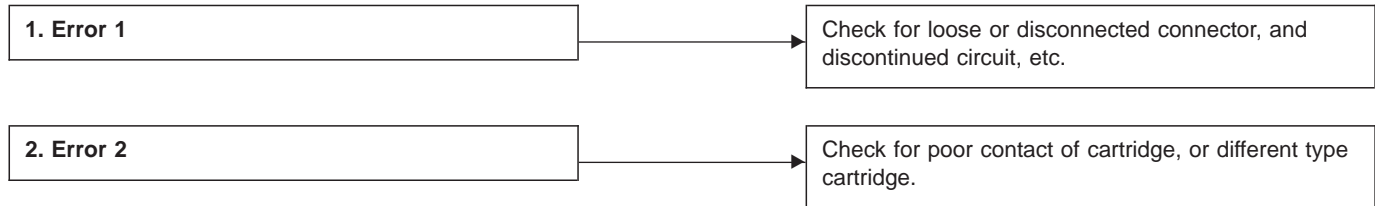

VB	(F01)
12.4 V	
B2M0270	

8. FUNCTION MODE: F01
— BATTERY VOLTAGE (VB) —
CONDITION:
 (1) Ignition switch “ON”
 (2) Idling after warm-up

SPECIFIED DATA:
 (1) 11±1 V
 (2) 13±1 V

- Probable cause (Item outside “specified data”)

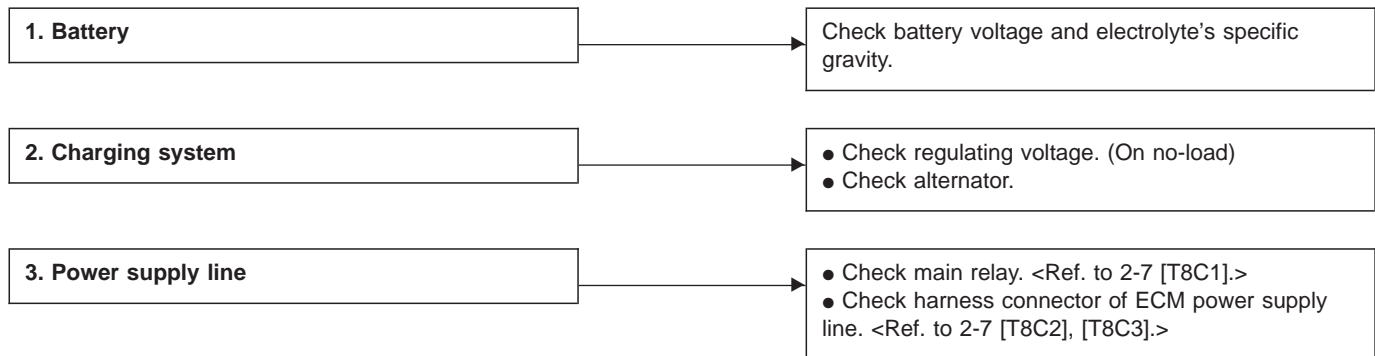

VSP	(F02)
24km/h	15MPH
B2M0754	

9. FUNCTION MODE: F02**— VEHICLE SPEED SIGNAL (VSP) —**

- Vehicle speed is indicated in kilometer per hour (km/h) and mile per hour (MPH) at the same time.

EREV	(F03)
1500 rpm	
B2M0478	

10. FUNCTION MODE: F03**— ENGINE SPEED SIGNAL (EREV) —**

TW	(F04)
80 ° C	176 ° F
B2M0479	

11. FUNCTION MODE: F04**— ENGINE COOLANT TEMPERATURE SIGNAL (TW)**

—

- Engine coolant temperature is indicated in “°C” and “°F” at the same time.

ADVS	(F05)
15 deg	
B2M0480	

12. FUNCTION MODE: F05**— IGNITION SIGNAL (ADVS) —**

NOTE:

The ignition timing value displayed in mode F05 is a value computed by ECM and will not always correspond with the value measured with a timing light.

QA	(F06)
1 . 67g / s	2 . 02V
B2M0481	

13. FUNCTION MODE: F06**— MASS AIR FLOW SIGNAL (QA) —**

- Mass air flow and voltage input from mass air flow sensor are shown on display at the same time.

THV (F07)

0% 0.21V

B2M0482

14. FUNCTION MODE: F07

— THROTTLE POSITION SIGNAL (THV) —

- Throttle position is indicated in percentage (%) and voltage (V) at the same time.

NOTE:

Be sure that the displayed value changes smoothly when changing throttle valve from fully closed to fully opened.

TIM (F08)

2.82 mS

B2M0483

15. FUNCTION MODE: F08

— INJECTOR PULSE WIDTH (TIM) —

ISC (F09)

35.7 %

B2M0484

16. FUNCTION MODE: F09

— IDLE AIR CONTROL SIGNAL (ISC) —

LOAD (F10)

10.0 %

B2M0485

17. FUNCTION MODE: F10

— LOAD DATA (LOAD) —

O2 (F11)

0.60 V

B2M0486

18. FUNCTION MODE: F11

— FRONT OXYGEN SENSOR OUTPUT SIGNAL (O2) —

—

O₂max - min (F12)

0 . 80V 0 . 10V

B2M0487

19. FUNCTION MODE: F12

— FRONT OXYGEN SENSOR MAXIMUM AND MINIMUM OUTPUT SIGNAL (FO₂MAX - MIN) —

- Front oxygen sensor maximum and minimum output signals are indicated at the same time.

RO₂ (F13)

0 . 60 V

B2M0488

20. FUNCTION MODE: F13

— REAR OXYGEN SENSOR OUTPUT SIGNAL (RO₂) —

—

RO₂max - min (F14)

0 . 80V 0 . 10V

B2M0489

21. FUNCTION MODE: F14

— REAR OXYGEN SENSOR MAXIMUM AND MINIMUM OUTPUT SIGNAL (RO₂MAX - MIN) —

- Rear oxygen sensor maximum and minimum output signals are indicated at the same time.

ALPHA (F17)

- 0 . 8 %

B2M0490

22. FUNCTION MODE: F17

— SHORT TERM FUEL TRIM [A/F CORRECTION COEFFICIENT] (ALPHA) —

KNOCK (F19)

3 . 0 deg

B2M0491

23. FUNCTION MODE: F19

— KNOCK SENSOR SIGNAL [IGNITION TIMING CORRECTION COEFFICIENT] (KNOCK) —

BARO. P (F 2 0)

1 0 0 kPa 752 mmHg

B2M0755

24. FUNCTION MODE: F20
— ATMOSPHERIC ABSOLUTE PRESSURE SIGNAL (BARO. P) —

- Atmospheric absolute pressure is indicated in “kPa” and “mmHg” at the same time.

MANI. P (F 2 1)

2 9 kPa 218 mmHg

B2M0756

25. FUNCTION MODE: F21
— INTAKE MANIFOLD ABSOLUTE PRESSURE SIGNAL (MANI. P) —

- Intake manifold absolute pressure is indicated in “kPa” and “mmHg” at the same time.

PHOS (F29)

0 . 7 8 %

B2M0494

26. FUNCTION MODE: F29
— A/F CORRECTION COEFFICIENT [SHORT TERM TRIM] BY REAR OXYGEN SENSOR (PHOS) —

KBLRC (F30)

5 . 5 %

B2M0495

27. FUNCTION MODE: F30
— LONG TERM FUEL TRIM [A/F LEARNING CORRECTION COEFFICIENT] (KBLRC) —

K0 (F31)

0 . 0 %

B2M0496

28. FUNCTION MODE: F31
— LONG TERM FUEL TRIM WHOLE [A/F LEARNING CONTROL COEFFICIENT] (K0) —

FO2H (F32)

1.00 A

B2M0497

29. FUNCTION MODE: F32
 — FRONT OXYGEN SENSOR HEATER CURRENT
 (FO2H) —

RO2H (F33)

1.00 A

B2M0498

30. FUNCTION MODE: F33
 — REAR OXYGEN SENSOR HEATER CURRENT
 (RO2H) —

CPCD (F35)

0%

H2M1325

31. FUNCTION MODE: F35
 — PURGE CONTROL SOLENOID VALVE DUTY RATIO
 (CPCD) —

MF1 (F36)

0 %

B2M0499

32. FUNCTION MODE: F36
 — MAXIMUM VALUE OF CYLINDER #1 MISFIRE RATE
 DURING 100 ROTATIONS (MF1) —

MF2 (F37)

0 %

B2M0500

33. FUNCTION MODE: F37
 — MAXIMUM VALUE OF CYLINDER #2 MISFIRE RATE
 DURING 100 ROTATIONS (MF2) —

MF3	(F38)
0 %	
B2M0501	

34. FUNCTION MODE: F38
 — MAXIMUM VALUE OF CYLINDER #3 MISFIRE RATE DURING 100 ROTATIONS (MF3) —

MF4	(F39)
0 %	
B2M0502	

35. FUNCTION MODE: F39
 — MAXIMUM VALUE OF CYLINDER #4 MISFIRE RATE DURING 100 ROTATIONS (MF4) —

EGRmax-min	(F42)
100kPa	4kPa
B2M0759	

36. FUNCTION MODE: F42
 — MAXIMUM AND MINIMUM EGR SYSTEM PRESSURE VALUE [AT VEHICLES] (EGRMAX-MIN) —
 ● Maximum and minimum EGR system pressure value are indicated at the same time.

TNKP	(F43)
0.10kPa	1mmHg
H2M1326	

37. FUNCTION MODE: F43
 — FUEL TANK PRESSURE SIGNAL (TNKP) —

TNKT	(F44)
20°C	68°F
H2M1308	

38. FUNCTION MODE: F44
 — FUEL TEMPERATURE SIGNAL (TNKT) —

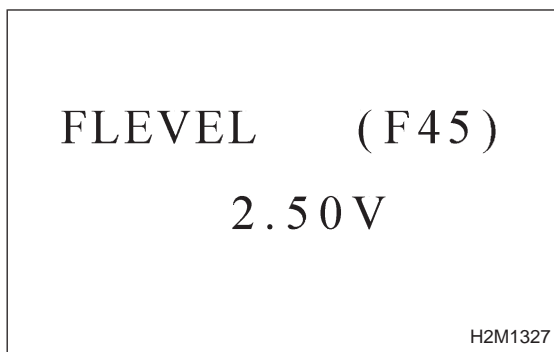

39. FUNCTION MODE: F45 — FUEL LEVEL SIGNAL (FLEVEL) —

40. FA MODE FOR ENGINE

Function mode	LED No.	Contents	Display	LED "ON" requirements
FA0	3	Neutral switch	NT	When neutral position signal is entered.
	7	Test mode connector	UD	When test mode connector is connected.
	8	AT/MT identification signal	AT	When AT identification signal is entered.
	9	Ignition switch	IG	When ignition switch is turned ON.
FA1	1	Radiator fan relay 2	R2	When radiator fan relay 2 is in function.
	2	Knock signal	KS	When knock signal is entered.
	3	Purge control solenoid valve	CN	When purge control solenoid valve is in function.
	4	Fuel pump relay	FP	When fuel pump relay is in function.
	6	Radiator fan relay 1	R1	When radiator fan relay 1 is in function.
	7	Air conditioner relay	AR	When air conditioner relay is in function.
	8	Air conditioner switch	AC	When air conditioner switch is turned ON.
FA2	2	AEC signal	EC	When AEC signal is entered.
	3	EAM signal	AM	When EAM signal is gone out.
	4	AEB signal	EB	When AEB signal is entered.
	6	AET signal	ET	When AET signal is entered.
	7	Engine torque control signal	TR	When engine torque control signal is entered.
FA3	7	Pressure sources switching solenoid valve	BR	When pressure sources switching solenoid valve is in function.
FA4	1	Catalyst	CA	When diagnosis of catalyzer is finished.
	2	EGR system	E1	When diagnosis of EGR system is finished.
	3	California model identification signal	FC	When California model identification signal is entered.
	8	Rear oxygen sensor signal	OR	When rear oxygen sensor mixture ratio is rich.
	9	Front oxygen sensor signal	O2	When front oxygen sensor mixture ratio is rich.
FA5	6	Vent control solenoid valve	AL	When vent control solenoid valve is in function.
	7	EGR solenoid valve	ER	When EGR solenoid valve is in function.
	8	Pressure control solenoid valve	PC	When pressure control solenoid valve is in function.

LED No.	Signal name	Display
1	—	—
2	—	—
3	Neutral switch	NT
4	—	—
5	—	—
6	—	—
7	Test mode connector	UD
8	Identification of AT model	AT
9	Ignition switch	IG
0	—	—

—	—	NT	—	—
—	UD	AT	IG	—

1	2	3	4	5
6	7	8	9	0

41. FUNCTION MODE: FA0

— ON ↔ OFF SIGNAL —

Requirement for LED “ON”.

- LED No. 3 ● On MT model, gear position is in neutral.
● On AT model, shift position is in “P” or “N”.
- LED No. 7 Test mode connector is connected.
- LED No. 8 Vehicle is AT model.
- LED No. 9 Ignition switch is turned ON.

LED No.	Signal name	Display
1	Radiator fan relay 2	R2
2	Knock signal	KS
3	Purge control solenoid valve	CN
4	Fuel pump relay	FP
5	—	—
6	Radiator fan relay 1	R1
7	A/C relay	AR
8	A/C switch	AC
9	—	—
0	—	—

R2	KS	CN	FP	—
R1	AR	AC	—	—

1	2	3	4	5
6	7	8	9	0

42. FUNCTION MODE: FA1

— ON ↔ OFF SIGNAL —

Requirement for LED “ON”.

- LED No. 1 Radiator fan relay 2 is turned ON.
- LED No. 2 Engine is knocking.
- LED No. 3 Purge control solenoid valve is in function.
- LED No. 4 Fuel pump relay is turned ON.
- LED No. 6 Radiator fan relay 1 is turned ON.
- LED No. 7 A/C relay is turned ON.
- LED No. 8 A/C switch is turned ON.

NOTE:

- When LED No. 1, 3, 4, 6 and 7 blinks with the test mode connector connected and the ignition switch turned to ON, the corresponding part is functioning properly.
- When LED No. 4 illuminates for only 2 seconds after the ignition switch is turned to ON, (and then goes out), the corresponding part is functioning properly.

LED No.	Signal name	Display
1	—	—
2	AEC signal	EC
3	EAM signal	AM
4	AEB signal	EB
5	—	—
6	AET signal	ET
7	Engine torque control signal	TR
8	—	—
9	—	—
0	—	—

—	EC	AM	EB	—
ET	TR	—	—	—

1	2	3	4	5
---	---	---	---	---

6	7	8	9	0
---	---	---	---	---

LED No.	Signal name	Display
1	—	—
2	—	—
3	—	—
4	—	—
5	—	—
6	—	—
7	Pressure sources switching solenoid valve	BR
8	—	—
9	—	—
0	—	—

—	—	—	—	—
—	BR	—	—	—

1	2	3	4	5
---	---	---	---	---

6	7	8	9	0
---	---	---	---	---

43. FUNCTION MODE: FA2

— ON ↔ OFF SIGNAL —

Requirement for LED "ON".

LED No. 2 ECM entered the AEC signal emitted from TCS C/M.

LED No. 3 EAM signal goes out.

LED No. 4 ECM entered the AEB signal emitted from TCS C/M.

LED No. 6 ECM entered the AET signal emitted from TCS C/M.

LED No. 7 ECM entered the torque control signal emitted from TCM.

44. FUNCTION MODE: FA3

— ON ↔ OFF SIGNAL —

Requirement for LED "ON".

LED No. 7 Pressure sources switching solenoid valve is in function.

NOTE:

When LED No. 7 blinks with the test mode connector connected and the ignition switch turned to ON, the corresponding part is functioning properly.

LED No.	Signal name	Display
1	Catalyst	CA
2	EGR system	E1
3	California model identification signal	FC
4	—	—
5	—	—
6	—	—
7	—	—
8	Rear oxygen sensor signal	OR
9	Front oxygen sensor signal	O2
0	—	—

CA	E1	FC	—	—
—	—	OR	O2	—

1	2	3	4	5
6	7	8	9	0

45. FUNCTION MODE: FA4

— ON ↔ OFF SIGNAL —

Requirement for LED "ON".

- LED No. 1 Diagnosis of catalyzer is finished.
- LED No. 2 Diagnosis of EGR system is finished.
- LED No. 3 Vehicle is except California model.
- LED No. 8 Rear oxygen sensor mixture ratio is rich.
- LED No. 9 Front oxygen sensor mixture ratio is rich.

LED No.	Signal name	Display
1	—	—
2	—	—
3	—	—
4	—	—
5	—	—
6	Vent control solenoid valve	AL
7	EGR solenoid valve	ER
8	Pressure control solenoid valve	PC
9	—	—
0	—	—

—	—	—	—	—
AL	ER	PC	—	—

1	2	3	4	5
6	7	8	9	0

46. FUNCTION MODE: FA5

— ON ↔ OFF SIGNAL —

Requirement for LED "ON".

- LED No. 6 Vent control solenoid valve is in function.
- LED No. 7 EGR solenoid valve is in function.
- LED No. 8 Pressure control solenoid valve is in function.

NOTE:

When LED No. 6, 7 and 8 blinks with the test mode connector connected and the ignition switch turned to ON, the corresponding part is functioning properly.

47. FB MODE FOR ENGINE

Function mode	Abbreviation	Contents	Contents of display	Page
FB0	INSPECT	On-board diagnostics (Inspection)	Current trouble code indicated by on-board diagnostics after clear memory.	58 <Ref. to 2-7 [T3E1].>
FB1	OBD	On-board diagnostics (Read data)	Current trouble code indicated by on-board diagnostics.	32 <Ref. to 2-7 [T3C1].>
FB2	LOAD-F	Load data	<ul style="list-style-type: none"> ● Freeze frame data ● Data stored at the time of trouble occurrence, is shown on display. 	34 <Ref. to 2-7 [T3C4].>
	TW-F	Engine coolant temperature signal		
	ALPH-F	Throttle position signal		
	KBLR-F	Long term fuel trim		
	MANI-F	Intake manifold absolute pressure signal		
	EREV-F	Engine speed signal		
	VSP-F	Vehicle speed signal		
FB3	QA-F (P0100)	Mass air flow signal	<ul style="list-style-type: none"> ● Freeze frame data ● Data stored at the time of trouble occurrence, is shown on display. 	35 <Ref. to 2-7 [T3C5].>
	PS-F (P0105)	Pressure signal		
	PR-F (P0106)	Pressure signal		
	TW-F (P0115)	Engine coolant temperature signal		
	THV-F (P0120)	Throttle position signal		
	EGR (P0403)	EGR control solenoid valve signal		
	CPC (P0443)	Purge control solenoid valve signal		
	STSW (P1100)	Start switch signal		
	BR1 (P1102)	Pressure sources switching solenoid valve signal		
	FAN1 (P1500)	Radiator fan relay 1 signal		

48. FC MODE FOR ENGINE

Function mode	Abbreviation	Contents	Contents of display	Page
FC0	MEMORY CLR	Back-up memory clear	Function of clearing trouble code stored in memory.	57 <Ref. to 2-7 [T3D1].>

49. FD MODE FOR ENGINE

Function mode	Abbreviation	Contents	Contents of display	Page
FD01	FUEL PUMP	Compulsory valve operation check	Function of checking operation of fuel pump relay, purge control solenoid valve, radiator fan relay, A/C relay, EGR control solenoid valve, pressure control solenoid valve, vent control solenoid valve and pressure sources switching solenoid valve.	63 <Ref. to 2-7 [T3F1].>
FD02	CPC SOL			
FD03	RAD FAN			
FD04	A/C RELAY			
FD05	EGR SOL			
FD07	PCV SOL			
FD08	VENT SOL			
FD10	BR SOL			

NOTE:

Because ASV solenoid valve, FICD solenoid valve and air injection system diagnosis solenoid valve are not installed, FD06, FD09 and FD11 will be displayed but non-functional.

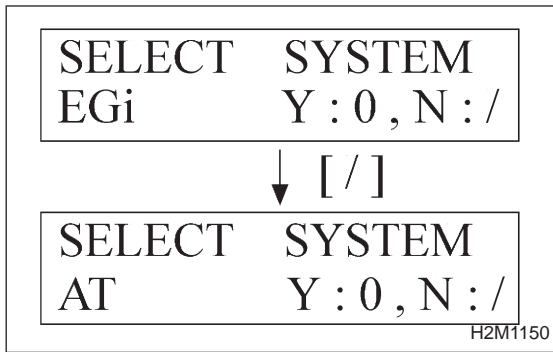

50. READ CURRENT DATA SHOWN ON DISPLAY FOR AT. (FUNCTION MODE)

1) Select AT mode using function key.
Press the function key [/], and change to AT mode.

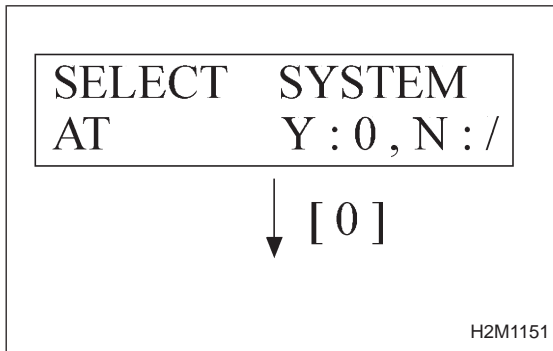

2) Press the function key [0].

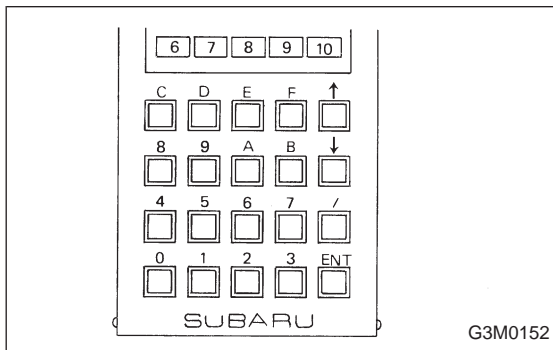

3) Designate mode using function key.

Refer to “51. READ DATA FUNCTION KEY LIST FOR AT” 2-7 [T3C51].

(Example: Press [F] [0] [2] [ENT] in that order.)

4) Ensure data of input or output signal is shown.

51. READ DATA FUNCTION KEY LIST FOR AT

Function mode	Contents	Abbr.	Unit
F00	Mode display	—	—
F01	Battery voltage	VB	V
F02	Vehicle speed sensor 1	VSP1	m/h
F03	Vehicle speed sensor 1	VSP1	km/h
F04	Vehicle speed sensor 2	VSP2	m/h
F05	Vehicle speed sensor 2	VSP2	km/h
F06	Engine speed	EREV	rpm
F07	ATF temperature sensor	ATFT	deg F
F08	ATF temperature sensor	ATFT	deg C
F09	Throttle position sensor	THV	V
F10	Gear position	GEAR	—
F11	Line pressure duty	PLDTY	%
F12	Lock-up duty	LUPTY	%
F13	AWD duty	4WDTY	%
F14	Throttle position sensor power supply	THVCC	V
F15	Mass air flow sensor	AFM	V

E-4AT	(F00)
4WD	1993
G3M0723	

52. FUNCTION MODE: F00

— MODE DISPLAY —

SPECIFIED DATA:

Data at the left should be indicated.

Probable cause (if outside "specified data")

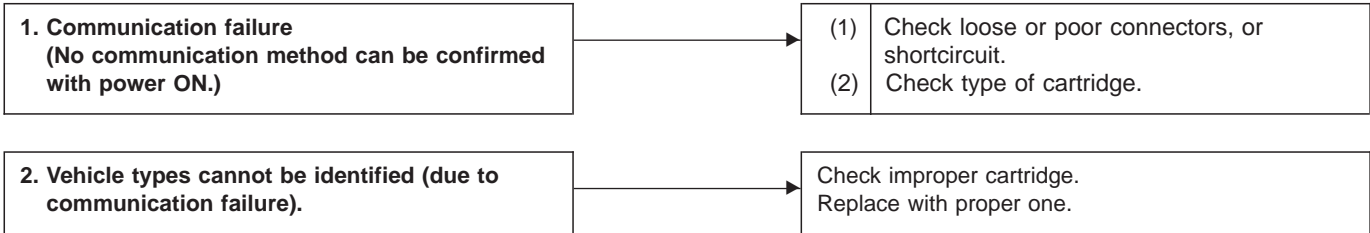

VB	(F01)
12.7 V	
OBD0673	

53. FUNCTION MODE: F01

— BATTERY VOLTAGE (VB) —

CONDITION:

- (1) Ignition switch ON
- (2) Engine idling after warm-up

SPECIFIED DATA:

- (1) 12±1 V
- (2) 13±1 V

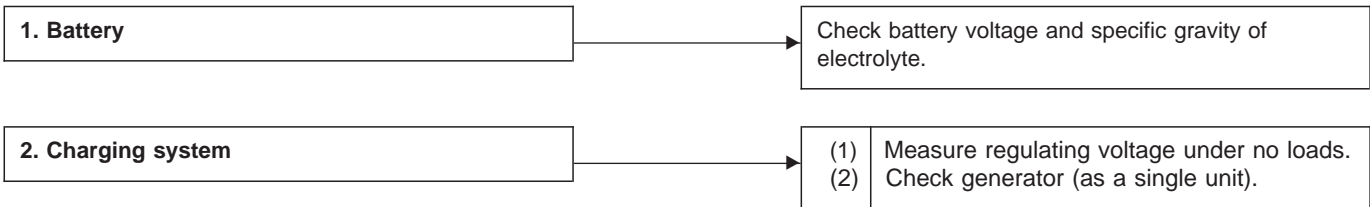

VSP1	(F02)
18 m/h	
G3M0725	

54. FUNCTION MODE: F02**— VEHICLE SPEED SENSOR 1 (VSP1) —**

- F02: Vehicle speed is indicated in mile per hour (m/h).
- F03: Vehicle speed is indicated in kilometer per hour (km/h).

VSP2	(F04)
12 m/h	
G3M0726	

55. FUNCTION MODE: F04**— VEHICLE SPEED SENSOR 2 (VSP2) —**

- F04: Vehicle speed is indicated in mile per hour (m/h).
- F05: Vehicle speed is indicated in kilometer per hour (km/h).

EREV	(F06)
1,500 rpm	
G3M0727	

56. FUNCTION MODE: F06**— ENGINE SPEED (EREV) —**

ATFT	deg F	(F07)
176 deg F		
G3M0728		

57. FUNCTION MODE: F07**— ATF TEMPERATURE SENSOR (ATFT) —**

- F07: ATF temperature is indicated in “deg F”.
- F08: ATF temperature is indicated in “deg C”.

THV	(F09)
4.0 V	
G3M0935	

58. FUNCTION MODE: F09**— THROTTLE POSITION SENSOR (THV) —**

GEAR (F10)
1st
G3M0730

59. FUNCTION MODE: F10
— GEAR POSITION (GEAR) —

PLDTY (F11)
50%
G3M0731

60. FUNCTION MODE: F11
— LINE PRESSURE DUTY (PLDTY) —

LUPTY (F12)
5%
G3M0732

61. FUNCTION MODE: F12
— LOCK-UP DUTY (LUPTY) —

4WDTY (F13)
95%
G3M0733

62. FUNCTION MODE: F13
— AWD DUTY (4WDTY) —

THVCC (F14)
5.2 V
B3M0259

63. FUNCTION MODE: F14
— THROTTLE POSITION SENSOR POWER SUPPLY (THVCC) —

LED No.	Signal name	Display
1	FWD switch	FF
2	Kick-down switch	KD
3	—	—
4	—	—
5	Brake switch	BR
6	ABS switch	AB
7	Cruise control set	CR
8	Power switch	PW
9	—	—
10	—	—

FF	KD	—	—	BR
AB	CR	PW	—	—

1	2	3	4	5
---	---	---	---	---

6	7	8	9	10
---	---	---	---	----

64. FUNCTION MODE: FA0

— ON ↔ OFF SIGNAL —

Requirement for LED "ON".

LED No. 1 Fuse is installed in FWD switch.

LED No. 2 Kick-down switch is turned ON. (Europe and General models only)

LED No. 5 Brake pedal is depressed.

LED No. 6 ABS signal is entered.

LED No. 7 Cruise control is set.

LED No. 8 Power switch is turned ON. (Europe and General models only)

LED No.	Signal name	Display
1	N/P range switch	NP
2	R range switch	RR
3	D range switch	RD
4	3 range switch	R3
5	2 range switch	R2
6	1 range switch	R1
7	Diagnosis switch	SS
8	—	—
9	—	—
10	—	—

NP	RR	RD	R3	R2
R1	SS	—	—	—

1	2	3	4	5
---	---	---	---	---

6	7	8	9	10
---	---	---	---	----

65. FUNCTION MODE: FA1

— ON ↔ OFF SIGNAL —

Requirement for LED "ON".

LED No. 1 "N" or "P" range is selected.

LED No. 2 "R" range is selected.

LED No. 3 "D" range is selected.

LED No. 4 "3" range is selected.

LED No. 5 "2" range is selected.

LED No. 6 "1" range is selected.

LED No. 7 Diagnosis connector is connected.

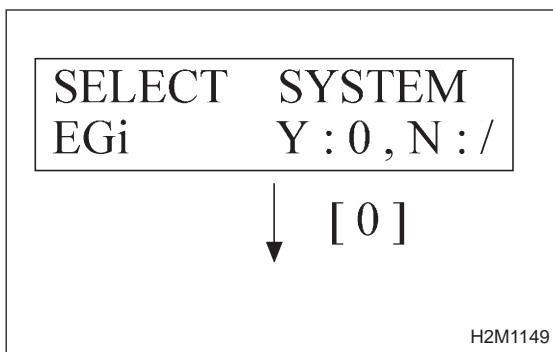

D: CLEAR MEMORY MODE

1. SUBARU SELECT MONITOR

- 1) Select engine mode or AT mode using function key.
 - Engine mode:
Press the function key [0].
 - AT mode:
Press the function key [/] [0] in that order.

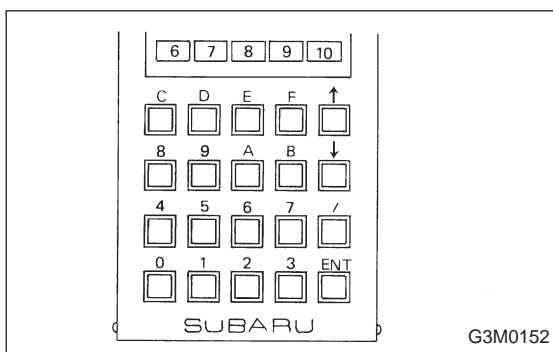

- 2) Designate mode using function key.
Press [F] [C] [0] [ENT] in that order.

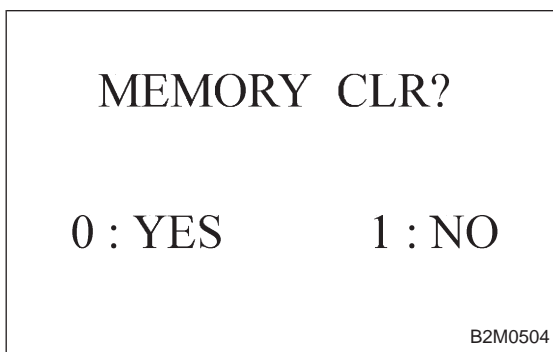

- 3) Ensure displayed message.

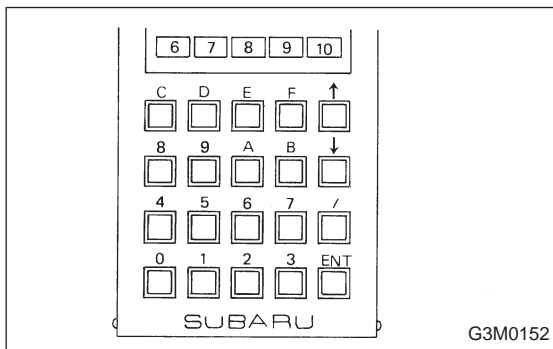

- 4) Press function key.
 - When executing, (YES)
Press [0] [ENT] in that order.
 - When not executing, (NO)
Press [1] [ENT] in that order.

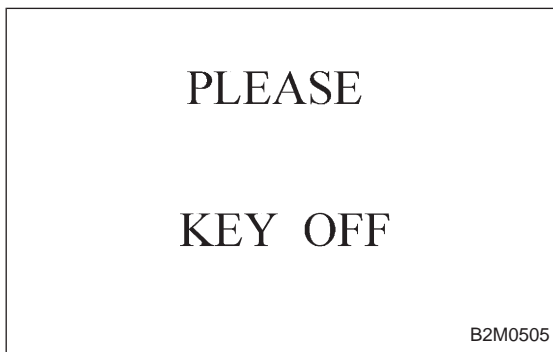

- 5) When executed, the indication as shown here appears for approximately four seconds, and the past trouble history is deleted.

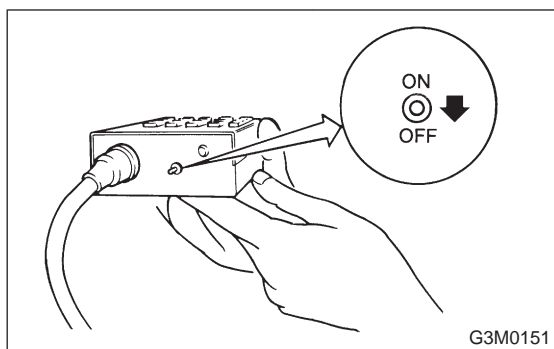

6) After the display is gone, turn Subaru select monitor switch and ignition switch to OFF.

NOTE:

When the ECM, battery terminals, etc. are disconnected after memory is cleared, idling speed may increase. This is not considered a problem because the ISC valve duty controlled learning value has been cleared. To return the engine to idling speed, idle for approximately 2 minutes with air conditioner off.

2. OBD-II GENERAL SCAN TOOL

For clear memory procedures using the OBD-II general scan tool, refer to the OBD-II General Scan Tool Instruction Manual.

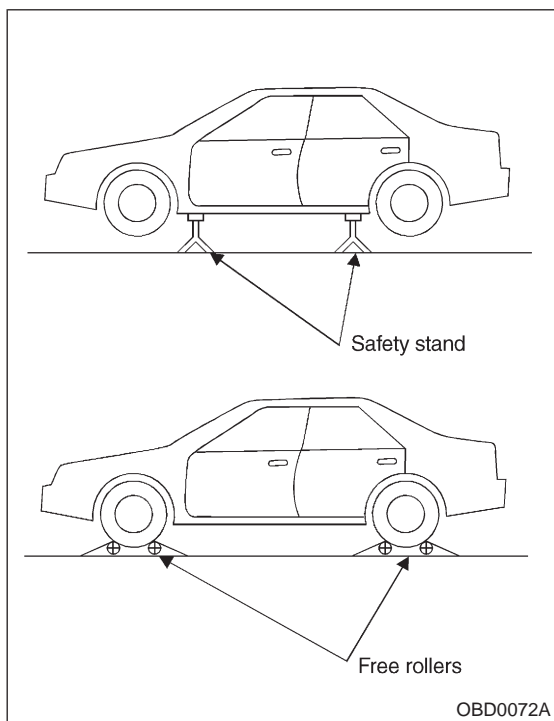

E: INSPECTION MODE

1. PREPARATIONS FOR THE INSPECTION MODE

Raise the vehicle using a garage jack and place on safety stands or drive the vehicle onto free rollers.

● FULL-TIME AWD MODELS

WARNING:

- Before raising the vehicle, ensure parking brakes are applied.
- Do not use a pantograph jack in place of a safety stand.
- Secure a rope or wire to the front and rear towing or tie-down hooks to prevent the lateral runout of front wheels.
- Do not abruptly depress/release clutch pedal or accelerator pedal during works even when engine is operating at low speeds since this may cause vehicle to jump off free rollers.
- In order to prevent the vehicle from slipping due to vibration, do not place any wooden blocks or similar items between the safety stands and the vehicle.

- Since the rear wheels will also rotate, do not place anything near them. Also, make sure that nobody goes in front of the vehicle.

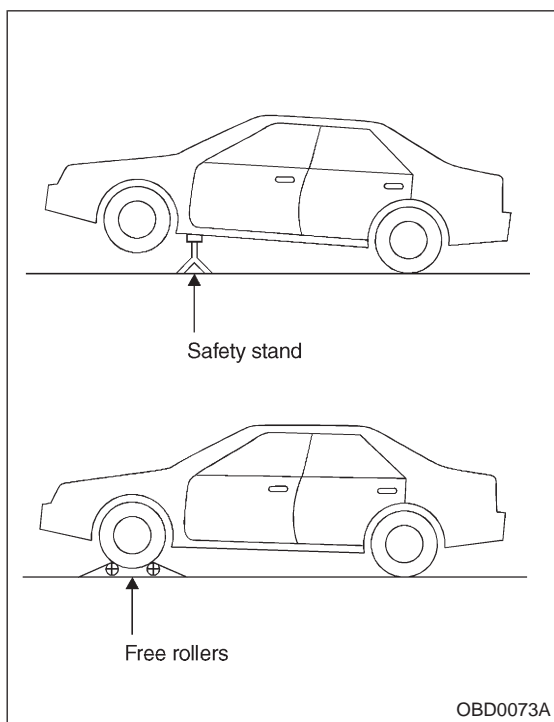

● FWD MODELS

WARNING:

- Before raising the vehicle, ensure parking brakes are applied.
- Do not use a pantograph jack in place of a safety stand.
- If only the front wheels are raised or placed on a free roller, apply parking brakes and lock the rear wheels.
- Secure a rope or wire to the front and rear towing or tie-down hooks to prevent the lateral runout of front wheels.
- Do not abruptly depress/release clutch pedal or accelerator pedal during works even when engine is operating at low speeds since this may cause vehicle to jump off free rollers.
- In order to prevent the vehicle from slipping due to vibration, do not place any wooden blocks or similar items between the safety stands and the vehicle.
- Since the rear wheels will also rotate, do not place anything near them. Also, make sure that nobody goes in front of the vehicle.

2. SUBARU SELECT MONITOR

After performing diagnostics and clearing the memory, check for any remaining unresolved trouble data.

1) Prepare Subaru select monitor and cartridge.

- ST1 498307500 SELECT MONITOR KIT
- ST2 498345700 CARTRIDGE

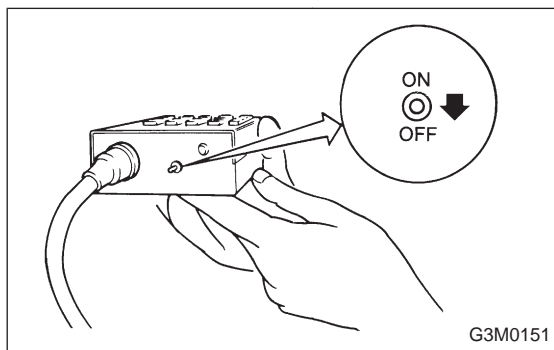
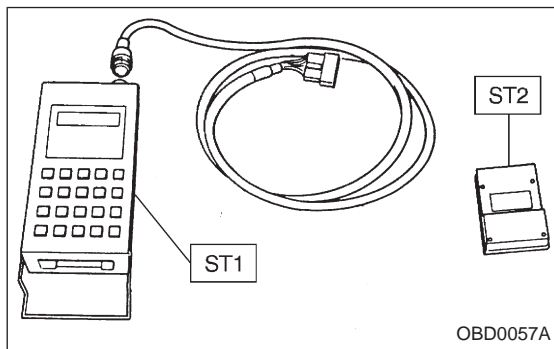

2) Turn ignition switch and Subaru select monitor switch to OFF.

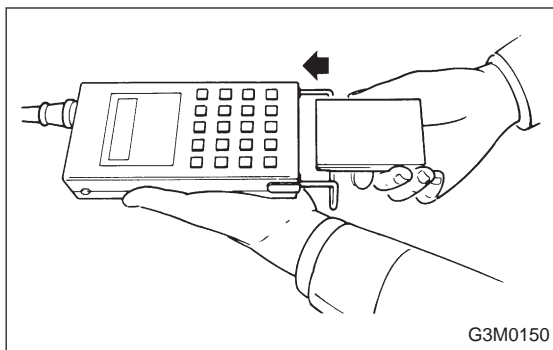

3) Insert cartridge into Subaru select monitor.

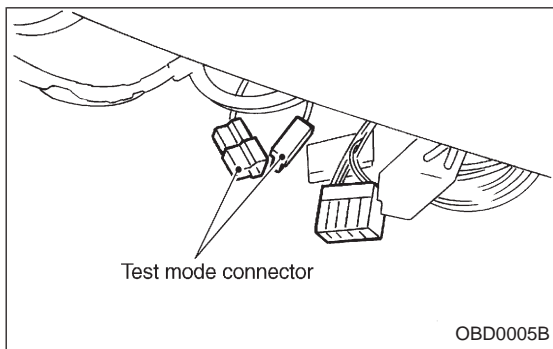

4) Connect test mode connector at the lower portion of instrument panel (on the driver's side), to the side of the center console box.

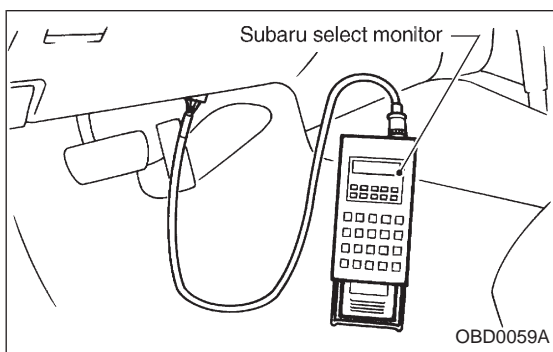

5) Connect Subaru select monitor to data link connector.

- Using data link connector for Subaru select monitor only: Connect Subaru select monitor to its data link connector located in the lower portion of the instrument panel (on the driver's side), to the side of the center console box.

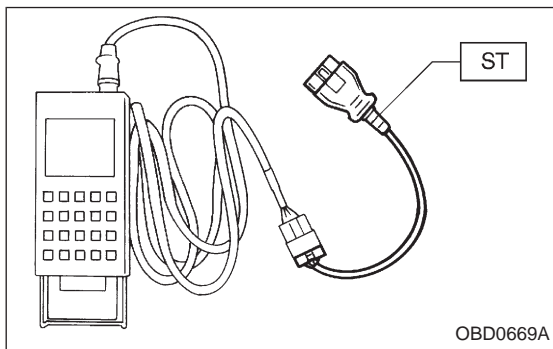

- Using data link connector for Subaru select monitor and OBD-II general scan tool:

(1) Connect ST to Subaru select monitor cable.

ST 498357200 ADAPTER CABLE

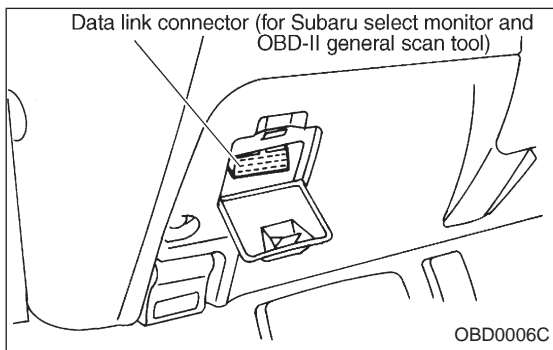

(2) Open the cover and connect Subaru select monitor to data link connector located in the lower portion of the instrument panel (on the driver's side), to the lower cover.

CAUTION:

Do not connect scan tools except for Subaru select monitor and OBD-II general scan tool.

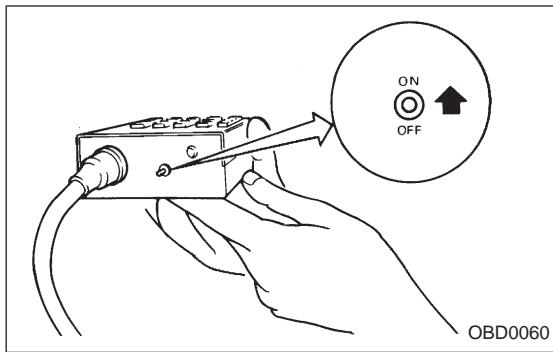

6) Turn ignition switch to ON (engine OFF) and Subaru select monitor switch to ON.

7) Start the engine.

NOTE:

- Ensure the selector lever is placed in the “P” position before starting. (AT vehicles)
- Depress clutch pedal when starting the engine. (MT vehicles)

8) Using the selector lever or shift lever, turn the “P” position switch and the “N” position switch to ON.

9) Depress the brake pedal to turn the brake switch ON. (AT vehicles)

10) Keep engine speed in the 2,500 — 3,000 rpm range for 40 seconds.

NOTE:

On models without tachometer, use the Subaru select monitor or tachometer (Secondary pickup type).

11) Place the selector lever or shift lever in the “D” position (AT vehicles) or “1st” gear (MT vehicles) and drive the vehicle at 5 to 10 km/h (3 to 6 MPH).

NOTE:

- On AWD vehicles, release the parking brake.
- The speed difference between front and rear wheels may light either the ABS or the ABS/TCS warning light, but this indicates no malfunctions. When engine control diagnosis is finished, perform the ABS or the ABS/TCS memory clearance procedure of self-diagnosis system. <Ref. to 4-4b [T6D2] or [T9K0], 4-4c [T6D2] or [T9J0].>

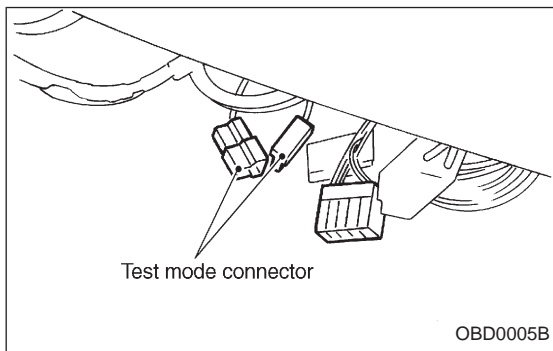

3. OBD-II GENERAL SCAN TOOL

After performing diagnostics and clearing the memory, check for any remaining unresolved trouble data:

1) Connect test mode connector at the lower side of the instrument panel (on the driver’s side), to the side of the center console box.

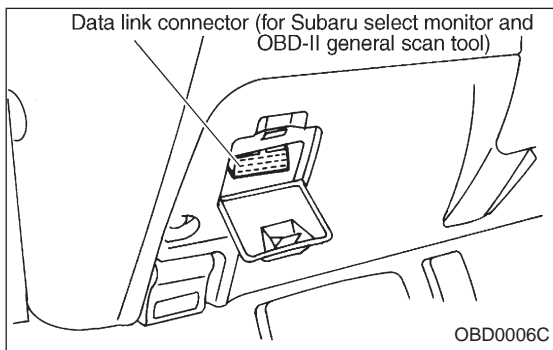

2) Open the cover and connect the OBD-II general scan tool to its data link connector in the lower portion of the instrument panel (on the driver’s side), to the lower cover.

CAUTION:

Do not connect the scan tools except for Subaru select monitor and OBD-II general scan tool.

3) Start the engine.

NOTE:

- Ensure the selector lever is placed in the “P” position before starting. (AT vehicles)
- Depress clutch pedal when starting the engine. (MT vehicles)

4) Using the selector lever or shift lever, turn the “P” position switch and the “N” position switch to ON.

5) Depress the brake pedal to turn the brake switch ON. (AT vehicles)

6) Keep engine speed in the 2,500 — 3,000 rpm range for 40 seconds.

NOTE:

On models without tachometer, use the Subaru select monitor or tachometer (Secondary pickup type).

7) Place the selector lever or shift lever in the “D” position (AT vehicles) or “1st” gear (MT vehicles) and drive the vehicle at 5 to 10 km/h (3 to 6 MPH).

NOTE:

- On AWD vehicles, release the parking brake.
- The speed difference between front and rear wheels may light either the ABS or the ABS/TCS warning light, but this indicates no malfunctions. When engine control diagnosis is finished, perform the ABS or the ABS/TCS memory clearance procedure of self-diagnosis system. <Ref. to 4-4b [T6D2] or [T9K0], 4-4c [T6D2] or [T9J0].>

8) Using the OBD-II general scan tool, check for diagnostic trouble code(s) and record the result(s).

NOTE:

- For detailed operation procedures, refer to the OBD-II General Scan Tool Instruction Manual.
- For details concerning diagnostic trouble codes, refer to the DIAGNOSTIC TROUBLE CODE (DTC) LIST, 2-7 [T10A0].

4. READ DIAGNOSTIC TROUBLE CODE (DTC) SHOWN ON DISPLAY. (MODE FB0 <INSPECTION MODE>)

Using Subaru select monitor, check for diagnostic trouble code(s) and record the result(s).

- 1) Select engine mode using function key. Press the function key [0].

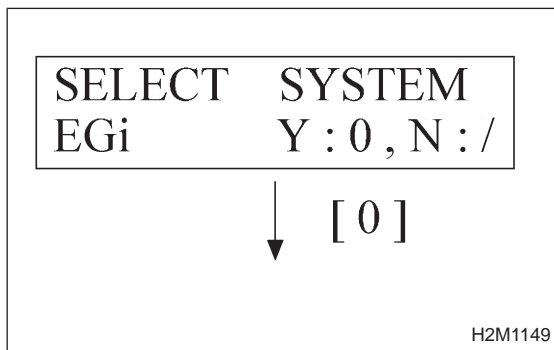

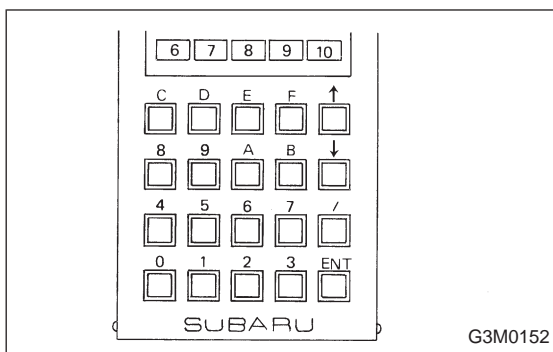

2) Designate mode using function key.
Press [F] [B] [0] [ENT] in that order.

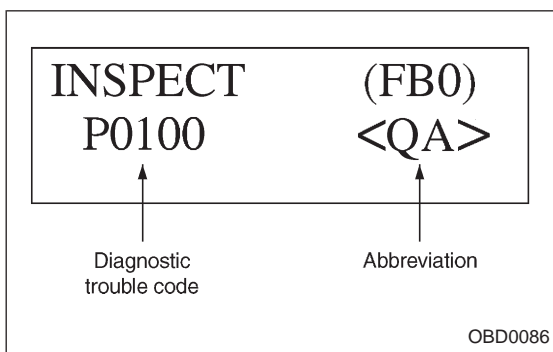

3) Ensure diagnostic trouble code(s) is shown.
(1) When there is only one diagnostic trouble code.

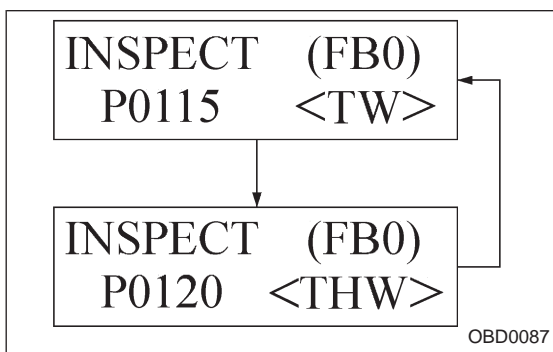

(2) When there are multiple diagnostic trouble codes.
NOTE:
For details concerning diagnostic trouble code(s), refer to the DIAGNOSTIC TROUBLE CODE (DTC) LIST, 2-7 [T10A0].

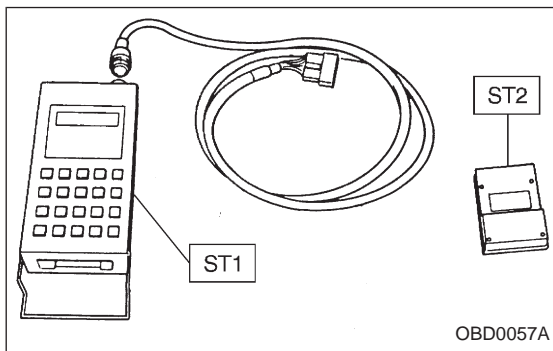

F: COMPULSORY VALVE OPERATION CHECK MODE

1. SUBARU SELECT MONITOR

- 1) Prepare Subaru select monitor and cartridge.
- ST1 498307500 SELECT MONITOR KIT
- ST2 498345700 CARTRIDGE

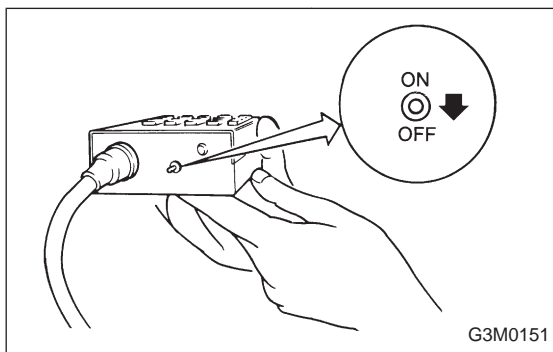

2) Turn ignition switch and Subaru select monitor switch to OFF.

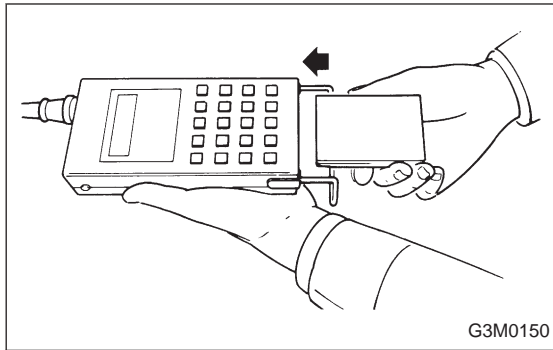

3) Insert cartridge into Subaru select monitor.

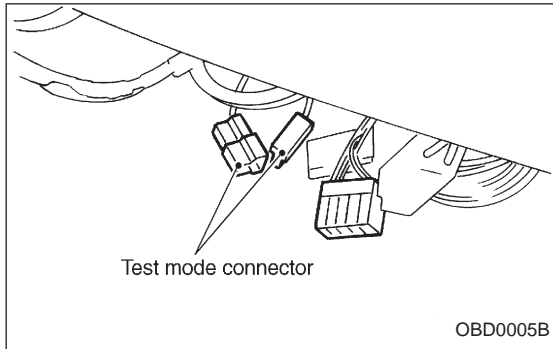

4) Connect test mode connector at the lower portion of instrument panel (on the driver's side), to the side of the center console box.

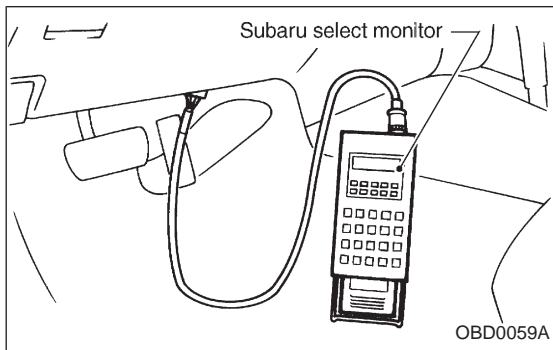

5) Connect Subaru select monitor to data link connector.
 ● Using data link connector for Subaru select monitor only:
 Connect Subaru select monitor to its data link connector located in the lower portion of the instrument panel (on the driver's side), to the side of the center console box.

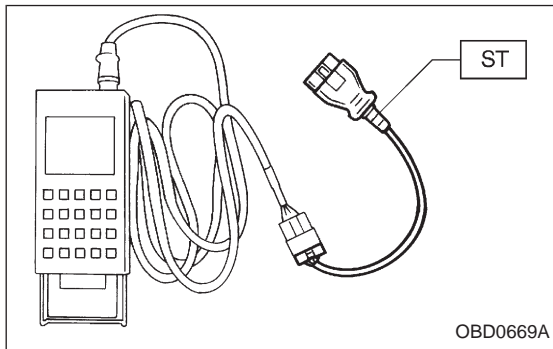

● Using data link connector for Subaru select monitor and OBD-II general scan tool:

(1) Connect ST to Subaru select monitor cable.

ST1 498357200 ADAPTER CABLE

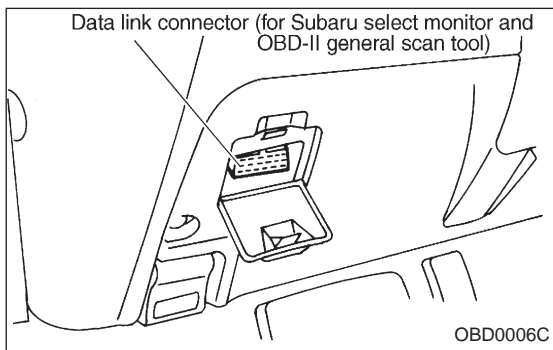

(2) Open the cover and connect Subaru select monitor to data link connector located in the lower portion of the instrument panel (on the driver's side), to the lower cover.

CAUTION:

Do not connect scan tools except for Subaru select monitor and OBD-II general scan tool.

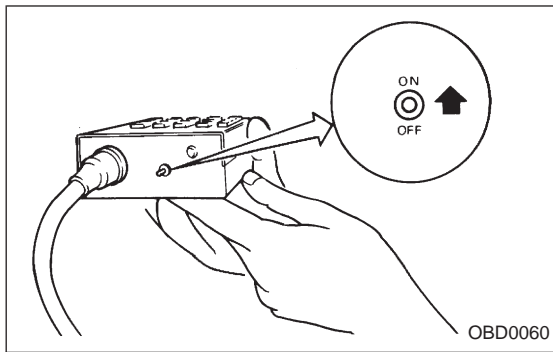

6) Turn ignition switch to ON (engine OFF) and Subaru select monitor switch to ON.

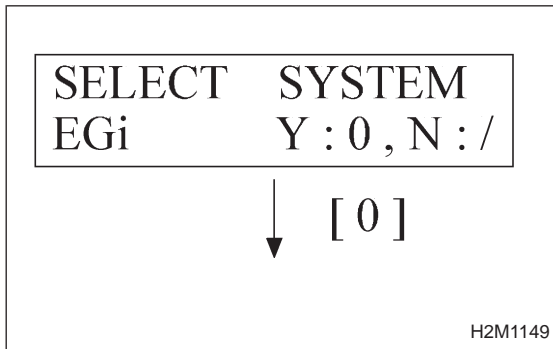

7) Select engine mode using function key. Press the function key [0].

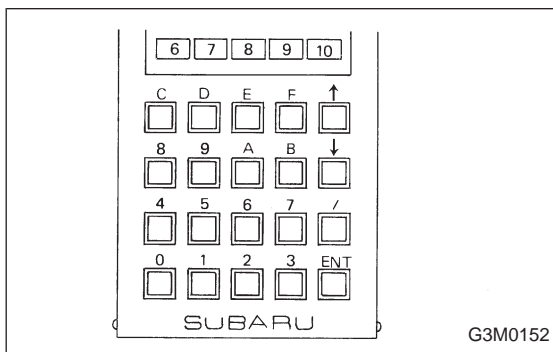

8) Designate mode using function key. Refer to "6. READ DATA FUNCTION KEY LIST FOR ENGINE" 2-7 [T3C6]. (Example: Press [F] [D] [0] [5] [ENT] in that order.)

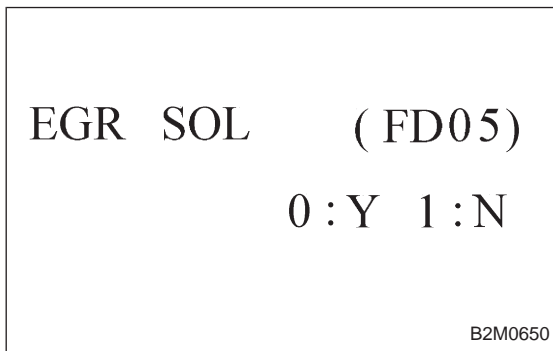

9) Ensure displayed message.



10) Press the function key.
(1) When executing, press the function key [0].

EGR SOL (FD05)

CHK 0:Y 1:N

B2M0652

EGR SOL (FD05)

0:Y 1:N

↓ [1], [ENT]

B2M0653

EGR SOL (FD05)
END OF CHECK

1996 (F00)
2.2 SOHC

B2M0643

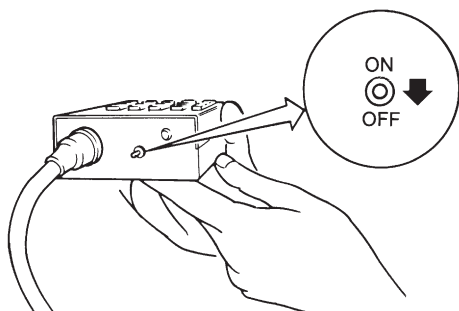

G3M0151

NOTE:

When in compulsory valve operation check mode the monitor indicates the execution of valve check on display.

(2) When not executing or stopping the compulsory valve check mode, press the function key [1].

11) When compulsory valve operation check mode is exited or check completed, the monitor indicates the completion of compulsory valve operation check on the display, and automatically returns to the initial mode (FUNCTION MODE: F00).

G: FINISHING DIAGNOSIS OPERATION**1. SUBARU SELECT MONITOR**

- 1) Disconnect test mode connector at the lower portion of instrument panel (on the driver's side), to the side of the center console box.
- 2) Turn Subaru select monitor switch and ignition switch to OFF.
- 3) Disconnect Subaru select monitor from its data link connector.