

8. Electrical Wiring Harness and Ground Point

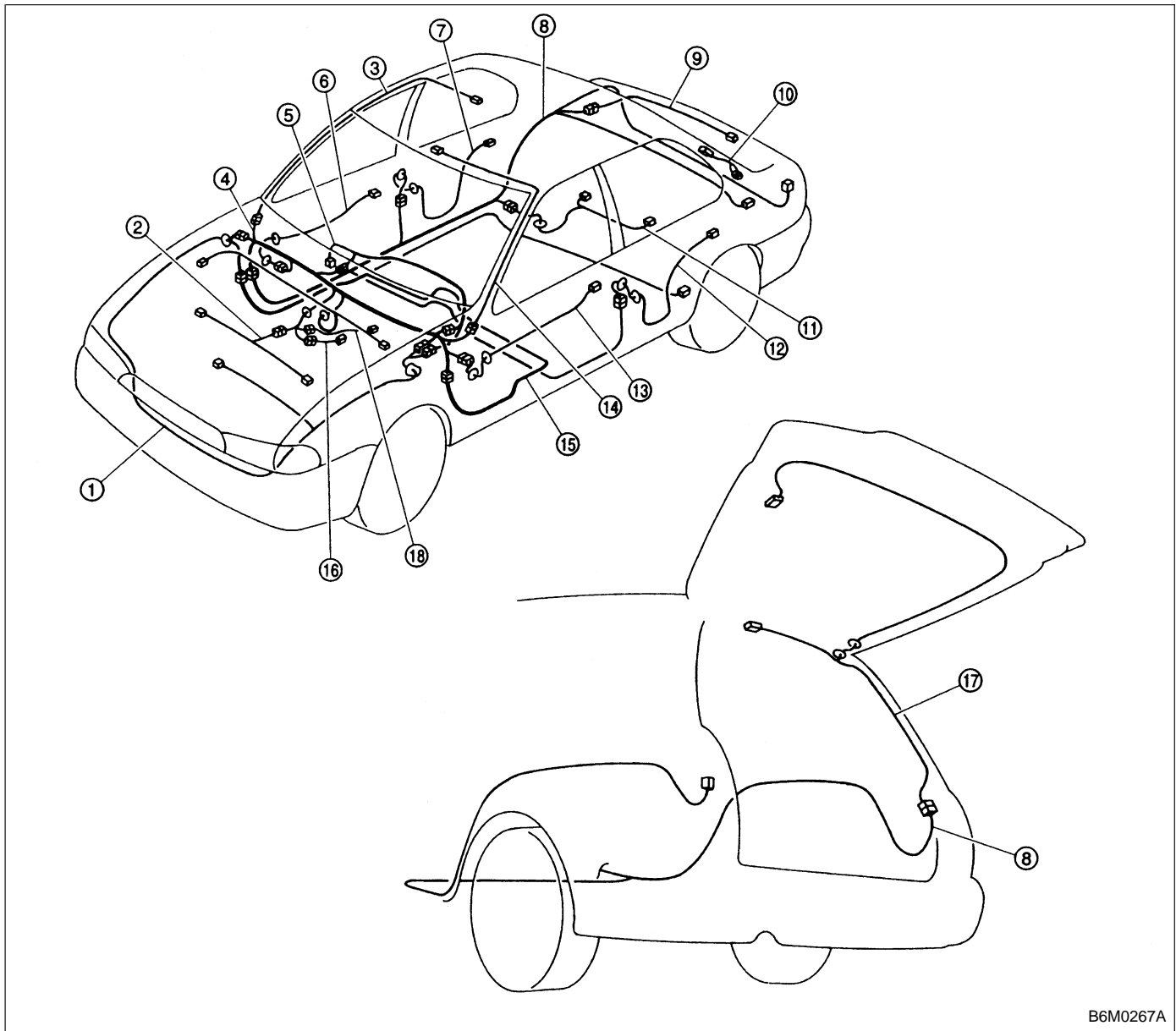

B6M0267A

- | | |
|-----------------------------------|-------------------------------------|
| ① Front wiring harness | ⑩ Rear defogger ground cord (Sedan) |
| ② Engine wiring harness | ⑪ Fuel tank cord |
| ③ Room light cord | ⑫ Rear door cord LH |
| ④ Bulkhead wiring harness | ⑬ Front door cord LH |
| ⑤ Instrument panel wiring harness | ⑭ Sunroof cord |
| ⑥ Front door cord RH | ⑮ Floor wiring harness |
| ⑦ Rear door cord RH | ⑯ Transmission cord |
| ⑧ Rear wiring harness | ⑰ Rear gate cord (Wagon) |
| ⑨ Trunk lid cord (Sedan) | ⑱ Rear oxygen sensor cord |

1. FRONT WIRING HARNESS AND GROUND POINT

● LHD model

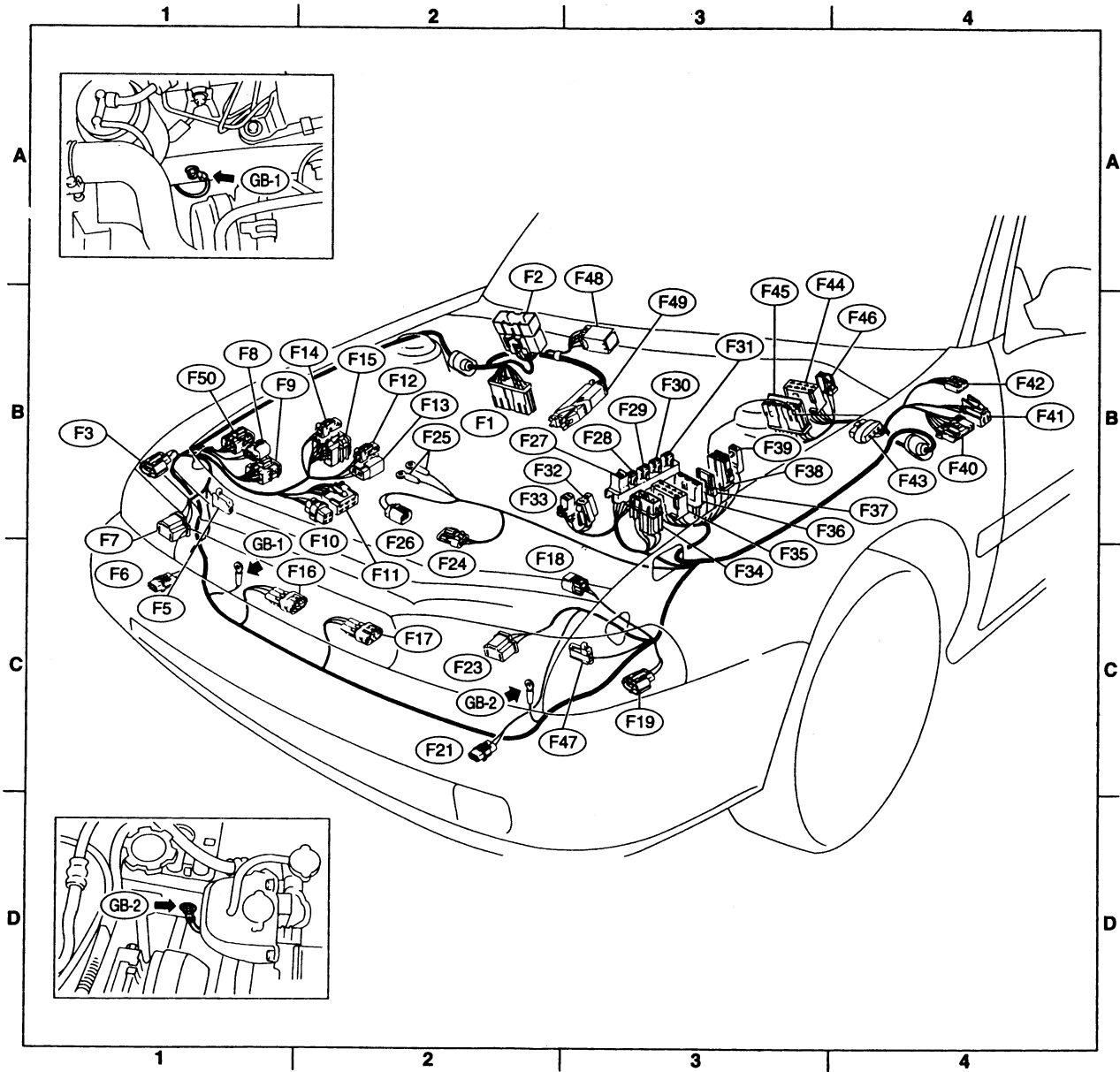

Connector				Connecting to	
No.	Pole	Color	Area	No.	Name
F1	20	Blue	B-2	P1	Floor wiring harness (With TCS model)
	12	*	B-2	P1	Floor wiring harness (With ABS model)
F2	20	Blue	B-2	B100	Bulkhead wiring harness (With ABS model)
F3	3	Brown	B-1		Front turn signal and side marker light RH
F5	1	Black	B-1		Horn
F6	2	*	C-1		Front fog light RH
	2	Brown	C-1		Front fog light RH (Outback with step roof)
F7	3	Black	B-1		Headlight RH
F8	2	Gray	B-1		Hydraulic unit (ABS)
F9	8	Gray	B-1		
F10	4	*	B-2		TCS motor relay
F11	6	*	B-2		TCS valve relay
F12	2	Black	B-2		TCS pressure switch
F13	2	Black	B-2		TCS motor
F14	2	Gray	B-2		Hydraulic unit (TCS)
F15	12	Gray	B-2		
F16	3	Black	C-1		Sub fan motor
F17	3	Black	C-2		Radiator main fan motor
F18	2	Gray	C-3		Front hood switch (Security)
F19	3	Brown	C-3		Front turn signal and side marker light LH
F21	2	*	C-2		Front fog light LH
	2	Brown	C-2		Front fog light LH (Outback with step roof)
F23	3	Black	C-2		Headlight LH
F24	3	Gray	B-2		A/C compressor
F25	1 x 2	*	B-2		Generator
F26	2	Gray	B-2		
F27	4	Black	B-3		A/C fuse (Relay holder)
F28	4	Black	B-3		A/C main fan relay-1 (Relay holder)
F29	4	Black	B-3		A/C sub fan relay-2 (Relay holder)
F30	4	Black	B-3		A/C main fan relay-2 (Relay holder)
F31	4	Black	B-3		A/C relay (Relay holder)
F32	2	Green	B-2		Front washer motor
F33	2	*	B-3		Rear washer motor
F34	4	Black	B-3		M/B
F35	8	Black	B-3		
F36	3	*	B-3		
F37	2	Black	B-3		
F38	2	Black	B-3		
F39	1	Brown	B-3		
F40	10	Gray	B-4		
F41	3	Gray	B-4		F/B
F42	5	Gray	B-4		
F43	3	Orange	B-4		A/C diode
F44	8	*	B-3	B61	Bulkhead wiring harness
F45	20	*	B-3	B62	
F46	2	Black	B-4	B108	Bulkhead wiring harness (Outback)
F47	1	Black	C-3		Horn (TAIWAN model)
F48	6	*	B-3		Shield joint connector (ABS)
F49	83	Black	B-3		ABS control module
F50	6	Black	B-1		ABS relay box

*: Non-colored

1. FRONT WIRING HARNESS AND GROUND POINT

● RHD model

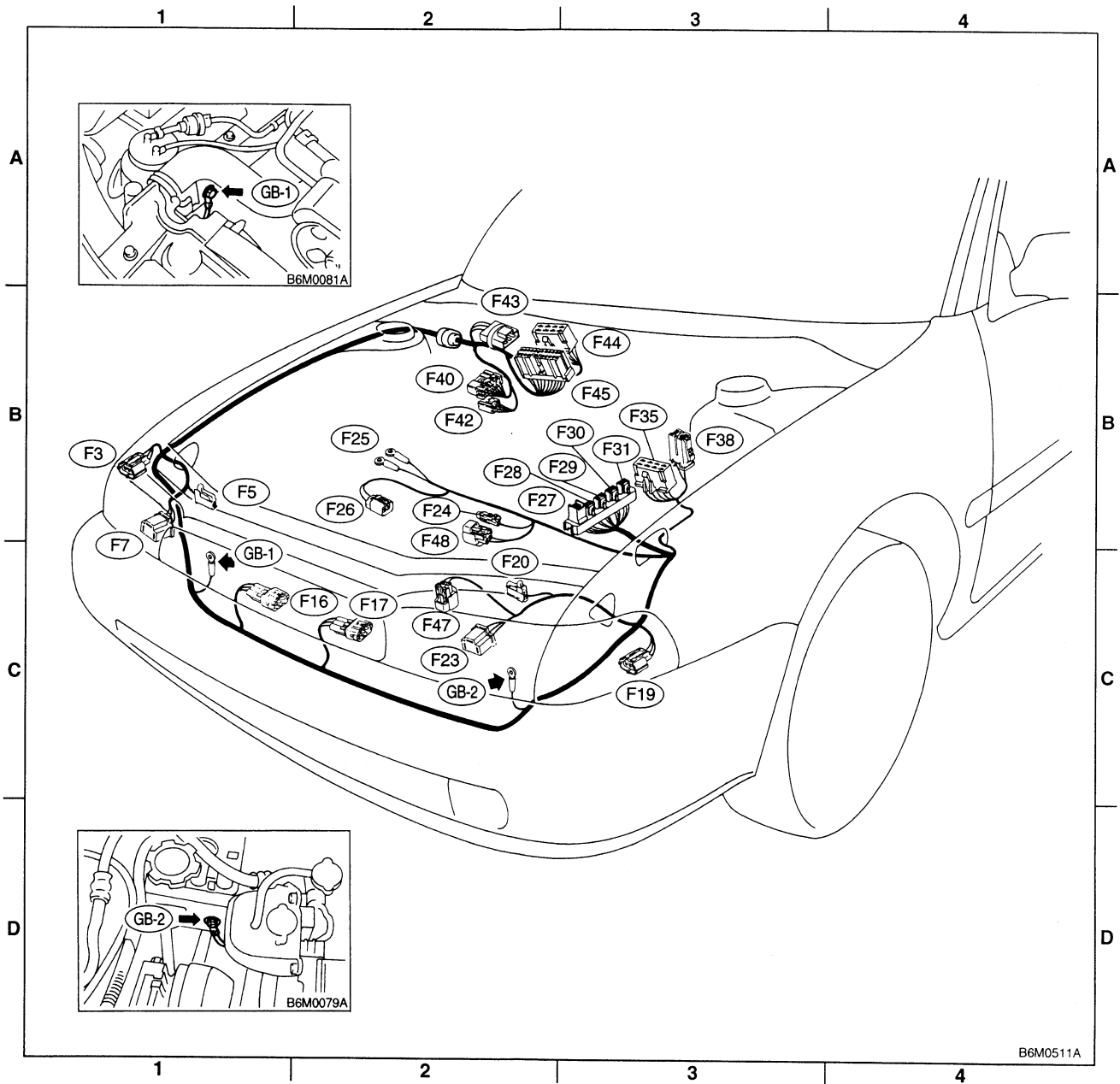

Connector				Connecting to	
No.	Pole	Color	Area	No.	Name
F3	3	Brown	B-1		Front turn signal and side marker light RH
F5	1	Black	B-1		Horn
F7	3	Black	B-1		Headlight RH
F16	3	Black	C-1		Sub fan motor
F17	3	Black	C-2		Radiator main fan motor
F19	3	Brown	C-3		Front turn signal and side marker light LH
F20	1	Black	C-2		Horn
F23	3	Black	C-2		Headlight LH
F24	1	Black	B-2		A/C compressor
F25	1 x 2	*	B-2		Generator
F26	2	Gray	B-2		
F27	4	Black	B-3		A/C fuse (Relay holder)
F28	4	Black	B-3		A/C main fan relay-1 (Relay holder)
F29	4	Black	B-3		A/C sub fan relay-2 (Relay holder)
F30	4	Black	B-3		A/C main fan relay-2 (Relay holder)
F31	4	Black	B-3		A/C relay (Relay holder)
F35	8	Black	B-3		M/B
F38	2	Black	B-3		
F40	10	Gray	B-2		F/B
F42	5	Gray	B-2		
F43	3	Orange	B-2		A/C diode
F44	8	*	B-2	B61	Bulkhead wiring harness
F45	20	*	B-2	B62	
F47	2	Gray	C-2		A/C pressure switch
F48	2	Blue	B-2		Thermal protector

*: Non-colored

2. BULKHEAD WIRING HARNESS AND GROUND POINT (IN ENGINE ROOM)

- LHD model

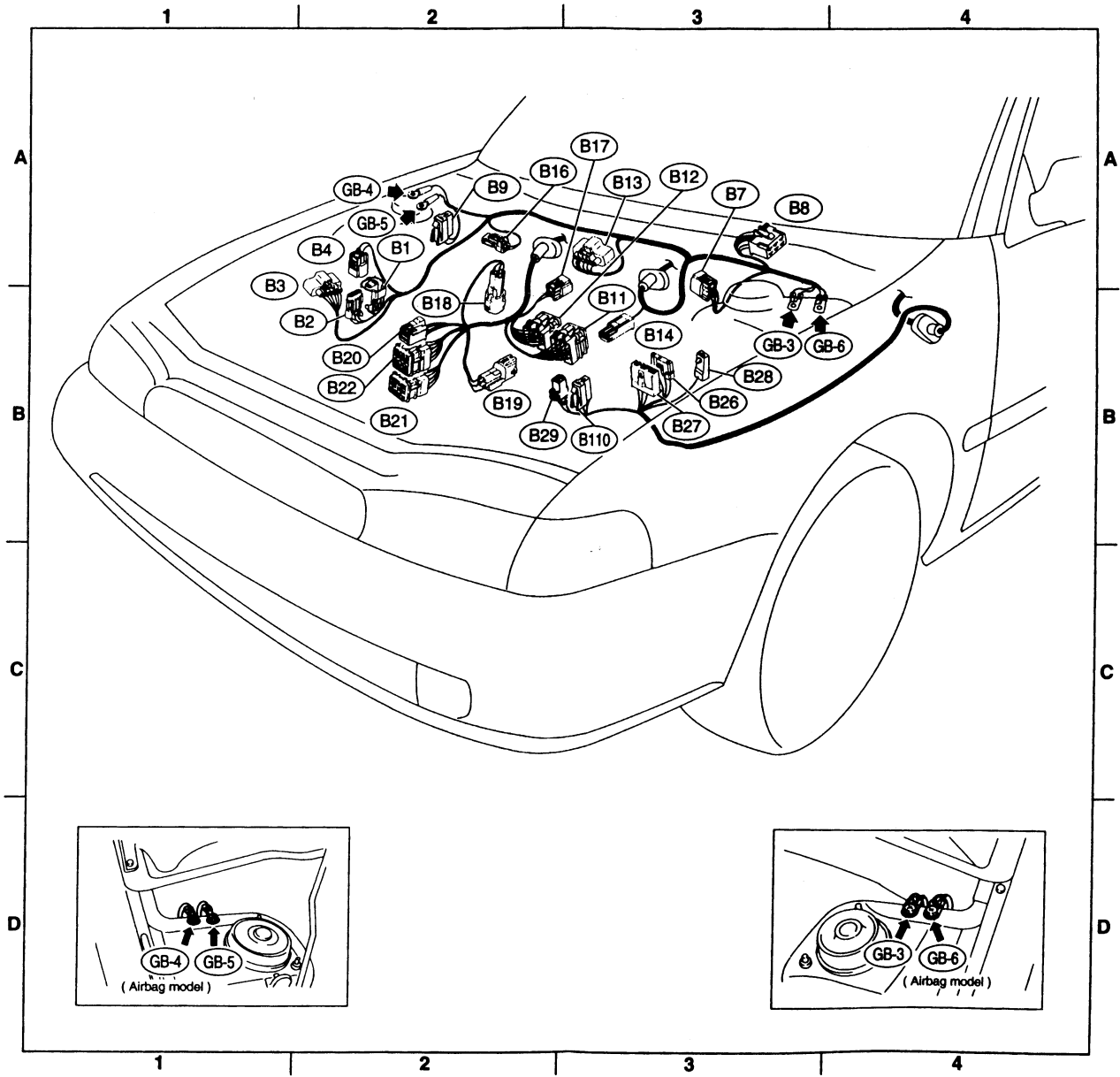

Connector				Connecting to	
No.	Pole	Color	Area	No.	Name
B1	2	*	B-2		Pressure source switching solenoid
B2	3	Black	B-2		Pressure sensor
B3	5	Gray	B-2		Mass air flow sensor
B4	2	Gray	B-2		AT dropping resistor
B5	2	Gray	B-2		Resistor (Daytime running light)
B6	2	Gray	B-2		ABS front sensor RH
	2	Brown	B-2		ABS front sensor RH (Outback with step roof)
B7	4	*	B-2		Cruise control pump
B8	6	*	A-2		Front wiper motor
B9	2	Black	A-2		FWD switch (AT)
B10	2	Brown	B-2		A/C pressure switch
B11	16	Gray	B-3	T4	Transmission (AT)
B12	12	Gray	B-2	T3	
B13	6	Gray	B-3		Ignitor
B14	1	Black	B-3		Starter (Magnet)
B15	2	Gray	B-3		ABS front sensor LH
	2	Brown	B-3		ABS front sensor LH (Outback with step roof)
B16	2	Gray	B-3		Brake fluid level switch
B17	2	Black	B-2		Vehicle speed sensor
B18	3	Dark gray	B-2		Front oxygen sensor
B19	4	*	B-2	T5	Rear oxygen sensor cord (Other models)
	4	*	B-2		Rear oxygen sensor (California model)
B20	6	Light gray	B-2	E1	Engine wiring harness
B21	12	Light gray	B-2	E2	
B22	16	Light gray	B-2	E3	
B24	2	Gray	B-2	T1	Back-up light switch (MT)
B25	2	Brown	B-2	T2	Neutral position switch (MT)

*: Non-colored

2. BULKHEAD WIRING HARNESS AND GROUND POINT (IN ENGINE ROOM)

- RHD model

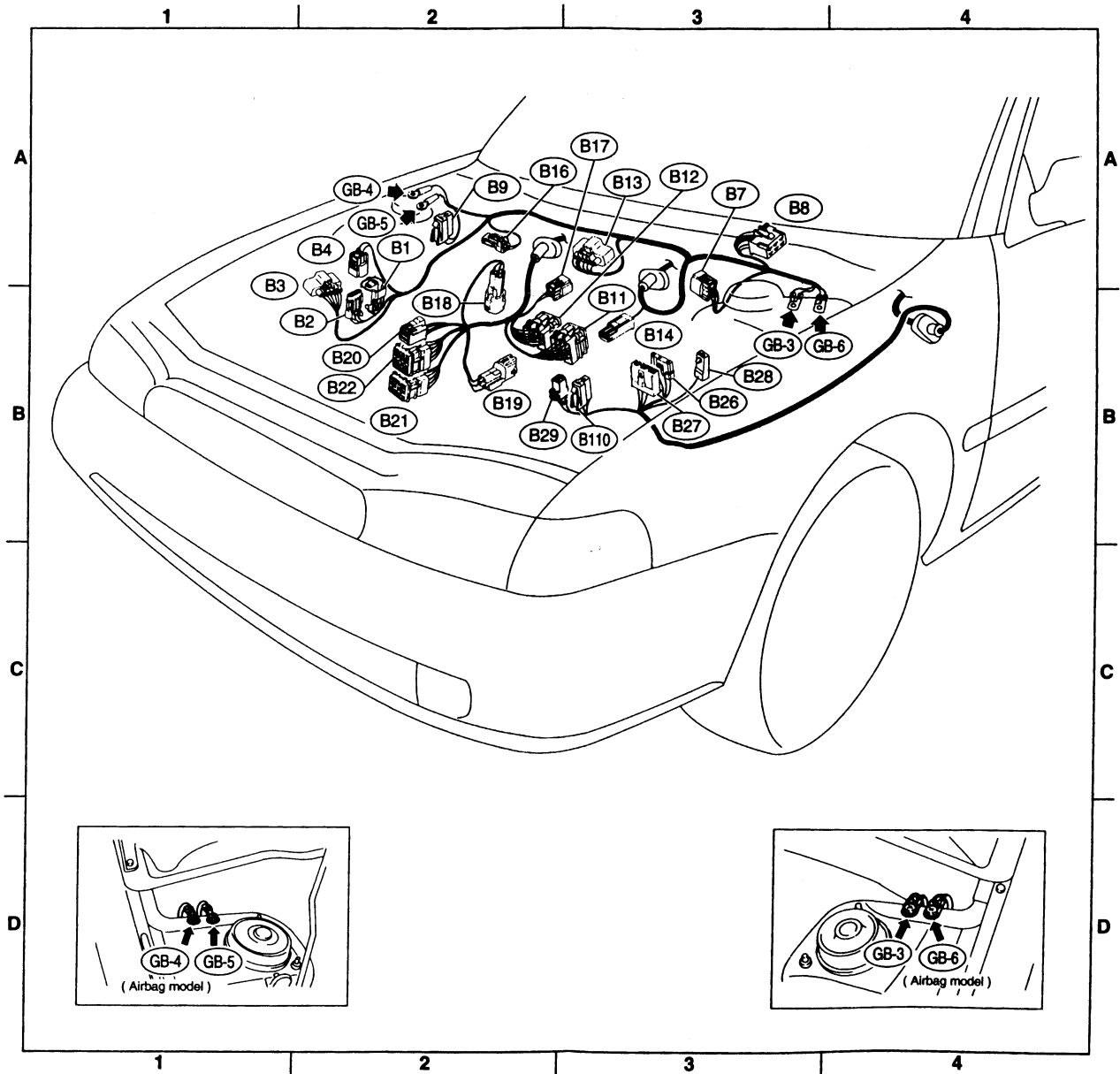

Connector				Connecting to	
No.	Pole	Color	Area	No.	Name
B1	2	Brown	B-2		Pressure sources switching solenoid
B2	3	Black	B-2		Pressure sensor
B3	5	Gray	B-2		Mass air flow sensor
B4	2	Gray	B-2		AT dropping resistor
B7	4	Gray	B-3		Cruise control pump
B8	6	*	B-3		Front wiper motor
B9	2	Black	A-2		FWD switch
B11	16	Gray	B-3	T4	Transmission
B12	12	Gray	B-2	T3	
B13	6	Gray	B-3		Ignitor
B14	1	Black	B-3		Starter (Magnet)
B16	2	Gray	B-2		Brake fluid level switch
B17	2	Black	B-3		Vehicle speed sensor
B18	3	Dark gray	B-2		Front oxygen sensor
B19	4	*	B-2	T5	Rear oxygen sensor cord (Other models)
	4	*	B-2		Rear oxygen sensor (California model)
B20	6	Light gray	B-2	E1	Engine wiring harness
B21	12	Light gray	B-2	E2	
B22	16	Light gray	B-2	E3	
B26	2	Black	B-3		M/B
B27	3	*	B-3		
B28	1	Brown	B-3		
B29	2	*	B-2		Rear washer motor
B110	2	Green	B-3		Front washer motor

*: Non-colored

3. ENGINE WIRING HARNESS, TRANSMISSION CORD AND GROUND POINT

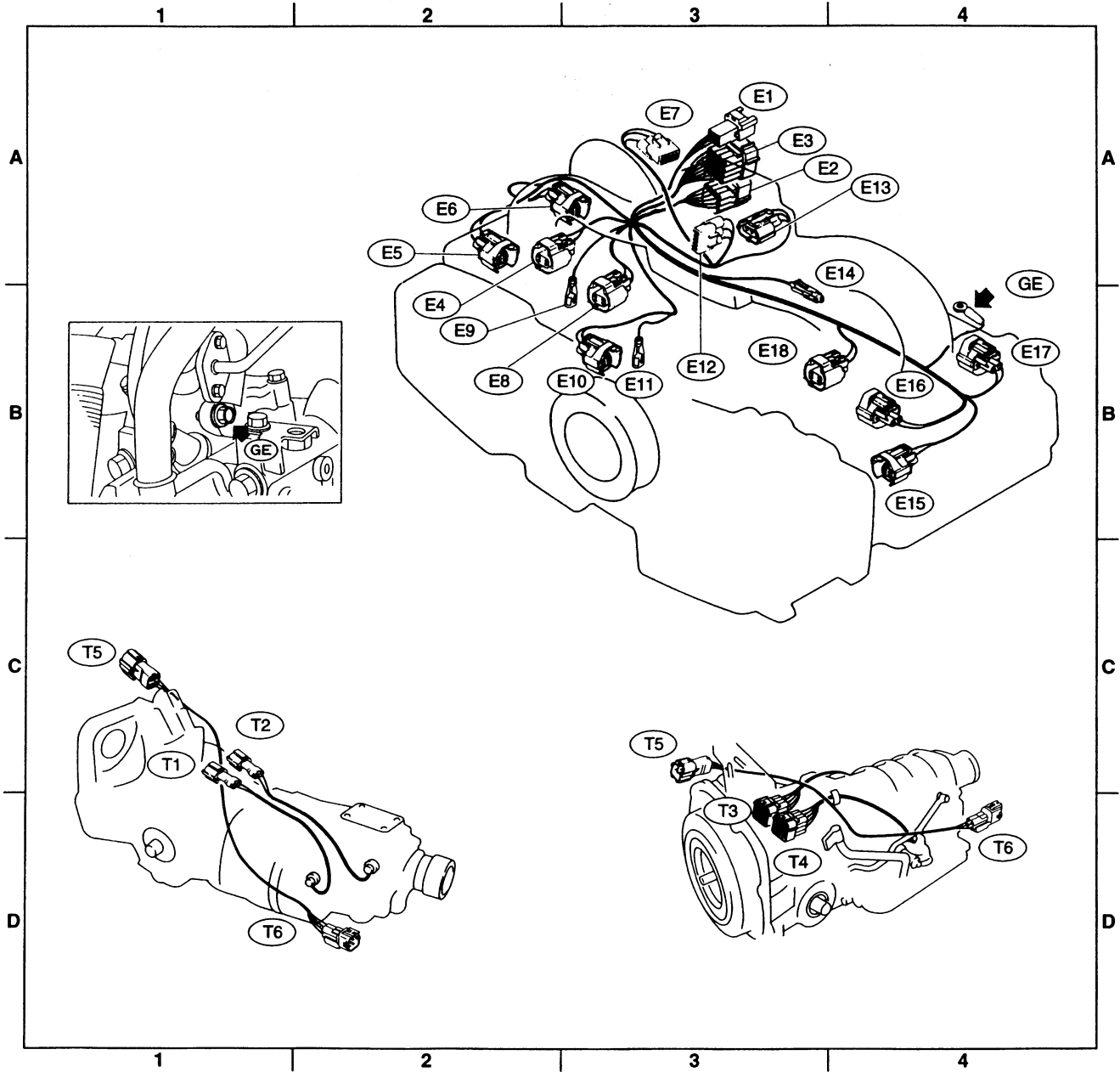

Connector				Connecting to	
No.	Pole	Color	Area	No.	Name
E1	6	*	A-3	B20	Bulkhead wiring harness
E2	12	Gray	A-3	B21	
E3	16	Gray	A-3	B22	
E4	2	Blue	A-2		Purge control solenoid valve
E5	2	Light gray	A-2		Injector #1
E6	2	Dark gray	A-3		Injector #3
E7	3	Gray	A-3		Idle air control solenoid valve
E8	2	Brown	B-3		Engine coolant temperature sensor
E9	1	*	B-3		Thermometer
E10	2	Gray	B-3		Crankshaft position sensor
E11	1	*	B-3		Oil pressure switch
E12	3	Gray	A-3		Ignition coil
E13	3	Brown	A-3		Throttle position sensor
E14	1	Gray	B-3		Knock sensor
E15	2	Dark gray	B-4		Camshaft position sensor
E16	2	Light gray	B-4		Injector #2
E17	2	Dark gray	B-4		Injector #4
E18	2	Brown	B-3		EGR solenoid (AT)

*: Non-colored

Connector				Connecting to	
No.	Pole	Color	Area	No.	Name
T1	2	Gray	C-1	B24	Bulkhead wiring harness (MT)
T2	2	Brown	C-1	B25	
T3	12	Gray	D-3	B12	Bulkhead wiring harness (AT)
T4	16	Gray	D-3	B11	
T5	4	Gray	C-1/C-3	B19	Bulkhead wiring harness
T6	4	Gray	D-2/D-4		Rear oxygen sensor

4. BULKHEAD WIRING HARNESS (IN COMPARTMENT)

- LHD model

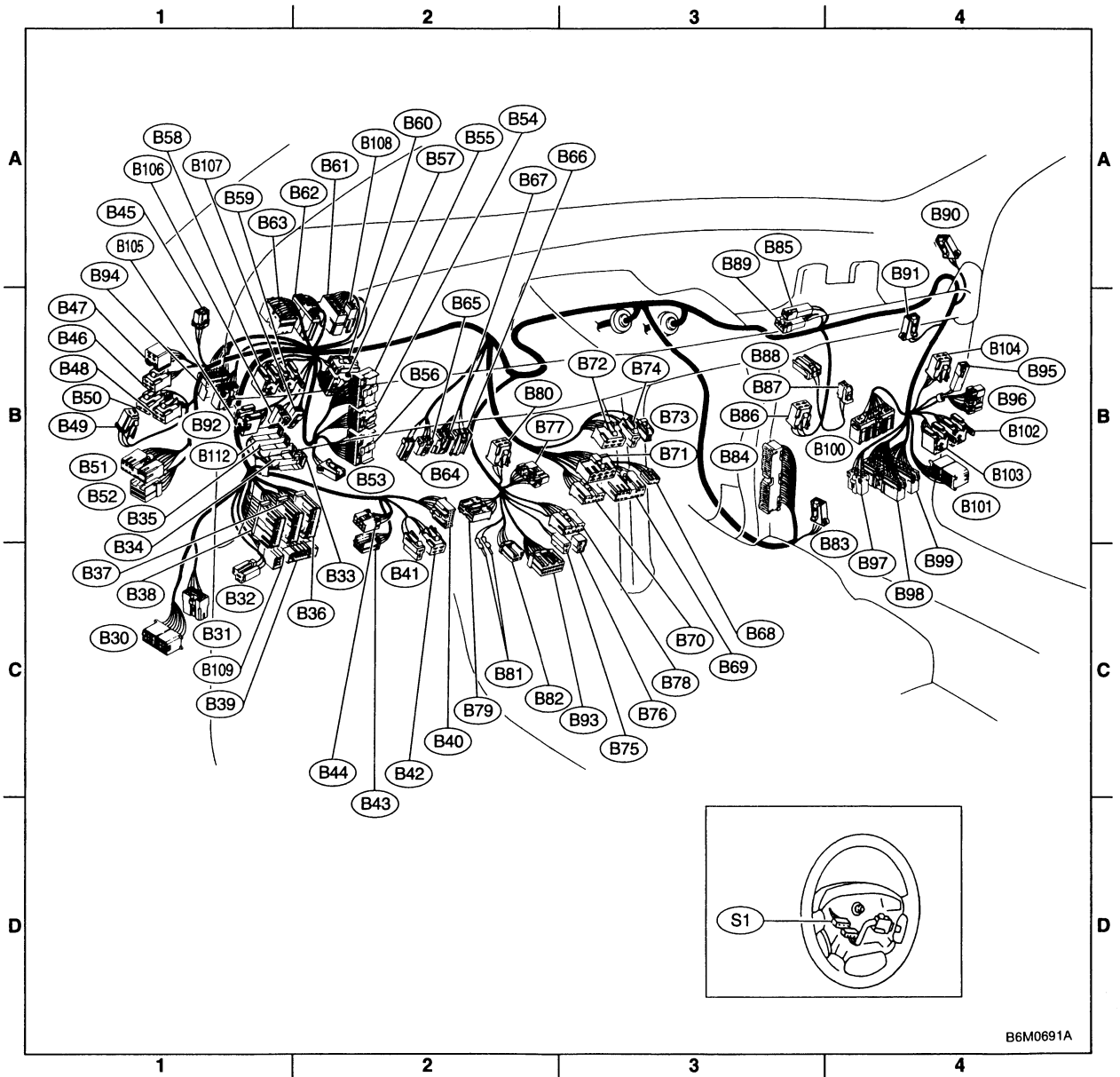

Connector				Connecting to	
No.	Pole	Color	Area	No.	Name
B30	24	*	C-1	D1	Front door cord LH
B31	7	Yellow	C-1	AB1	SRS (Airbag) harness
B32	3	Black	C-1		Turn & hazard module
B33	4	Brown	B-1		Diode (Brake fluid level)
B34	3	*	B-1		Diode (Door warning)
B35	2	Black	B-1		Diode (Step light)
B36	22	Black	C-1	i1	Instrument panel wiring harness
B37	22	*	C-1	i2	
B38	22	Brown	C-1	i3	
B39	20	Blue	C-1	i4	
B40	16	Gray	C-2		OBID-II service connector
B41	2	*	C-2		Power window circuit breaker
B42	4	*	C-2		Power window and sunroof relay
B43	6	Black	C-2		Illumination control module
B44	8	*	C-2		Seat belt timer
B45	4	*	B-1	R53	Sunroof cord
B46	4	Green	B-1		Fuel pump relay
B47	6	Brown	B-1		Main relay
B48	4	Blue	B-1		Front fog light relay
B49	3	Black	B-1		Horn relay
B50	4	*	B-1		Blower relay
B51	11	Gray	B-1		F/B
B52	12	Gray	B-1		
B53	4	*	B-2		Shield joint connector (AT)
B54	12	Black	B-2		Transmission control module
B55	16	Black	B-2		
B56	20	Black	B-2		
B57	12	Black	B-2		Shift-lock control module
B58	5	Black	B-1		Headlight alarm relay (Security)
B59	5	Black	B-1		Interrupt relay (Security)
B60	4	*	B-2		Shield joint connector (With TCS model)
B61	8	*	B-2	F44	Front wiring harness
B62	20	*	B-1	F45	
B63	40	Gray	B-1	P10	Floor harness (With TCS model)
B64	2	Black	B-2		Stop light switch
B65	4	Black	B-2		Stop & brake switch (With cruise control)
B66	3	Black	B-2		Pedal stroke sensor (TCS)
B67	4	Black	B-2		Pedal stroke switch (TCS)
B68	5	Black	B-3		Slip ring
B69	11	Black	B-3		Combination switch
B70	9	*	B-3		
B71	8	*	B-3		
B72	6	Black	B-3		Ignition switch

Connector				Connecting to	
No.	Pole	Color	Area	No.	Name
B73	2	Black	B-3		Key lock solenoid (AT)
B74	2	Black	B-3		Key warning switch
B75	2	Green	C-2	B76	Test mode connector
B76	2	Green	C-3	B75	
B77	10	Brown	B-2		Mode actuator
B78	9	Yellow	C-2		Data link connector
B79	14	Gray	C-2		Check connector
B80	4	Blue	B-2	i20	Instrument panel wiring harness
B81	1 x 2	*	C-2		Diagnosis terminal (Ground)
B82	6	Black	C-2		Diagnosis connector
B83	4	*	C-3		Shield joint connector (E/G)
B84	96	Light blue	B-3		Engine control module
B85	2	Black	B-3		Diode (Lighting)
B86	4	*	B-3		Blower motor resistor
B87	2	*	B-3		Blower motor
B88	3	Black	B-3		Evaporator thermostatswitch
B89	4	Brown	B-3		Diode (Security)
B90	4	*	B-4	R50	Room light cord
B91	4	*	B-4		FRESH/RECIRC actuator
B92	8	*	B-4		Door lock timer
B93	16	Black	B-4		Security control module
B94	20	Black	B-4		Cruise control module
B95	2	Black	B-4		Diode (Daytime running light)
B96	10	*	B-4		Daytime running light control module
B97	8	*	B-4	R1	Rear wiring harness
B98	24	Black	B-4	R2	
B99	24	*	B-4	R3	
B100	20	Blue	B-4	F2	Front wiring harness (With ABS model)
B101	24	*	B-4	D11	Front door cord RH
B102	5	Black	B-4		Daytime running light relay
B103	4	Blue	B-4		High-beam relay (Daytime running light)
B104	4	Pink	B-4		Rear power supply relay
B105	4	Blue	B-1		Starter interlock relay (MT)
B106	2	*	B-1		Clutch switch (MT)
B107	2	Blue	B-1		Clutch switch (Cruise control)
B108	2	Black	B-2	F46	Front wiring harness (Outback)
B109	4	Black	C-1		Fuse holder (Outback)
B112	2	Black	B-1		Diode (Front fog light)

*: Non-colored

Connector				Connecting to	
No.	Pole	Color	Area	No.	Name
S1	3	White	D-3		Cruise control sub switch

4. BULKHEAD WIRING HARNESS (IN COMPARTMENT)

- RHD model

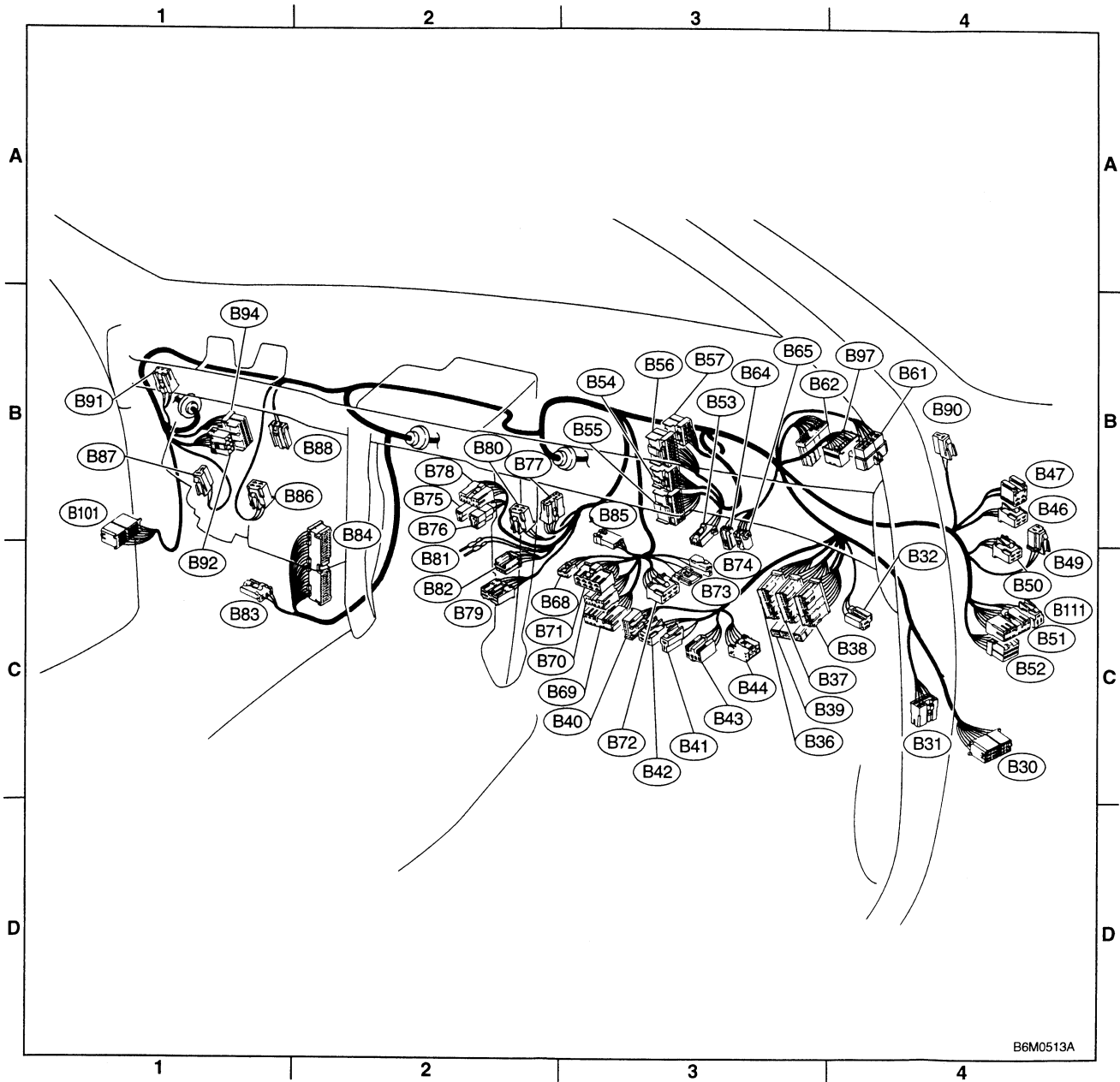

Connector				Connecting to	
No.	Pole	Color	Area	No.	Name
B30	24	*	C-4	D1	Front door cord RH
B31	7	Yellow	C-4	AB1	SRS (Airbag) harness
B32	3	Black	C-4		Turn & hazard module
B36	22	Black	C-3	i1	Instrument panel wiring harness
B37	22	*	C-3	i2	
B38	22	Brown	C-3	i3	
B39	20	Blue	C-3	i4	
B40	16	Gray	C-3		OBD-II service connector
B41	2	*	C-3		Power window circuit breaker
B42	4	*	C-3		Power window relay
B43	6	Black	C-3		Illumination control module
B44	8	*	C-3		Seat belt timer
B46	4	Green	B-4		Fuel pump relay
B47	6	Brown	B-4		Main relay
B49	3	Black	B-4		Horn relay
B50	4	*	B-4		Blower relay
B51	11	Gray	C-4		F/B
B52	12	Gray	C-4		
B53	4	*	B-3		Shield joint connector (AT)
B54	12	Black	B-3		Transmission control module
B55	16	Black	B-3		
B56	20	Black	B-3		
B57	12	Black	B-3		Shift-lock control module
B61	8	*	B-4	F44	Front wiring harness
B62	20	*	B-4	F45	
B64	2	Black	B-3		Stop light switch
B65	4	Black	B-3		Stop & brake switch (With cruise control)
B68	5	Black	B-3		Cruise control sub switch

Connector				Connecting to	
No.	Pole	Color	Area	No.	Name
B69	11	Black	C-3		Combination switch
B70	9	*	C-3		
B71	8	*	B-3		
B72	6	Black	C-3		Ignition switch
B73	2	Black	B-3		Key lock solenoid
B74	2	Black	B-3		Key warning switch
B75	2	Green	B-2	B76	Test mode connector
B76	2	Green	B-2	B75	
B77	7	*	B-2		Mode actuator
B78	9	Yellow	B-2		Data link connector
B79	14	Gray	C-2		Check connector
B80	4	Blue	B-2	i20	Instrument panel wiring harness
B81	1 x 2	*	B-2		Diagnosis terminal (Ground)
B82	6	Black	B-2		Diagnosis connector
B83	4	*	C-1		Shield joint connector (E/G)
B84	96	Light blue	C-2		Engine control module
B85	4	Brown	B-3		Diode (Lighting)
B86	4	Black	B-1		Blower motor resistor
B87	2	Black	B-1		Blower motor
B88	3	Black	B-1		Evaporator thermoswitch
B90	2	Green	B-4	R50	Room light cord
B91	5	*	B-1		FRESH/RECIRC actuator
B92	8	*	B-1		Door lock timer
B94	20	Black	B-1		Cruise control module
B97	56	*	B-4	R1	Rear wiring harness (S.M.J.)
B101	24	*	B-1	D11	Front door cord LH
B111	3	Gray	C-4		F/B

*: Non-colored

5. INSTRUMENT PANEL WIRING HARNESS AND GROUND POINT

● LHD model

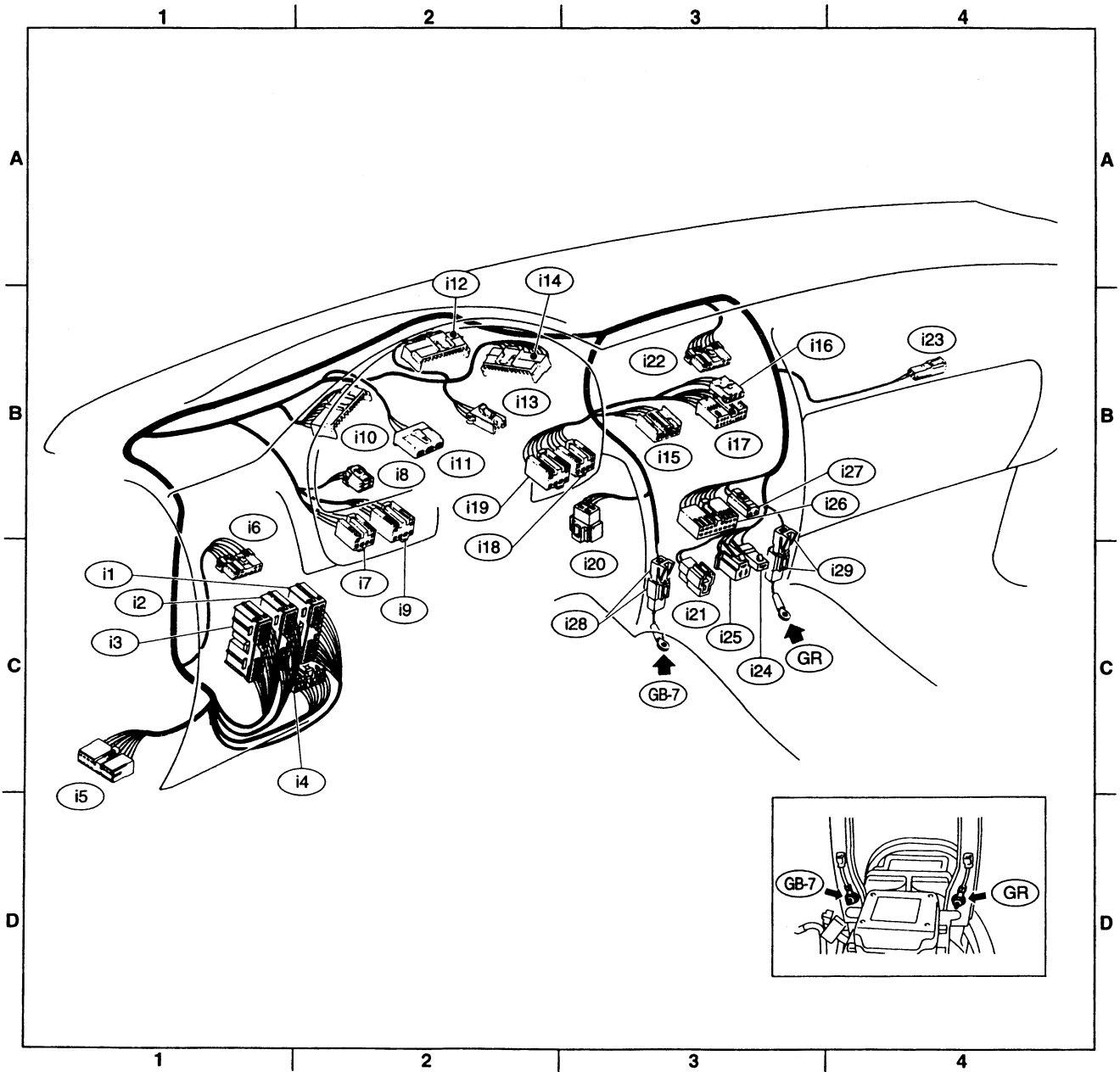

Connector				Connecting to	
No.	Pole	Color	Area	No.	Name
i1	22	Black	C-2	B36	Bulkhead wiring harness
i2	22	*	C-1	B37	
i3	22	Brown	C-1	B38	
i4	20	Blue	C-2	B39	
i5	15	Gray	C-1		F/B
i6	10	*	C-1		Remote control rearview mirror switch
i7	6	Yellow	B-2		Front fog light switch
i8	4	Brown	B-2		Security indicator light
i9	6	*	B-2		T.C.S. off switch
i10	16	Light gray	B-2		Combination meter
i11	3	*	B-2		
i12	16	Light gray	B-2		Combination meter
i13	4	*	B-2		Combination meter (Airbag warning)
i14	13	*	B-2		Combination meter
i15	6	*	B-3		Fan switch
i16	3	*	B-3		A/C switch
i17	16	*	B-3		Mode control panel
i18	6	*	B-3		Rear defogger switch
i19	6	Brown	B-2		Cruise control main switch
i20	4	Blue	B-3	B80	Bulkhead wiring harness
i21	2	Black	C-3		Ash tray illumination light
i22	10	*	B-3		Hazard switch
i23	2	Brown	B-4		Glove box illumination light
i24	1	*	C-3		Cigarette lighter
i25	3	*	C-3		
i26	14	*	B-3		Radio
i27	2	*	B-3		CD player illumination light
i28	1	Black	C-3		Ground
i29	1	Black	C-3		Ground (Radio)

*: Non-colored

5. INSTRUMENT PANEL WIRING HARNESS AND GROUND POINT

● RHD model

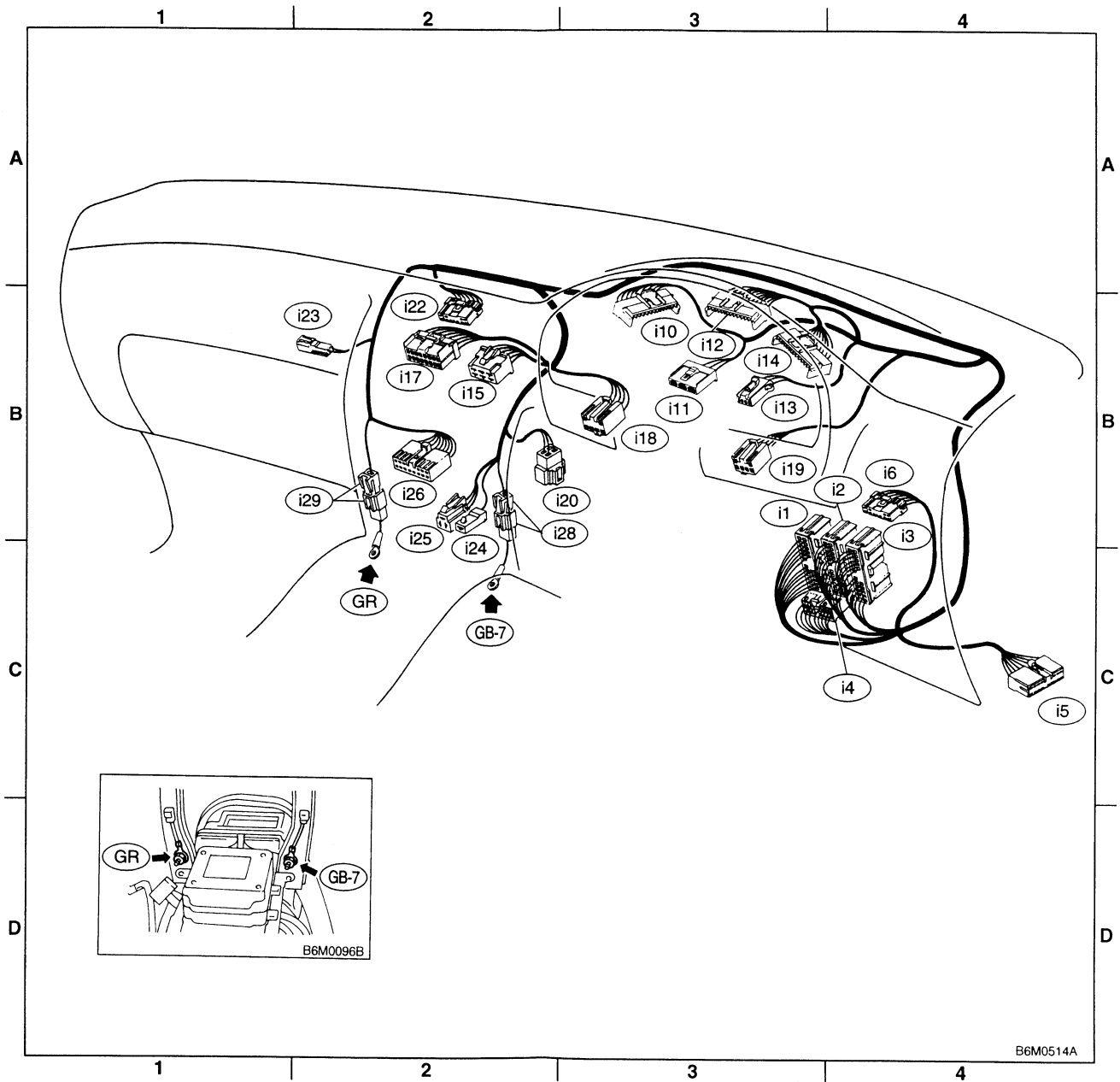

Connector				Connecting to	
No.	Pole	Color	Area	No.	Name
i1	22	Black	C-4	B36	Bulkhead wiring harness
i2	22	*	C-4	B37	
i3	22	Brown	C-4	B38	
i4	20	Blue	C-4	B39	
i5	15	Gray	C-4		F/B
i6	10	*	C-4		Remote control rearview mirror switch
i10	16	Light gray	B-3		Combination meter
i11	3	*	B-3		
i12	16	Light gray	B-3		Combination meter
i13	4	*	B-3		Combination meter (Airbag warning)
i14	13	*	B-3		Combination meter
i15	6	*	B-2		Fan switch
i17	16	Black	B-2		Mode control panel
i18	6	*	B-3		Rear defogger switch
i19	6	Brown	B-3		Cruise control main switch
i20	4	Blue	B-2	B80	Bulkhead wiring harness
i22	10	*	B-2		Hazard switch
i23	2	Brown	B-2		Glove box illumination light
i24	1	*	C-2		Cigarette lighter
i25	3	*	C-2		
i26	14	*	B-2		Radio
i28	1	Black	C-2		Ground
i29	1	Black	C-2		Ground (Radio)

*: Non-colored

6. REAR WIRING HARNESS AND GROUND POINT

- LHD model

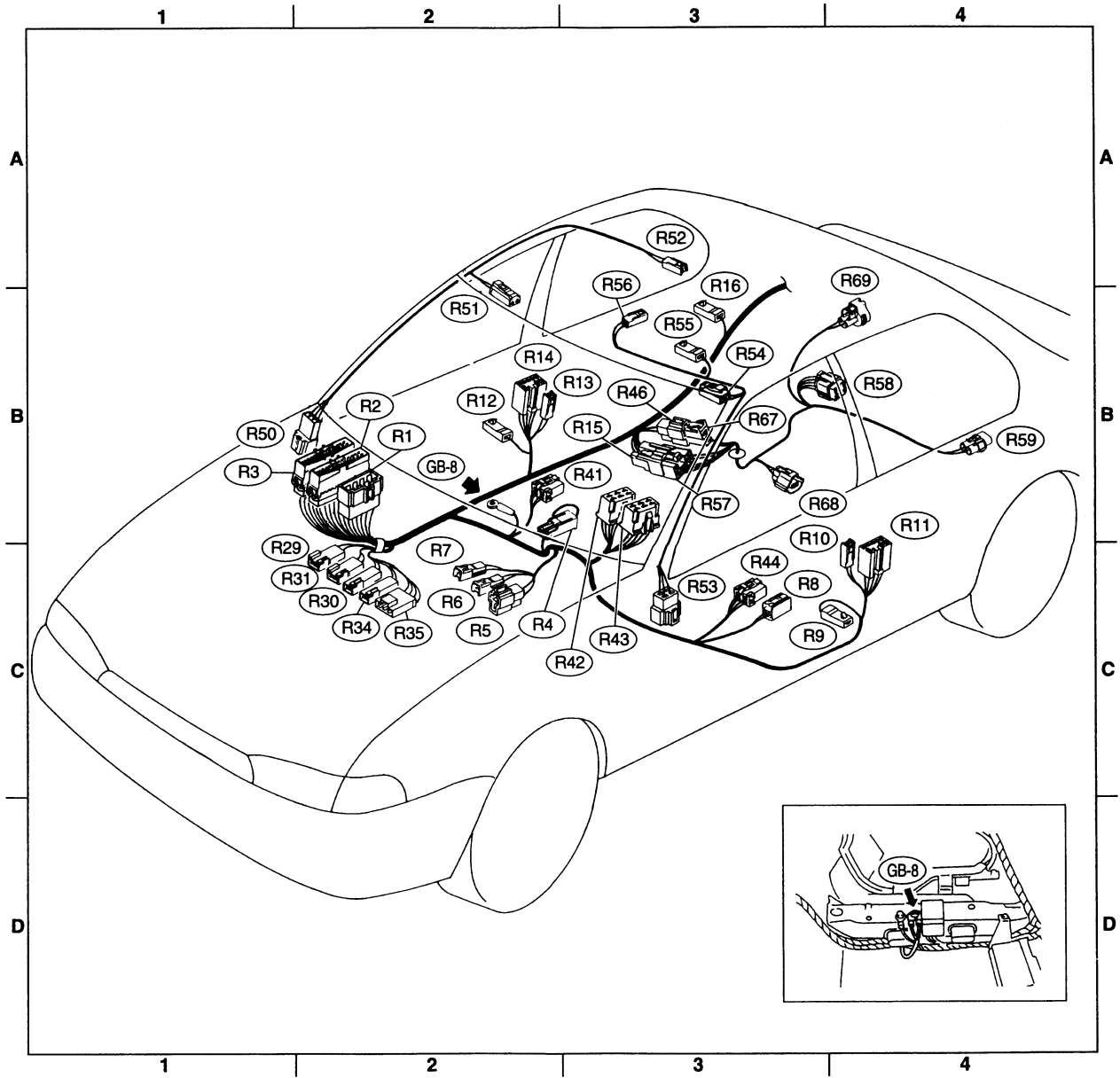

Connector				Connecting to	
No.	Pole	Color	Area	No.	Name
R1	8	*	B-2	B97	Bulkhead wiring harness
R2	24	Black	B-2	B98	Bulkhead wiring harness
R3	24	*	B-2	B99	
R4	1	Black	B-2		Parking brake switch
R5	2	*	C-2		Select lever illumination light (AT)
R6	2	Black	C-2		Shift lock solenoid (AT)
R7	2	*	C-2		P position switch (AT)
R8	2	*	C-3		Seat belt switch
R9	1	Brown	C-4		Front door switch LH
R10	2	*	C-4	D22	Rear door cord LH (Security)
R11	8	*	C-4	D21	Rear door cord LH
R12	1	Brown	B-2		Front door switch RH
R13	2	*	B-2	D28	Rear door cord RH (Security)
R14	8	*	B-2	D27	Rear door cord RH
R15	8	*	B-3	R57	Fuel tank cord
R16	1	Brown	B-3		Rear door switch RH
R29	3	*	C-2		Diode (Security) (Wagon)
R30	2	Black	C-2		Diode (Rear gate latch switch) (Wagon) without security
R31	3	*	C-2		Diode (Security)
R34	2	Black	C-2		Diode (Security) (Wagon)
R35	3	Orange	C-2		Diode (Security) (Sedan)
R41	4	Blue	B-2		Seat heater (Passenger)
R42	6	*	B-3		Seat heater switch (Passenger)
R43	6	Blue	B-3		Seat heater switch (Driver)
R44	4	Blue	C-3		Seat heater (Driver)
R46	2	*	B-3	R67	Fuel tank cord
R50	4	*	B-2	B90	Bulkhead wiring harness
R51	2	*	B-2		Vanity mirror illumination light RH
R52	2	*	A-3		Room light
R53	4	*	C-3	B45	Bulkhead wiring harness
R54	2	*	B-3		Vanity mirror illumination light LH
R55	1	*	B-3		Sunroof control module
R56	2	*	B-3		Spot light
R57	8	*	B-3	R15	Rear wiring harness
R58	6	*	B-3		Fuel gauge module & fuel pump
R59	2	*	B-4		Fuel gauge sub module (AWD)
R67	2	*	B-3	R46	Rear wiring harness
R68	2	*	B-3		Pressure control solenoid valve
R69	2	*	B-3		Vent control solenoid valve

*: Non-colored

6. REAR WIRING HARNESS AND GROUND POINT

- RHD model

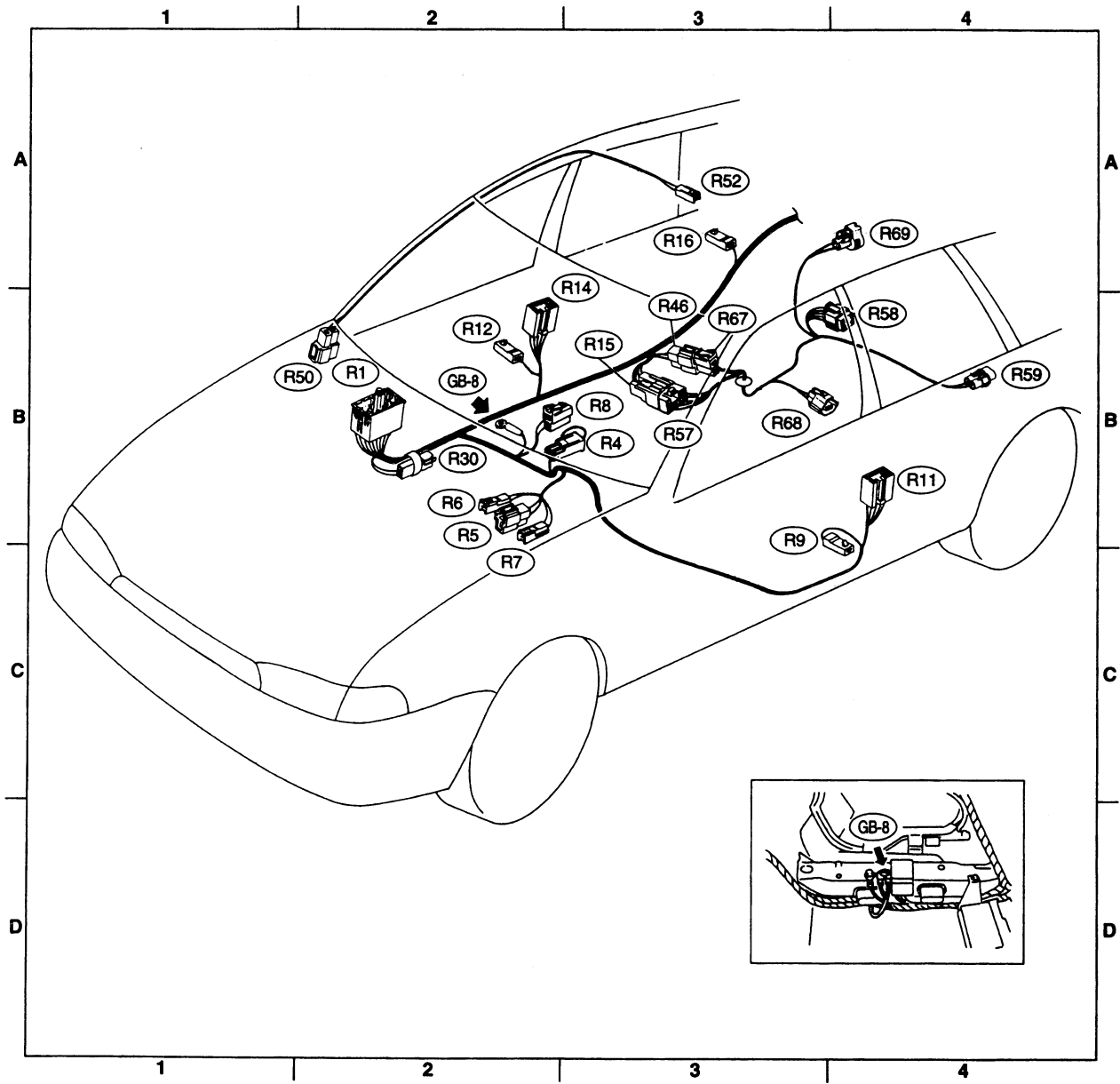

Connector				Connecting to	
No.	Pole	Color	Area	No.	Name
R1	56	*	B-2	B97	Bulkhead wiring harness (S.M.J.)
R4	1	Black	B-2		Parking brake switch
R5	2	*	B-2		Select lever illumination light
R6	2	Black	B-2		Shift lock solenoid
R7	2	*	B-2		P position switch
R8	2	*	B-2		Seat belt switch
R9	1	Brown	B-3		Front door switch LH
R11	8	*	B-4	D21	Rear door cord LH
R12	1	Brown	B-2		Front door switch RH
R14	8	*	B-2	D27	Rear door cord RH
R15	8	*	B-3	R57	Fuel tank cord
R16	1	Brown	A-3		Rear door switch RH
R30	2	Black	B-2		Diode (Rear gate latch switch)
R46	2	*	B-3	R67	Fuel tank cord
R50	2	Green	B-2	B90	Bulkhead wiring harness
R52	2	*	A-3		Room light
R57	8	*	B-3	R15	Rear wiring harness
R58	6	*	A-3		Fuel gauge module & fuel pump
R59	2	*	B-4		Fuel gauge sub module
R67	2	*	B-3	R46	Rear wiring harness
R68	2	*	B-3		Pressure control solenoid valve
R69	2	*	A-3		Vent control solenoid valve

*: Non-colored

7. FLOOR WIRING HARNESS, DOOR CORD AND GROUND POINT

● LHD model

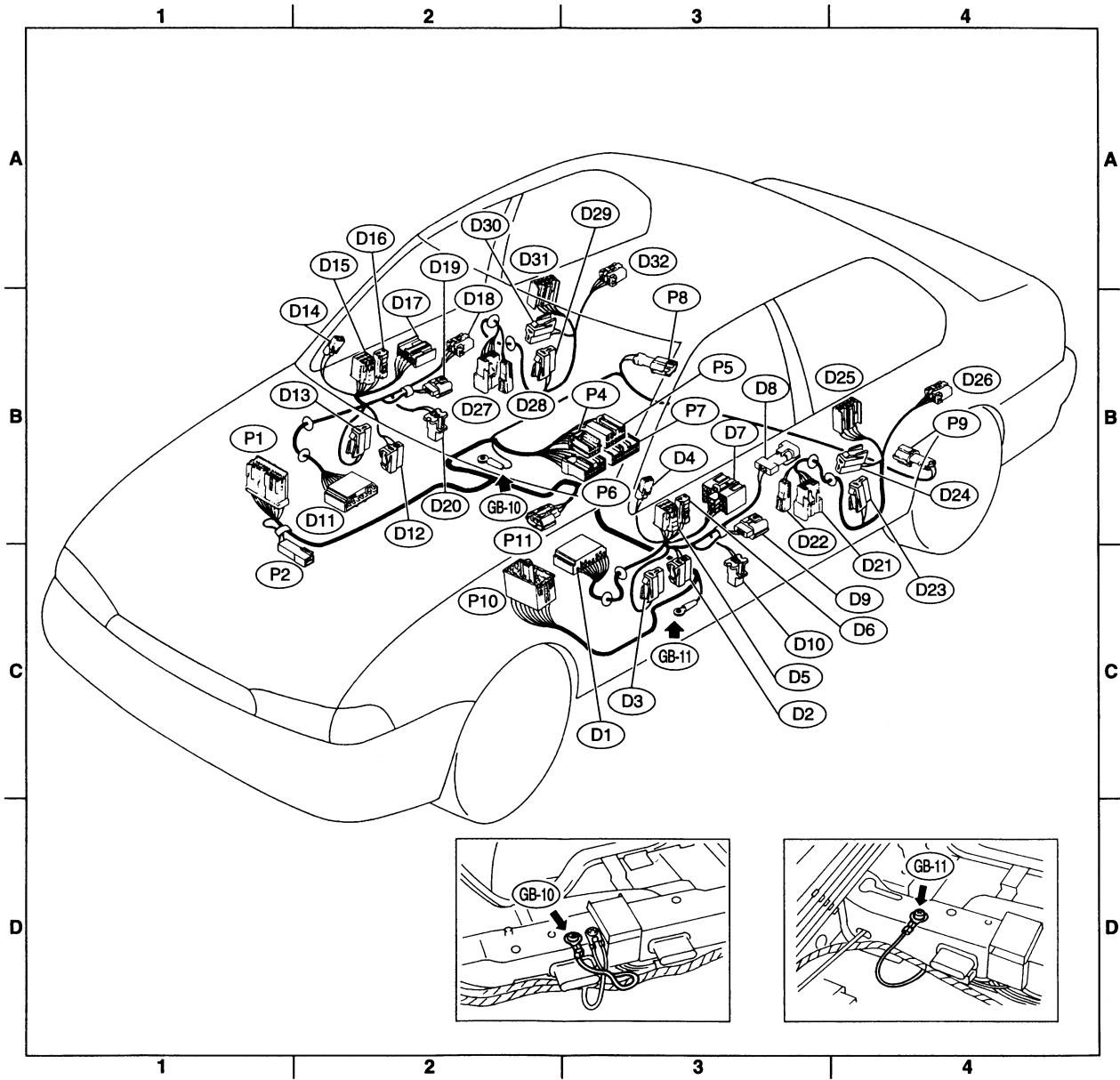

Connector				Connecting to	
No.	Pole	Color	Area	No.	Name
P1	20	Blue	B-1	F1	Front wiring harness (With TCS model)
	12	*	B-1	F1	Front wiring harness (With ABS model)
P2	2	Black	C-2		Diode (TCS)
P4	6	*	B-3		ABS/TCS control module
P5	8	*	B-3		
P6	16	*	B-3		
P7	20	*	B-3		
P8	2	Gray	B-3		Rear ABS sensor RH
	2	*	B-3		Rear ABS sensor RH (Outback with step roof)
P9	2	Gray	B-4		Rear ABS sensor LH
	2	*	B-4		Rear ABS sensor LH (Outback with step roof)
P10	40	Gray	B-2	B63	Bulkhead wiring harness (With TCS model)
P11	3	*	B-2		ABS G sensor

Connector				Connecting to	
No.	Pole	Color	Area	No.	Name
D1	24	*	C-3	B30	Bulkhead wiring harness
D2	2	*	C-3		Front door speaker LH
D3	2	Green	C-3		Front power window motor LH
D4	2	Black	B-3		Front tweeter LH
D5	6	*	B-3		Remote control rearview mirror LH
D6	2	*	B-3		Mirror heater LH
D7	14	*	B-3		Power window main switch
D8	2	Gray	B-3		Front door lock switch LH
	4	Gray	B-3		Front door lock switch LH (With security system)
D9	4	Gray	B-3		Front door key switch LH (Security)
D10	2	Black	C-3		Step light LH
D11	24	*	B-2	B101	Bulkhead wiring harness
D12	2	*	B-2		Front door speaker RH
D13	2	Green	B-2		Front power window motor RH
D14	2	Black	B-2		Front tweeter RH
D15	6	*	B-2		Remote control rearview mirror RH
D16	2	*	B-2		Mirror heater RH
D17	5	*	B-2		Front power window sub switch RH
D18	4	*	B-2		Front door lock actuator RH
	4	Gray	B-2		Front door lock actuator RH (With security system)
D19	4	Gray	B-2		Front door key switch RH (Security)
D20	2	Black	B-2		Step light RH
D21	8	*	B-3	R11	Rear wiring harness
D22	2	*	B-3	R10	Rear wiring harness (Security)
D23	2	Black	B-4		Rear door speaker LH
D24	2	Green	B-4		Rear power window motor LH
D25	5	*	B-4		Rear power window sub switch LH
D26	4	*	B-4		Rear door lock actuator LH
	4	Gray	B-4		Rear door lock actuator LH (With security system)
D27	8	*	B-2	R14	Rear wiring harness
D28	2	*	B-2	R13	Rear wiring harness (Security)
D29	2	Black	B-2		Rear door speaker RH
D30	2	Green	B-3		Rear power window motor RH
D31	5	*	A-2		Rear power window sub switch RH
D32	4	*	A-3		Rear door lock actuator RH
	4	Gray	A-3		Rear door lock actuator RH (With security system)

*: Non-colored

7. FLOOR WIRING HARNESS, DOOR CORD AND GROUND POINT

- RHD model

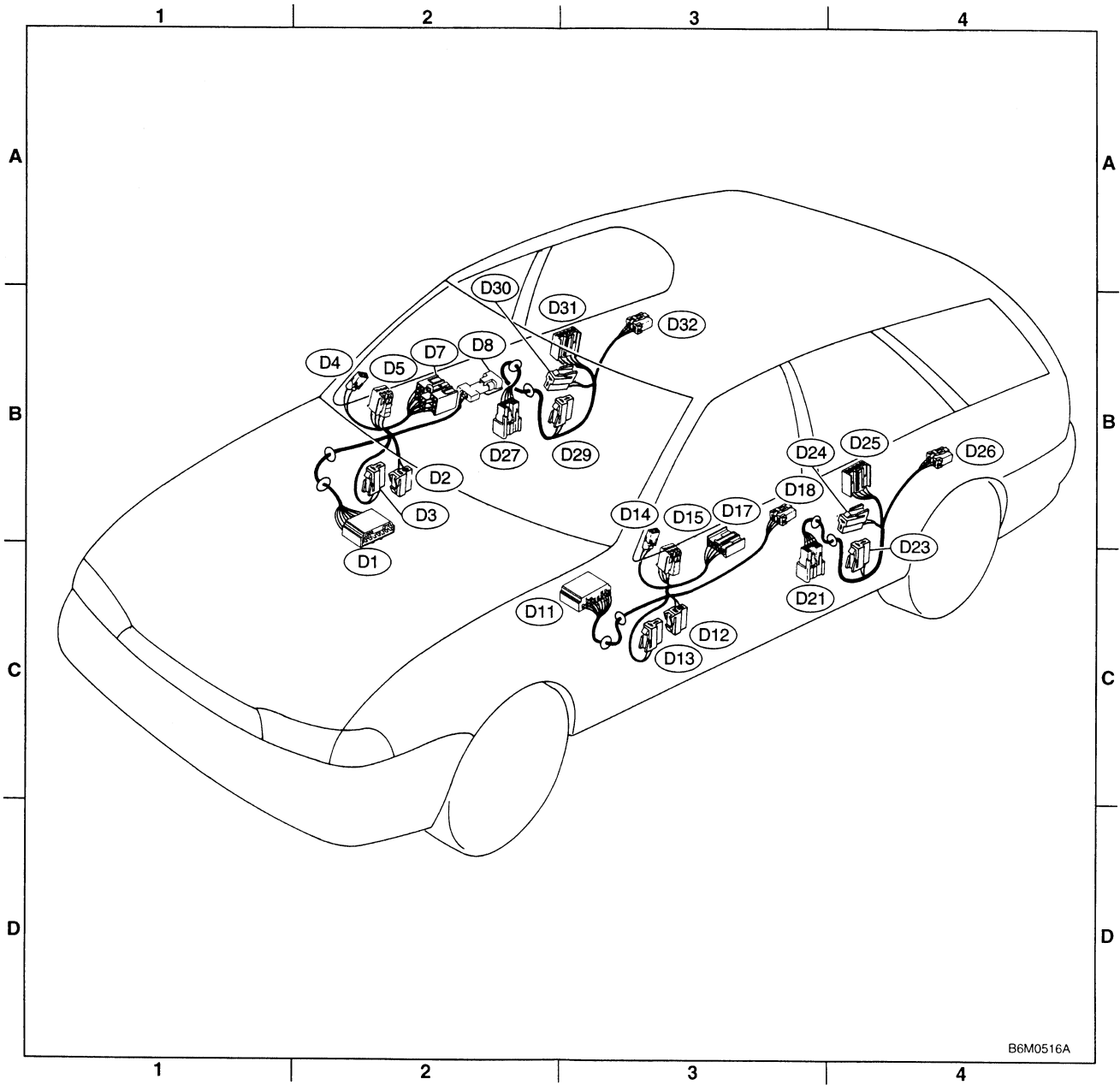

Connector				Connecting to	
No.	Pole	Color	Area	No.	Name
D1	24	*	B-2	B30	Bulkhead wiring harness
D2	2	*	B-2		Front door speaker RH
D3	2	Green	B-2		Front power window motor RH
D4	2	Black	A-2		Front tweeter RH
D5	6	*	B-2		Remote control rearview mirror RH
D7	14	*	B-2		Power window main switch
D8	2	Gray	A-2		Front door lock switch RH
D11	24	*	B-3	B101	Bulkhead wiring harness
D12	2	*	B-3		Front door speaker LH
D13	2	Green	B-3		Front power window motor LH
D14	2	Black	B-3		Front tweeter LH
D15	6	*	B-3		Remote control rearview mirror LH
D17	5	*	B-3		Front power window sub switch LH
D18	4	*	B-3		Front door lock actuator LH
D21	8	*	B-3	R11	Rear wiring harness
D23	2	Black	B-4		Rear door speaker LH
D24	2	Green	B-4		Rear power window motor LH
D25	5	*	B-4		Rear power window sub switch LH
D26	4	*	B-4		Rear door lock actuator LH
D27	8	*	B-2	R14	Rear wiring harness
D29	2	Black	B-3		Rear door speaker RH
D30	2	Green	A-3		Rear power window motor RH
D31	5	*	A-3		Rear power window sub switch RH
D32	4	*	A-3		Rear door lock actuator RH

*: Non-colored

8. REAR END WIRING HARNESS AND GROUND POINT OF SEDAN

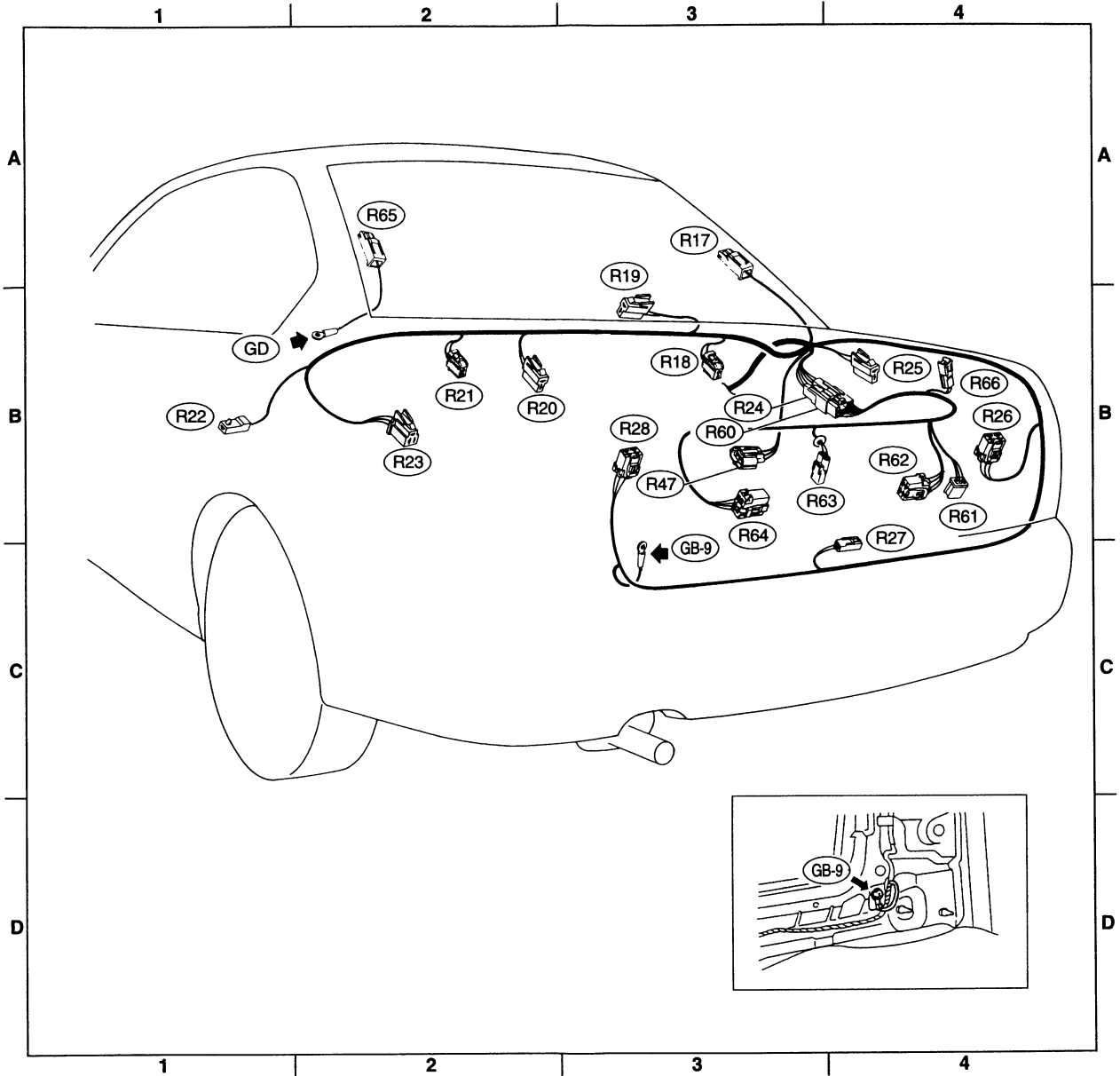

EPA0096

Connector				Connecting to	
No.	Pole	Color	Area	No.	Name
R17	1	Black	A-3		Rear defogger (Power)
R18	2	Black	B-3		Rear speaker RH
R19	2	*	B-3		High-mounted stop light
R20	2	Blue	B-2		Trunk room light
R21	2	Black	B-2		Rear speaker LH
R22	1	Brown	B-1		Rear door switch LH
R23	3	*	B-2		Power antenna
R24	6	*	B-3	R60	Trunk lid cord (Without security system)
	8	*	B-3	R60	Trunk lid cord (With security system)
R25	2	Black	B-4		Rear defogger condenser
R26	4	*	B-4		Rear combination light RH
R27	2	*	B-4		Trunk room light switch
R28	4	*	B-3		Rear combination light LH
R47	3	*	B-3		Fuel tank pressure sensor
R60	6	*	B-4	R24	Rear wiring harness (Without security system)
	8	*	B-4	R24	Rear wiring harness (With security system)
R61	3	*	B-4		Key switch (Security)
R62	4	*	B-4		Rear finisher light RH
R63	2	*	B-3		License plate light
R64	4	*	B-3		Rear finisher light LH
R65	1	Black	A-2		Rear defogger (Ground)
R66	2	Black	B-4		High-mounted stop light (Rear spoiler)

*: Non-colored

9. REAR END WIRING HARNESS AND GROUND POINT OF WAGON

- LHD model

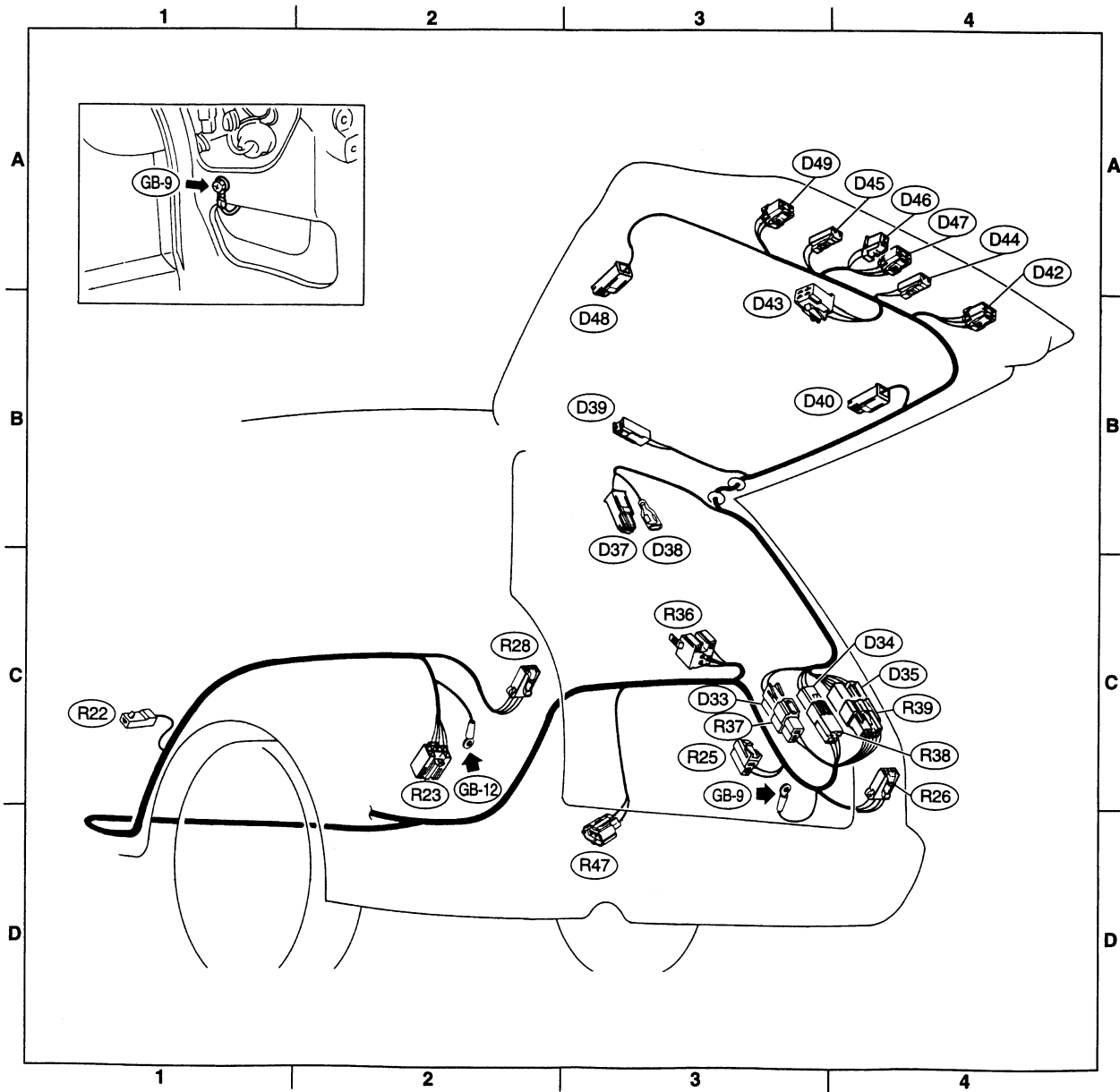

EPA0093

Connector				Connecting to	
No.	Pole	Color	Area	No.	Name
R22	1	Brown	C-1		Rear door switch LH
R23	6	*	C-2		Power antenna
R25	2	Black	C-3		Rear defogger condenser
R26	4	Black	D-4		Rear combination light RH
R28	4	Black	C-2		Rear combination light LH
R32	1	*	C-2		Rear accessory power supply (Power)
R33	1	Black	C-2		Rear accessory power supply (Ground)
R36	5	Black	C-3		Rear wiper relay
R37	2	*	C-3	D33	Rear gate cord
R38	4	*	C-3	D34	
R39	8	*	C-4	D35	
R40	4	Black	C-3	D36	Rear gate cord (With security)
R45	6	*	C-2		Trailer connector (Outback with step roof)
R47	3	*	D-3		Fuel tank pressure sensor

Connector				Connecting to	
No.	Pole	Color	Area	No.	Name
D33	2	*	C-3	R37	Rear wiring harness
D34	4	*	C-3	R38	
D35	8	*	C-4	R39	
D36	4	Black	C-3	R40	Rear wiring harness (With security)
D37	1	Black	B-3		Luggage room light
D38	1	*	B-3		
D39	2	*	B-3		High-mounted stop light
D40	1	Black	B-4		Rear defogger (Power)
D41	4	Gray	B-4		Key switch (Security)
D42	4	*	B-4		Rear finisher light RH
D43	4	*	B-3		Rear wiper motor
D44	2	*	B-4		License plate light RH
D45	2	*	A-3		License plate light LH
D46	2	Black	A-4		Rear gate latch switch
D47	4	*	A-4		Rear gate lock actuator (Without security system)
	4	Gray	A-4		Rear gate lock actuator (With security system)
D48	1	Black	B-3		Rear defogger (Ground)
D49	4	*	A-3		Rear finisher light LH

*: Non-colored

9. REAR END WIRING HARNESS AND GROUND POINT OF WAGON

● RHD model

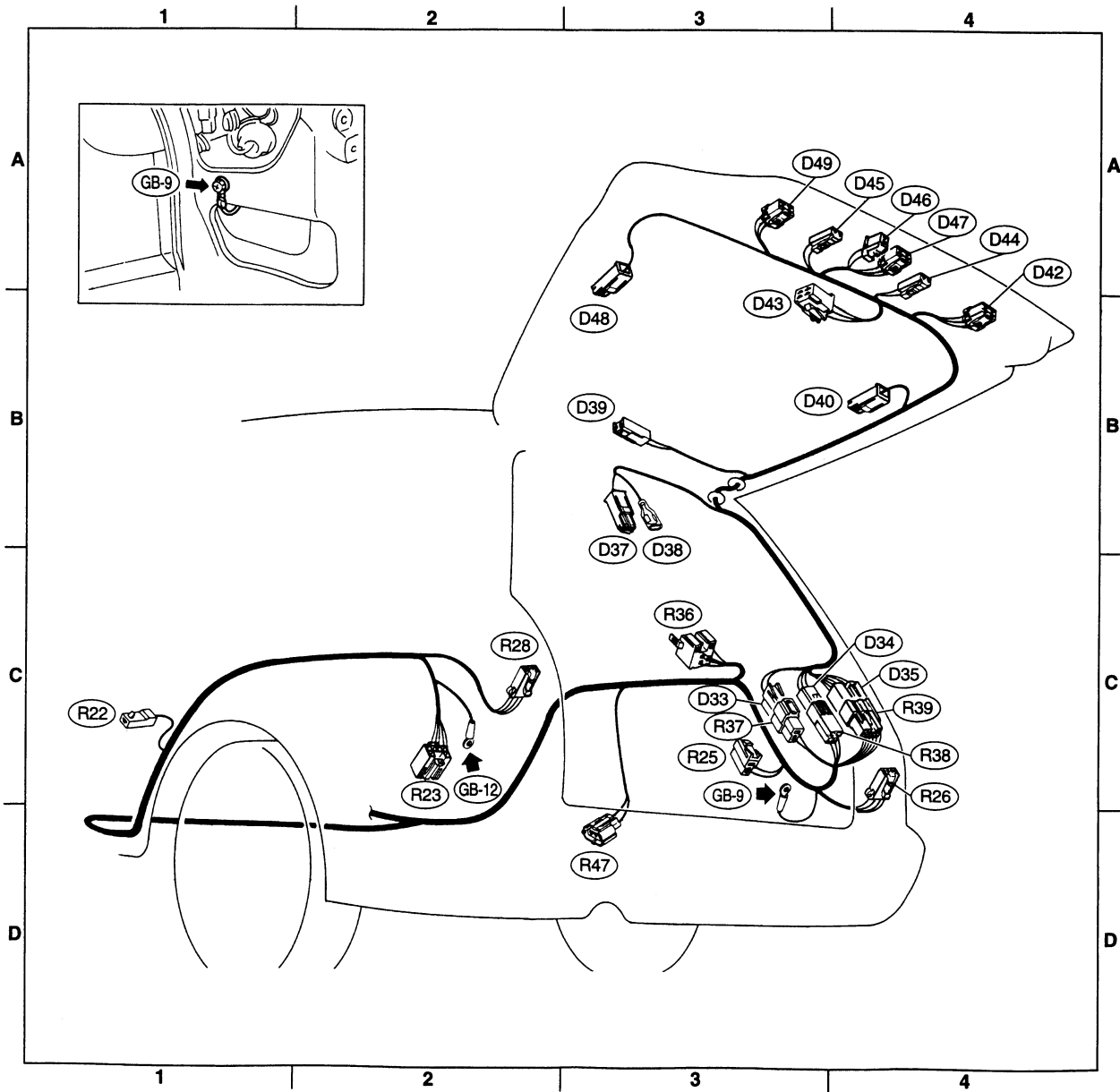

Connector				Connecting to	
No.	Pole	Color	Area	No.	Name
R22	1	Brown	C-1		Rear door switch LH
R23	6	*	C-2		Power antenna
R25	2	Black	C-3		Rear defogger condenser
R26	4	Black	D-4		Rear combination light RH
R28	4	Black	C-2		Rear combination light LH
R36	5	Black	C-3		Rear wiper relay
R37	2	*	C-3	D33	Rear gate cord
R38	4	*	C-3	D34	
R39	8	*	C-4	D35	
R47	3	*	D-3		Fuel tank pressure sensor

Connector				Connecting to	
No.	Pole	Color	Area	No.	Name
D33	2	*	C-3	R37	Rear wiring harness
D34	4	*	C-3	R38	
D35	8	*	C-4	R39	
D37	1	Black	B-3		Luggage room light
D38	1	*	B-3		High-mounted stop light
D39	2	*	B-3		Rear defogger (Power)
D40	1	Black	B-4		Rear defogger (Power)
D42	4	*	B-4		Rear finisher light RH
D43	4	*	B-3		Rear wiper motor
D44	2	*	B-4		License plate light RH
D45	2	*	A-3		License plate light LH
D46	2	Black	A-4		Rear gate latch switch
D47	4	*	A-4		Rear gate lock actuator
D48	1	Black	B-3		Rear defogger (Ground)
D49	4	*	A-3		Rear finisher light LH

*: Non-colored