

3. Airbag Module

CAUTION:

- The airbag module (driver side and passenger side) must not be disassembled. The airbag module cannot be used again once inflated.

- When removing and installing the airbag module (driver side and passenger side), the operator should stand, as much as possible, on the side of the airbag module.

- After removal, the airbag module (driver side and passenger side) should be kept away from heat and light sources, and stored on a clean, flat surface to prevent from any damage to its lower structure.

- Do not check airbag module (driver side and passenger side) continuity with airbag removed from the vehicle body.

- Replace airbag module (driver side and passenger side) with a new one, should any of the following conditions develop.

- (1) Pad surface is scratched or cracked.
- (2) Connector harness is damaged.
- (3) Inflator side structure of module is cracked or deformed.
- (4) Module is excessively stained with water, oil, etc.
- (5) Module was accidentally dropped.

- When storing a removed airbag module (driver side and passenger side), be sure to place it in parallel with floor with the pad facing up. Do not place it against a wall, or place anything on the pad; otherwise, a dangerous condition may be created if the module malfunctions.

Driver side

GOOD

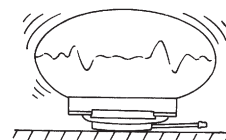
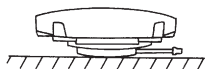

NO GOOD

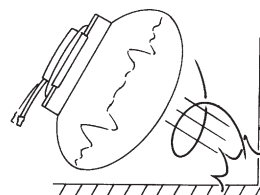
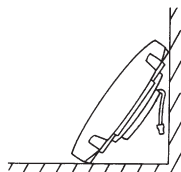

NO GOOD

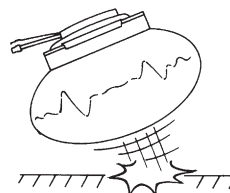
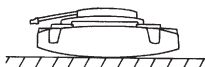

NO GOOD

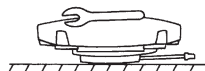

Passenger side

GOOD

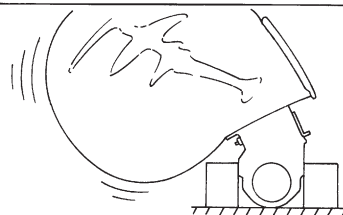
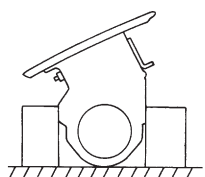

NO GOOD

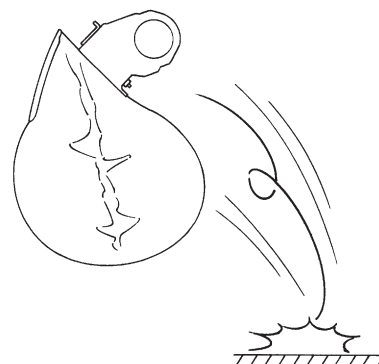
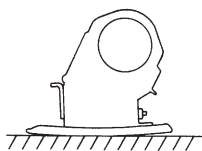

NO GOOD

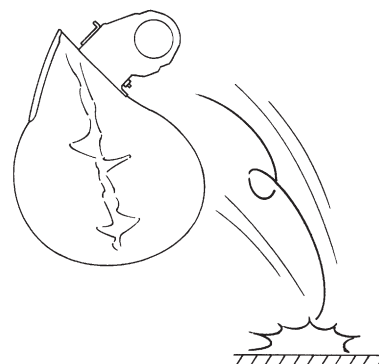
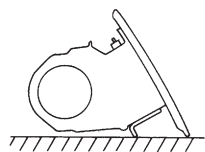

A: REMOVAL**1. DRIVER SIDE**

- 1) Set front wheels in straight ahead position.
- 2) Turn ignition switch off.
- 3) Disconnect ground cable from battery and wait for at least 20 seconds before starting work.

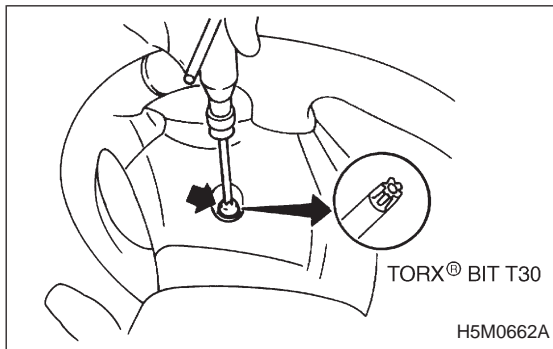

- 4) Using TORX® BIT T30, remove two TORX® bolts.

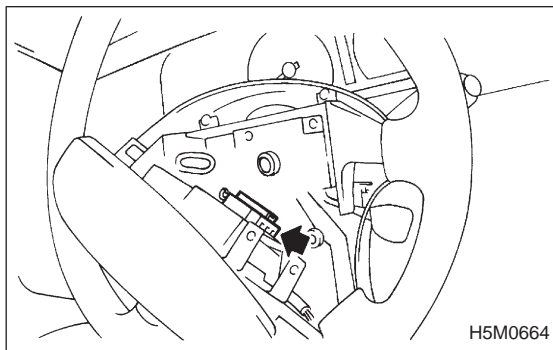

- 5) Disconnect airbag connector on back of airbag module. <Ref. to 5-5 [M2-6].>

- 6) Refer to “**CAUTION**” for handling of a removed airbag module. <Ref. to 5-5b [W300].>

2. PASSENGER SIDE

- 1) Remove instrument panel. <Ref. to 5-4 [W1A0].>

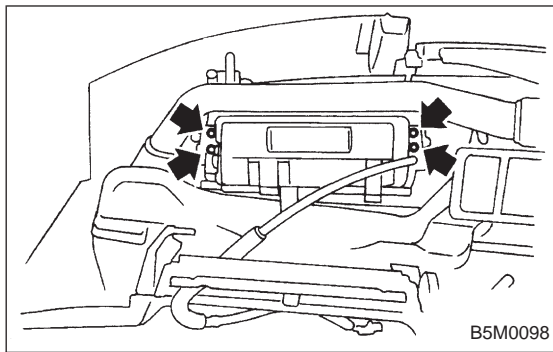

- 2) Remove four bolts and then carefully remove airbag module.
- 3) Refer to “CAUTION” for handling of a removed airbag module.

B: INSTALLATION

Installation is in reverse order of removal procedures. Observe the following: Make sure that ignition switch is off.

CAUTION:

Do not allow harness and connectors to interfere or get caught with other parts.

4. Main Harness

A: REMOVAL

- 1) Turn ignition switch off.
- 2) Disconnect ground cable from battery and wait for at least 20 seconds before starting work.

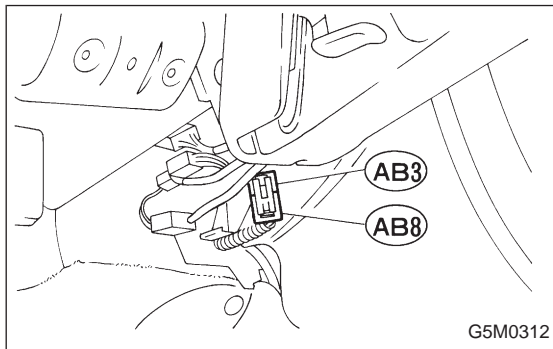

- 3) Remove lower cover. <Ref. to 5-4 [W1A0].> Disconnect airbag connector (AB3) and (AB8) below steering column.

CAUTION:

Do not reconnect airbag connector at steering column until main harness are securely re-installed.

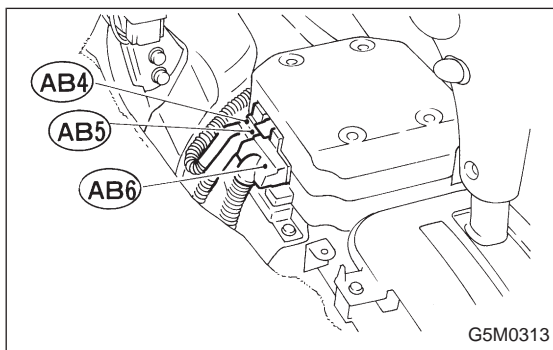

- 4) Remove console box. <Ref. to 5-4 [W1A0].> Disconnect 12-pin yellow connector (AB6) from airbag control module. <Ref. to 5-5 [M2-6].>