

7. Back-up Light

A: REMOVAL AND INSTALLATION

1. BACK-UP LIGHT

Refer to 6-2 [W5A2] as for removal and installation of rear finisher.

2. BACK-UP LIGHT SWITCH (MT MODEL)

Refer to 3-1 [W2B1 (AWD) or W3A0 (FWD)] as for removal and installation of back-up light switch.

3. INHIBITOR SWITCH (AT MODEL)

Refer to 3-2 [W4A4] as for removal and installation of inhibitor switch (R position switch).

B: INSPECTION

1. INHIBITOR SWITCH (AT MODEL)

Refer to 3-2 [W2B2] as for inspection of inhibitor switch.

8. Room Light and Door Switch

A: REMOVAL AND INSTALLATION

1. ROOM LIGHT

- 1) Pry room light lens off using a screwdriver.
- 2) Remove screws which secure room light body.
- 3) Remove room light body while disconnecting connector.

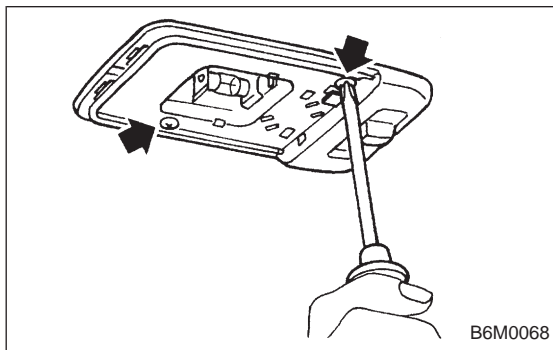

2. TRUNK ROOM LIGHT (SEDAN)

- 1) Turn trunk room light body by hand and remove it from rear shelf panel.
- 2) Disconnect connector of trunk room light.

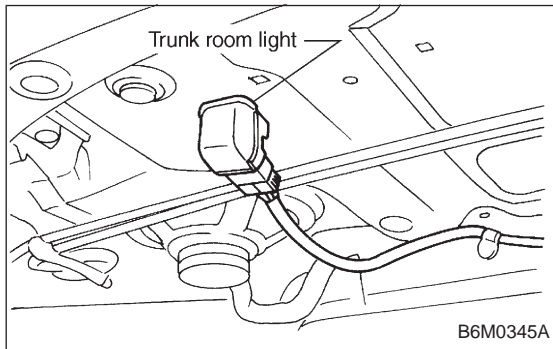

3. LUGGAGE ROOM LIGHT (WAGON)

- 1) Pry luggage room light lens off using a screwdriver.
- 2) Remove screws which secure luggage room light body.
- 3) Remove luggage room light body while disconnecting connector.

