

2. AT Shift Lock System

A: WIRING DIAGRAM

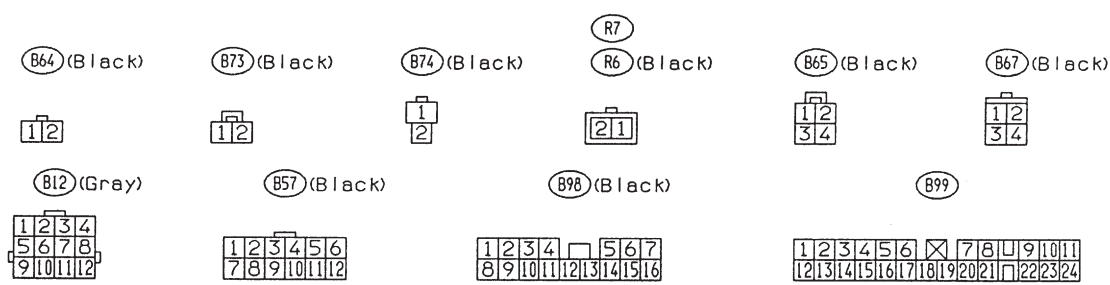

B: BASIC DIAGNOSTICS CHART

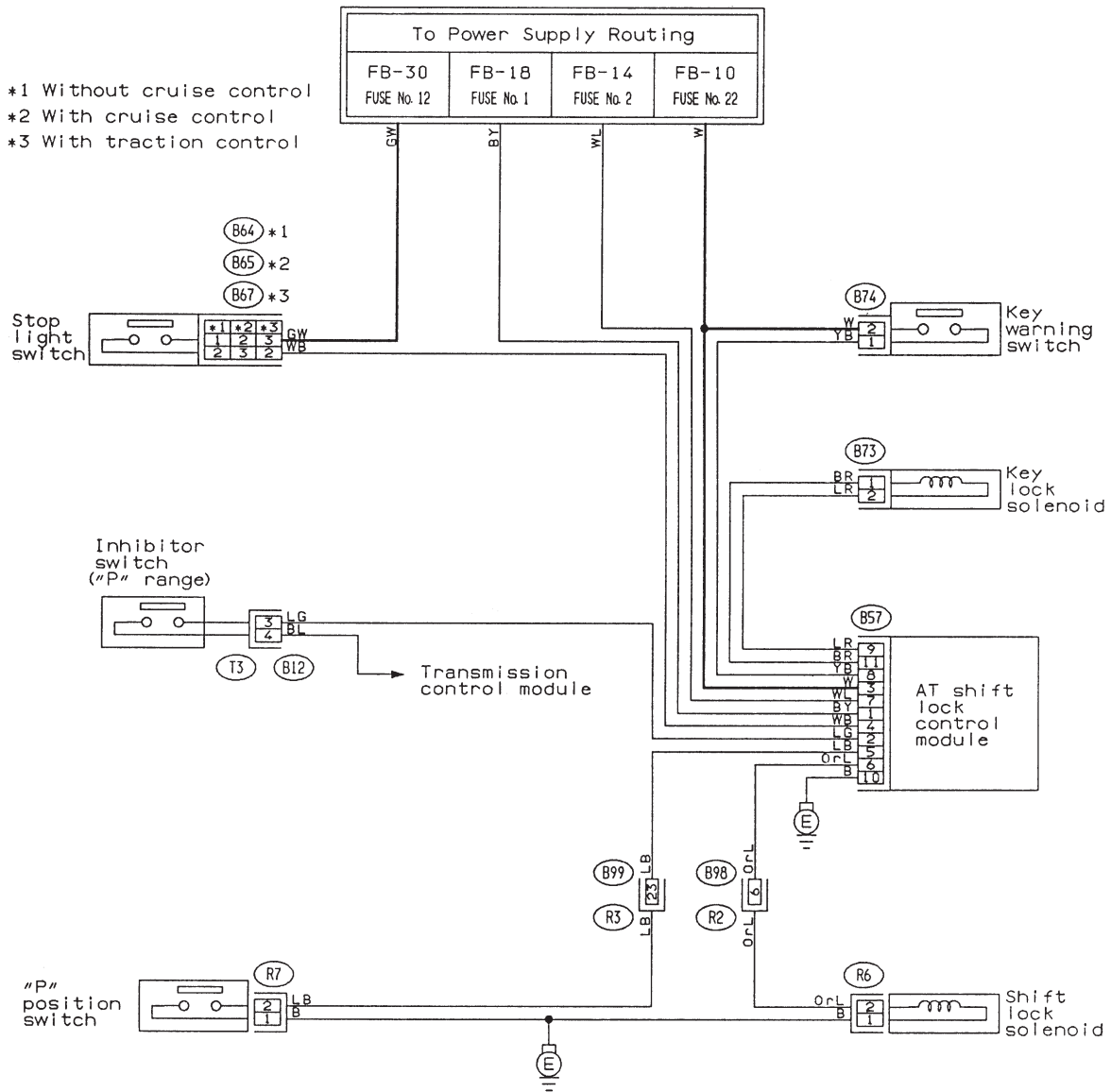
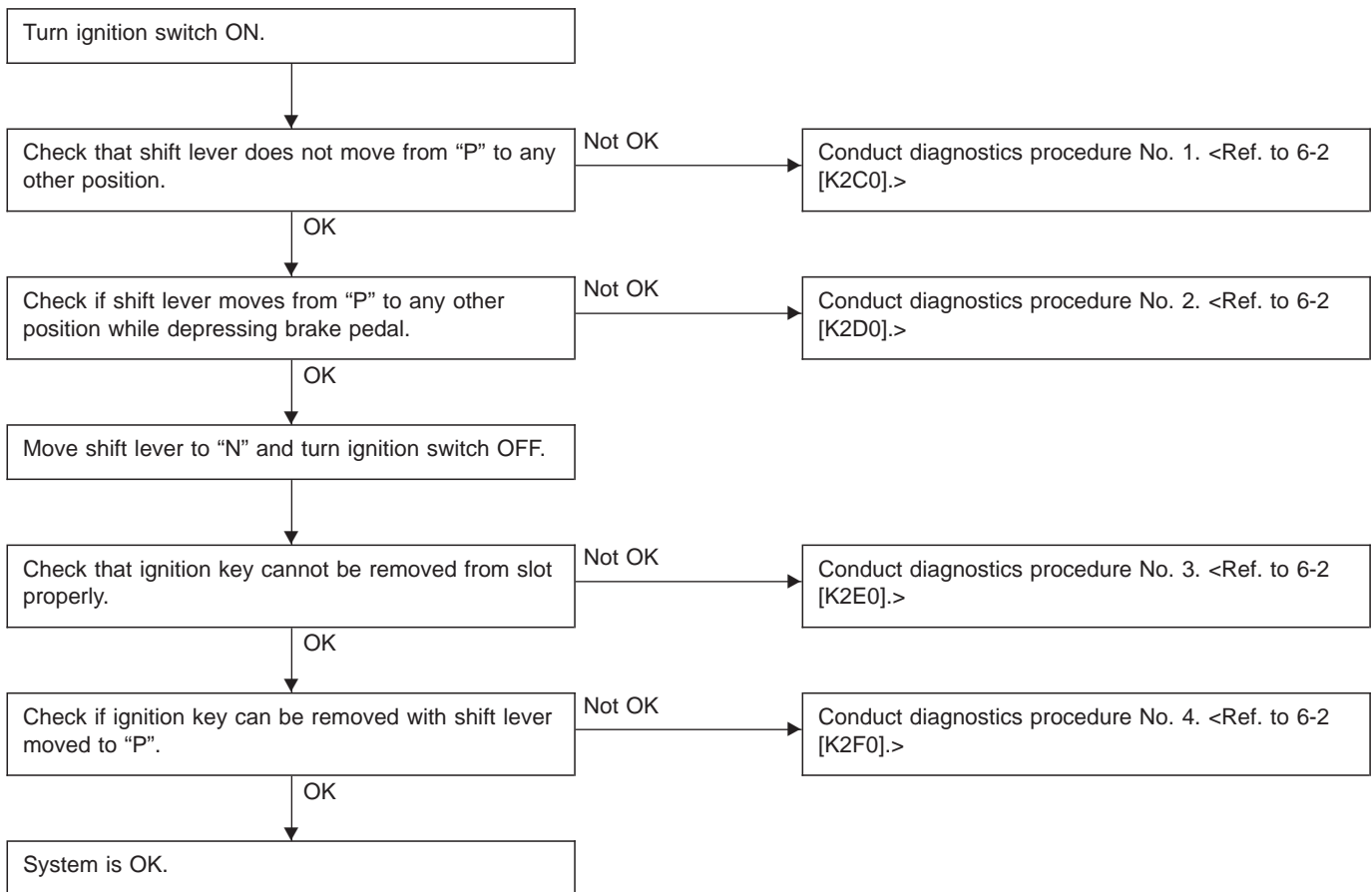

C: DIAGNOSTICS PROCEDURE No. 1

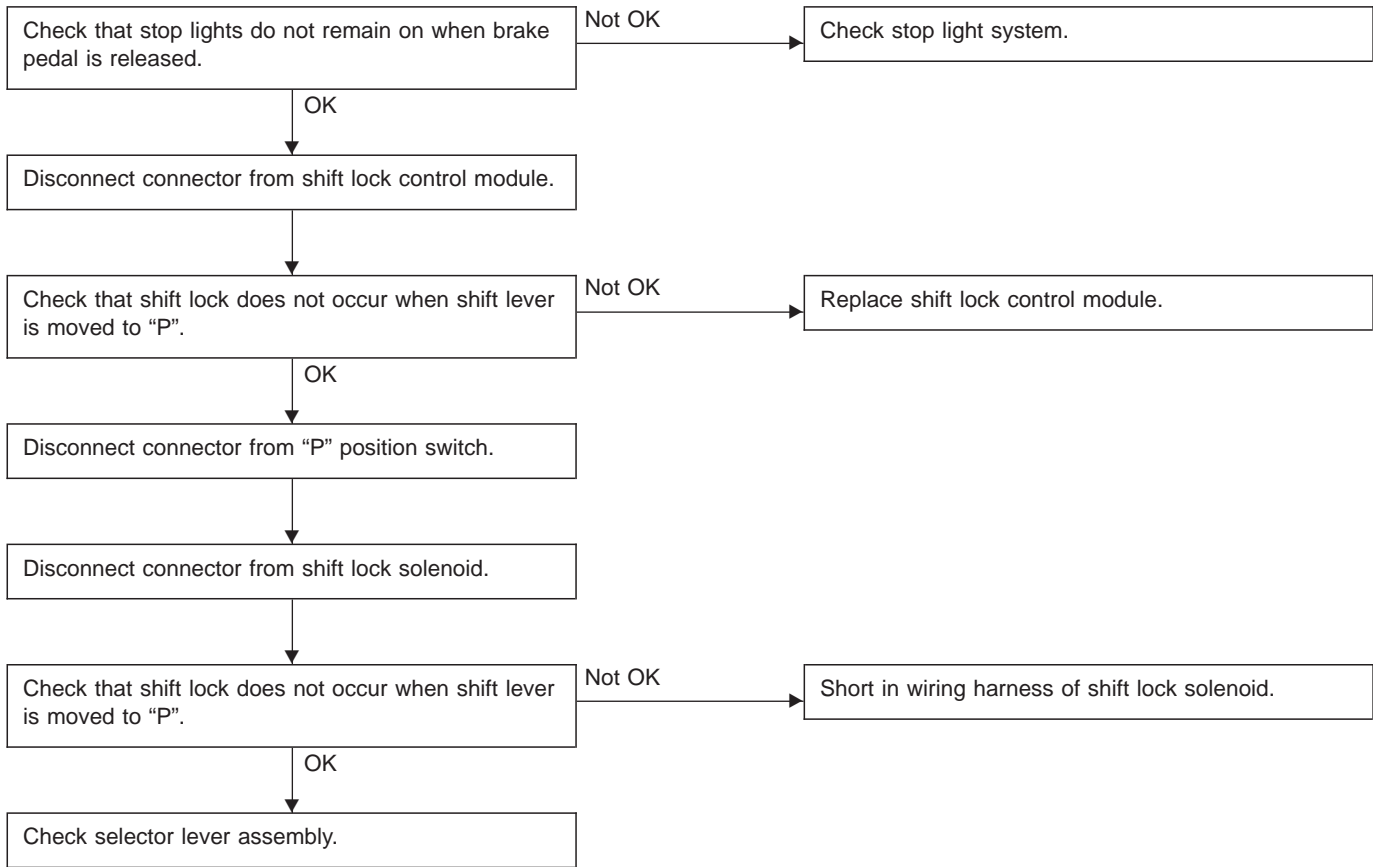

D: DIAGNOSTICS PROCEDURE No. 2 (SHIFT LOCK DOES NOT RELEASE.)

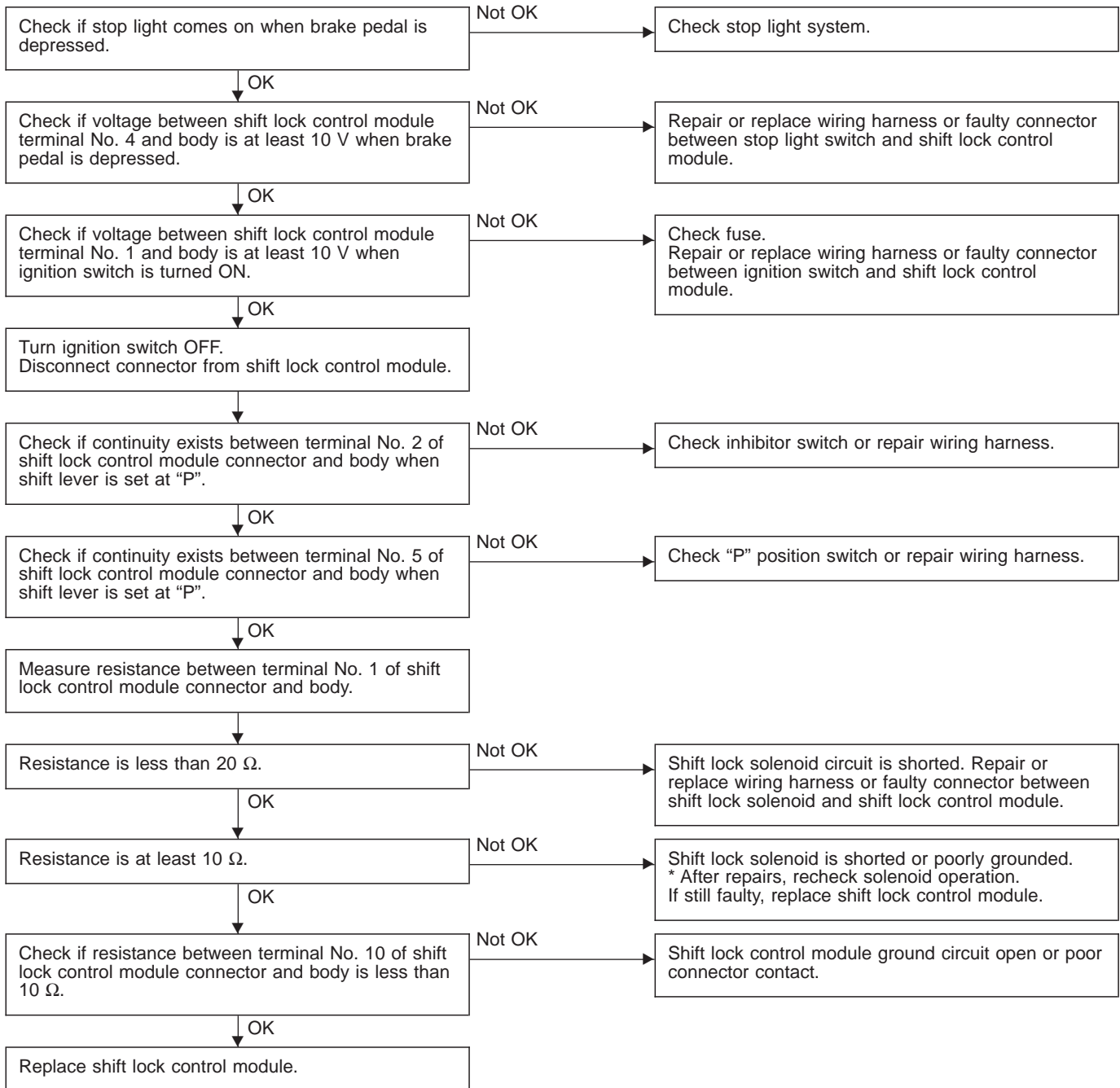

E: DIAGNOSTICS PROCEDURE No. 3 (KEY INTERLOCK DOES NOT OPERATE.)

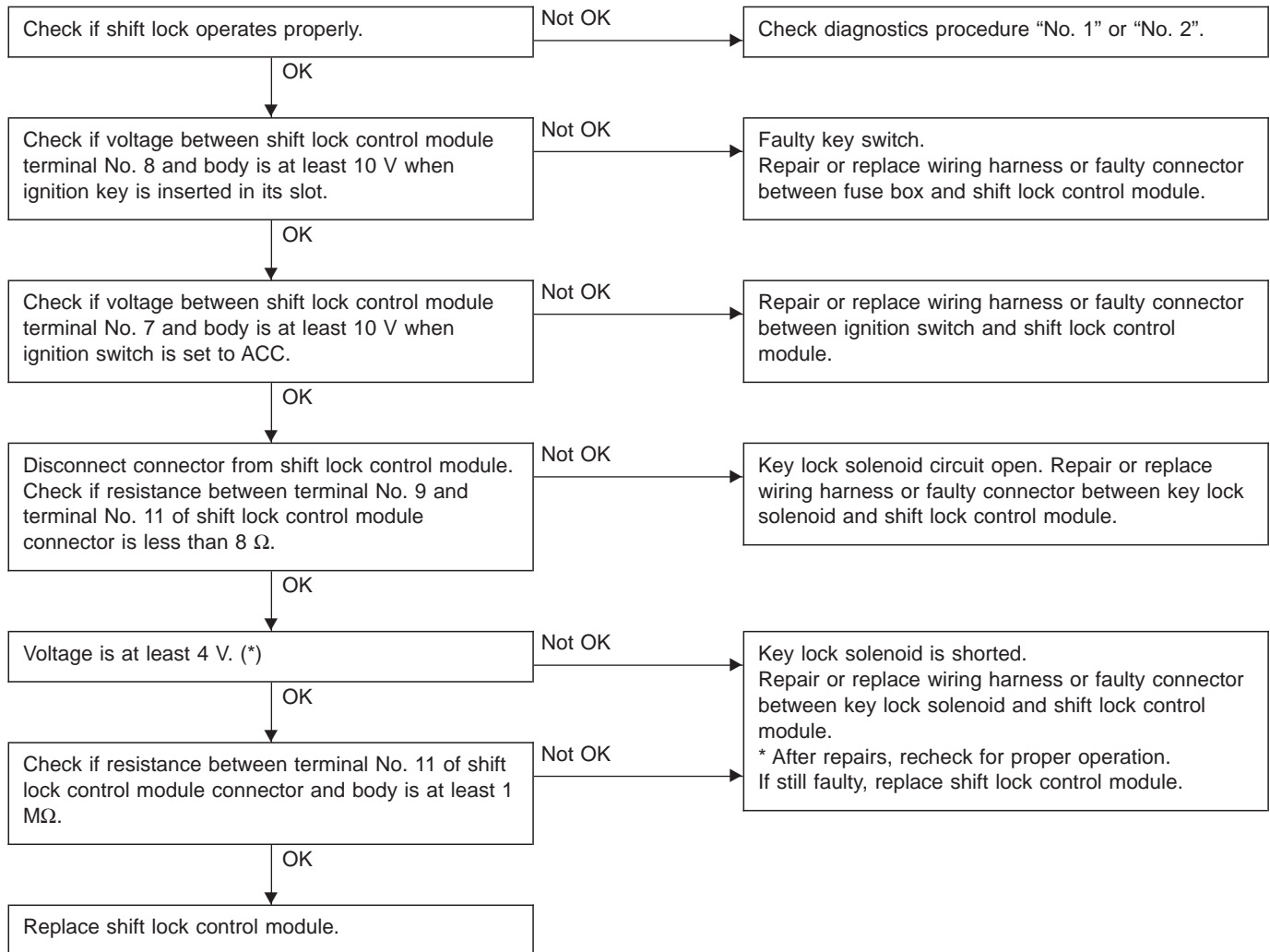

***: When conducting operational checks of the key lock solenoid, do not apply 12 V to solenoid for more than one second, since this may break solenoid circuit.**

F: DIAGNOSTICS PROCEDURE No. 4 (KEY INTERLOCK DOES NOT RELEASE.)

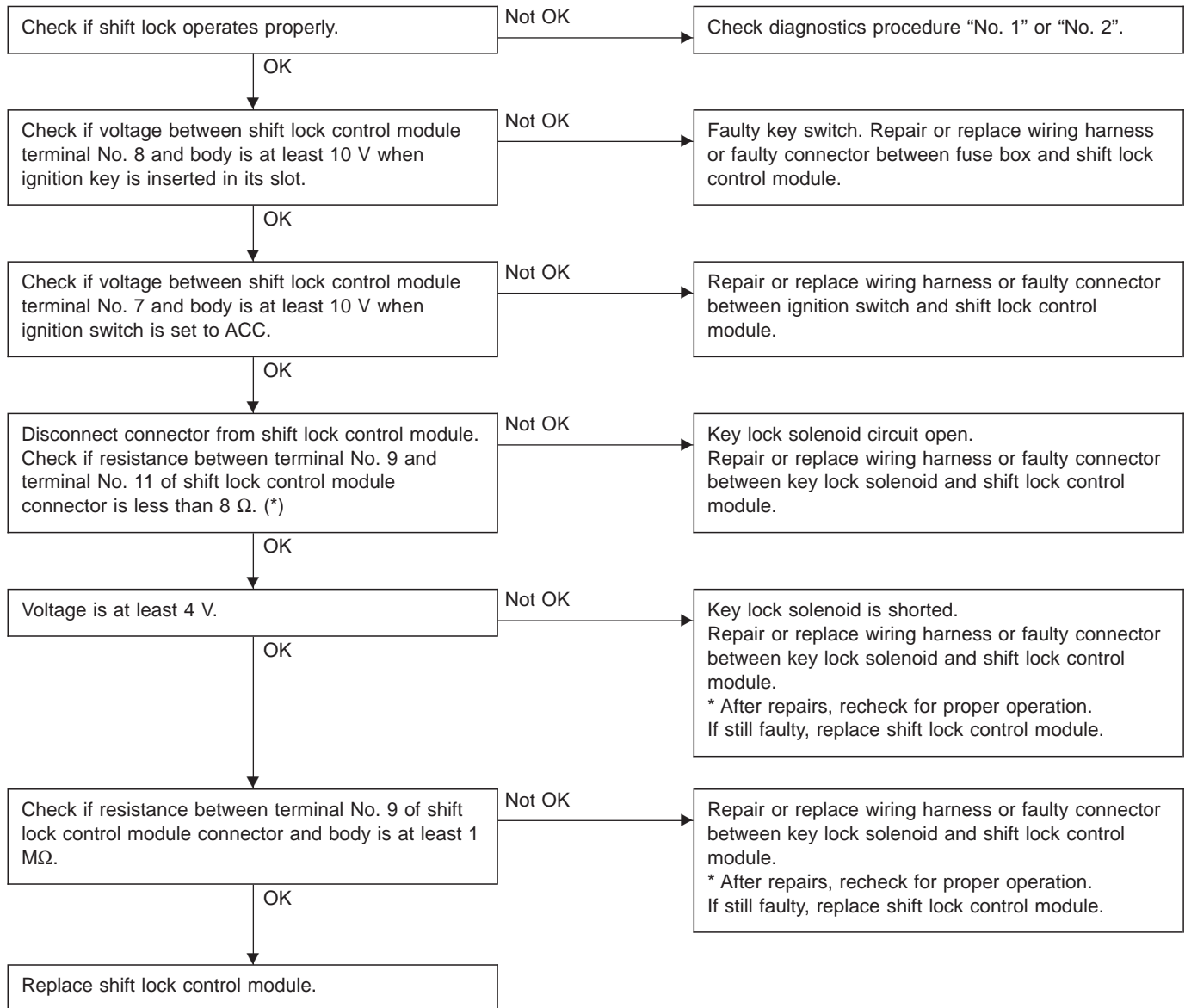

*: When conducting operational checks of the key lock solenoid, do not apply 12 V to solenoid for more than one second, since this may break solenoid circuit.