

G2M0223

5. Radiator Cap

A: INSPECTION

- 1) Attach radiator cap to tester.
- 2) Increase pressure until tester gauge pointer stops. Radiator cap is functioning properly if it holds the service limit pressure for five to six seconds.

Standard pressure:

78 — 98 kPa (0.8 — 1.0 kg/cm², 11 — 14 psi)

Service limit pressure:

69 kPa (0.7 kg/cm², 10 psi)

CAUTION:

Be sure to remove foreign matter and rust from the cap in advance; otherwise, results of pressure test will be incorrect.

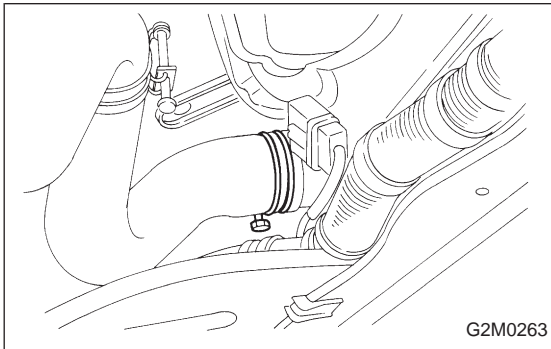

G2M0263

6. Radiator Fan and Fan Motor

A: REMOVAL

- 1) Disconnect ground cable from battery terminal.
- 2) Disconnect connector of fan motor.

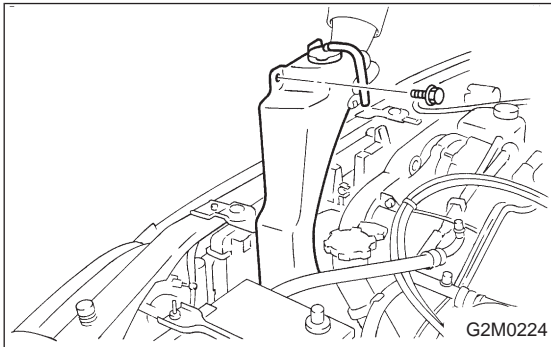

G2M0224

- 3) Remove reservoir tank.

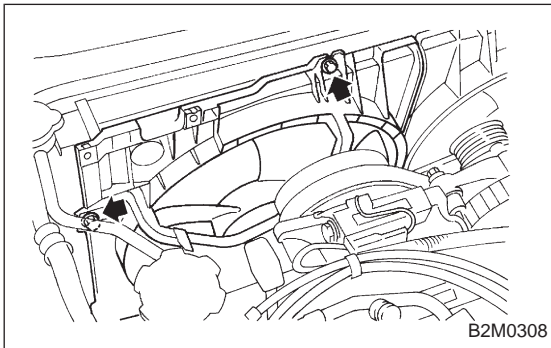

B2M0308

- 4) Remove four bolts holding shroud to radiator.

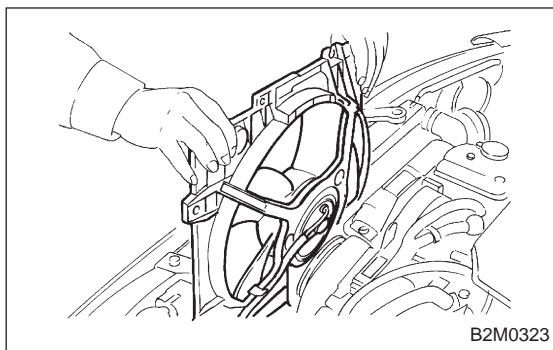

- 5) Remove radiator fan motor assembly.
- 6) Remove fan motor from shroud.

B: INSTALLATION

Installation is in the reverse order of removal procedures. Do the following:

- 1) Before installing radiator fan motor, apply a coat of sealant to threads and tighten nuts.
- 2) Make sure radiator fan does not come into contact with shroud when installed.
- 3) After installation, make sure there is no unusual noise or vibration when fan is rotated.

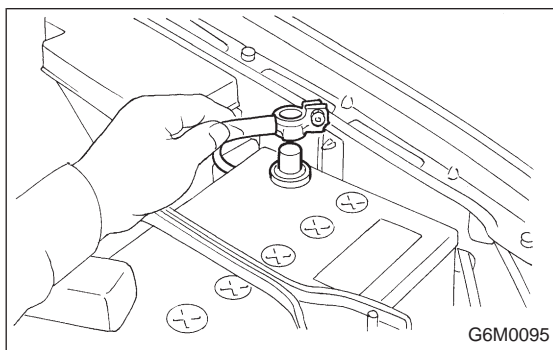

7. Engine Coolant Pipe

A: REMOVAL

- 1) Release fuel pressure.
<Ref. to 2-8 [W1A0].>
- 2) Disconnect ground cable from the battery.

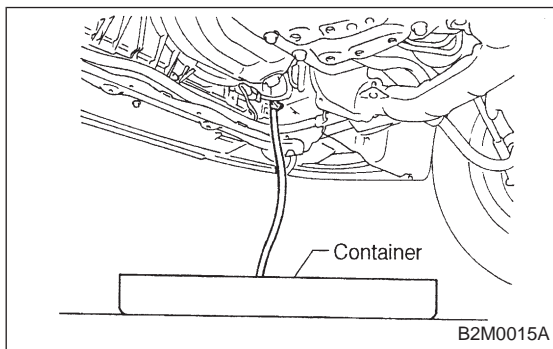

- 3) Drain engine coolant completely.
<Ref. to 2-5 [W1A0].>

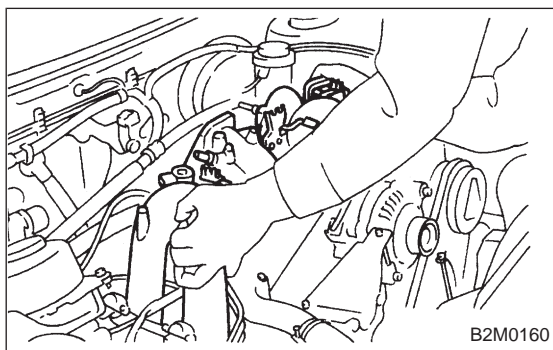

- 4) Remove intake manifold.
<Ref. to 2-7 [W4A0].>