

4. Cylinder Block

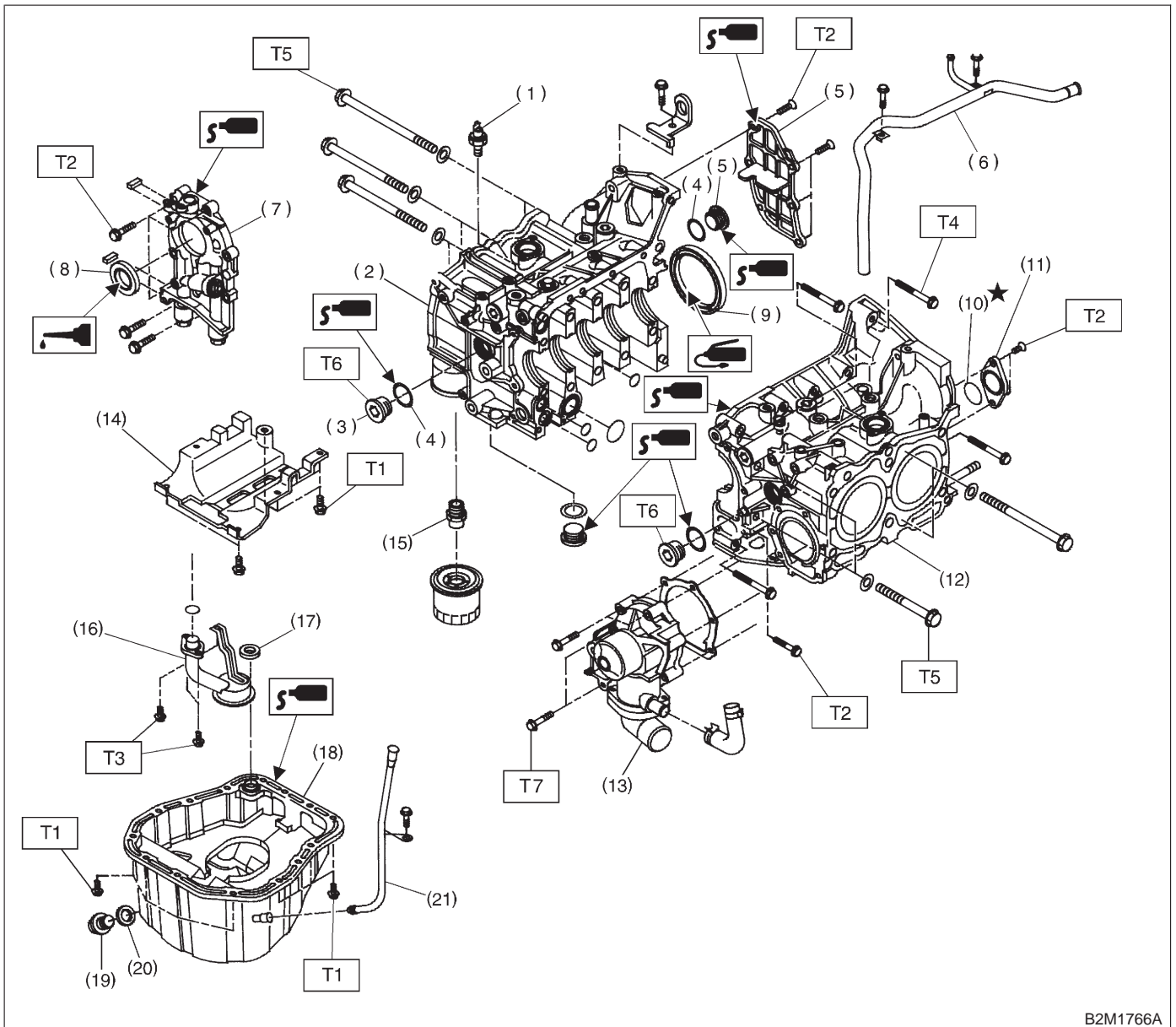

B2M1766A

- | | |
|-------------------------|----------------------------|
| (1) Oil pressure switch | (12) Cylinder block (LH) |
| (2) Cylinder block (RH) | (13) Water pump |
| (3) Service hole plug | (14) Baffle plate |
| (4) Gasket | (15) Oil filter connector |
| (5) Oil separator cover | (16) Oil strainer |
| (6) Water by-pass pipe | (17) Gasket |
| (7) Oil pump | (18) Oil pan |
| (8) Front oil seal | (19) Drain plug |
| (9) Rear oil seal | (20) Metal gasket |
| (10) O-ring | (21) Oil level gauge guide |
| (11) Service hole cover | |

Tightening torque: N-m (kg-m, ft-lb)

- T1: 5 (0.5, 3.6)**
T2: 6.4 (0.65, 4.7)
T3: 10 (1.0, 7)
T4: 25±2 (2.5±0.2, 18.1±1.4)
T5: 47±3 (4.8±0.3, 34.7±2.2)
T6: 69±7 (7.0±0.7, 50.6±5.1)
T7: First 12±2 (1.2±0.2, 8.7±1.4)
Second 12±2 (1.2±0.2, 8.7±1.4)