

2. AT Shift Lock System

A: WIRING DIAGRAM

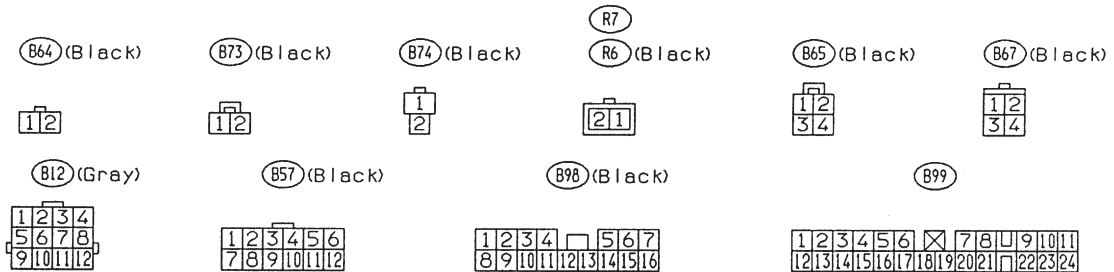
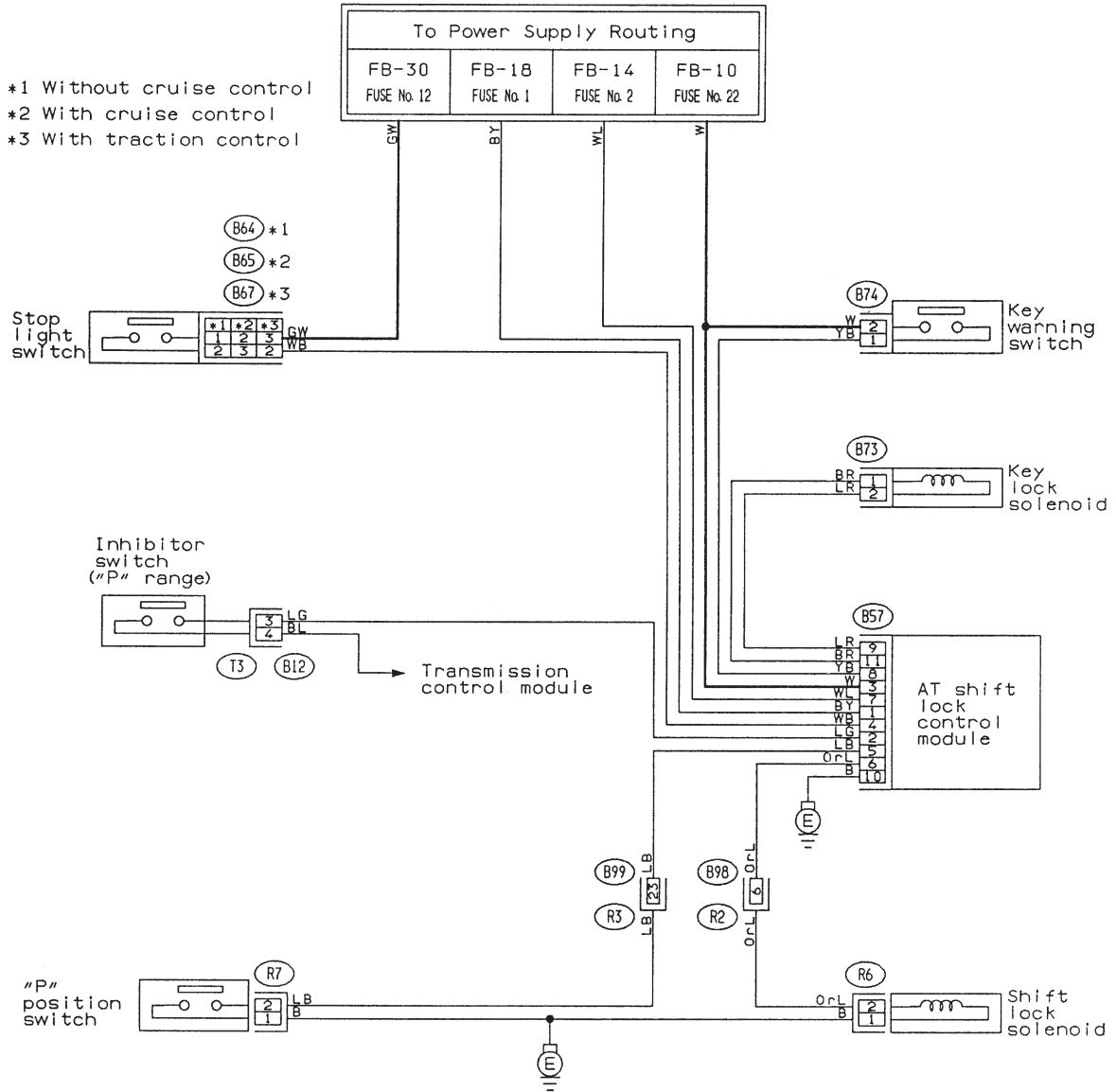

6-2b [T2B0] BODY ELECTRICAL SYSTEM (ELECTRICAL PARTS)

2. AT Shift Lock System

B: BASIC DIAGNOSTICS CHART

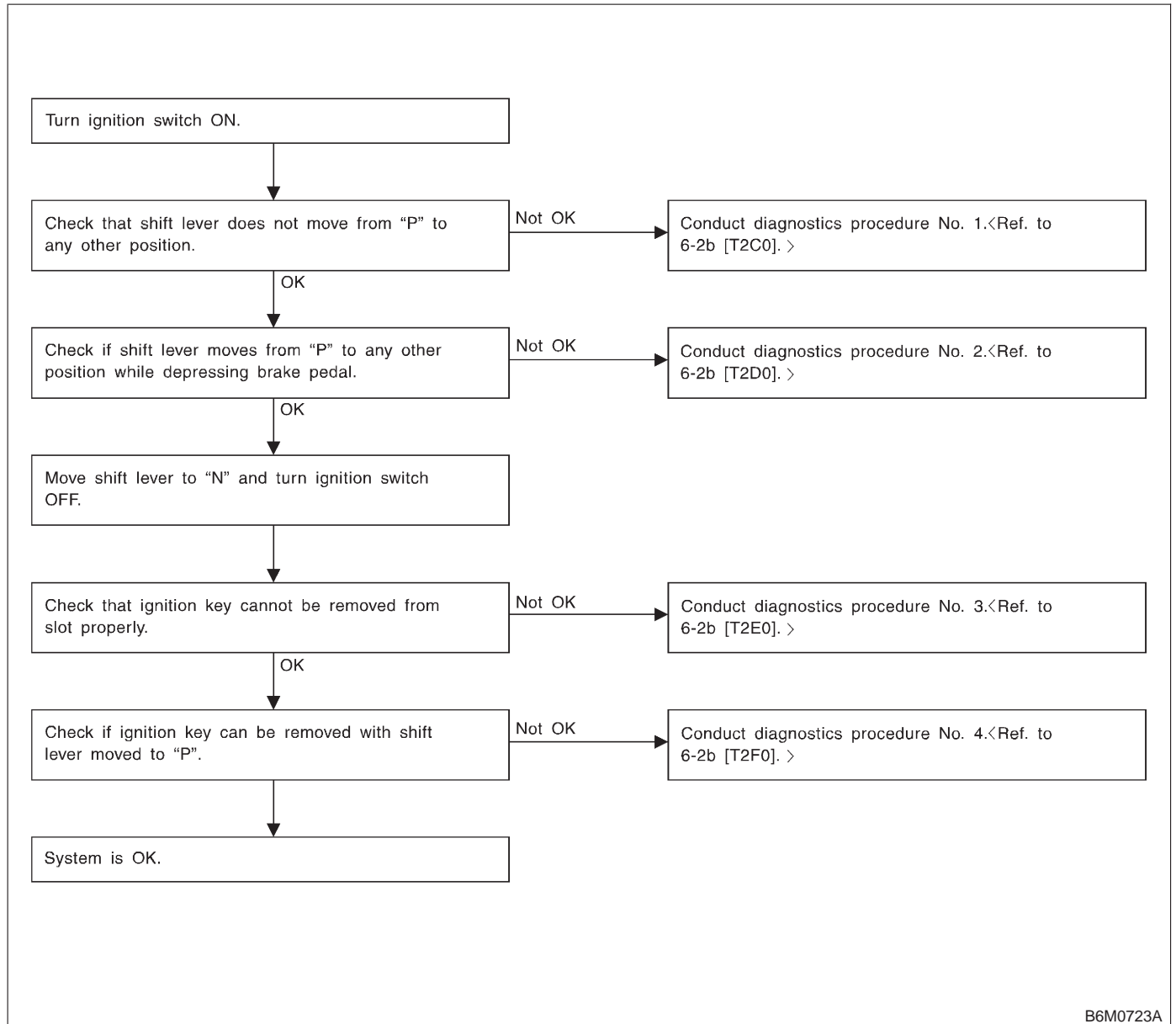

B6M0723A

C: DIAGNOSTICS PROCEDURE NO. 1

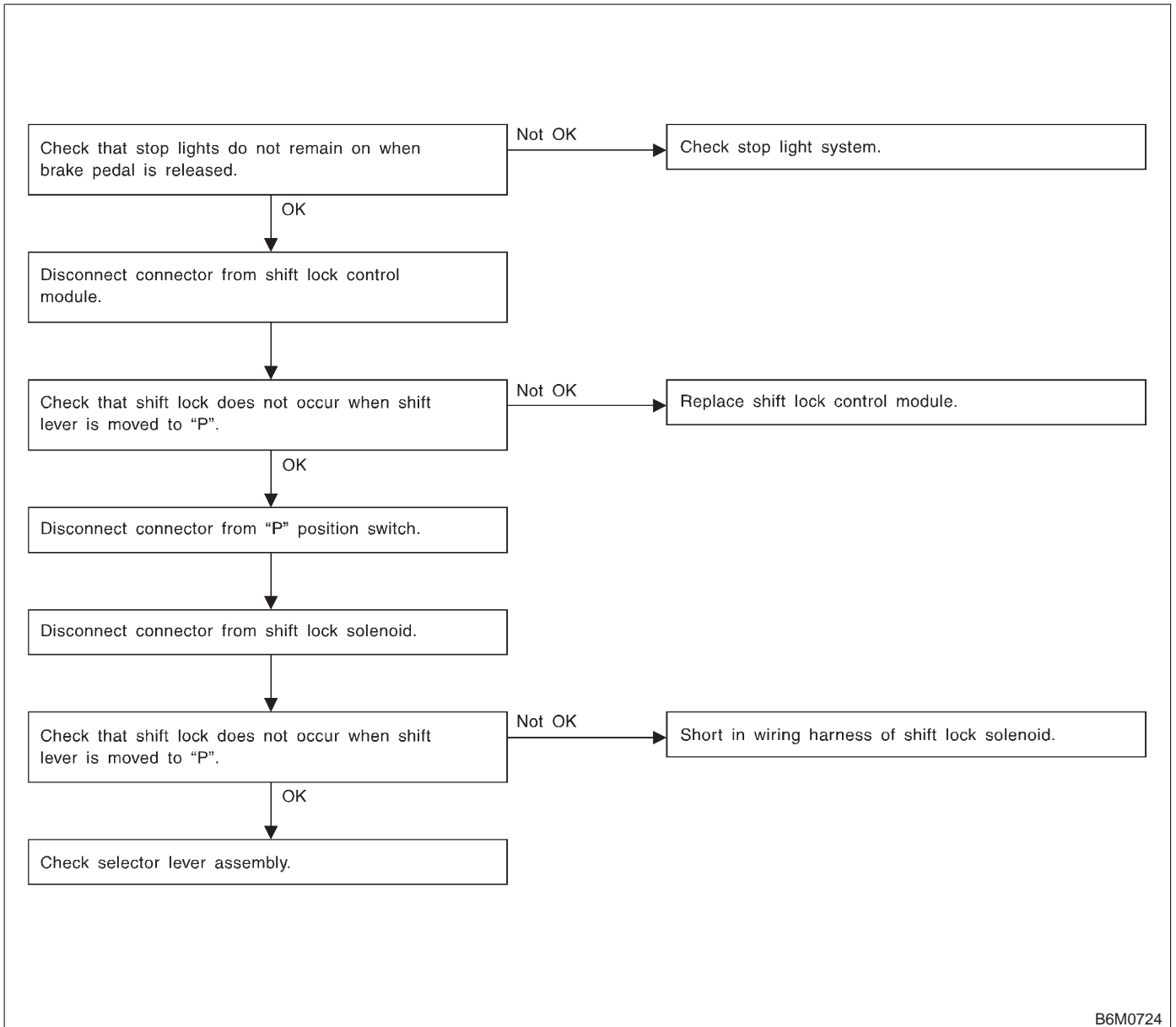

B6M0724

6-2b [T2D0] BODY ELECTRICAL SYSTEM (ELECTRICAL PARTS)

2. AT Shift Lock System

D: DIAGNOSTICS PROCEDURE NO. 2 (SHIFT LOCK DOES NOT RELEASE.)

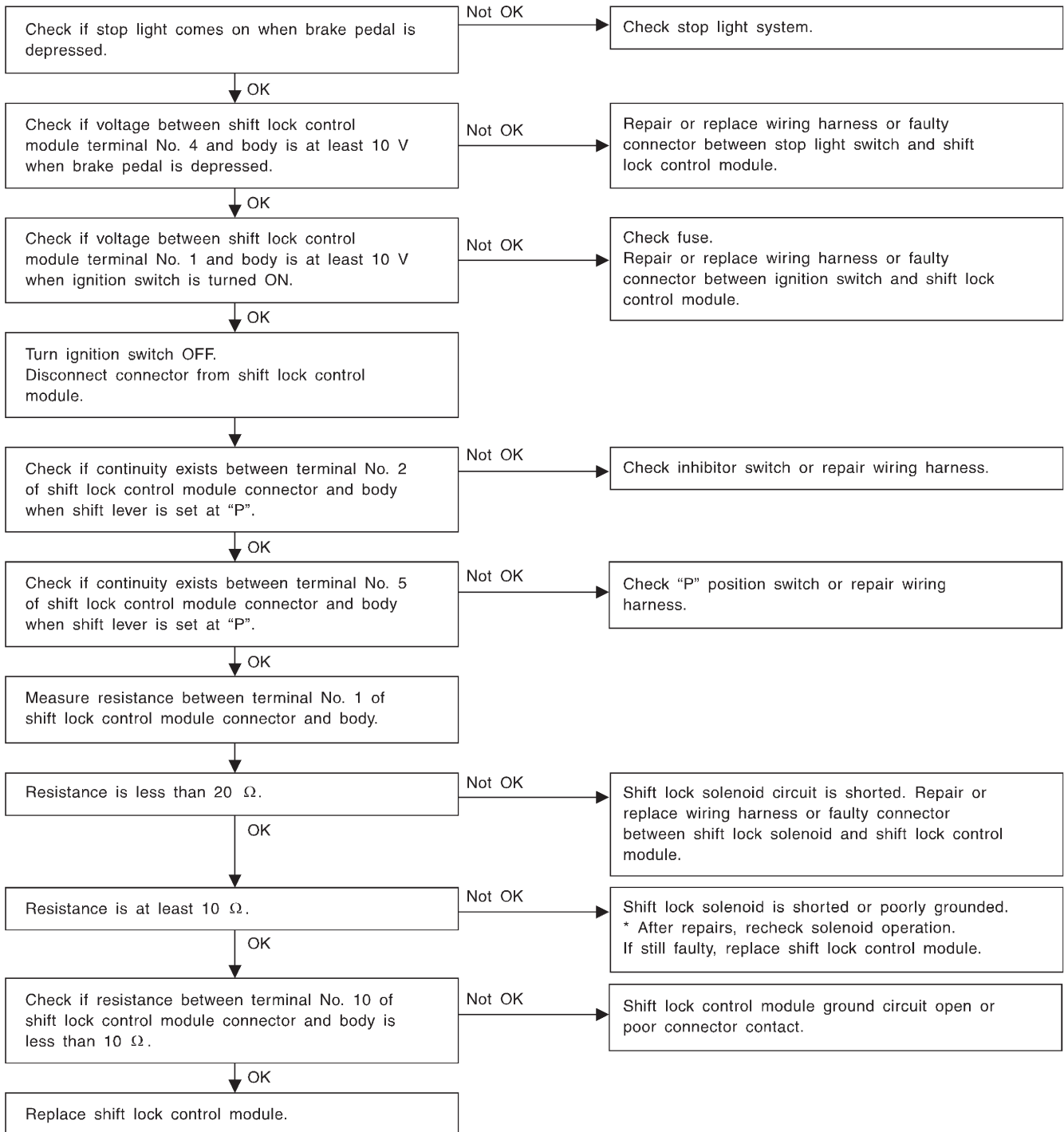

B6M0725

E: DIAGNOSTICS PROCEDURE NO. 3 (KEY INTERLOCK DOES NOT OPERATE.)

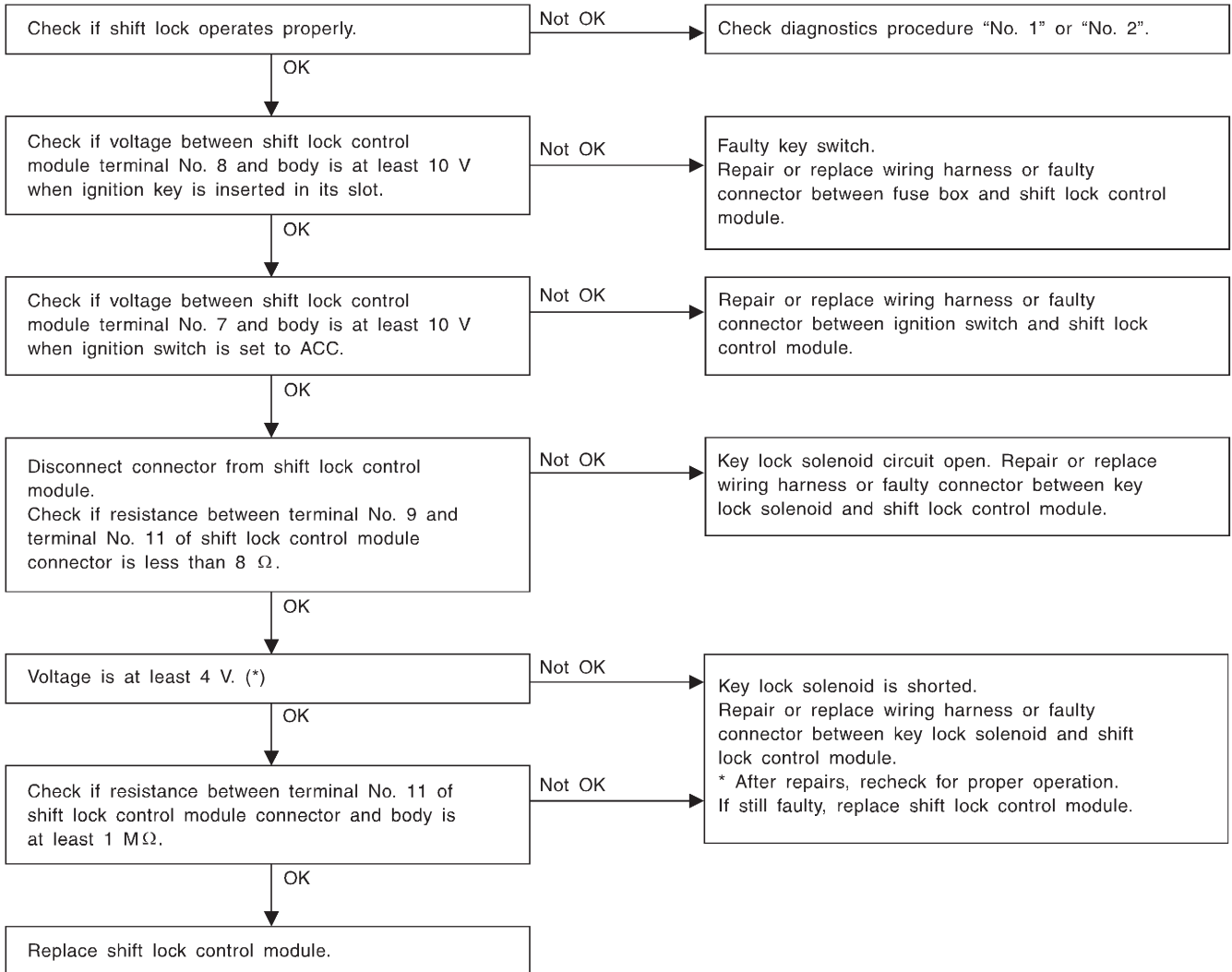

* : When conducting operational checks of the key lock solenoid, do not apply 12 V to solenoid for more than one second, since this may break solenoid circuit.

6-2b [T2F0] BODY ELECTRICAL SYSTEM (ELECTRICAL PARTS)

2. AT Shift Lock System

F: DIAGNOSTICS PROCEDURE NO. 4 (KEY INTERLOCK DOES NOT RELEASE.)

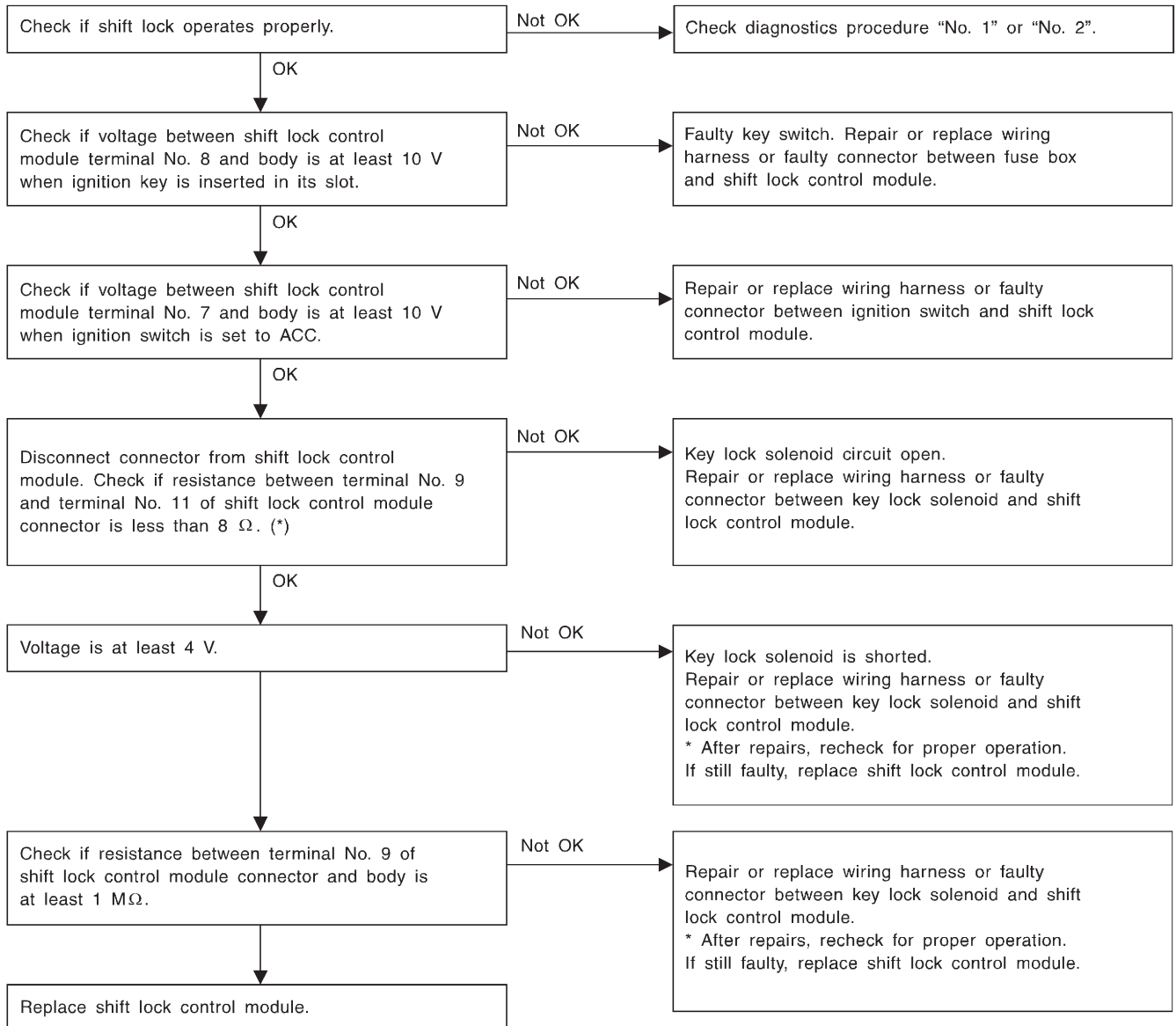

* : When conducting operational checks of the key lock solenoid, do not apply 12 V to solenoid for more than one second, since this may break solenoid circuit.