

Audio

| | |
|---|------|
| <i>Antenna system</i> | 5-2 |
| <i>Installation of accessories</i> | 5-3 |
| <i>Audio set</i> | 5-3 |
| <i>Type P119 and P120 audio set (if equipped)</i> | 5-7 |
| <i>Type P121 audio set (if equipped)</i> | 5-19 |
| <i>Type C117 audio set (if equipped)</i> | 5-33 |
| <i>CD player 1 (if equipped)</i> | 5-39 |
| <i>CD player 2 (if equipped)</i> | 5-41 |
| <i>In-dash 6 CD auto changer (if equipped)</i> | 5-44 |
| <i>Precautions to observe when handling a compact disc (CD)</i> | 5-47 |

Antenna system

▼ Printed antenna

CAUTION

Do not use sharp instruments or window cleaner containing abrasives to clean the inner surface of the window on which the antenna is printed. Doing so may damage the antenna printed on the window.

The antenna is printed on the inside of the rear window glass (sedan) or the left side rear quarter window glass (station wagon).

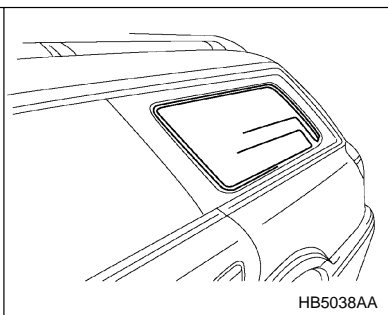
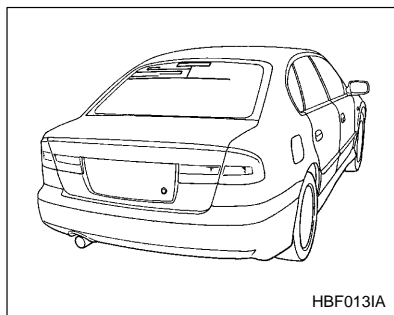

▼ Pillar mounted antenna

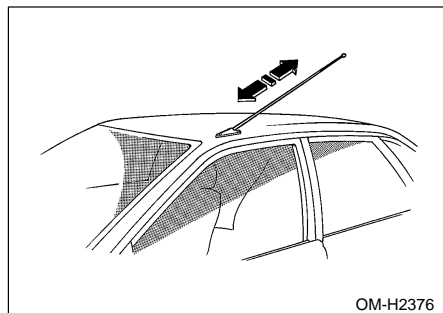

Pull the antenna out to extend it to its full length.

▼ FM reception

Although FM is normally static free, reception can be affected by the surrounding area, atmospheric conditions, station strength and transmitter distance. Buildings or other obstructions may cause momentary static, flutter or station interference. If reception continues to be unsatisfactory, switch to a stronger station.

Installation of accessories

Always consult your SUBARU dealer before installing a citizen band radio or other transmitting device in your vehicle. Such devices may cause the electronic control system to malfunction if they are incorrectly installed or if they are not suited for the vehicle.

Audio set

Your SUBARU may be equipped with one of the following audio sets. See the pages indicated in this section for operating details. The audio type code number is found on the lid of the cassette slot.

▼ Type P119 and type P120 audio set

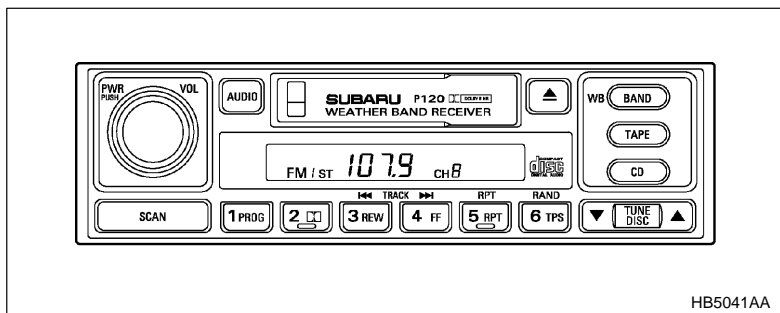

- Radio operation: refer to page 5-7
- Cassette player operation: refer to page 5-11
- CD player control: refer to page 5-13
- CD changer control: refer to page 5-16

– CONTINUED –

▼ Type P121 audio set

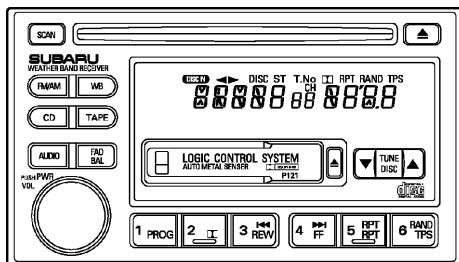

HB5042AA

- Radio operation: refer to page 5-19
- Cassette player operation: refer to page 5-24
- CD (compact disc) player operation: refer to page 5-27
- CD changer control: refer to page 5-30

▼ Type C117 audio set

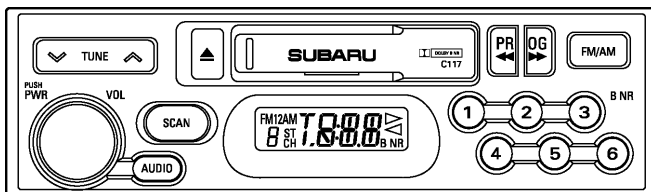

HB5043AA

- Radio operation: refer to page 5-33
- Cassette player operation: refer to page 5-37
- CD player control: refer to page 5-39

▼ CD player 1 (Optional audio unit — if equipped)

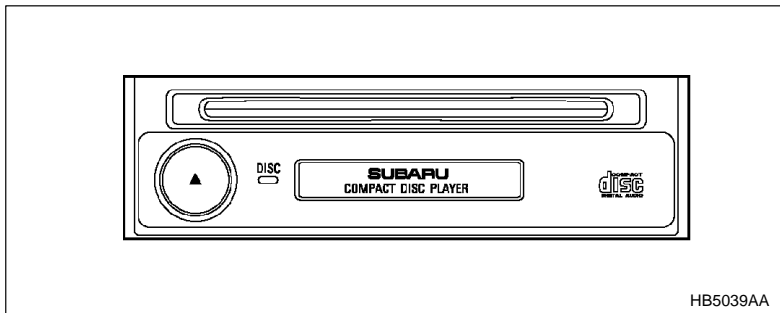

- Inserting and removing a disc: refer to page 5-39

▼ CD player 2 (Optional audio unit — if equipped)

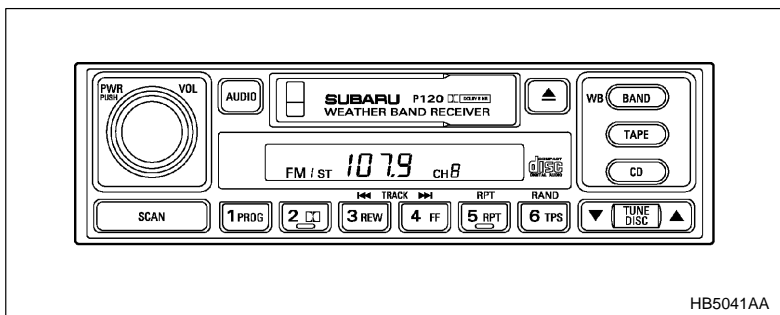

- CD (compact disc) player operation: refer to page 5-41

▼ In-dash 6 CD auto changer (Optional audio unit — if equipped)

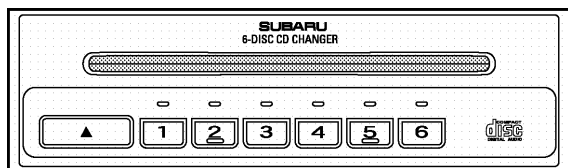

HB5040AA

- Inserting and removing a disc or all discs: refer to page 5-44

Type P119 and P120 audio set (if equipped)

* The audio type code number is found on the lid of the cassette slot.

Type P119: Without weather band

Type P120: With weather band

The audio set will operate only when the ignition switch is in the "ACC" or "ON" position.

Radio operation

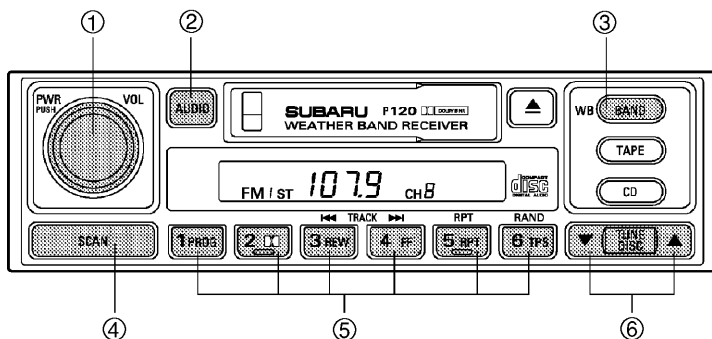

HB5041BB

- | | |
|---|------------------|
| ① Power switch/Volume, Tone, Balance, Fader control dial | ④ Tuning buttons |
| ② AUDIO button | ⑤ Preset buttons |
| ③ BAND button | ⑥ SCAN button |

▼ Power switch and volume/bass/treble/fader/balance control

▽ Power switch and volume control (PWR/VOL)

The dial ① is used for both power (ON/OFF) and volume control. The radio is turned ON and OFF by pushing the dial and the volume is controlled by turning the dial.

– CONTINUED –

▽ Tone and balance control (AUDIO)

The volume control dial ① normally functions as a volume control. This dial becomes a control for Bass, Treble, Fader or Balance when you select the appropriate tone and balance control mode.

Choose desired volume level for each mode by turning the volume control dial. The control function returns to volume control mode after about 5 seconds.

To change control modes: Each brief press of the “AUDIO” button ② changes control modes in the following sequence starting from volume control mode. (When the radio is first turned on, the control mode is in the volume control.)

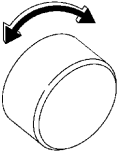

The “AUDIO” button ② is used for selecting the following control modes:

| Display | Control mode |  HB5036BA | |
|------------|-----------------|---|---|
| | | Turn counterclockwise | Turn clockwise |
| BAS | Bass control | For less bass | For more bass |
| TRE | Treble control | For less treble | For more treble |
| FAd | Fader control | To increase rear speaker volume and decrease front speaker volume | To increase front speaker volume and decrease rear speaker volume |
| BAL | Balance control | To increase left speaker volume and decrease right speaker volume | To increase right speaker volume and decrease left speaker volume |
| VOL | Volume control | For less volume | For more volume |

▼ Waveband selection

▽ FM/AM selection (P119 type audio set)

Push the "BAND" button ③ to select FM1, FM2 or AM reception. The display indicates which one is currently selected.

▽ FM/AM/Weather band selection (P120 type audio set)

Push the "BAND" button ③ to select FM1, FM2, AM or Weather band (WB) reception. The display indicates which is currently selected.

▼ Stereo indicator

The stereo indicator "ST" will come on when an FM stereo broadcast is received.

▼ Tuning (TUNE)

▽ Manual tuning (TUNE)

Press the tuning button ④ marked "▲" to increase the tuning frequency and press the tuning button marked "▼" to decrease it.

Each time the button is pressed, the frequency interval can be changed between 10 kHz in the AM mode and 0.2 MHz in the FM mode.

Constant pressure on the button causes a continuous change in the frequency.

▽ Manual tuning for weather band

When weather band mode is selected, press the tuning button ④ marked "▲" to change the WB channel up and press the tuning button marked "▼" to change the WB channel down. Each time the button is pressed, the WB channel changes to the next channel. Constant pressure on the button causes a continuous change in the frequency.

▽ Automatic tuning (SCAN)

Press the "SCAN" button ⑥ to change the radio to the SCAN mode. In this mode, the radio scans through the radio band until a station is found. The radio will stop at the station for five seconds while displaying the frequency, after which scanning will continue until the entire band has been scanned from the low end to the high end.

Press the "SCAN" button again to cancel the SCAN mode and to stop on any displayed frequency.

When the "SCAN" button is pressed for automatic tuning, stations are scanned in the direction of low frequencies to high frequencies only.

Automatic tuning may not function properly if the station reception is weakened by distance from the station or proximity to tall buildings and hills.

▼ Selecting preset stations

Presetting a station with a "preset button" ⑤ allows you to select that station in a single operation. Up to six WB (if equipped), AM, FM1 and FM2 stations each may be preset.

▼ How to preset stations

1. Press the "BAND" button ③ to select FM1, FM2, AM or WB (if equipped) reception.
2. Press the "SCAN" button or tune the radio manually until the desired station frequency is displayed.
3. Press one of the preset buttons for more than 2 seconds to store the frequency. At this time, there will momentarily be no sound from the radio. If the button is pressed for less than 2 seconds, the preceding selection will remain in memory.

NOTE

If the connection between the radio and battery is broken for any reason such as vehicle maintenance or radio removal, all stations stored in the preset buttons are cleared. If this occurs, it is necessary to reset the preset buttons.

Cassette player operation

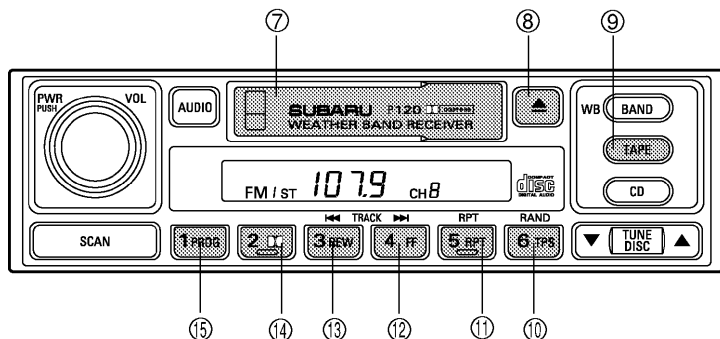

HB5041CB

- | | |
|-----------------------------|-----------------------|
| ⑦ Cassette slot | ⑫ Fast-forward button |
| ⑧ Eject button | ⑬ Rewind button |
| ⑨ TAPE button | ⑭ Dolby B NR button |
| ⑩ TPS (Tape Program Search) | ⑮ Program button |
| ⑪ Repeat button | |

NOTE

- Only use good quality cassettes (cassettes longer than C-90 are not recommended).
- Put cassettes back in their boxes immediately after use to protect them from dust and dirt and to prevent the tape from unwinding.
- Never expose cassettes to heat, direct sunlight or moisture.
- Clean the tape head (once or twice a month) using a *wet-type cleaning cassette*.

▼ Cassette slot

Insert a cassette with the exposed tape side facing to the right. After insertion, playback starts.

▼ TAPE button

Press the "TAPE button" ⑨ when the cassette left in the cassette slot is to be played back again.

– CONTINUED –

▼ Tape travel indicators

These indicate the direction the cassette tape is moving.

▶ : Indicates that the top side of the cassette is being played back.

◀ : Indicates that the bottom side of the cassette is being played back.

▼ Program button (PROG)

When the program button ⑮ is pressed during playback, the tape travel indicators will switch and the player will begin playing back the opposite side of the tape. The same mechanism is automatically activated when the end of the tape is reached. This allows the opposite side of the tape to play, providing continuous playback.

▼ Fast-forward button (FF)

To fast-forward the tape, press the "FF" button ⑫. To stop fast-forwarding, lightly press the "▲" ⑧ button.

▼ Rewind button (REW)

To rewind the tape, press the "REW" button ⑬. To stop rewinding, lightly press the "▲" ⑧ button.

▼ Eject button (▲)

When "▲" button ⑧ is pressed, playback stops and the cassette tape is ejected.

The ejection function is also active when the ignition switch is in the "LOCK" position. Always make certain that you remove the cassette tape.

▼ Repeat (RPT)

Press the "RPT" button ⑪ while a song is playing to play the song repeatedly. The "RPT" indicator will come on and the song will be played continuously. To cancel the repeat mode, press the button again. Then the "RPT" indicator goes out, and normal playback mode is restored.

▼ Dolby B NR button ()

Press the “ ” button ¹⁴ when playing tapes recorded using the Dolby NR system*. The “ ” indicator will light up and high-frequency noise on the tape will be reduced for clearer sound reproduction.

*Noise reduction system manufactured under license from Dolby Laboratories Licensing Corporation. “Dolby” and the double-D Symbol are trade marks of Dolby Laboratories Licensing Corporation.

CD player control (If optional CD player is connected)

An optional CD player can be connected to this audio unit. See your SUBARU dealer for more information. For procedures for loading and unloading CDs, refer to “CD player 1” in this chapter.

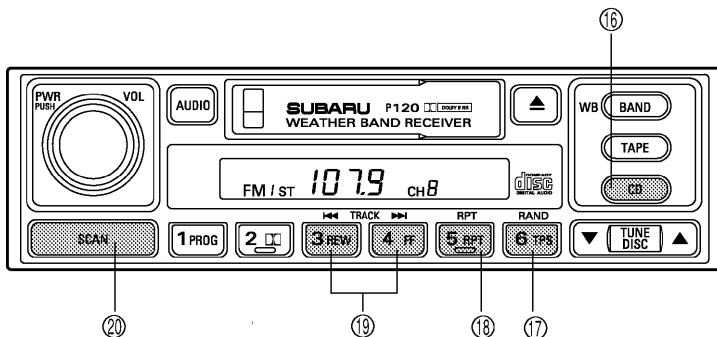

HB5041DB

- 16 CD button
- 17 RAND (Random) button
- 18 RPT (Repeat) button
- 19 Track selection buttons
- 20 SCAN button

▼ To start playback

▽ When CD is not in the CD player

Hold a disc with a finger in the center hole while gripping the edge of the disc, then insert it in to the slot (with the label side up) on the CD player and the player will automatically pull the disc into position.

– CONTINUED –

After insertion, the CD player mode indicator “CD” will come on and playback will start.

▽ **When CD is in the CD player**

Press the “CD” button ⑯. The “CD” indicator will come on, and the track number will appear on the display and the CD player will start playback.

NOTE

- **If the “CD” button is pressed during a radio broadcast, the disc will interrupt the broadcast.**
- **After playback on the last song finishes, the player will automatically return to track 1 (the first song on the disc).**

▼ **To select a song from its beginning**

Briefly press the “▶▶▶” button ⑲ to skip to the beginning of the next track and briefly press the “◀◀◀” button to skip to the beginning of the current track.

▼ **Fast-forwarding and fast-reverse**

Press the “▶▶▶” button ⑲ continuously for more than a half second to fast-forward the disc.

Press the “◀◀◀” button continuously for more than a half second to fast reverse the disc.

Release the button to stop fast forwarding or fast reverse.

▼ **Repeat**

Press the “RPT” button ⑳ while a song is playing to play the song repeatedly. The “RPT” indicator will come on and the song will be played continuously. To cancel the repeat mode, press the button again. Then the “RPT” indicator goes out, and normal playback mode is restored.

▼ **Random playback**

Press the “RAND” button ㉑ while a disc is being played back to play all songs on the disc in a random order. The “RAND” indicator will come on and all songs on the disc will be played in a random order.

To cancel the random mode, press the button again. Then the “RAND” indicator goes out, and normal playback mode is restored.

▼ Scan (a convenient way to become familiar with a disc)

1. Press the "SCAN" button 
 - The display shows "SCAN" and the track number being scanned.
 - You hear the first 10 seconds of each track.
 - The operation is automatically cleared after playing all programs. Then, normal playback starts.
2. Press the "SCAN" button again when you hear a track you like.
 - Normal playback resumes.

▼ To stop playback

To stop playback and switch over to the radio mode, press the "BAND" button. To stop playback and switch over to the cassette player mode, press the "TAPE" button.

CD changer control (If optional in dash CD changer is connected)

An optional CD changer can be connected to this audio unit. See your SUBARU dealer for more information. For procedures for loading and unloading CDs, refer to "In-dash 6 CD auto changer" in this chapter.

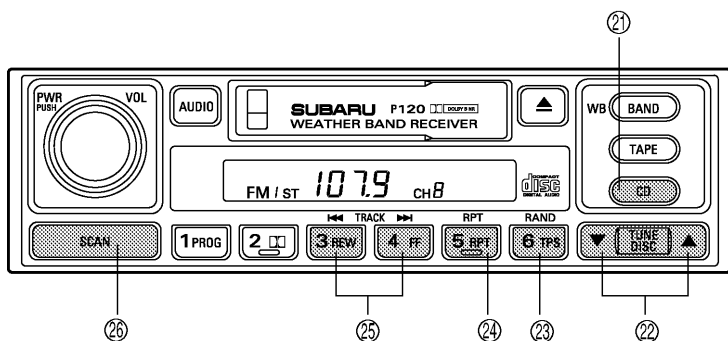

HB5041EB

- | | |
|------------------------|---------------------------|
| ① CD button | ④ RPT (Repeat) button |
| ② Disc up/down buttons | ⑤ Track selection buttons |
| ③ RAND (Random) button | ⑥ SCAN button |

▼ To start playback

Press the "CD" button ①. The "CD" indicator will come on and the disc number will appear on the display and the CD changer will start playback.

NOTE

- If the "CD" button is pressed during a radio broadcast, the CD changer will interrupt the broadcast.
- At the end of the disc, playback automatically continues with the next disc.
- After playback on the last disc finishes, the player will automatically return to the first disc.

- **If you have loaded fewer than 6 discs, any missing disc is automatically skipped.**

▼ Selection of a desired disc

Briefly press the “▲” button ⑳ to skip to the next disc and briefly press the “▼” button to skip to the previous disc.

▽ Operation with the in-dash CD changer unit

Press the desired “Disc select” button (numbered from 1 to 6) and the disc will begin to play.

▼ To select a song from its beginning

Briefly press the “▶▶▶” button ㉑ to skip to the beginning of the next track and briefly press the “◀◀◀” button to skip to the beginning of the current track.

▼ Fast-forwarding and fast-reverse

Press the “▶▶▶” button ㉑ continuously for more than a half second to fast-forward the disc.

Press the “◀◀◀” button continuously for more than a half second to fast reverse the disc.

Release the button to stop fast forwarding or fast reverse.

▼ Repeat

Press the “RPT” button ㉒ while a song is playing to play the song repeatedly. The “RPT” indicator will come on and the song will be played continuously. To cancel the repeat mode, press the button again. Then the “RPT” indicator goes out, and normal playback mode is restored.

▼ Random playback

Press the “RAND” button ㉓ while a disc is being played back to play all songs on the disc in a random order. The “RAND” indicator will come on and all songs on the disc will be played in a random order. To cancel the random mode, press the button again. Then the “RAND” indicator goes out, and normal playback mode is restored.

▼ Scan (a convenient way to become familiar with a disc)

1. Press the "SCAN" button .
 - The display shows "SCAN" and the track number being scanned.
 - You hear the first 10 seconds of each track.
 - The operation is automatically cleared after playing all programs. Then, normal playback starts.
2. Press the "SCAN" button again when you hear a track you like.
 - Normal playback resumes.

▼ To stop playback

To stop playback and switch over to the radio mode, press the "BAND" button. To stop playback and switch over to the cassette player mode, press the "TAPE" button.

Type P121 audio set (if equipped)

* The audio type code number is found on the lid of the cassette slot.

The radio will operate only when the ignition switch is in the "ACC" or "ON" position.

Radio operation

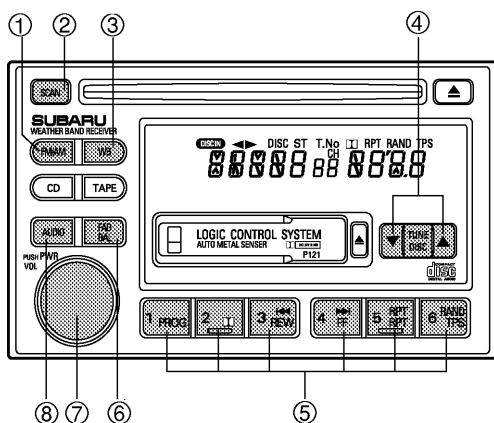

HB5042BB

- | | |
|----------------------------|---|
| ① FM/AM selection button | ⑥ Fader/Balance selection button |
| ② SCAN button | ⑦ Power switch, Volume control, Bass/Middle/Treble control and Fader/Balance control dial |
| ③ WB (weather band) button | ⑧ AUDIO (audio mode) button |
| ④ Tuning buttons | |
| ⑤ Preset buttons | |

▼ Power switch and volume/bass/treble/fader/balance control (PWR/VOL)

The dial ⑦ is used for both power (ON/OFF) and volume control. The radio is turned ON and OFF by pushing the dial and the volume is controlled by turning the dial.

– CONTINUED –

This dial is used for bass/middle/treble controls when the "AUDIO" button ⑧ is in the depressed position. It is also used for fader/balance controls when the "FAD/BAL" button ⑥ is in the depressed position.

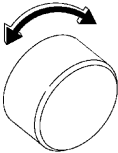
| Display | Control mode |  HB5036BA | |
|------------|---------------------|---|---|
| | | Turn counterclockwise | Turn clockwise |
| BAS | Bass control | For less bass | For more bass |
| Mld | Middle note control | For less middle note | For more middle note |
| TRE | Treble control | For less treble | For more treble |
| FAd | Fader control | To increase rear speaker volume and decrease front speaker volume | To increase front speaker volume and decrease rear speaker volume |
| BAL | Balance control | To increase left speaker volume and decrease right speaker volume | To increase right speaker volume and decrease left speaker volume |
| VOL | Volume control | For less volume | For more volume |

▽ Tone control

The volume control dial ⑦ normally function as volume control. The dial become a control for Bass, Middle note or Treble when you select the appropriate tone control mode.

Choose desired level for each mode by turning the volume control dial. The control function returns to volume control mode after about 5 seconds.

To change control modes: Each brief press of the "AUDIO" button ⑧ changes control modes in the following sequence starting from bass control mode. (When the radio is first turned on, the control mode is in the volume control.)

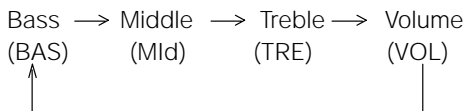

▽ Fader and balance control

The volume control dial ⑦ normally function as volume control. The dial become the controls for Fader or Balance when you select the appropriate fader and balance control mode.

Choose desired setting for each mode by turning the volume control dial. The control function returns to volume control mode after about 5 seconds.

To change control modes: Each brief press of the “FAD/BAL” button ⑥ changes control modes in the following sequence starting from fader control mode. (When the radio is turned on, the control mode is in the volume control.)

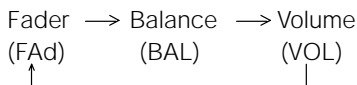

▽ Display illumination dimness cancellation

The brightness of the radio display dims when the light switch is in the “P” or “W” positions. If this makes the display difficult to read, press the volume dial for more than two seconds to return the display to original brightness.

▼ FM/AM selection button (FM/AM)

Push the “FM/AM” button ① when the radio is off to turn on the radio. Push the “FM/AM” button when the radio is on to select FM1, FM2 or AM reception. Each time this button is pressed, the band will change in the following order:

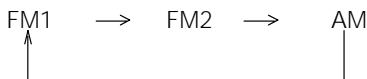

The display indicates which one is currently selected.

– CONTINUED –

▼ Stereo indicator

The stereo indicator "ST" will come on when an FM stereo broadcast is received.

▼ Weather band button (WB)

Push the "WB" button ③ when the radio is off to turn on the radio in the weather band.

Press the "WB" button when the radio is on to select the weather band.

▼ Manual tuning (TUNE)

▽ Manual tuning for AM and FM waveband

Push the tuning button ④ marked "▲" to increase the tuning frequency and press the tuning button marked "▼" to decrease it.

Each time the button is pressed, the frequency changes 10 KHz in the AM waveband and 0.2 MHz in the FM waveband.

Constant pressure on the button causes a continuous change in the frequency.

▽ Manual tuning for weather band

When weather band mode is selected, press the tuning button ④ marked "▲" to change the WB channel up and press the tuning button marked "▼" to change the WB channel down. Each time the button is pressed, the WB channel changes to the next channel. Constant pressure on the button causes a continuous change in the channel.

▼ Automatic tuning (SCAN)

Press the "SCAN" button ② to change the radio to the SCAN mode. In this mode, the radio scans through the radio band until a station is found. The radio will stop at the station for five seconds while displaying the frequency, after which scanning will continue until the entire band has been scanned from the low end to the high end.

Press the "SCAN" button again to cancel the SCAN mode and to stop on any displayed frequency.

When the "SCAN" button is pressed for automatic tuning, stations are scanned in the direction of low frequencies to high frequencies only.

Automatic tuning may not function properly if the station reception is weakened by distance from the station or proximity to tall buildings and hills.

▼ **Selecting preset stations**

Presetting a station with a preset button ⑤ allows you to select that station in a single operation. Up to six AM, FM1, FM2 and WB stations each may be preset.

▼ **How to preset stations**

1. Press the "FM/AM" selection button to select AM, FM1 or FM2 reception.

OR

Press the "WB" button ③ to select the weather band.

2. Press the "SCAN" button ② or tune the radio manually until the desired station frequency is displayed.

3. Press one of the preset buttons ⑤ for **at least 1.5 seconds** to store the frequency. The frequency of the station will flash once on the display at this time. If the button is pressed for less than 1.5 seconds, the preceding selection will remain in memory.

NOTE

If the connection between the radio and battery is broken for any reason such as vehicle maintenance or radio removal, all stations stored in the preset buttons are cleared. If this occurs, it is necessary to reset the preset buttons.

Cassette player operation

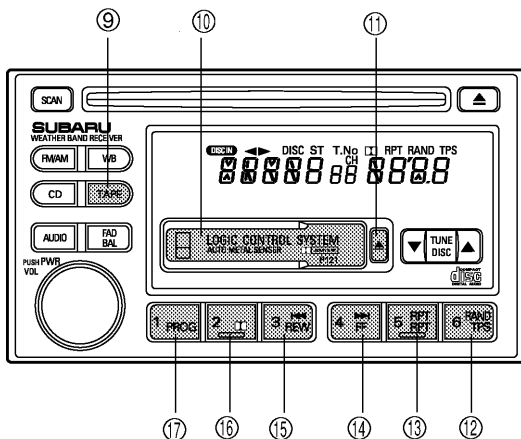

HB5042CB

- | | |
|---|----------------------------|
| ⑨ TAPE (cassette player selection) button | ⑬ Repeat button |
| ⑩ Cassette slot | ⑭ Fast forward button |
| ⑪ Eject button | ⑮ Rewind button |
| ⑫ TPS button | ⑯ Dolby B NR button |
| | ⑰ Program switching button |

NOTE

- Only use good quality cassettes (cassettes longer than C-90 are not recommended).
- Put cassettes back in their boxes immediately after use to protect them from dust and dirt and to prevent the tape from unwinding.
- Never expose cassettes to heat, direct sunlight or moisture.
- Clean the tape head (once or twice a month) using a *wet-type cleaning cassette*.

▼ To play back a cassette tape

▽ When cassette tape is not in the player

When a cassette is partially inserted, it is automatically drawn in and starts tape playback.

▽ **When cassette tape is in the player**

When the "TAPE" button ⑨ is pressed, the display will show "PLAY" and the player will start playback.

▼ **Tape travel indicators**

These indicate the direction the cassette tape is moving.

▶ : indicates that the top side of the cassette is being played back.

◀ : indicates that the bottom side of the cassette is being played back.

▼ **Program switching button (PROG)**

When the program switching button "PROG" ⑰ is pressed during playback, the tape travel indicators will switch and the player will begin playing back the opposite side of the tape. The same mechanism is automatically activated when the end of the tape is reached. This allows the opposite side of the tape to play, providing continuous playback.

▼ **Fast-forward button (FF)**

To fast-forward the tape, press the "FF" button ⑭. The display will show "FF". To stop fast-forwarding, press the "FF" or "TAPE" ⑨ button.

▼ **Rewind button (REW)**

To rewind the tape, press the "REW" button ⑮. The display will indicate "REW". To stop rewinding, press the "REW" or "TAPE" ⑨ button.

▼ **Eject button (▲)**

When "▲" button ① is pressed, play back stops and the cassette tape is ejected.

The ejection function also operates when the ignition switch is in the "LOCK" position. Always make certain that you remove the cassette tape.

▼ **Tape program sensor button (TPS)**

▽ **Blank skip**

When the "TPS" button ⑫ is pressed, the "TPS" indicator will come on and the player will automatically skip any blank portion of 15 second or more and play the next program, even if it is on the other side. To cancel blank skip mode, press the "TPS" button again.

– CONTINUED –

▽ Blank search

Press "TPS" button ⑫ during playback to return to the beginning of the current selection or to skip to the beginning of the next selection. To use this function, press the "TPS" button to turn on the "TPS" indicator. If the fast-forward button "FF" ⑭ is then pressed, the player advances the tape to the beginning of the next selection and starts playing it. If the rewind button "REW" ⑮ is pressed instead, the player rewinds the tape to the beginning of the current selection and starts replaying it. The "TPS" function may not operate properly under the following conditions:

- When the recording level is low.
- When there are long pauses in the middle of a selection.
- When the tape contains verbal material such as conversations.
- When the blanks between selections are shorter than five seconds.
- When there are no blanks between selections (live concerts, etc.).

▼ Repeat button (RPT)

Push the "RPT" button ⑬ to repeat the piece of music being listened to. To use this function, push the "RPT" button while the piece you want to hear again is being played. "RPT" will be indicated on the display. When the selection ends, the cassette player automatically rewinds to the beginning of the piece and the selection begins again. To cancel the repeat function, push the "RPT" button again. Until the repeat function is cancelled, the same piece of music will be repeated indefinitely. The "RPT" function may not operate properly under the following conditions:

- When the recording level is low.
- When there are long pauses in the middle of a selection.
- When the tape contains verbal material such as conversations.
- When the blanks between selections are shorter than five seconds.
- When there are no blanks between selections (live concerts, etc.).

▼ Dolby B NR button (□□)

Press "□□" button ⑯ when playing tapes recorded using the Dolby NR system*. The "□□" indicator will light up and high-frequency noise on the tape will be reduced for clearer sound reproduction.

* Noise reduction system manufactured under license from Dolby Laboratories Licensing Corporation. "Dolby" and the double-D Symbol are trade marks of Dolby Laboratories Licensing Corporation.

▼ Auto metal sensor

The cassette player automatically adjusts for metal or CrO₂ tape.

Compact disc player operation

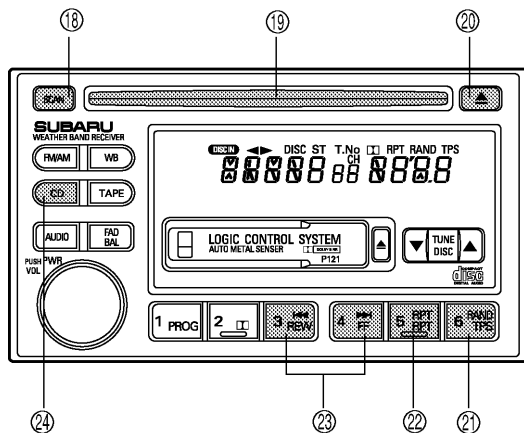

HB5042DB

- | | |
|-----------------|-----------------------------------|
| ⑱ SCAN button | ⑳ Repeat button |
| ⑲ Disc slot | ㉑ Track selection buttons |
| ㉒ Eject button | ㉒ Repeat button |
| ㉓ Random button | ㉓ Track selection buttons |
| | ㉔ CD (CD player selection) button |

▼ To play back a compact disc

▽ When CD is not in the player

Hold a disc with a finger in the center hole while gripping the edge of the disc, then insert it in to the slot (with the label side up) and the player will automatically pull the disc into position.

A single CD (8 cm/3 inch CD) may also be used without any adapter.

– CONTINUED –

After insertion, the DISC indicator "  " will come on and "CD" will appear on the display and the player will start playback.

NOTE

- **Make sure to always insert a disc with the label side up. If a disc is inserted with the label side down, it might be ejected or the player might shut off.**
- **After the last song finishes, the player will automatically return to track 1 (the first song on the disc).**

▽ When CD is in the player



Press the "CD" button . The display will show "CD" and the player will start playback.

NOTE



After the last song finishes, playback will automatically return to track 1 (the first song on the disc).

▼ To select a song from its beginning

▽ Forward direction



Briefly press the "" button  to skip to the beginning of the next track. Each time the button is pressed, the indicated track number will increase.

▽ Backward direction

Briefly press the "" button  to skip to the beginning of the current track. Each time the button is pressed, the indicated track number will decrease.



▼ Fast forwarding and fast reverse

▽ Fast forwarding

Press the "" button  continuously for more than 0.5 second to fast forward the disc.

Release the button to stop fast forwarding.

▽ Fast reverse

Press the "" button  continuously for more than 0.5 second to fast reverse the disc.

Release the button to stop fast reverse.

▼ Repeat playback

Press the "RPT" button (22) while a song is playing to play the song repeatedly. The "RPT" indicator will come on and the song will be played continuously. To cancel the repeat mode, press the button again. Then the "RPT" indicator goes out, and normal playback mode is restored.

▼ Random playback

Press the "RAND" button (21) while a disc is being played back to play all songs on the disc in a random order. The "RAND" indicator will come on and all songs on the disc will be played in a random order. To cancel the random mode, press the button again. Then the "RAND" indicator goes out, and normal playback mode is restored.

▼ Scan

When the "SCAN" button (18) is pressed while the disc is being played back, you can hear the first 10 seconds of each track to search for the desired program. To continue listening to the program, press the "SCAN" button again. After all tracks on the disc have been scanned, normal playback mode is restored.

▼ To eject a disc from the player

When a disc is being played back or when a disc is in the player, press the eject button "▲" (20). The disc will be ejected.

The disc may be removed even when the ignition switch is in the "LOCK" position.

NOTE

Avoid driving the vehicle with a CD sticking out, because vibration might make it fall out.

CD changer control (If optional in-dash CD changer is connected)

An optional CD changer can be connected to this audio unit. See your SUBARU dealer for more information. For procedures for loading and unloading CDs, refer to "In-dash 6 CD auto changer" in this chapter.

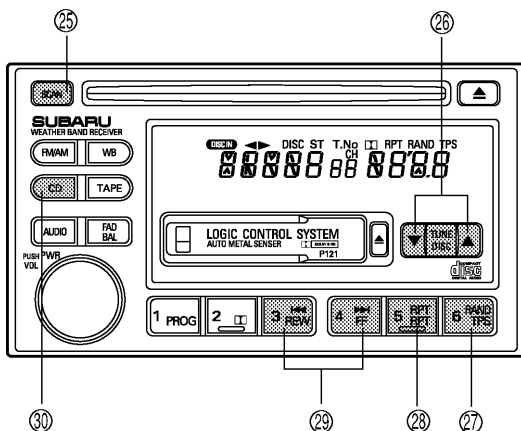

HB5042EB

- | | | | |
|----|---------------------|----|-------------------------|
| 25 | SCAN button | 28 | Repeat button |
| 26 | Disc up/down button | 29 | Track selection buttons |
| 27 | Random button | 30 | CD button |

▼ To start playback

When the "CD" button (30) is pressed, the CD changer will start playback. The display shows the current disc number, track number and the elapsed time during playback.

NOTE

- If a disc is in the player, the “CD” button is used to change from CD player operation to CD changer operation. Each time the “CD” button is pressed, the operating mode will change alternately.
- At the end of the disc, the player automatically continues with the next disc.
- After playback on the last disc finishes, playback will automatically return to the first disc.
- If you have loaded fewer than 6 discs, any missing disc is automatically skipped.

▼ Selection of a desired disc

Briefly press the “▲” button ⁽²⁸⁾ to skip to the next disc and briefly press the “▼” button to skip to the previous disc.

▽ Operation with the in-dash CD changer unit

Press the desired “Disc select” button (numbered from 1 to 6) and the disc will begin to play.

▼ To select the desired disc

Press either the disc up button “DISC ▲” ⁽²⁶⁾ or disc down button “DISC ▼” to select the desired disc. Each time the “DISC ▲” ⁽²⁶⁾ button is pressed, the indicated disc number will increase. Each time the “DISC ▼” button is pressed, the indicated disc number will decrease. Constant pressure on these buttons causes a continuous change in the disc number.

▼ To select a song from its beginning

▽ Forward direction

Briefly press the “▶▶▶” button ⁽²⁹⁾ to skip to the beginning of the next track. Each time the button is pressed, the indicated track number will increase.

▽ Backward direction

Briefly press the “◀◀◀” button ⁽²⁹⁾ to skip to the beginning of the current track. Each time the button is pressed, the indicated track number will decrease.

– CONTINUED –

▼ Fast forwarding and fast reverse

▽ Fast forwarding

Press the “▶▶▶” button ²⁹ continuously for more than 0.5 second to fast forward the disc.

Release the button to stop fast forwarding.

If you continue fast forwarding to the end of the disc, the CD changer will automatically stop fast forwarding and start playback beginning with the first track on the current disc.

▽ Fast reverse

Press the “◀◀◀” button ²⁹ continuously for more than 0.5 second to fast reverse the disc.

Release the button to stop fast reverse.

If you continue fast reverse to the beginning of the disc, the CD changer will automatically stop fast reverse and start playback beginning with the first track on the current disc.

▼ Repeat playback

Press the “RPT” button ²⁸ while a song is playing to play the song repeatedly. The “RPT” indicator will come on and the song will be played continuously. To cancel the repeat mode, press the button again. Then the “RPT” indicator goes out, and normal playback mode is restored.

▼ Random playback

Press the “RAND” button ²⁷ while a disc is being played back to play all songs on the disc in a random order. The “RAND” indicator will come on and all songs on the disc will be played in a random order. To cancel the random mode, press the button again. Then the “RAND” indicator goes out, and normal playback mode is restored.

▼ Scan

When the “SCAN” button ²⁵ is pressed while the disc is being played back, you can hear the first 10 seconds of each track to search for the desired program. To continue listening to the program, press the “SCAN” button again. After all tracks on the disc have been scanned, normal playback mode is restored.

Type C117 audio set (if equipped)

* The audio type code number is found on the lid of the cassette slot.
The audio set will operate only when the ignition switch is in the "ACC" or "ON" positions.

Radio operation

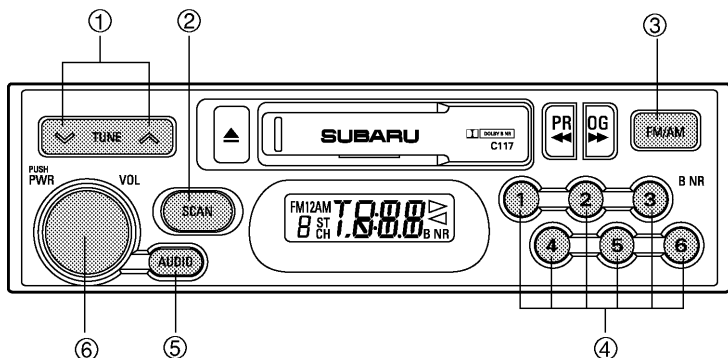

HB5043BB

- | | |
|--------------------------|-----------------------------------|
| ① Tuning buttons | ⑤ AUDIO button |
| ② SCAN button | ⑥ Power switch and volume control |
| ③ FM/AM selection button | |
| ④ Preset buttons | |

▼ Power switch and volume/bass/treble/fader/balance control

▽ Power switch and volume control (PWR/VOL)

The dial ⑥ is used for both power (on/off) and volume control. The radio is turned on and off by pushing the dial and the volume is controlled by turning the dial.

▼ Tone and balance control

The volume control dial ⑥ normally functions as a volume control. This dial becomes a control for Bass, Treble, Fader or Balance when you select the appropriate tone and balance control mode.

– CONTINUED –

Choose desired volume level for each mode by turning the volume control dial. The control function returns to volume control mode after about 5 seconds.

To change control modes: Each brief press of the “AUDIO” button ⑤ changes control modes in the following sequence starting from volume control mode. (When the radio is first turned on, the control mode is in the volume control.)

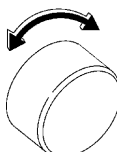

The “AUDIO” button ⑤ is used for selecting the following control modes:

| Display | Control mode |  HB5036BA | |
|------------|-----------------|---|---|
| | | Turn counterclockwise | Turn clockwise |
| BAS | Bass control | For less bass | For more bass |
| TRE | Treble control | For less treble | For more treble |
| FAD | Fader control | To increase rear speaker volume and decrease front speaker volume | To increase front speaker volume and decrease rear speaker volume |
| BAL | Balance control | To increase left speaker volume and decrease right speaker volume | To increase right speaker volume and decrease left speaker volume |
| VOL | Volume control | For less volume | For more volume |

▼ FM/AM selection button (FM/AM)

Push the "FM/AM" button ③ when the radio is on to select FM1, FM2 or AM reception. Each time this button is pressed, the band will change in the following order:



The display indicates which one is currently selected.

▼ Stereo indicator

The stereo indicator "ST" will come on when an FM stereo broadcast is received.

▼ Manual tuning (TUNING)

Press the tuning button ① marked "∧" to increase the tuning frequency and press the tuning button marked "∨" to decrease it.

Each time the button is pressed, the frequency changes 10 kHz in the AM mode and 0.2 MHz in the FM mode.

Constant pressure on the button causes a continuous change in the frequency.

▼ Automatic tuning (SCAN)

Press the "SCAN" button ② to change the radio to the SCAN mode. In this mode, the radio scans through the radio band until a station is found. The radio will stop at the station for five seconds while displaying the frequency, after which scanning will continue until the entire band has been scanned from the low end to the high end.

Press the "SCAN" button again to cancel the SCAN mode and to stop on any displayed frequency.

When the "SCAN" button is pressed for automatic tuning, stations are scanned in the direction of low frequencies to high frequencies only.

Automatic tuning may not function properly if the station reception is weakened by distance from the station or proximity to tall buildings and hills.

▼ Selecting preset stations

Presetting a station with a preset button ④ allows you to select that station in a single operation. Up to six AM, FM1 and FM2 stations each may be preset.

▼ How to preset stations

1. Press the "FM/AM" selection button ③ to select FM1, FM2 or AM reception.
2. Press the "SCAN" button ② or tune the radio manually until the desired station frequency is displayed.
3. Press one of the preset buttons ④ for **at least two seconds** to store the frequency. The frequency of the station will flash once on the display at this time. If the button is pressed for less than two seconds, the preceding selection will remain in memory.

NOTE

If the connection between the radio and battery is broken for any reason such as vehicle maintenance or radio removal, all stations stored in the preset buttons are cleared. If this occurs, it is necessary to reset the preset buttons.

Cassette player operation

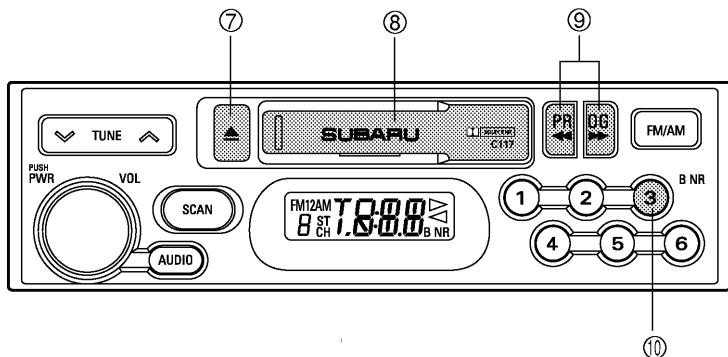

HB5043CB

- ⑦ Eject button
- ⑧ Cassette slot
- ⑨ Fast-forward/Rewind button
(Program switching buttons)
- ⑩ Dolby B NR button

NOTE

- Only use good quality cassettes (cassettes longer than C-90 are not recommended).
- Put cassettes back in their boxes immediately after use to protect them from dust and dirt and to prevent the tape from unwinding.
- Never expose cassettes to heat, direct sunlight or moisture.
- Clean the tape head (once or twice a month) using a *wet-type cleaning cassette*.

▼ Cassette slot

Insert a cassette with the exposed tape side facing to the right. After inserting, playback starts.

▼ Tape travel indicators

The tape travel indicators indicate the direction the cassette tape is moving.

– CONTINUED –

-
- ▶ : Indicates that the top side of the cassette is being played back.
- ◀ : Indicates that the bottom side of the cassette is being played back.

▼ Program switching buttons

When the program switching buttons "◀◀" and "▶▶" ⑨, are pressed at the same time during playback, the tape travel indicators will switch and the player will begin playing back the opposite side of the tape. The same mechanism is automatically activated when the end of the tape is reached. This allows the opposite side of the tape to play, providing continuous playback.

▼ Fast-forward button

To fast-forward the tape, press the "◀◀" or "▶▶" button ⑨ in the same direction as the tape travel indicator. To stop fast-forwarding, lightly press the opposite side of the "◀◀" or "▶▶" button.

▼ Rewind button

To rewind the tape, press the "◀◀" or "▶▶" button ⑨ in the direction opposite to the tape travel indicator. To stop rewinding, lightly press the opposite side of the "◀◀" or "▶▶" button.

▼ Eject button (▲)

When the "▲" button ⑦ is pressed, playback stops and the cassette tape is ejected.

Before the ignition switch is turned to the "OFF" position, eject the tape from the player. Always make certain that you remove the cassette tape.

▼ Dolby BNR button (BNR)

Press "BNR" button ⑩ when playing tapes recorded using the Dolby NR system*. The "BNR" indicator will light up and high-frequency noise on the tape will be reduced for clearer sound reproduction.

* Noise reduction system manufactured under license from Dolby Laboratories Licensing Corporation. "Dolby" and the double-D Symbol are trade marks of Dolby Laboratories Licensing Corporation.

CD player operation (if optional CD player is connected)

An optional CD player can be connected to this audio unit. See your SUBARU dealer for more information. For CD player operation procedures, refer to "CD player 2" in this chapter.

CD player 1 (if equipped)

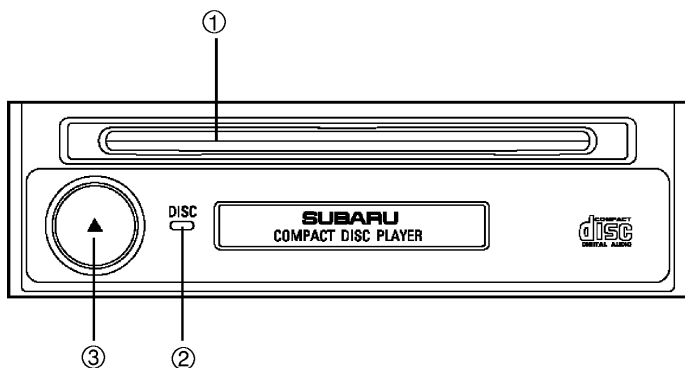

HB5039BB

- ① Disc slot
- ② Disc indicator

- ③ Eject button

CAUTION

- Use only music CDs identified by  mark.
- Do not use CDs listed below which could cause damage to the CD player.
 - Any disc with a peel-off or seal on it.
 - Any disc with scratches and/or dust.
 - Bent disc.
 - Cleaning disc.
 - CD accessory. (E.g., 3-inch (8 cm) disc adapter)
- Do not insert or remove any disc when the automatic transmission selector lever is in the park position; the selector lever in that position can interfere with disc insertion or removal, causing scratches on the disc surface (for AT vehicles).

▼ To insert a disc

Be sure to hold a disc with the label side (the side where titles are printed) up.

Push the disc into the slot.

The disc will be automatically set in position by the auto-loading mechanism and begin playing.

The disc indicator will turn on as the CD begins playing.

▽ Disc indicator

Lit: A disc is in the slot (When the ignition switch is in the "ON" or "ACC" position).

OFF: No disc is loaded or the ignition switch is in the "Lock" position.

▼ To remove disc left in slot

Simply press the "Eject button"  and the disc will be ejected. This procedure is effective even when the ignition switch is in the "LOCK" position.

▽ Function control

Refer to CD player control operating instructions described in the "Type P119 and P120 audio sets" section.

CD player 2 (if equipped)

Compact disc player operation

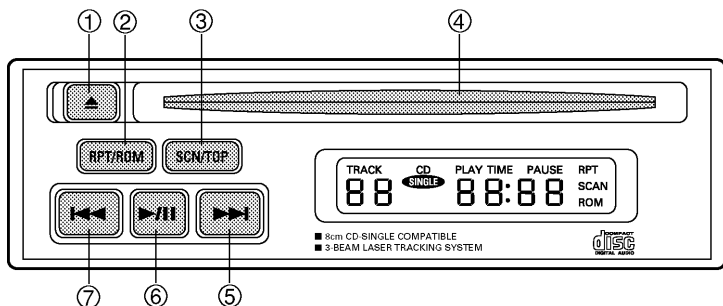

HB5044BB

- | | |
|------------------------|--------------------------------------|
| ① Eject button | ⑤ Fast forward and track up button |
| ② Repeat/random button | ⑥ Play/pause button |
| ③ Scan/top button | ⑦ Fast reverse and track down button |
| ④ Disc slot | |

▼ To playback a compact disc

▽ When CD is not in the player

Hold a disc with a finger in the center hole while gripping the edge of the disc, then insert it in to the slot (with the label side up) and the player will automatically pull the disc into position.

A 8 cm/3 inch CD may also be used without any adapter.

NOTE

- **DO NOT INSERT TWO DISCS INTO THE DISC INSERTION SLOT AT A TIME.**
- **Be sure to always insert a disc with the label side up. If a disc is inserted with the label side down, it might be ejected or the player might shut off.**
- **After the last song finishes, the player will automatically return to track 1 (the first song on the disc).**

– CONTINUED –

▽ **When CD is in the player**

When the "▶/||" button ⑥ is pressed, the player will start playback.

NOTE

After the last song finishes, the player will automatically return to track 1 (the first song on the disc).

▼ **To stop playback of a CD**

When the "▶/||" button ⑥ is pressed during playback of a CD, the CD stops playing temporarily. To let the CD resume playing, press the button again.

▼ **To select a song from its beginning**

▽ **Forward direction**

Briefly press the "▶▶" button ⑤ to skip to the beginning of the next track. Each time the button is pressed, the indicated track number will increase.

▽ **Backward direction**

Briefly press the "◀◀" button ⑦ to skip to the beginning of the current track. Each time the button is pressed, the indicated track number will decrease.

▼ **Fast forwarding and fast reverse**

▽ **Fast forward**

Press the "▶▶" button ⑤ continuously for more than 0.5 second to fast forward the disc.

Release the button to stop fast forwarding.

▽ **Fast reverse**

Press the "◀◀" button ⑦ continuously for more than 0.5 second to fast reverse the disc.

Release the button to stop fast reverse.

▼ **Repeat playback**

Use this to play a certain track repeatedly. During playback, press the "RPT/RDM" button ② and release it in less than 2 seconds. The "RPT" indicator will come on and the song will be played continuously. To

cancel the repeat mode, press the button again. Then the "RPT" indicator goes out, and normal playback mode is restored.

▼ Random playback

Use this to play the tracks on the disc in random order. During playback, press the "RPT/RDM" button ② and hold it in for more than 2 seconds. The "RDM" indicator will come on and all songs on the disc will be played in a random order.

To cancel the random mode, press the button again. Then the "RDM" indicator goes out, and normal playback mode is restored.

▼ Scan

Press the "SCN/TOP" button ③ and release it in less than 2 seconds, and you can hear the first 10 seconds of each track to search for the desired program. To continue listening to the program, press the "SCAN" button again. After all tracks on the disc has been scanned, normal playback mode is restored.

▼ Top

Use this to return to the first track on the disc during playback. Press the "SCN/TOP" button ③ and hold it in for more than 2 seconds. Playback returns to the beginning of the first track on the disc.

▼ To eject a disc from the player

When a disc is being played back or when a disc is in the player, press the eject button "▲". The disc will be ejected.

The disc may be removed even when the ignition switch is in the "LOCK" position.

NOTE

- **Avoid driving the vehicle with a CD sticking out, because vibration might make it fall out.**
- **To protect the disc, the disc is automatically loaded if it is left in the ejected position for more than approximately 15 seconds (Auto Reload). In this case, the disc is not played.**

In-dash 6 CD auto changer (if equipped)

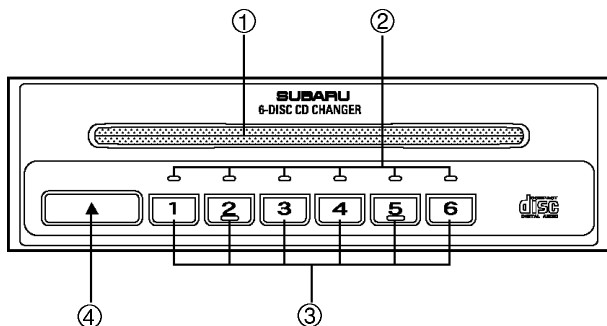

HB5040BB

- ① Disc slot
- ② Disc indicators (disc No.1 to 6)
- ③ Disc select buttons (disc No.1 to 6)
- ④ Eject button

CAUTION

- Do not attempt to insert two or more discs into the slot at a time. Doing so can cause mechanical damage to the CD changer.
- Use only music CDs identified by a  mark.
- Do not use CDs listed below which could cause damage to the CD player.
 - 3-inch (8 cm) compact disc.
 - Any disc with a peel-off or seal on it.
 - Any disc with scratches and/or dust.
 - Bent disc.
 - Cleaning disc.
 - CD accessory. (E.g., 3-inch (8 cm) disc adapter)
- Do not insert or remove any disc when the automatic transmission selector lever is in the park position; the selector lever in that position can interfere with disc insertion or removal, causing scratches on the disc surface (for AT vehicles).

▼ To insert a disc

1. Press one of the "Disc select" buttons ③ (numbered from 1 to 6) for which the disc indicator light ② is "OFF".

The Disc indicator lights are located directly above the corresponding "Disc select" buttons.

2. The indicator will begin blinking. The blinking will last for 15 seconds.

During this period, insert a desired disc, and the disc will begin to play. (If any disc is not inserted during this period, the "Disc slot" ① door will close. Repeat step 1.)

Be sure to hold a disc with the label side (the side where titles are printed) up.

3. To insert another disc, repeat step 1 and 2 choosing a different disc select button.

▼ To insert six discs at a time

1. Press and hold the "Disc select" button number 1 until all disc indicators begin blinking (about 1.5 seconds).

2. The indicators will blink for 15 seconds. During this period, insert desired six discs.

3. When all discs are loaded, the first disc will begin to play. (If no disc is inserted within this 15 seconds, the entire disc load sequence will be canceled.)

▼ To remove a disc

1. Press the desired one of the "Disc select" buttons ③ (numbered from 1 to 6) for which the disc indicator light is on.

2. Press the "Eject button" ④. The selected disc will be ejected and the indicator light will begin blinking.

3. To remove another disc, repeat step 1 and 2 choosing a different "Disc select" button.

(To remove discs when the ignition switch is in the "Lock" position, press the "Eject" button, and the first disc will be ejected. Press the "Eject" button again, and the next disc will be ejected and so on. At this time, the "Disc select" buttons are disabled.)

▼ To remove all discs at one time

1. Press and hold the "Eject" button ④ until all "Disc" indicators begin blinking (about 1.5 seconds), and the first disc will be ejected.
2. When the disc is removed, the next one will be ejected, and so on.

▼ To replace a playing disc with another

Simply press the desired one of "Disc select" buttons ③ (numbered from 1 to 6) or press the "DISC UP" or "DISC DOWN" button on the radio unit to select the desired disc, and the disc will begin to play.

▼ Disc indicators

Lit: when the corresponding storage tray is occupied by a disc.

Blinking: Disc player is either in loading, eject or changing mode.

OFF: No disc is loaded or the ignition switch is in the "LOCK" position.

▼ Function control

Refer to CD player control operating instructions described in the "Type P119 and P120 audio sets" or "Type P121 audio set" section.

Precautions to observe when handling a compact disc (CD)

- To remove a disc from the case, press the center of the case and hold both edges of the disc. If the disc surface is touched directly, contamination could cause poor tone quality. Do not touch the disc surface.
- Use a clean disc whenever possible. If there are deposits, wipe the disc surface from the center outward with a dry, soft cloth. Be sure not to use a hard cloth, thinner, benzene, alcohol, etc.
- Never use a badly damaged, deformed or cracked disc. Malfunctions or problems might result.
- A disc is vulnerable to heat. Never keep it either in places exposed to direct sunlight, near heaters or in vehicles parked in the sun or hot days.

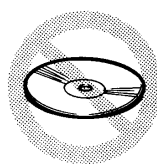
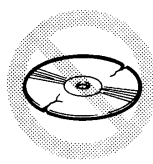
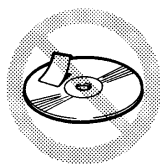
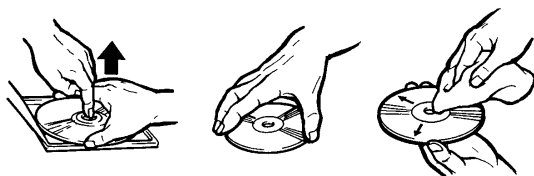

OM-4747