

4-4 [M6A0]**MECHANISM AND FUNCTION****6. Anti-lock Brake System (ABS)****6. Anti-lock Brake System (ABS)****A: FEATURE**

- This ABS 5.3i type incorporates the hydraulic control unit, ABS control module, valve relay and motor relay in one unit for better productivity and lightweight.
- The ABS (Anti-lock brake system) electrically controls brake fluid pressure to prevent wheel "lock" during braking on slippery road surfaces, thereby improving directional/steering stability.
- If the ABS becomes inoperative, the fail-safe system activates to ensure it acts as a conventional brake system. The warning light also comes on to indicate that the ABS is malfunctioning.
- The front-and-rear wheels utilize a 4-sensor, 4-channel control design: the front wheels have an independent control design*¹ and the rear wheels have a select low control design*².

*1: A system which independently controls fluid pressure to left and right front wheels.

*2: A system which provides the same fluid pressure control for the two rear wheels if either wheel starts to "lock."

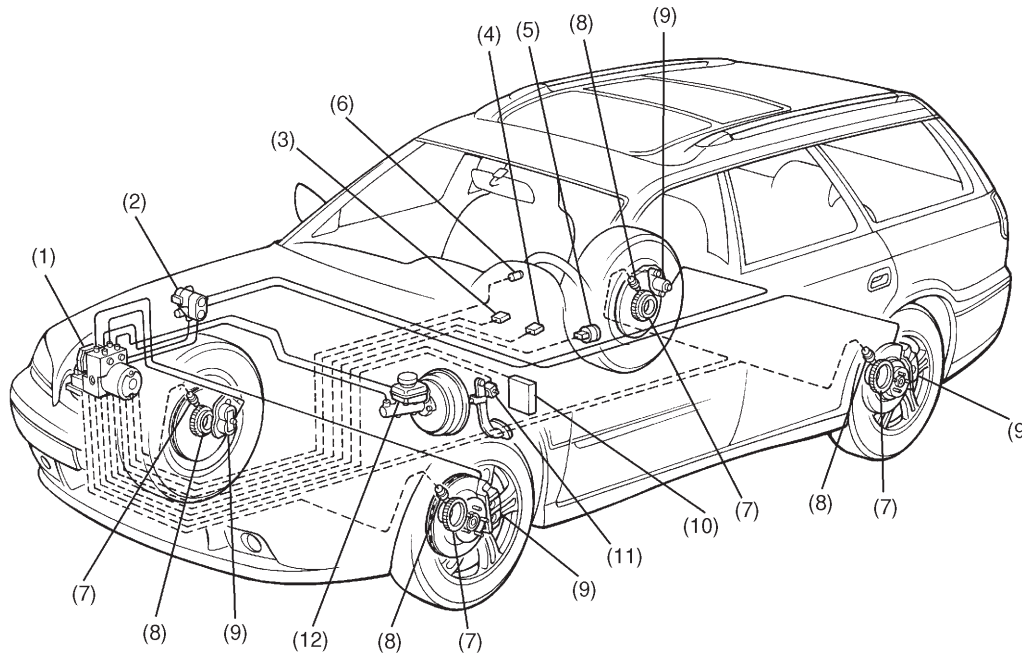

B4H2196A

- | | | |
|---|-----------------------|--|
| (1) ABS control module and hydraulic control unit (ABSCM & H/U) | (5) G sensor | (9) Wheel cylinder |
| (2) Proportioning valve | (6) ABS warning light | (10) Transmission control module (only AT vehicle) |
| (3) Diagnosis connector | (7) Tone wheel | (11) Brake switch |
| (4) Data link connector (for SUBARU select monitor) | (8) ABS sensor | (12) Master cylinder |

MECHANISM AND FUNCTION**[M6B0] 4-4**

6. Anti-lock Brake System (ABS)

B: FUNCTIONS OF SENSORS AND ACTUATORS

| Name | | Function |
|---|---------------------|---|
| ABS control module and hydraulic control unit (ABSCM & H/U) | ABSCM-section | <ul style="list-style-type: none"> Calculates to determine the conditions of the wheels and body from the wheel speeds and makes a proper decision suitable for the current situation to control the hydraulic unit. In the ABS operation mode, the module outputs a cooperative control signal to the AT control module. (AT vehicles only) Whenever the ignition switch is placed at ON, the module makes a self diagnosis. When anything wrong is detected, the module cuts off the system. Communicates with the Subaru select monitor. |
| | H/U-section | <p>In the ABS operation mode, the H/U changes fluid passages to control the fluid pressure of the wheel cylinders in response to an instruction from the ABSCM.</p> <p>The H/U also constitutes the brake fluid passage from the master cylinder to the wheel cylinders together with pipings.</p> |
| | Valve relay-section | Serves as a power switch for the solenoid valve and motor relay coil in response to an instruction from the ABSCM. |
| | Motor relay-section | Serves as a power switch for the pump motor in response to an instruction from the ABSCM. |
| Wheel speed sensor (ABS sensor) | | Detects the wheel speed in terms of a change in the magnetic flux density passing through the sensor, converts it into an electrical signal, and outputs the electrical signal to the ABSCM. |
| Tone wheel | | Gives a change in the magnetic flux density by the teeth around the tone wheel to let the ABS sensor generate an electrical signal. |
| G sensor | | Detects a change in G in the longitudinal direction of the vehicle and outputs it to the ABSCM in terms of a change in voltage. |
| Stop light switch | | Transmits the information on whether the brake pedal is depressed or not to the ABSCM for use as a condition in determining ABS operation. |
| ABS warning light | | Alerts the driver to an ABS fault. When the diagnosis connector and diagnosis terminal are connected, the light flashes to indicate a trouble codes in response to an instruction from the ABSCM. |
| AT control module (TCM) (AT vehicles only) | | Provides shift controls (fixing the speed at 3rd or changing front and rear wheel transmission characteristics) in response to an instruction from the ABSCM. |

4-4 [M6B0]

MECHANISM AND FUNCTION

6. Anti-lock Brake System (ABS)

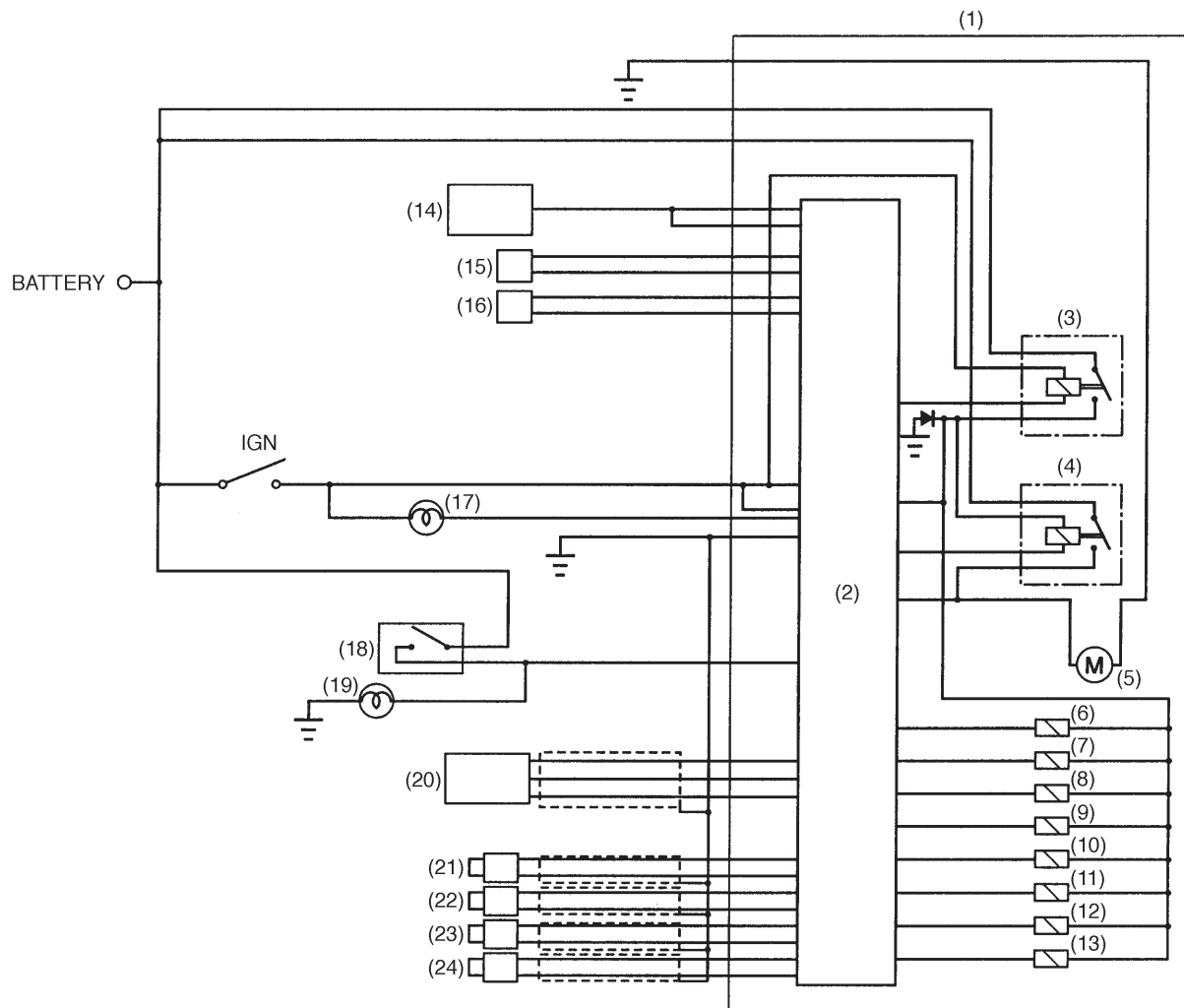

S4H0019A

- | | | |
|---|---|-----------------------------|
| (1) ABS control module and hydraulic control unit | (9) Front right outlet solenoid valve | (17) ABS warning light |
| (2) ABS control module section | (10) Rear left inlet solenoid valve | (18) Stop light switch |
| (3) Valve relay | (11) Rear left outlet solenoid valve | (19) Stop light |
| (4) Motor relay | (12) Rear right inlet solenoid valve | (20) G sensor |
| (5) Motor | (13) Rear right outlet solenoid valve | (21) Front left ABS sensor |
| (6) Front left inlet solenoid valve | (14) Transmission control module (only AT module) | (22) Front right ABS sensor |
| (7) Front left outlet solenoid valve | (15) Diagnosis connector | (23) Rear left ABS sensor |
| (8) Front right inlet solenoid valve | (16) Data link connector | (24) Rear right ABS sensor |

C: THEORY OF ABS CONTROL

When the brake pedal is depressed during operation, wheel speed as well as vehicle speed decreases. The difference which occurs between wheel speed and vehicle speed is called the "slip" phenomenon. The magnitude of this action is expressed by "slip" the ratio of which is determined by the following equation:

$$\text{Slip ratio} = \frac{\text{Vehicle speed} - \text{Wheel speed}}{\text{Vehicle speed}} \times 100 \%$$

When the "slip" ratio is 0 % vehicle speed equals wheel speed and the wheel rotates without any slippage. When the "slip" is 100 % the wheel locks and does not rotate (wheel speed = 0) although vehicle speed exists.

The relationship between the frictional force of a wheel in the fore-and-aft direction and the "slip" ratio is shown by two characteristic curves in figure.

These curves are determined by the relationship between the wheel and road surface. Where the same type of wheel are used; the curve shown by a solid line indicates wheels driven on asphalt or paved roads, the curve shown by dotted lines refers wheels subjected to slippery (snowy or icy) roads.

When different types of wheels are used, although the road surface is the same, these curves will change. In general, the frictional coefficient between wheel and road surface in relation to an increase in the "slip ratio" will reach the maximum value in the 8 – 30 % range and will tend to decrease after that.

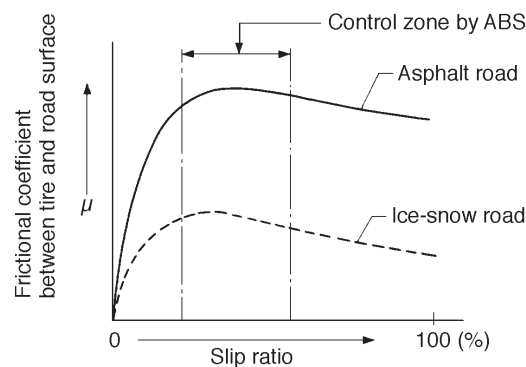

G4H0064

4-4 [M6D0]**MECHANISM AND FUNCTION****6. Anti-lock Brake System (ABS)****D: ABS SENSOR**

The ABS sensor detects wheel speed and consists of a permanent magnet, coil, tone wheel, etc. The magnetic flux produced by the permanent magnet varies with the tone wheel (which rotates together with the wheel) and the sensor emits an alternating voltage corresponding with the wheel speed by electromagnetic induction.

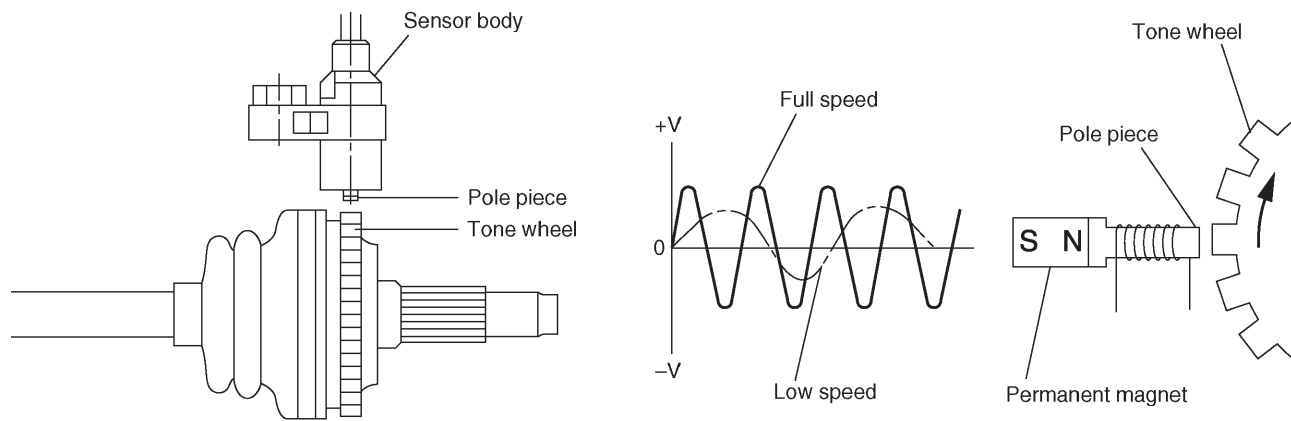

B4H2197A

E: ABS CONTROL MODULE AND HYDRAULIC CONTROL UNIT (ABSCM&H/U)**● ABS CONTROL MODULE SECTION (ABSCM)**

The ABSCM is a digital control type electronic control module accommodating two microcontrol modules (MCMs); master and slave. Both MCMs process the same program and monitor the respective outputs, and when a mismatch occurs, cut off the system to activate the fail-safe function.

A maximum of 3 trouble codes are stored in the EEPROM and if 3 or more areas fail, then only the 3 most recent failures are stored. The trouble codes remain stored until they are erased.

This ABSCM induces a sequence control pattern and facilitates the checking of the hydraulic unit.

● ABS control

Based on the four wheel speed signals, the ABSCM calculates a simulated body speed or body deceleration rate, while referencing the G sensor output as an auxiliary means, and compares them with the wheel speeds and wheel deceleration rates. If it determines that the wheels are about to lock, it controls the solenoid valve or motor pump of the H/U to adjust the brake fluid pressures that act on the wheel cylinders, thereby preventing the wheels from locking.

The ABSCM controls the right and left front wheel fluid pressures independently and controls the rear wheel fluid pressures on the basis of the wheel which is more likely to lock (Select-low control).

● Select monitor associated functions

The Subaru select monitor may be used to perform the following operations.

- To read out analog data
- To read out ON/OFF data
- To read out or erase trouble code
- To read out status information in the event of trouble (Freeze frame data)
- To initiate ABS sequence control pattern

● Indication functions

The ABS warning light can be made to indicate the following three states.

- ABS trouble
- Flashes to indicate trouble codes in diagnosis mode.
- Valve ON/OFF when sequence control pattern is in effect

4-4 [M6E0]**MECHANISM AND FUNCTION****6. Anti-lock Brake System (ABS)**

● HYDRAULIC CONTROL UNIT SECTION (H/U)

The H/U is a fluid pressure controller comprising a motor, solenoid valve, housing, relay, etc. It constitutes two diagonally independent brake fluid circuits for a cross piping vehicle.

- The pump motor rotates an eccentric cam to let the plunger pump generate a hydraulic pressure.
- The housing accommodates the pump motor, solenoid valve, reservoir, etc., and also constitutes a brake fluid passage.
- The plunger pump is a hydraulic pump which drains off the brake fluid which, when the pressure is reduced, is discharged to the reservoir, and sends it toward the master cylinder.
- The solenoid valve is a 2-position type solenoid valve which switches the brake fluid passages between the wheel and master cylinder and reservoir sides in response to an instruction from the ABSCM.
- The inlet solenoid valve is duty-controlled to reduce brake fluid pulsation for lower ABS operation noise.
- The reservoir is a fluid chamber which temporarily stores the brake fluid to be discharged from the wheel cylinder when the pressure is reduced.
- The damper chamber suppresses the pulsation of the brake fluid which, when the pressure is reduced, is discharged from the plunger pump, thereby minimizing the kickbacks to the brake pedal.
- The valve relay controls the solenoid valve and motor relay energizing power supply in response to an instruction from the ABSCM. In normal (IG ON) condition, the relay is actuated to supply power to the solenoid valve and motor relay. When an error occurs in the system, the valve relay is forced to OFF to keep the fluid pressure circuit in the normal mode (normal brake mode).
- The motor relay supplies power to the pump motor to operate the plunger pump in response to an instruction from the ABSCM in the ABS control mode.

The H/U has four operating modes; normal mode (control OFF: normal brake mode), "increase", "hold" and "decrease" modes (control ON in all the three modes).

MECHANISM AND FUNCTION**[M6E1] 4-4**
6. Anti-lock Brake System (ABS)**1. DURING NORMAL BRAKING**

Since no current is supplied to the inlet and outlet solenoid valves, no solenoid valve attracting force is generated. So the valves remain stationary.

Accordingly, the inlet port of the inlet solenoid valve is in an opened state, whereas the outlet port of the outlet solenoid valve is in a closed state. So the fluid pressure of the master cylinder is transmitted to the wheel cylinder to produce a brake force in the wheel cylinder.

NOTE:

Explained with one wheel's control as an example

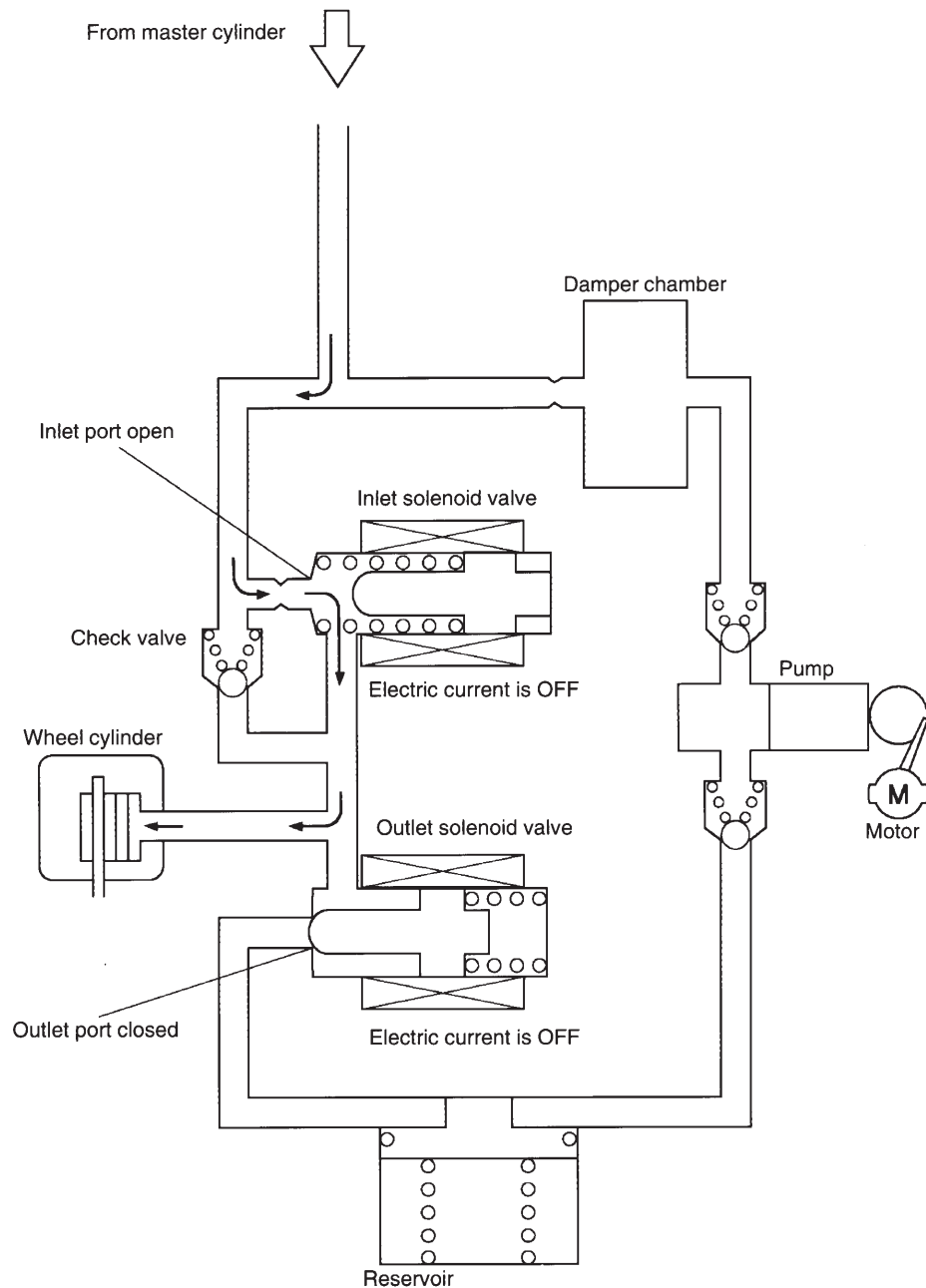

B4H0989

4-4 [M6E2]**MECHANISM AND FUNCTION****7. Anti-lock Brake System (ABS)****2. PRESSURE “DECREASE” ACTION WITH ABS IN OPERATION**

Current is supplied to the inlet and outlet solenoid valves, and the generated solenoid valve attracting forces close the inlet port and open the outlet port.

Accordingly, the wheel cylinder is isolated from the master cylinder and becomes clear to the reservoir, allowing the brake fluid to flow to the reservoir. So the fluid pressure of the wheel cylinder is decreased.

The brake fluid collected in the reservoir is fed to the master cylinder by the pump.

NOTE:

Explained with one wheel's control as an example

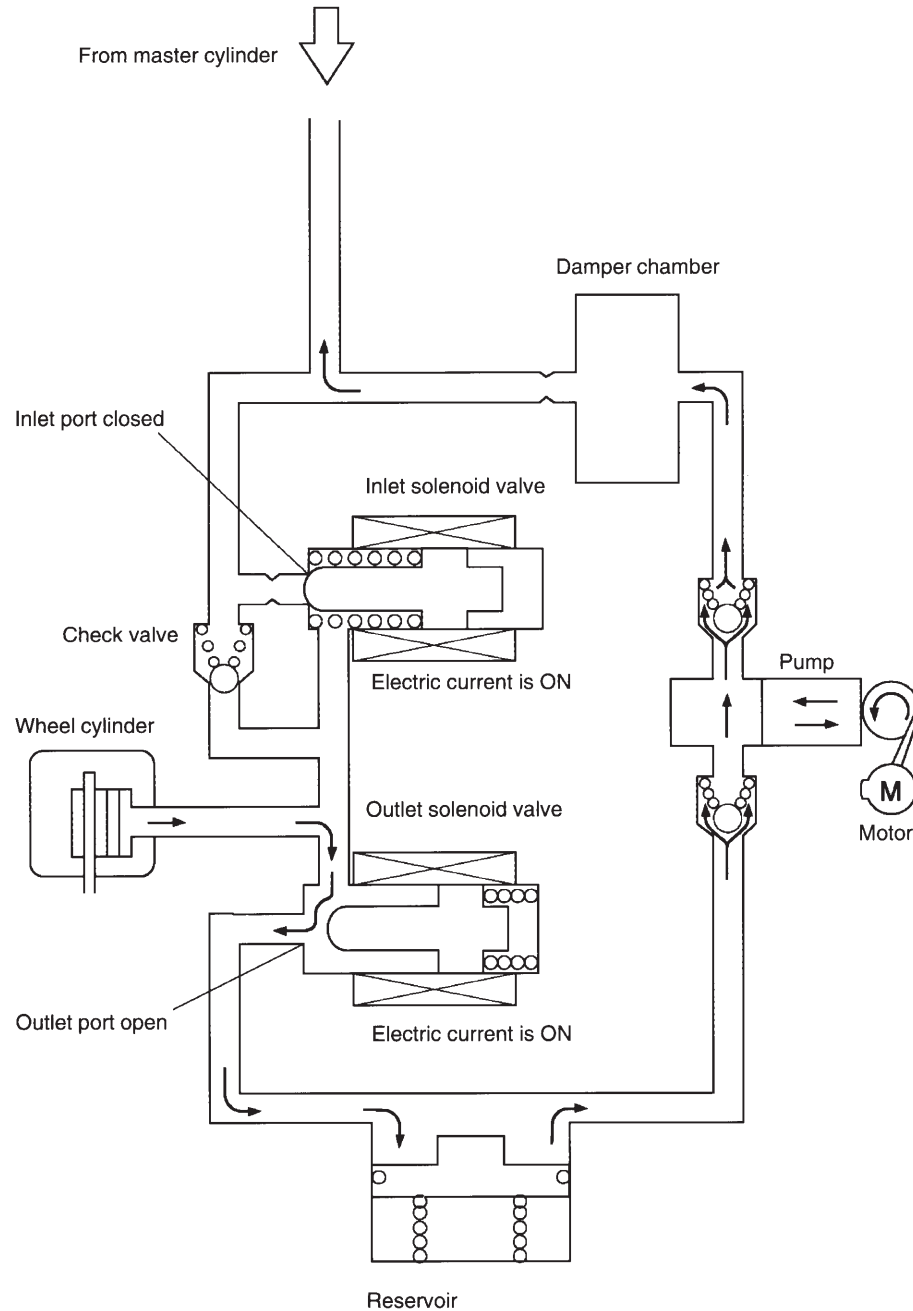

B4H0990

3. PRESSURE “HOLD” ACTION WITH ABS IN OPERATION

Current is supplied to the inlet solenoid valve, and the generated solenoid valve attracting force closes the inlet port.

Since no current is supplied to the outlet solenoid valve, the output port remains in a closed state. As a result, the wheel cylinder, master cylinder and reservoir are blocked, and the fluid pressure of the wheel cylinder is maintained constant.

During ABS operation, the pump motor continues to operate.

NOTE:

Explained with one wheel's control as an example

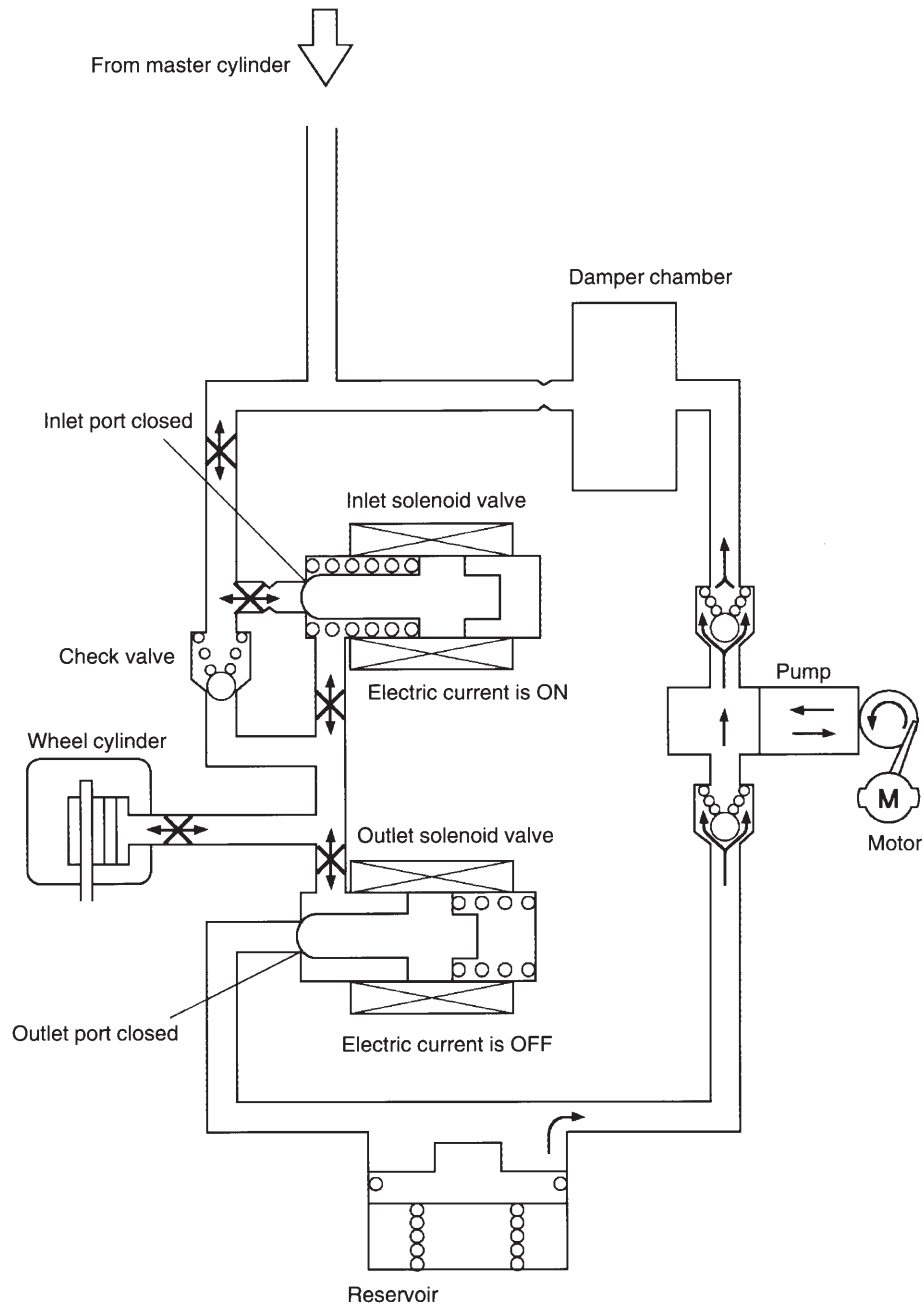

B4H0991

4-4 [M6E4]**MECHANISM AND FUNCTION****6. Anti-lock Brake System (ABS)****4. PRESSURE "INCREASE" ACTION WITH ABS IN OPERATION**

Since no current is supplied to the inlet and outlet solenoid valves, no solenoid valve attracting force is generated. So the valves remain stationary.

Accordingly, the inlet port of the inlet solenoid valve is in an opened state, whereas the outlet port of the outlet solenoid valve is in a closed state. So the fluid pressure of the master cylinder is transmitted to the wheel cylinder to increase the brake force in the wheel cylinder.

During ABS operation, the pump motor continues to operate.

NOTE:

Explained with one wheel's control as an example

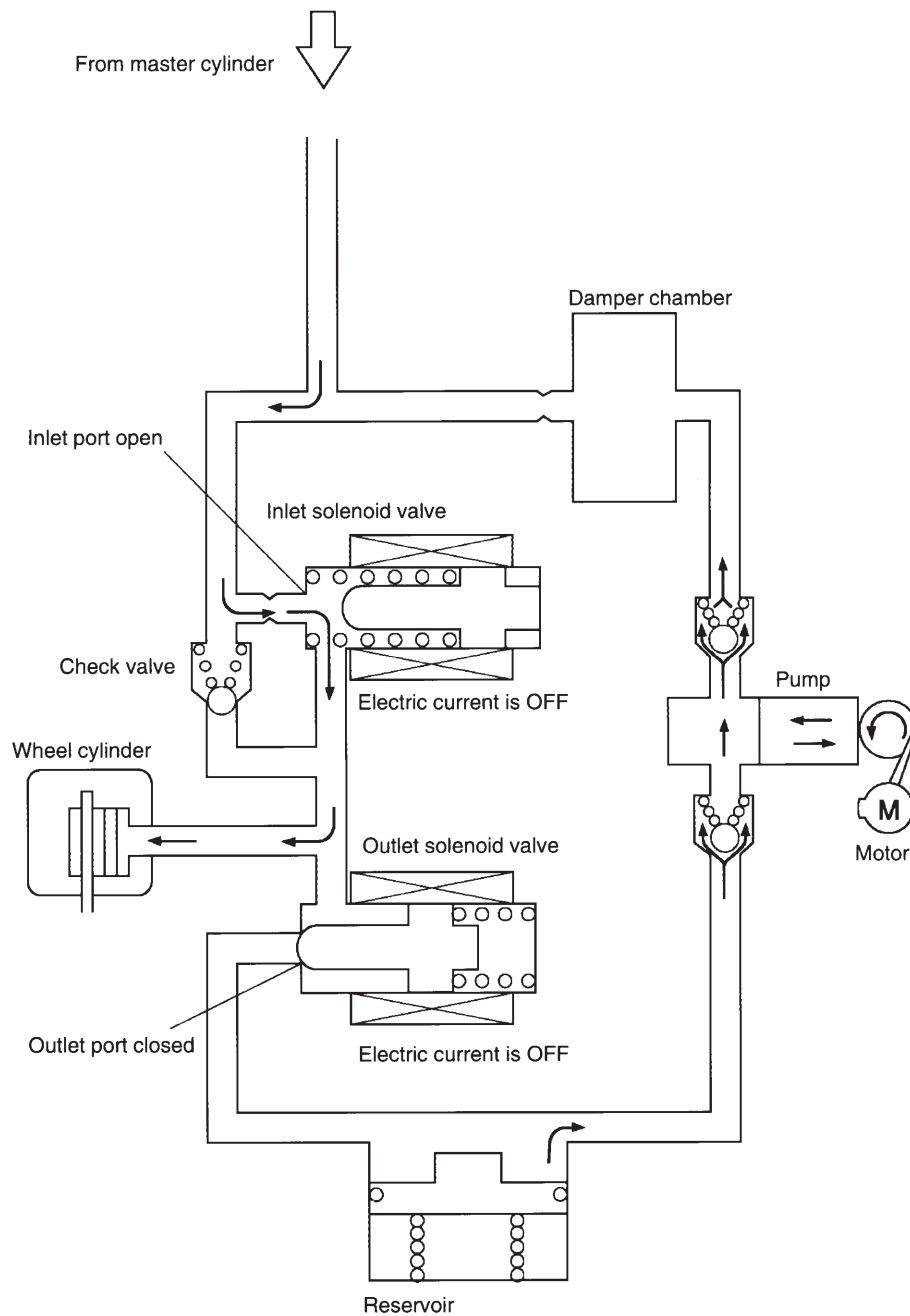

B4H0992

F: ABS CONTROL CYCLE CURVES

As the brake pedal is depressed, brake fluid pressure increases correspondingly, which in turn decreases wheel speed. When brake fluid pressure reaches point "A" (where wheel deceleration exceeds " $-b_0$ "), the control module transmits signal to hold the brake fluid pressure in wheel cylinder at that point. At the same time, the control module computes a "dummy" vehicle speed. When the wheel speed drops below the slip ratio setting (= speed less than the dummy vehicle speed based on the predetermined value) at point "B" of the brake fluid pressure, the control module then transmits signal to prevent wheel lock-up. This causes the brake fluid pressure to decrease.

After brake fluid pressure is decreased, wheel acceleration increases. When it exceeds the wheel acceleration setting " $+b_{10}$ " at point "C" (brake fluid pressure), the control module transmits signal to hold the brake fluid pressure at that point. When wheel acceleration setting value " $+b_{20}$ " is exceeded and when brake fluid pressure is at point "D", the control module judges that wheel lock-up will not occur and then transmits signal to increase brake fluid pressure.

When wheel acceleration drops below " $+b_{20}$ " (point "E") (which occurs due to a brake fluid pressure increase), signals are sent so that "holding pressure" and "increasing pressure" may be cycled in a given interval.

When wheel deceleration exceeds " $-b_0$ ", at point "F" of the brake fluid pressure, the control module immediately transmits signal to decrease brake fluid pressure.

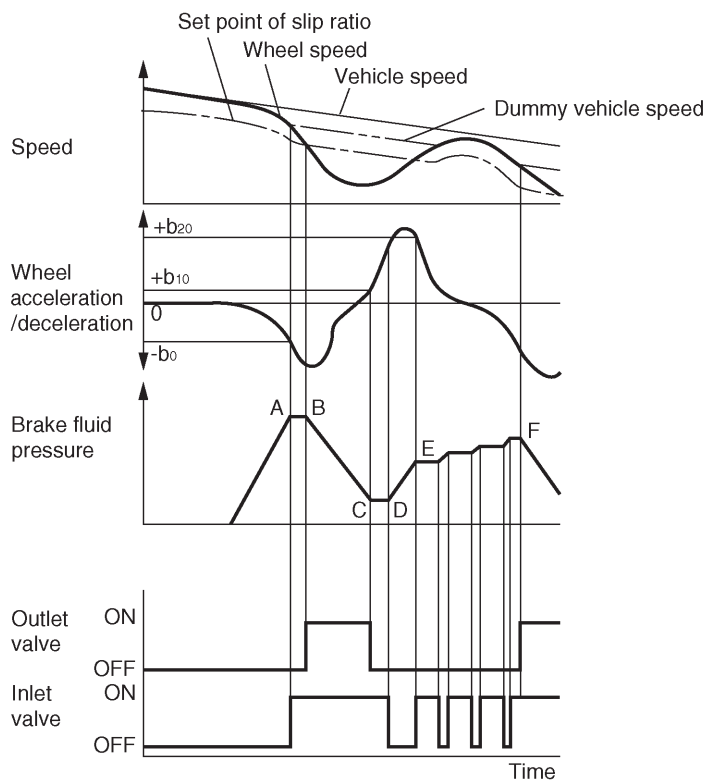

B4H2239A

| Brake fluid Pressure | Inlet valve | Outlet valve |
|----------------------|-------------|--------------|
| Increase | OFF | OFF |
| Hold | ON | OFF |
| Decrease | ON | ON |

4-4 [M6G0]**MECHANISM AND FUNCTION****6. Anti-lock Brake System (ABS)****G: ABS WARNING LIGHT**

When a signal system or the ABS control module becomes inoperative, the warning light in the combination meter comes on to indicate that the system or control module is malfunctioning. At the same time, current flowing through the hydraulic control unit is interrupted so that the brake system functions as a conventional brake system. The circuit through which the warning light comes on utilizes a dual system design.

If the warning light comes on upon detection of a system malfunction, call a trouble code and identify it using the warning light.

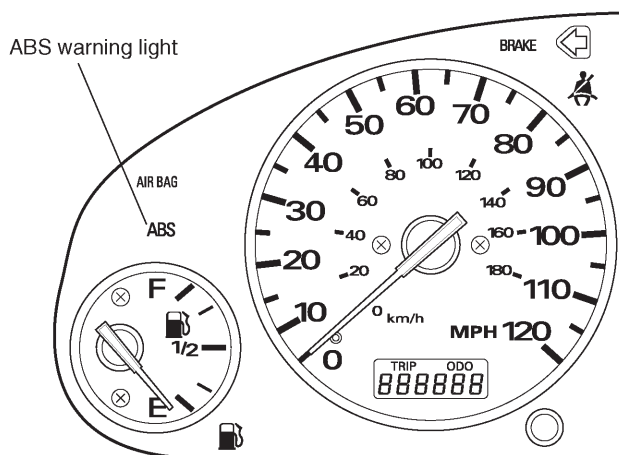
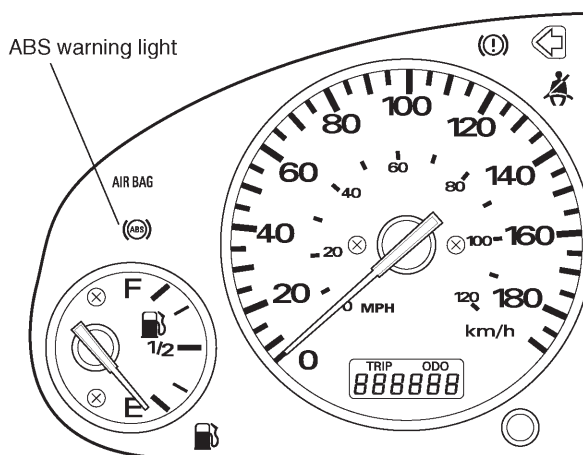
U.S spec. vehicle**Canada spec. vehicle**

B4H2198A

H: G SENSOR

The G sensor detects a change in G in the longitudinal direction. It detects the motion of the moving electrode built into the sensor in terms of a change in the capacitance of the capacitor and outputs it to the ABSCM in terms of a change in voltage.

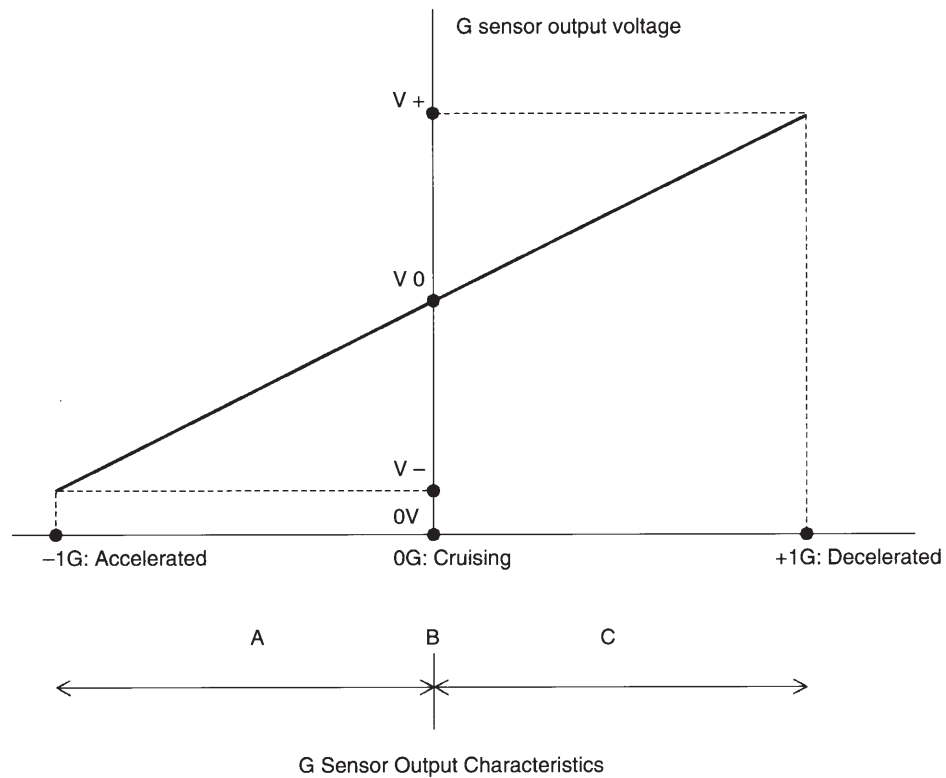
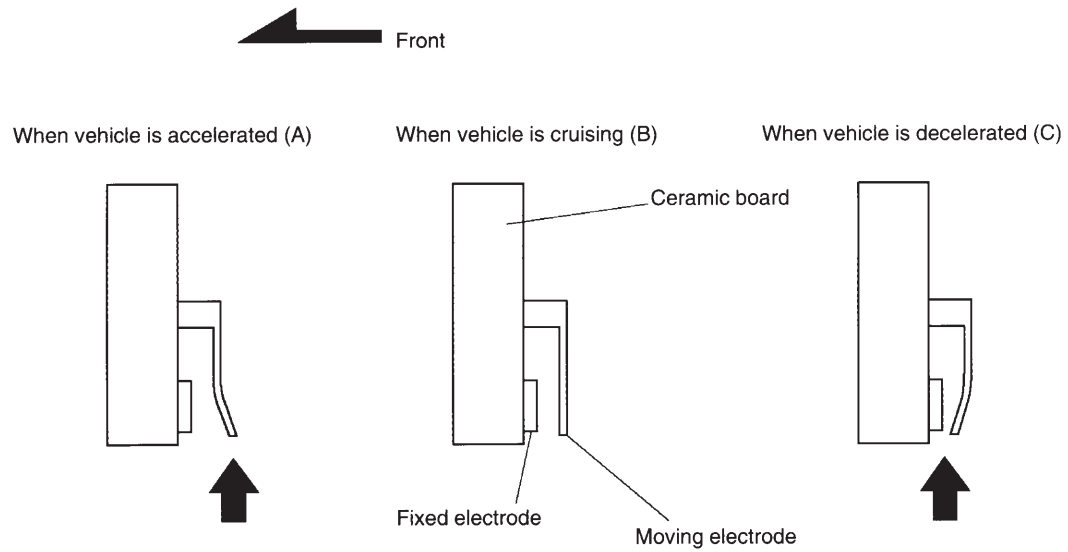

B4H0988