







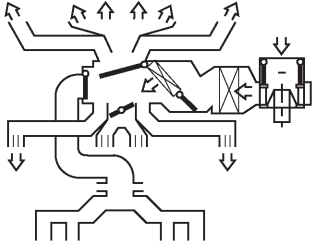

4-6 [M3A0]

MECHANISM AND FUNCTION

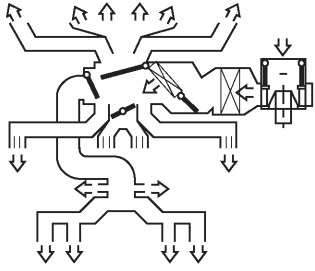
3. Mode Selector Switch and Air Flow

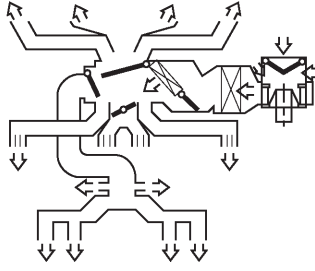
3. Mode Selector Switch and Air Flow

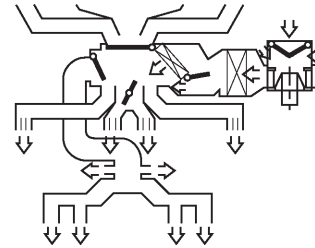
A: AIR FLOW

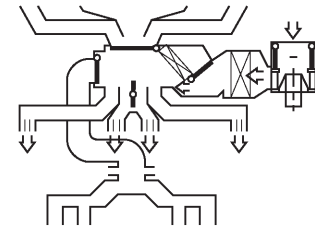
Mode selector switch position	Air flow
 <p>DEF</p>	
 <p>DEF/HEAT</p>	
 <p>HEAT</p>	
 <p>BI-LEVEL</p>	
 <p>VENT</p>	

B4H2241A

MECHANISM AND FUNCTION

[M3C0] 4-6

3. Mode Selector Switch and Air Flow

B: AIR DISTRIBUTION RATIO

Figure shows air distribution ratios corresponding to mode door position.

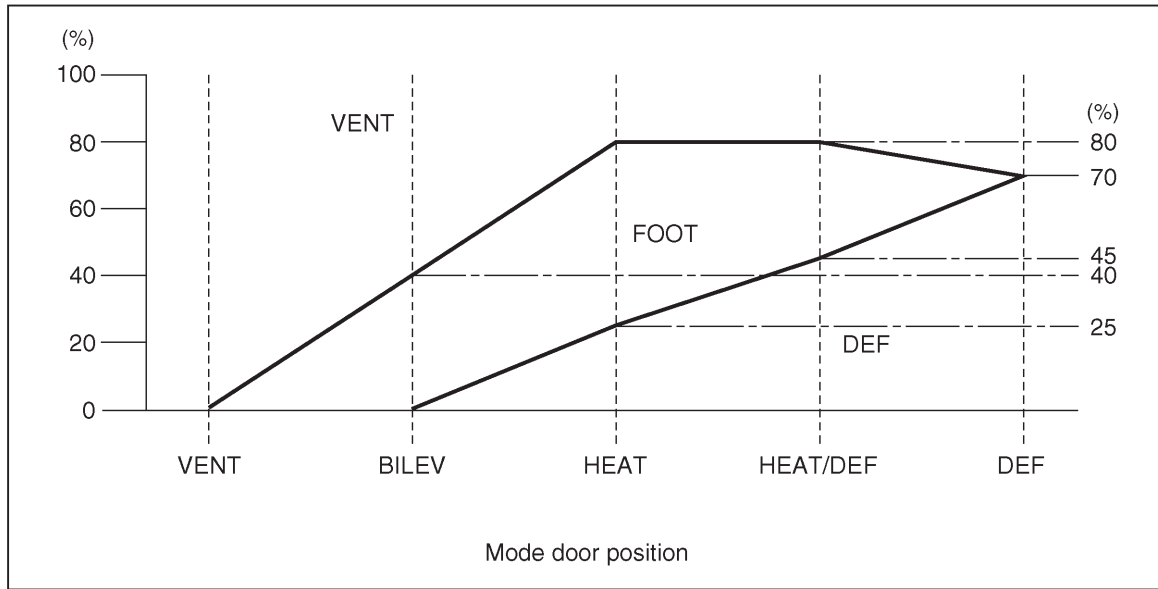

B4H1513B

C: SYSTEM FLOW

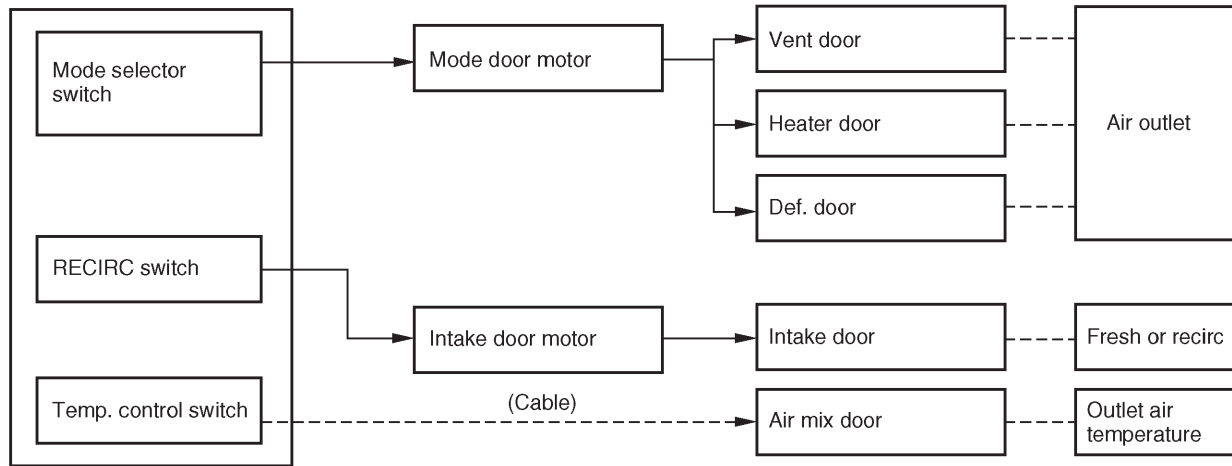

B4H0046A