

**SUPPLEMENT FOR 6 CYLINDER
ENGINE MODEL**

This service manual has been prepared to provide SUBARU service personnel with the necessary information and data for the correct maintenance and repair of SUBARU vehicles.

This manual includes the procedures for maintenance, disassembling, reassembling, inspection and adjustment of components and diagnostics for guidance of experienced mechanics.

Please peruse and utilize this manual fully to ensure complete repair work for satisfying our customers by keeping their vehicle in optimum condition. When replacement of parts during repair work is needed, be sure to use SUBARU genuine parts.

All information, illustration and specifications contained in this manual are based on the latest product information available at the time of publication approval.

FOREWORD**FW****HOW TO USE THIS MANUAL****HU****SPECIFICATIONS****SPC****PRECAUTION****PC****NOTE****NT****IDENTIFICATION****ID****RECOMMENDED MATERIALS****RM****PRE-DELIVERY INSPECTION****PI****PERIODICAL MAINTENANCE****PM**

**SUPPLEMENT FOR 6 CYLINDER
ENGINE MODEL****FUEL INJECTION (FUEL SYSTEMS) FU(H6)****EMISSION CONTROL
(AUX. EMISSION CONTROL DEVICES) EC(H6)****INTAKE (INDUCTION) IN(H6)****MECHANICAL ME(H6)****EXHAUST EX(H6)****COOLING CO(H6)****LUBRICATION LU(H6)****SPEED CONTROL SYSTEMS SP(H6)****IGNITION IG(H6)****START/CHARGING SYSTEMS SC(H6)****ENGINE (DIAGNOSTICS) EN(H6)****REAR SUSPENSION RS****WIRING SYSTEM WI**

WIRING SYSTEM



	Page
1. Basic Diagnostics Procedure	3
2. Working Precautions	13
3. Super Multiple Junction (SMJ)	14
4. Power Supply Routing.....	17
5. Ground Distribution	32
6. Airbag System	41
7. Air Conditioning System.....	45
8. Anti-lock Brake System.....	66
9. A/T Control System	73
10. Audio System	95
11. Charging System.....	100
12. Combination Meter.....	101
13. Cruise Control System	107
14. Door Lock System.....	120
15. Engine Coolant Temperature Gauge System	124
16. Engine Electrical System	125
17. Fuel Gauge System	181
18. Full-Time Dual-Range System	184
19. Front Accessory Power Supply System.....	185
20. Headlight Beam Leveler System.....	186
21. Horn System.....	187
22. Immobilizer System	188
23. Keyless Entry System	192
24. Back-up Light System	198
25. Clearance Light and Illumination Light System	199
26. Front Fog Light System.....	206
27. Headlight System	209
28. In Compartment Light System.....	211
29. Stop Light System	217
30. Turn Signal Light and Hazard Light System.....	219
31. Oil Pressure Warning Light System.....	223
32. Outside Temperature Display System.....	224
33. Parking Brake and Brake Fluid Level Warning System.....	225
34. Pneumatic (Air) Suspension System	226
35. Power Seat System.....	234
36. Power Window System	235
37. Radiator Fan System	244
38. Rear Accessory Power Supply System	247
39. Rear Fog Light System	248
40. Rear Window Defogger System.....	249
41. Remote Controlled Rearview Mirror System	250
42. Seat Belt Warning System	252
43. Seat Heater System.....	254
44. Starter System.....	255

GENERAL DIAGNOSTIC TABLE

45.	Sunroof System.....	256
46.	Vehicle Dynamic Control System.....	257
47.	Wiper and Washer System (Front)	273
48.	Wiper and Washer System (Rear).....	275
49.	Wiper Deicer System	277
50.	Overall Systems	278
51.	Front Wiring Harness	282
52.	Bulkhead Wiring Harness (In Engine Room).....	288
53.	Bulkhead Wiring Harness (In Compartment).....	296
54.	Engine Wiring Harness and Transmission Cord.....	305
55.	Instrument Panel Wiring Harness	309
56.	Rear Wiring Harness.....	313
57.	Door Cord.....	321
58.	Rear Wiring Harness and Trunk Lid Cord	325
59.	Rear Wiring Harness and Rear Gate Cord.....	327

16. Engine Electrical System S903482

A: SCHEMATIC S903482A21

1. LHD-H4 WITHOUT OBD MODEL S903482A2108

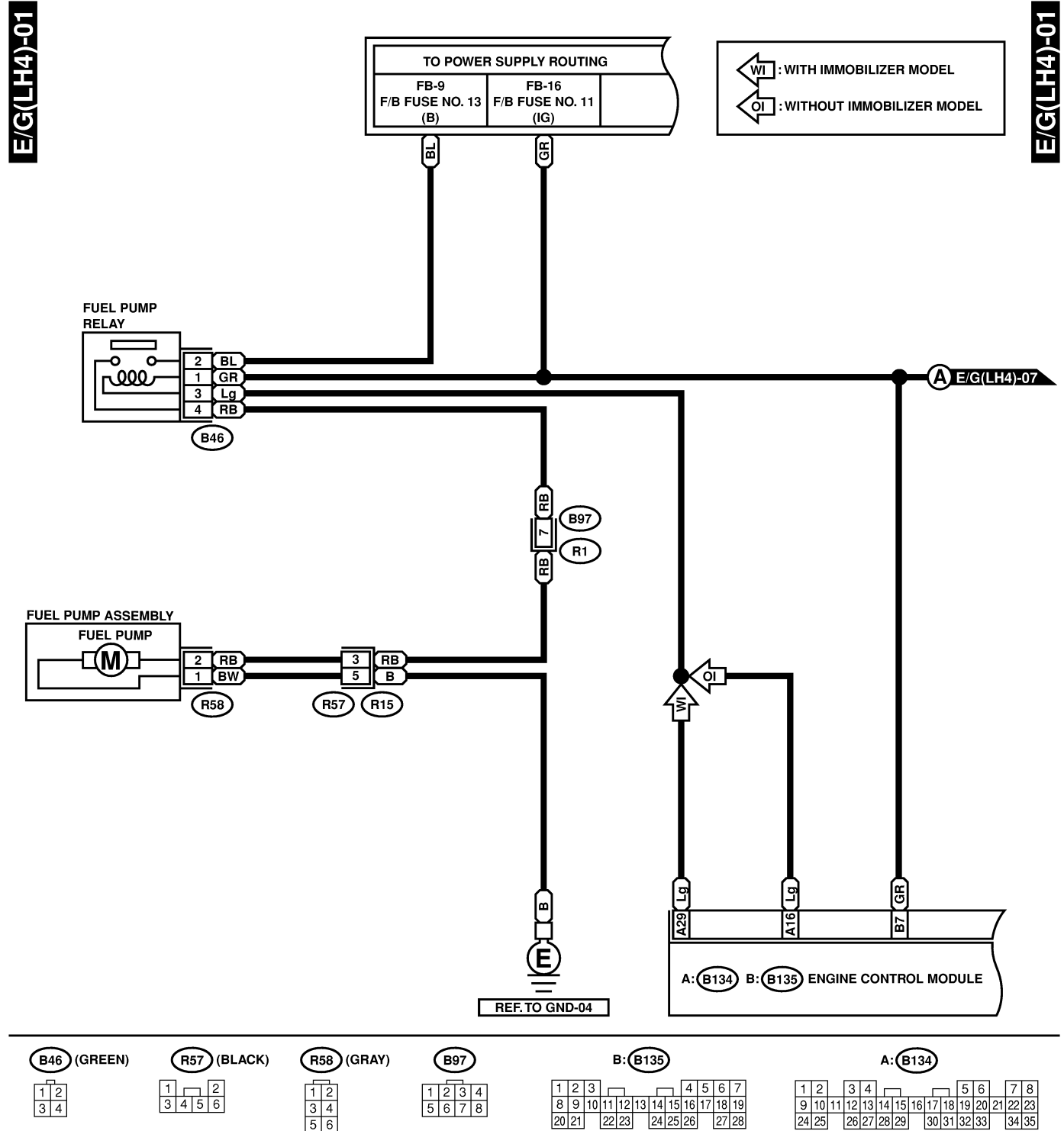

ENGINE ELECTRICAL SYSTEM

Wiring System

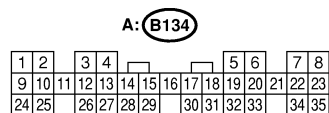
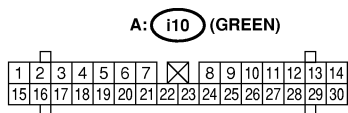
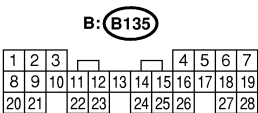
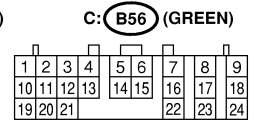
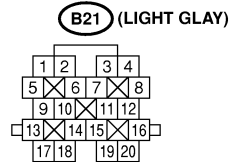
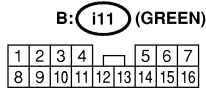
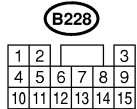
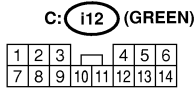
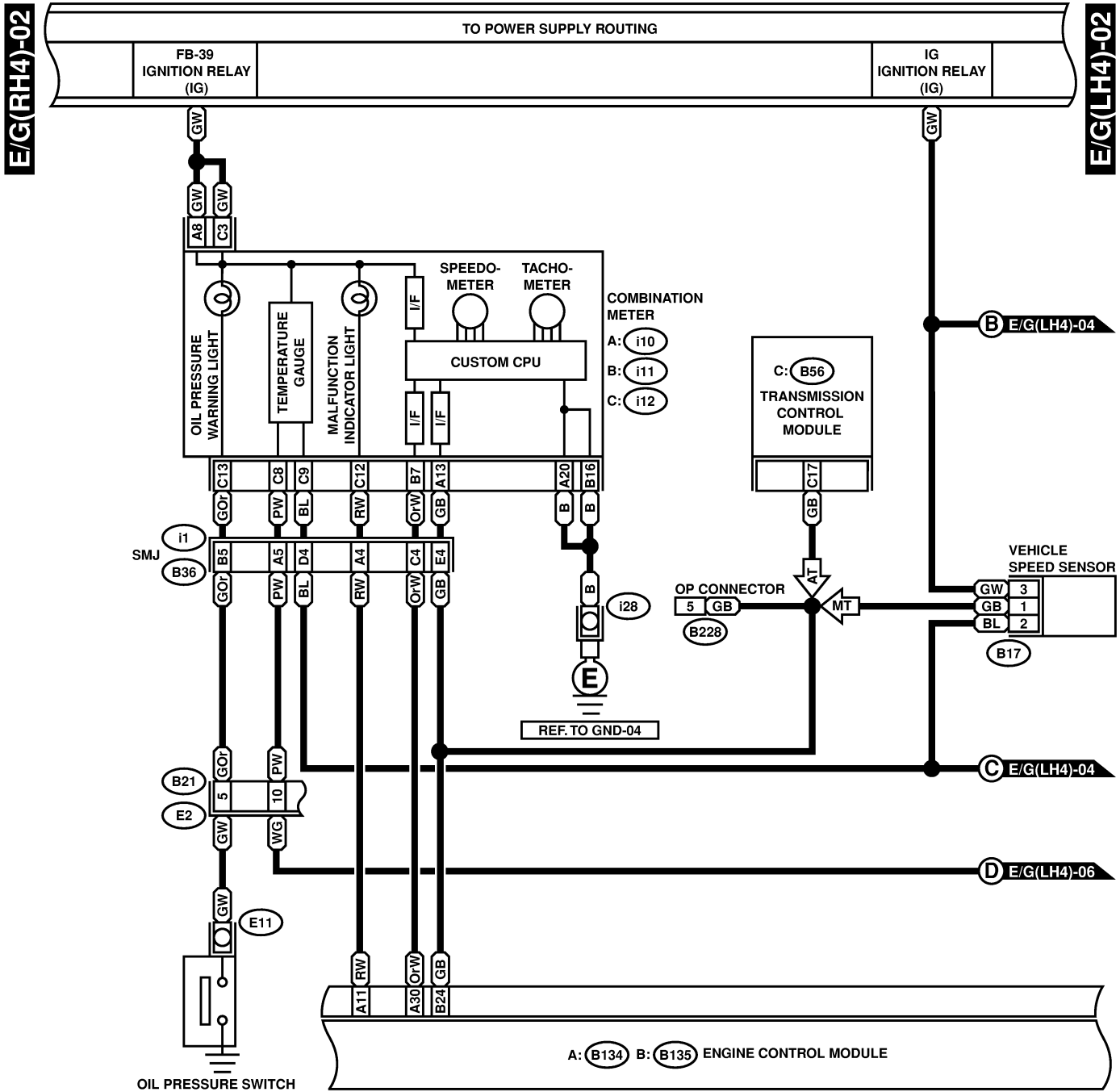

ENGINE ELECTRICAL SYSTEM

Wiring System

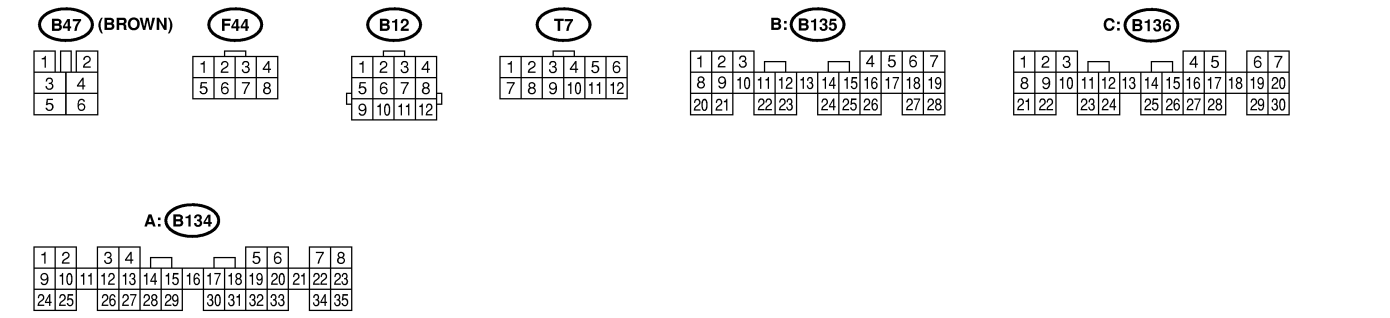
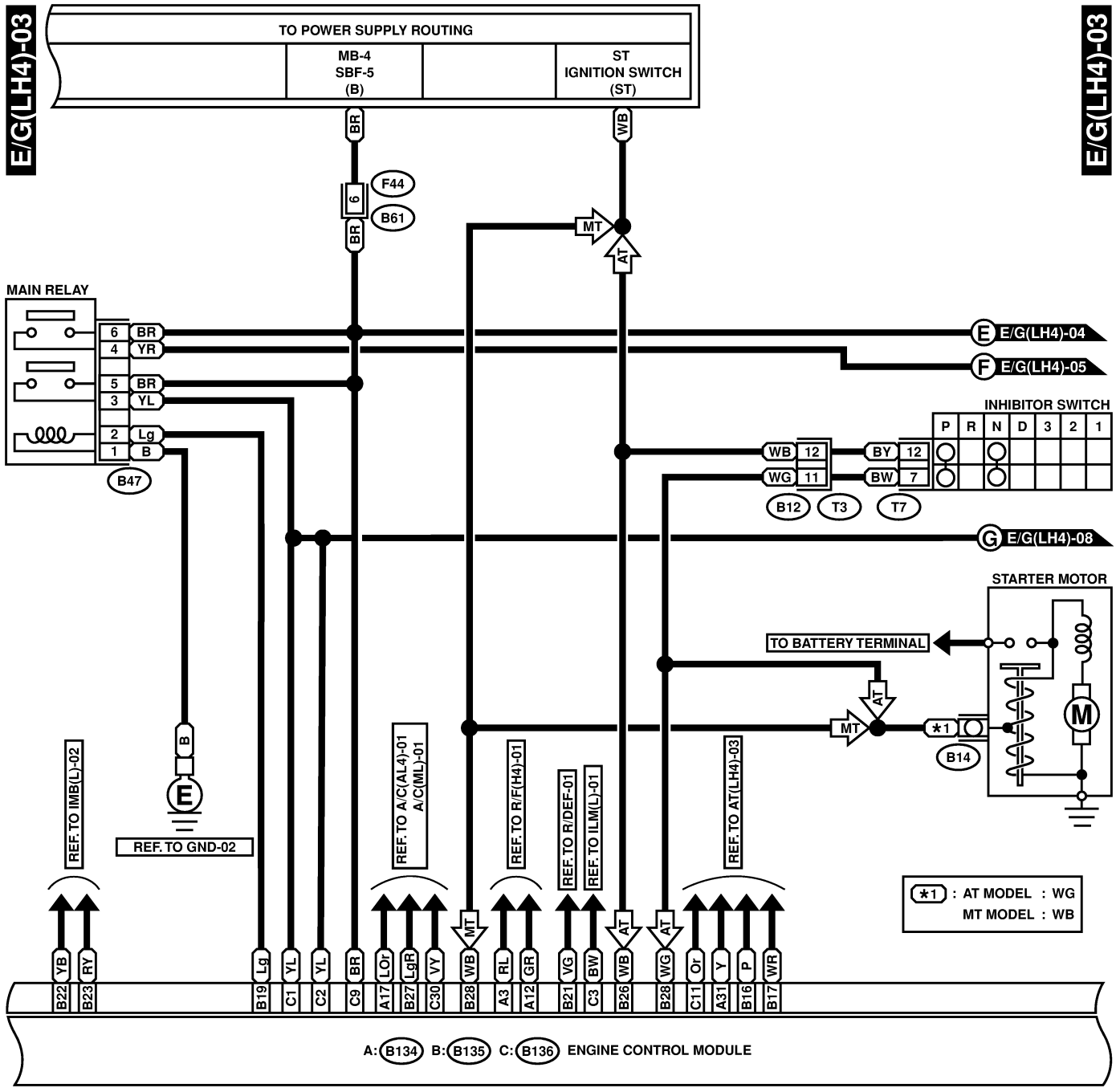

ENGINE ELECTRICAL SYSTEM

Wiring System

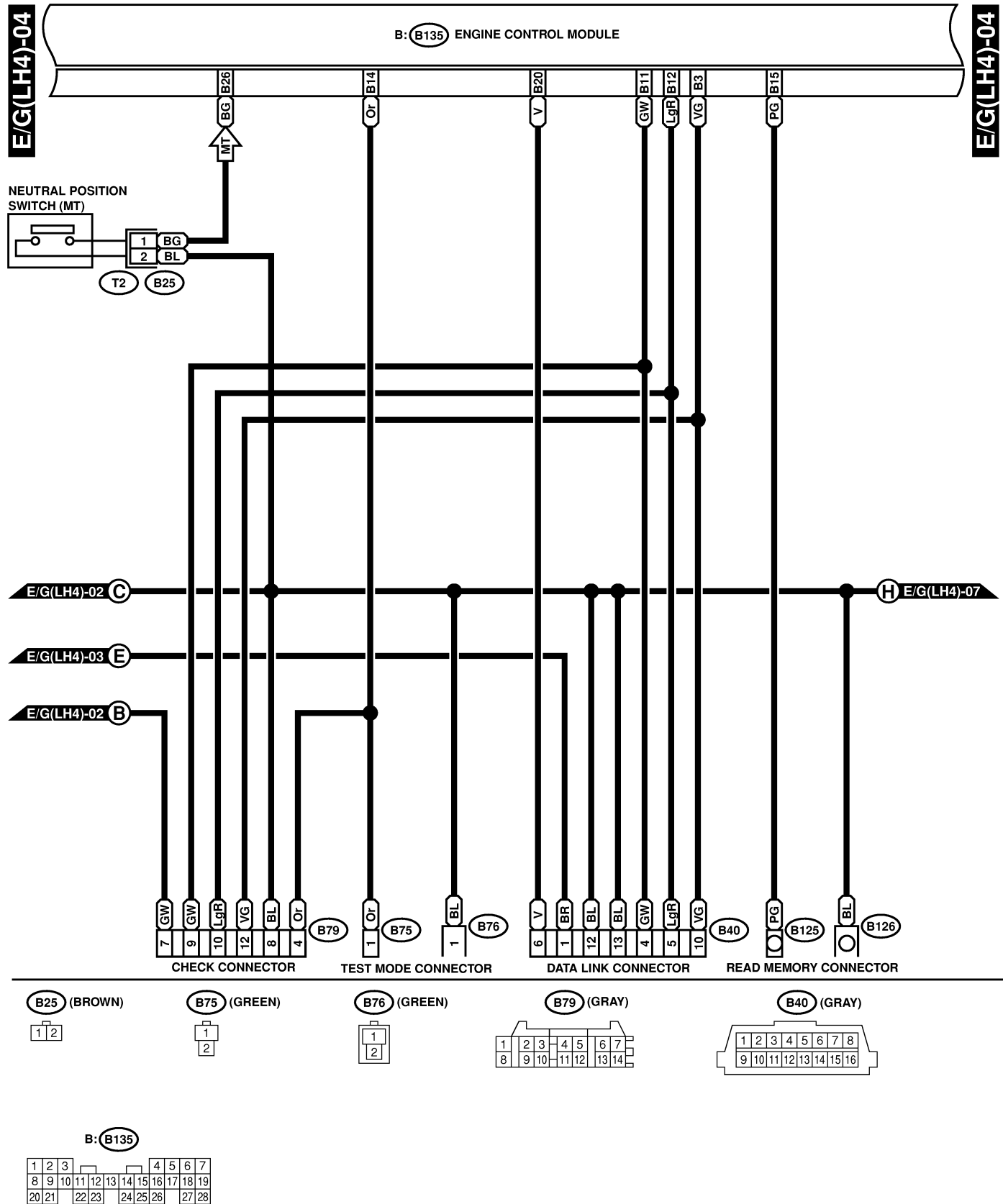

ENGINE ELECTRICAL SYSTEM

Wiring System

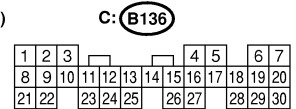
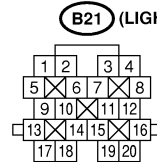
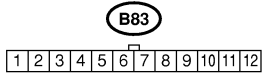
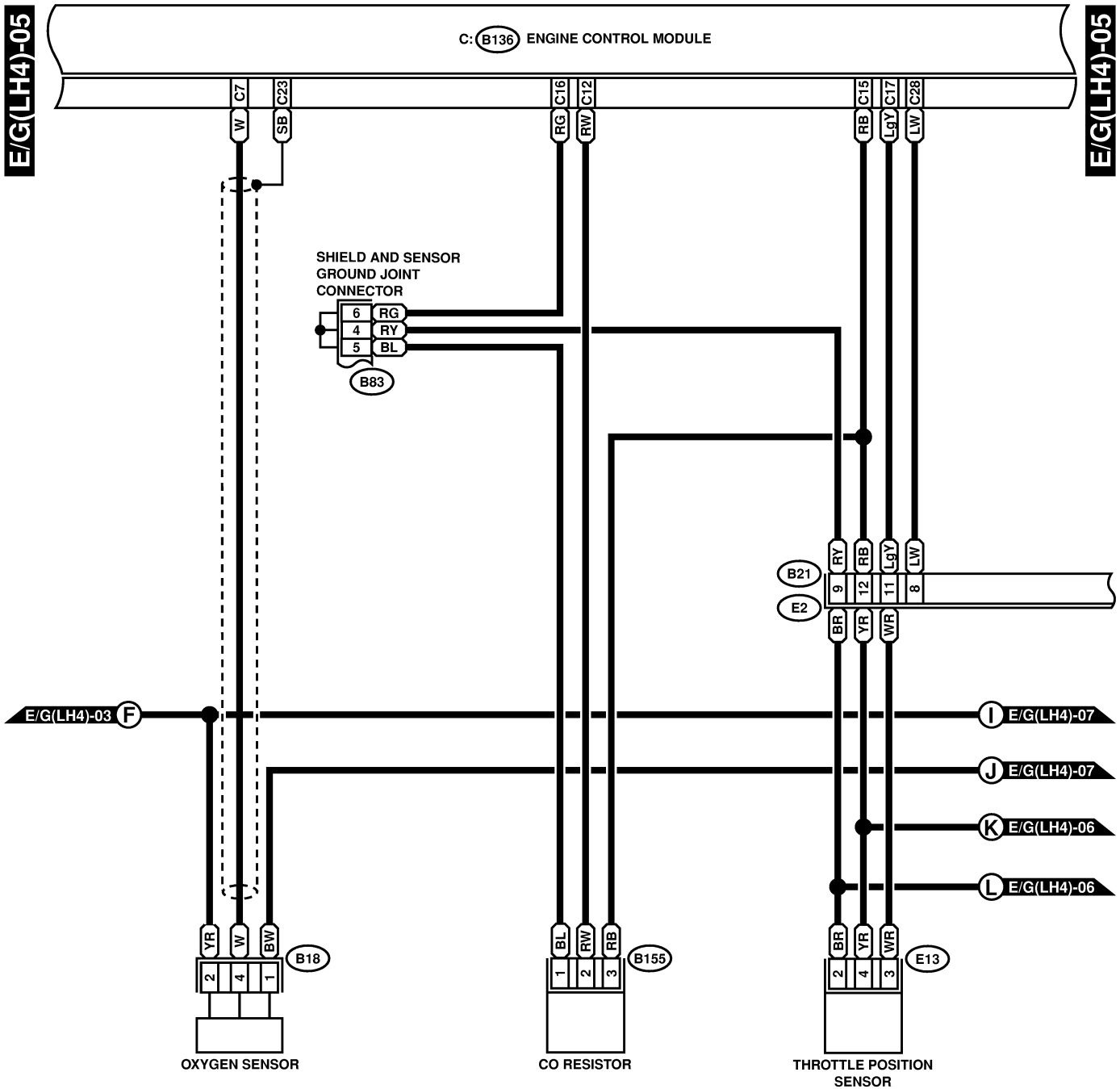

ENGINE ELECTRICAL SYSTEM

Wiring System

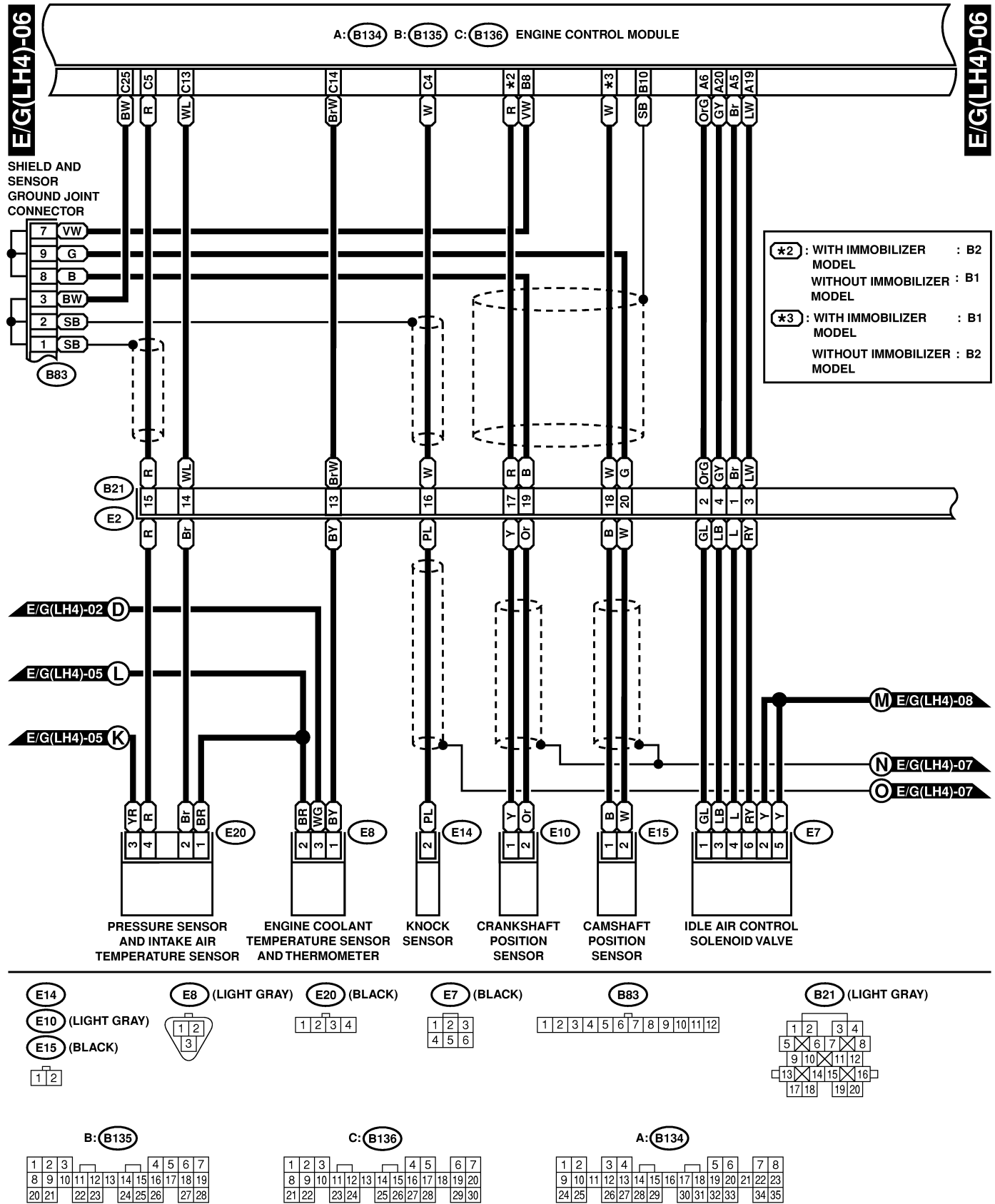

ENGINE ELECTRICAL SYSTEM

Wiring System

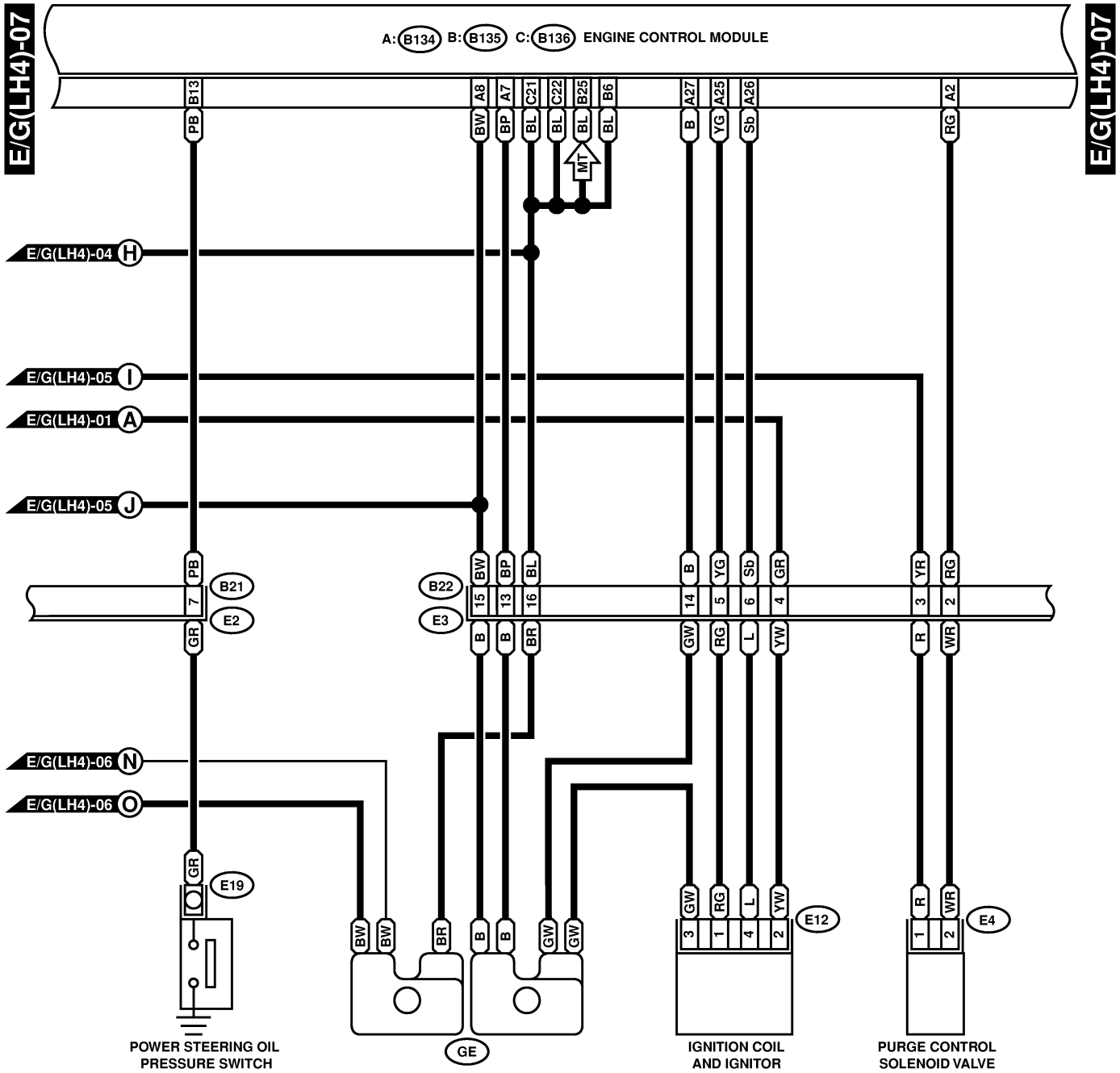

E4 (BLUE)



E12 (DARK GRAY)



B22 (BROWN)



B21 (LIGHT GRAY)

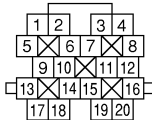

B: B135

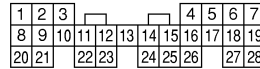

C: B136

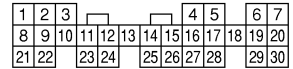

A: B134

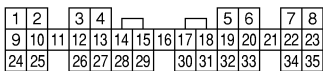

ENGINE ELECTRICAL SYSTEM

Wiring System

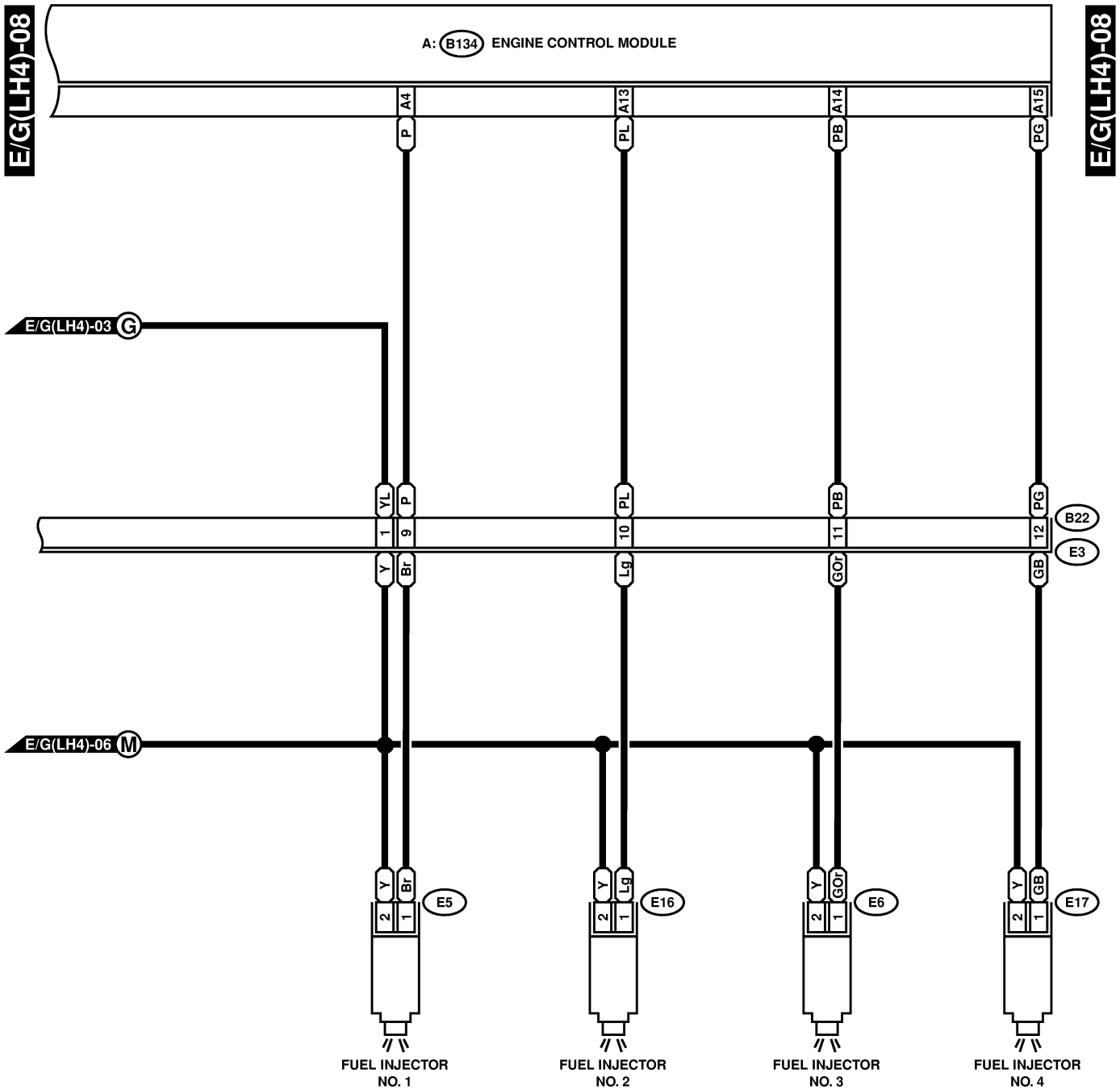

E5 (LIGHT GRAY)

E6 (LIGHT GRAY)

E16 (LIGHT GRAY)

E17 (LIGHT GRAY)



B22 (BROWN)



A: (B134)

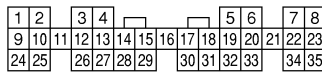

ENGINE ELECTRICAL SYSTEM

Wiring System

2. LHD-H4 WITH OBD MODEL S903482A2109

E/G(L40)-01

E/G(L40)-01

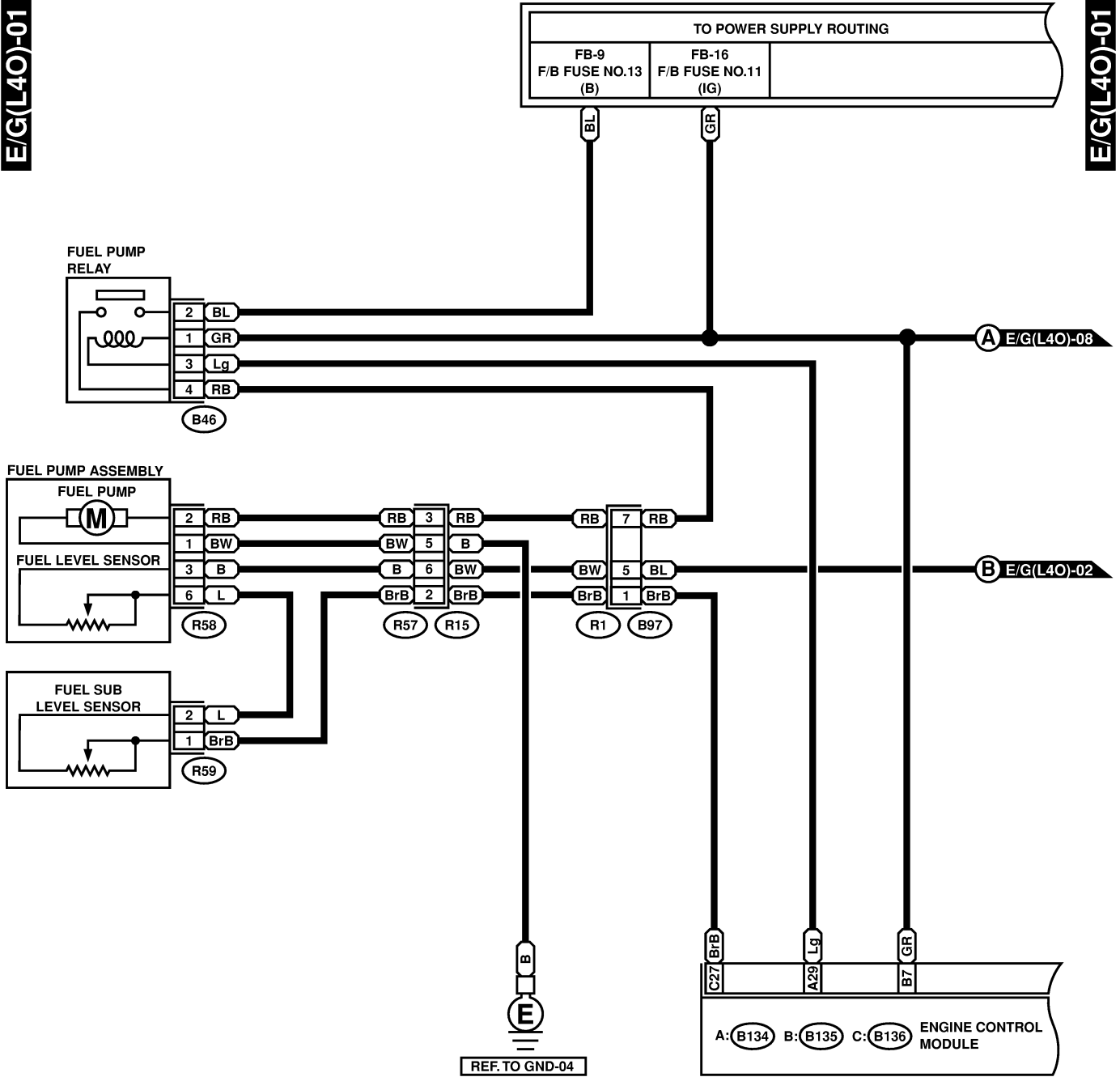

R59

B46 (GREEN)

R57 (BLACK)

R58 (GRAY)

B97

B: B135

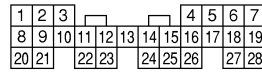

C: B136

A: B134

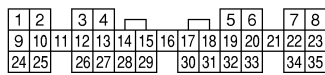
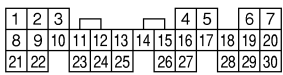

ENGINE ELECTRICAL SYSTEM

Wiring System

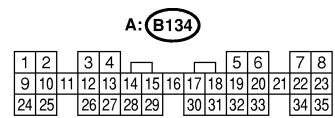
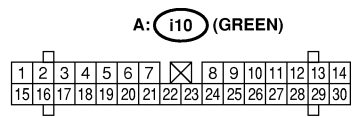
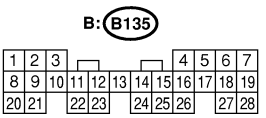
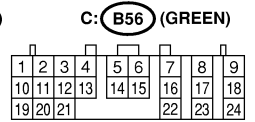
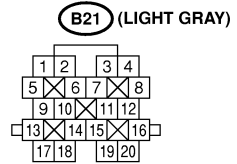
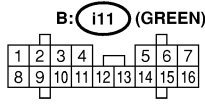
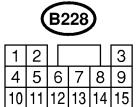
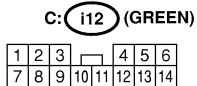
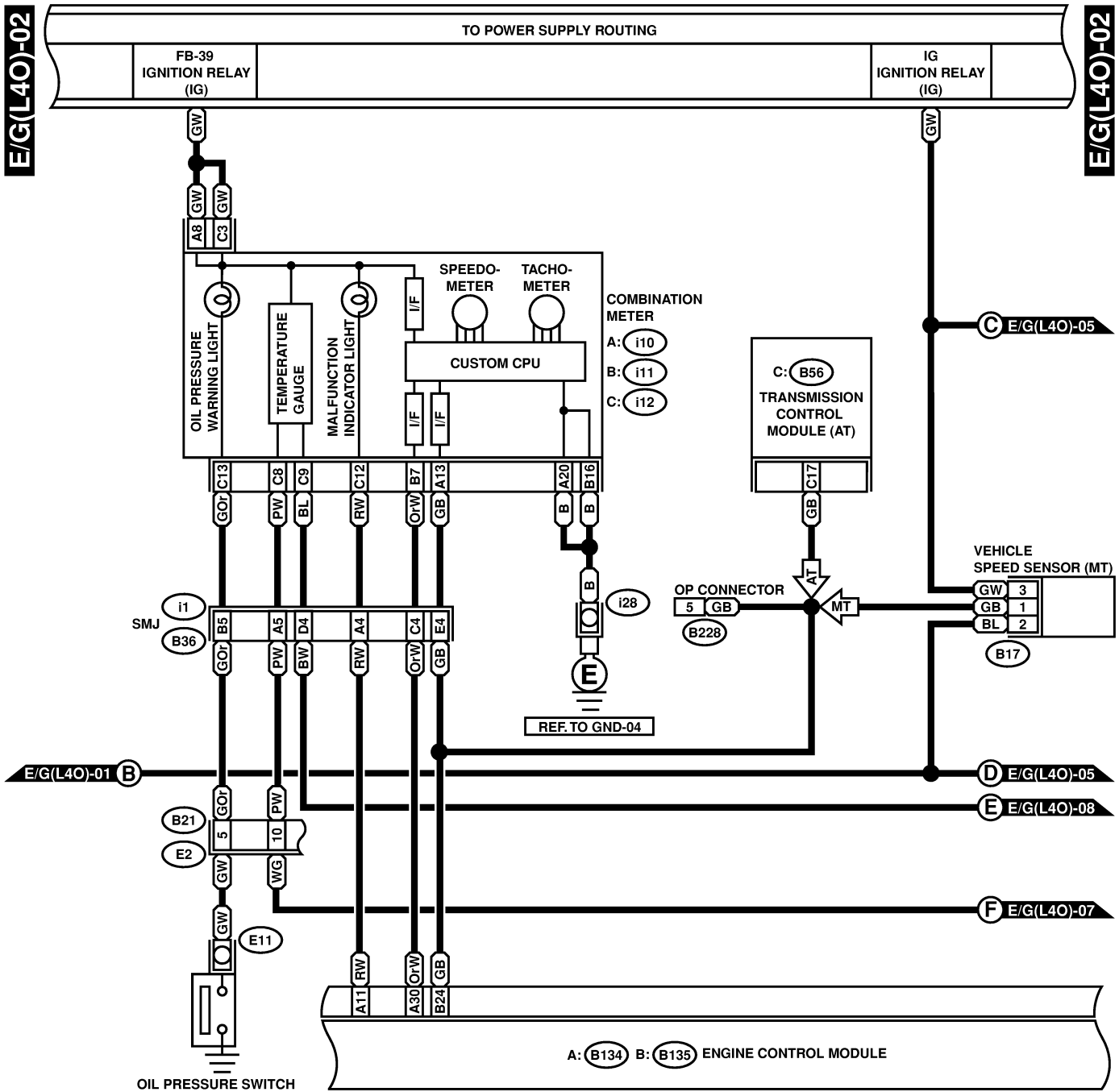

ENGINE ELECTRICAL SYSTEM

Wiring System

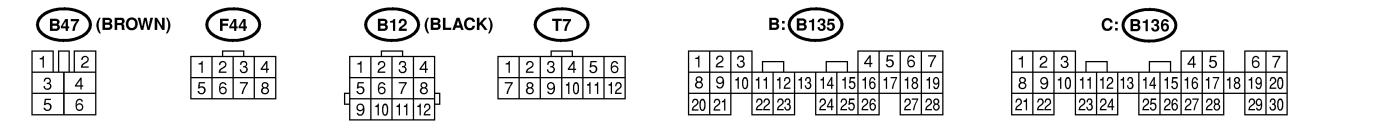
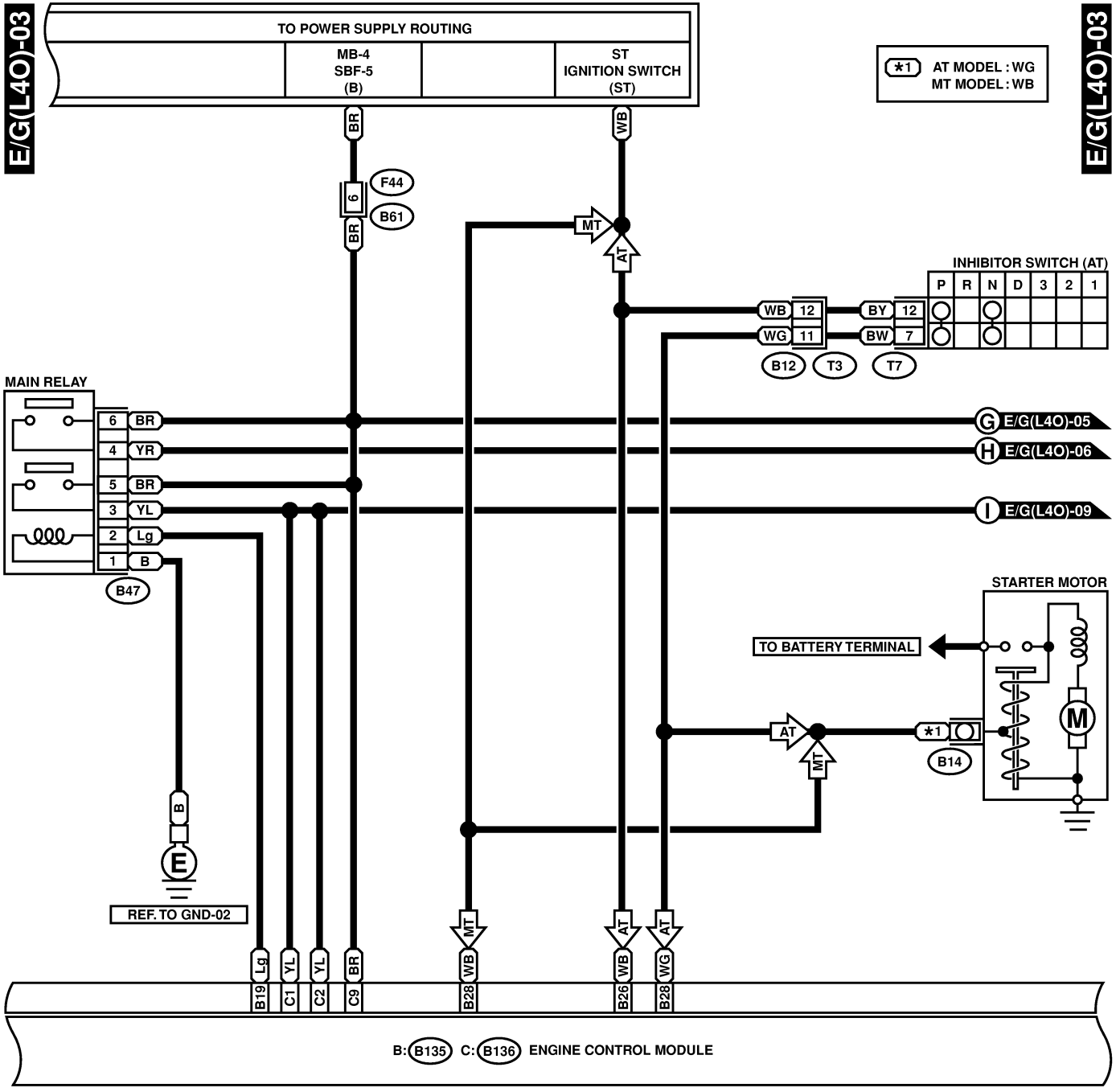

ENGINE ELECTRICAL SYSTEM

Wiring System

E/G(L40)-04

E/G(L40)-04

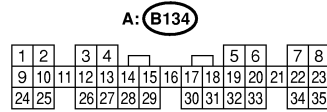
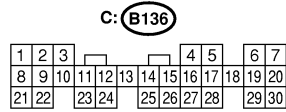
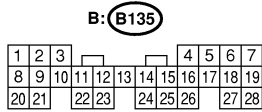
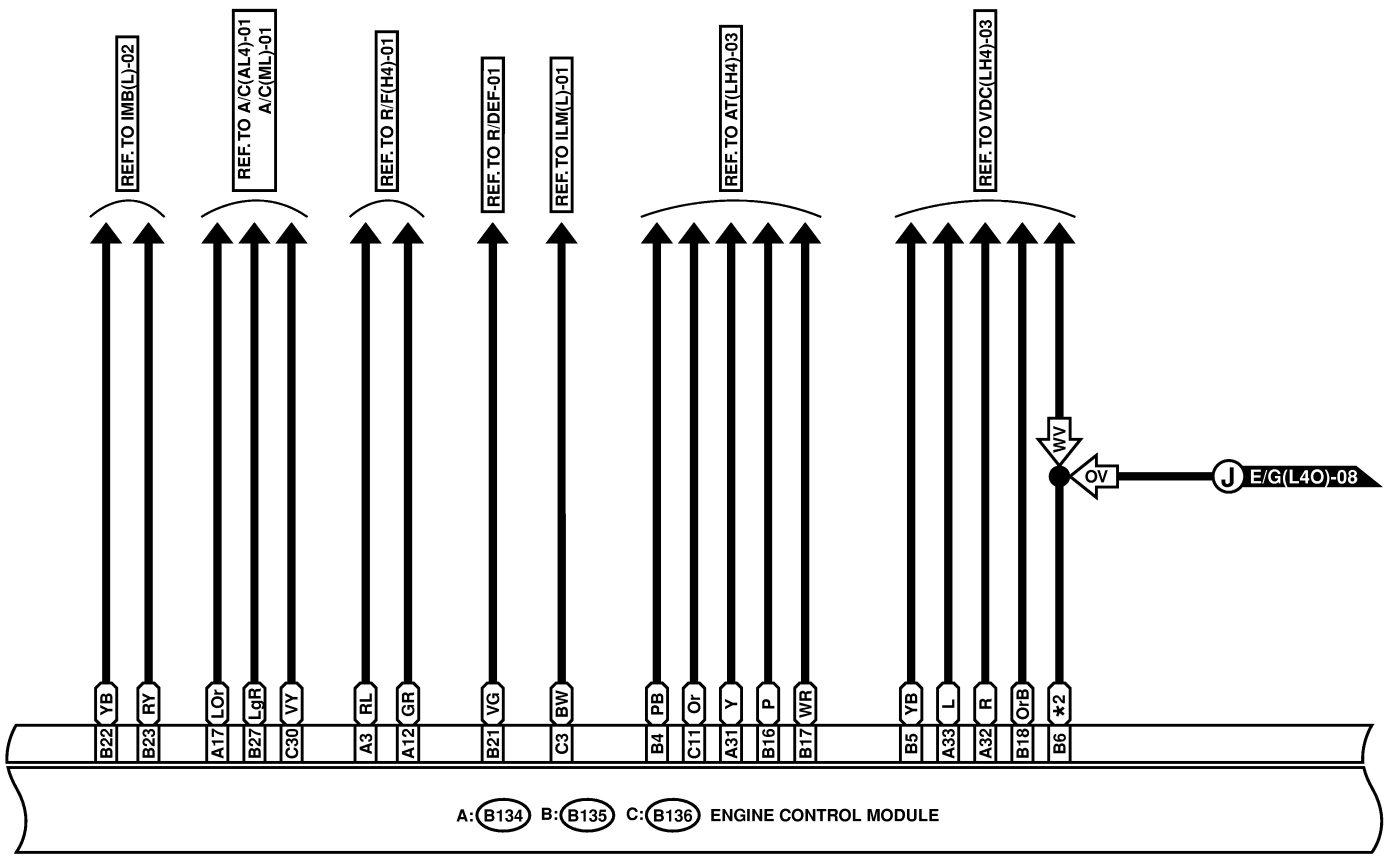
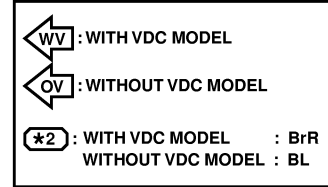

ENGINE ELECTRICAL SYSTEM

Wiring System

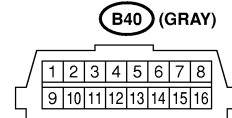
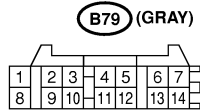
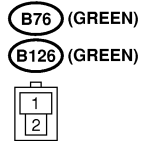
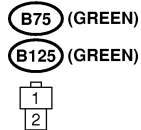
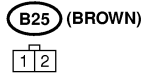
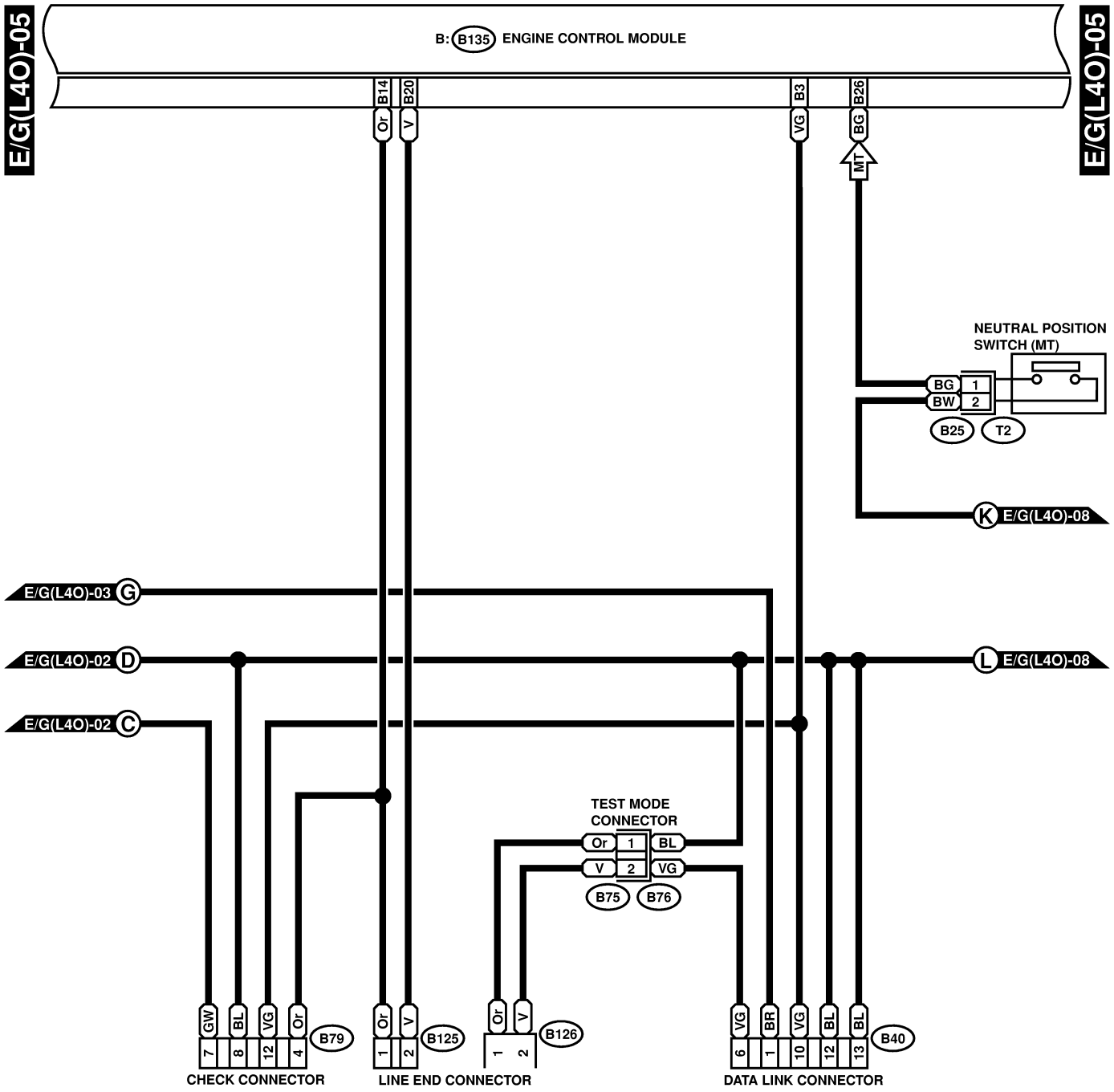

B: (B135)



ENGINE ELECTRICAL SYSTEM

Wiring System

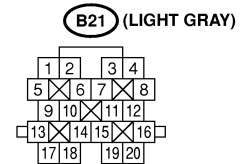
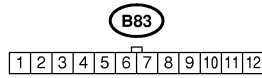
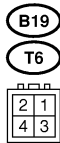
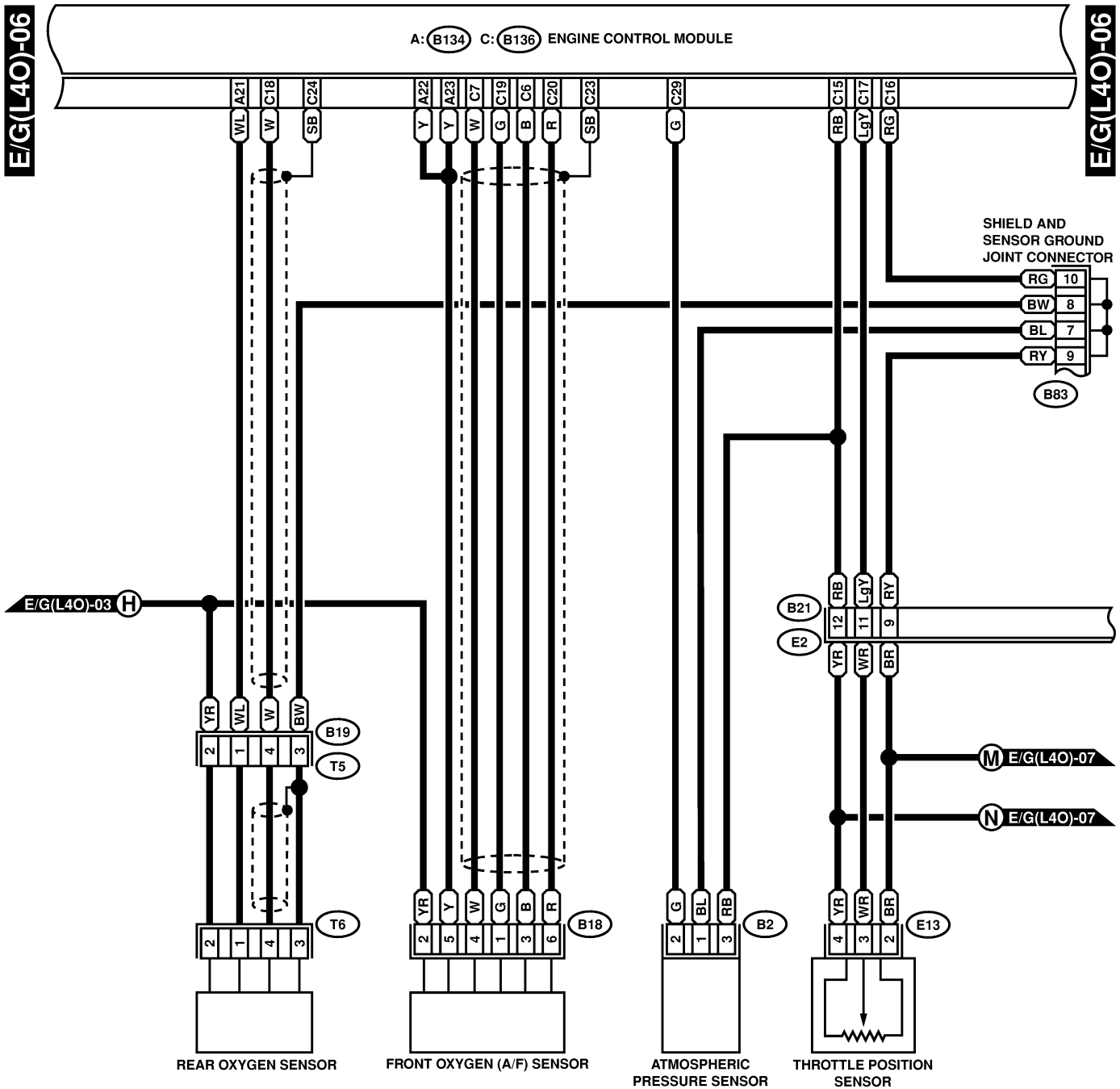

C: B136



A: B134

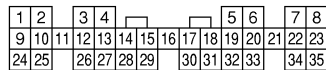

ENGINE ELECTRICAL SYSTEM

Wiring System

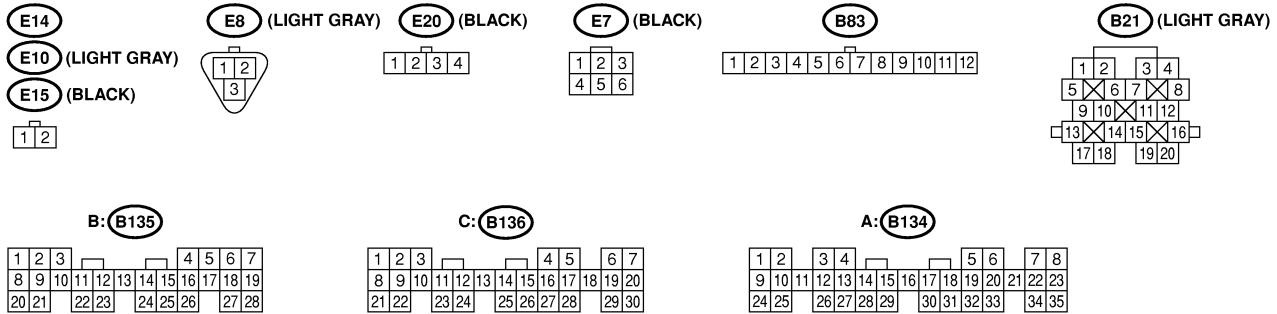
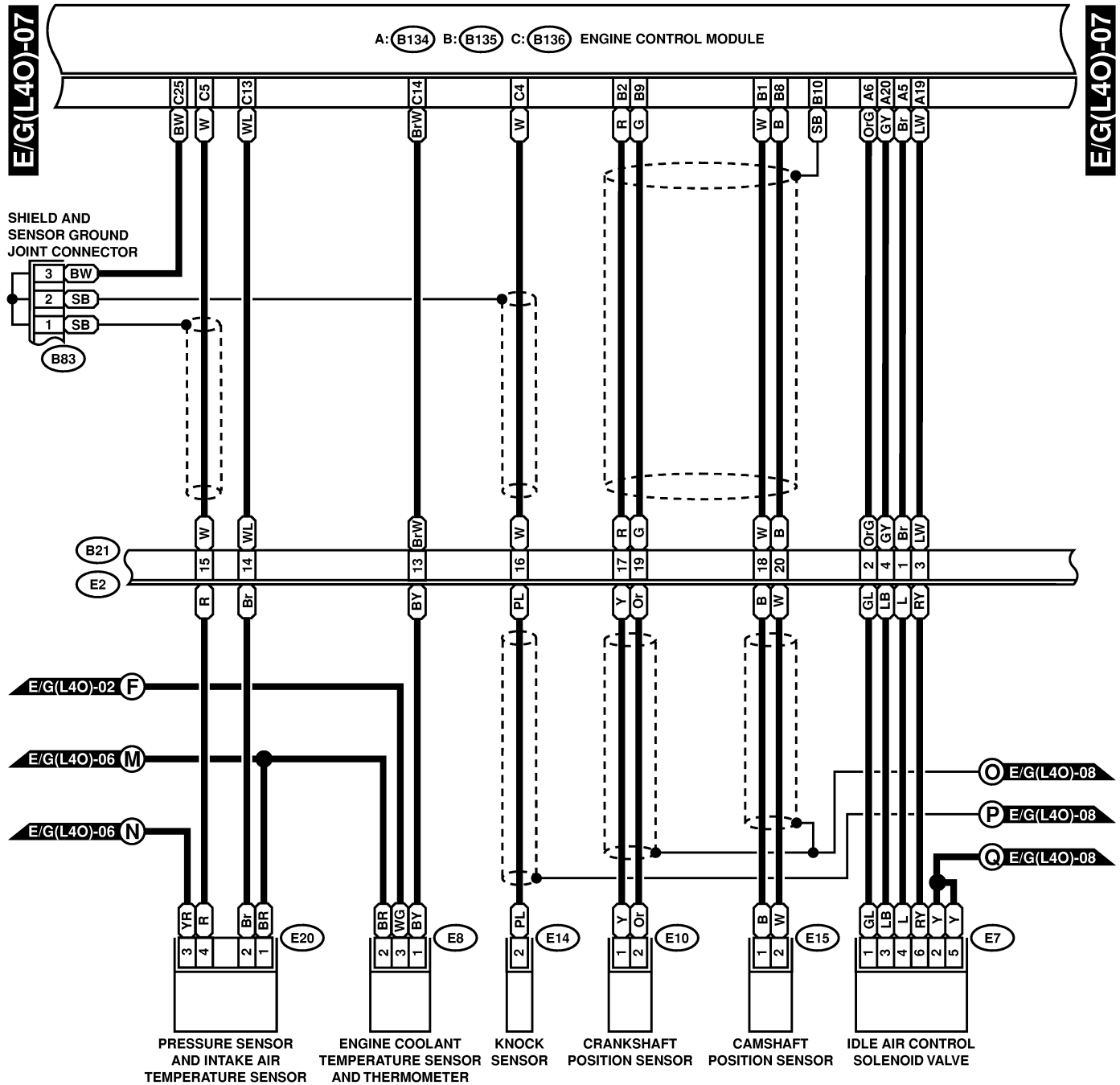

ENGINE ELECTRICAL SYSTEM

Wiring System

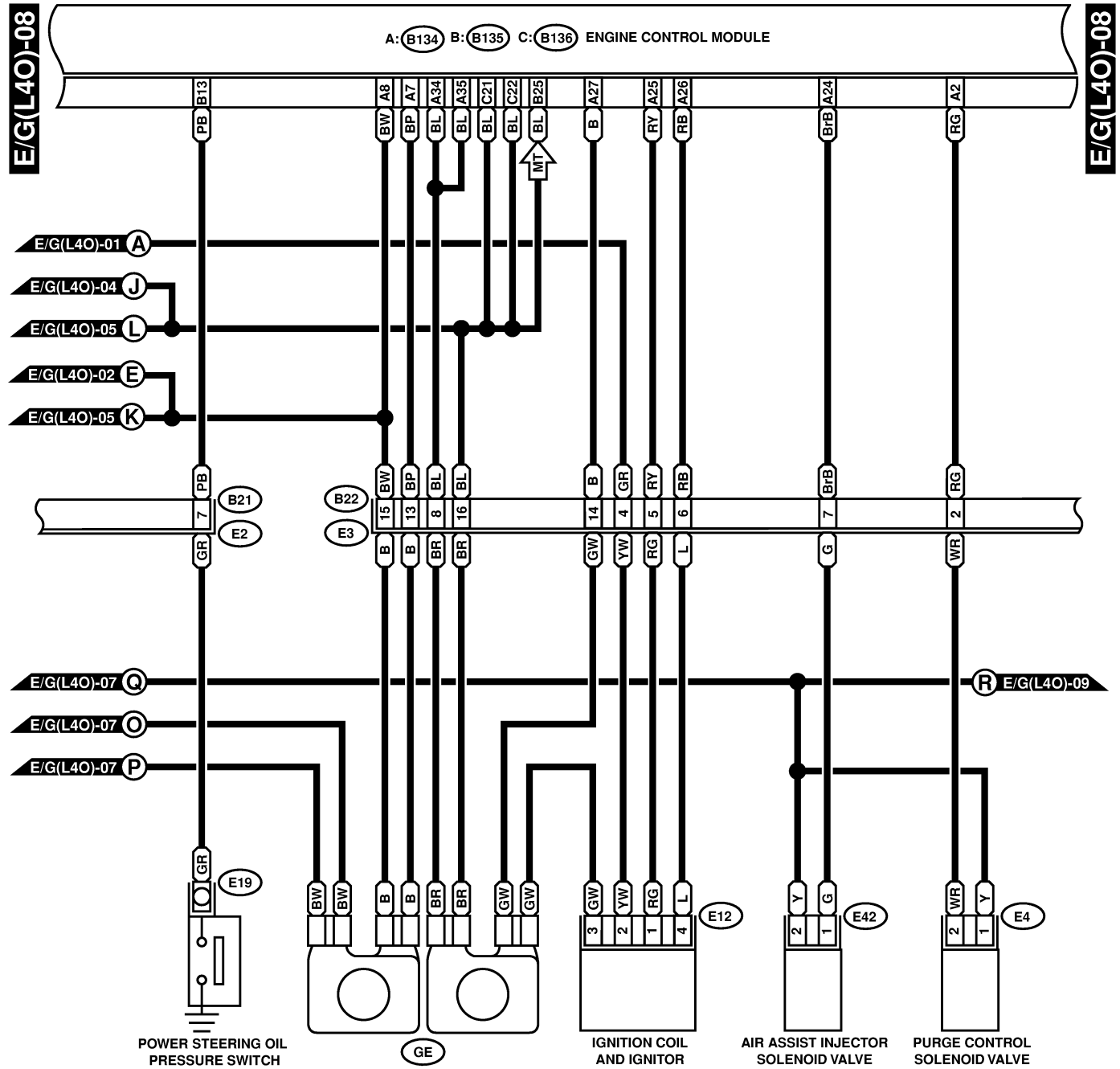

E4 (BLACK)

E42 (PURPLE)



E12 (DARK GRAY)



B22 (BROWN)



B21 (LIGHT GRAY)

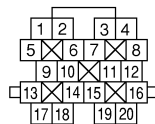

B: B135



C: B136



A: B134

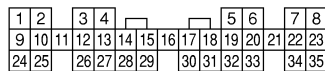

ENGINE ELECTRICAL SYSTEM

Wiring System

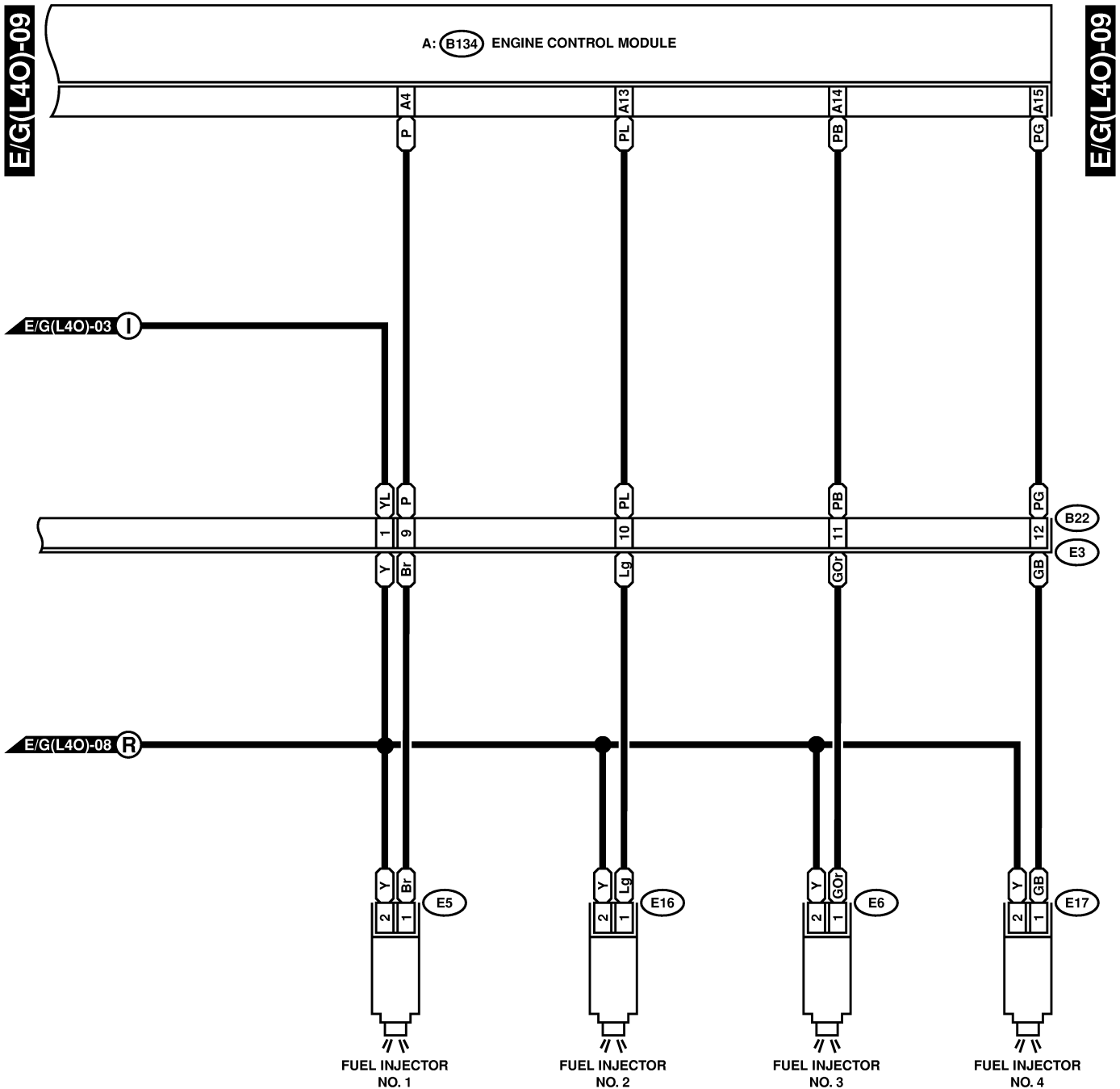

E5 (LIGHT GRAY)

E6 (LIGHT GRAY)

E16 (LIGHT GRAY)

E17 (LIGHT GRAY)



B22 (BROWN)



A: (B134)

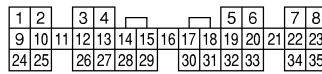

ENGINE ELECTRICAL SYSTEM

Wiring System

3. LHD-H6 MODEL S903482A2110

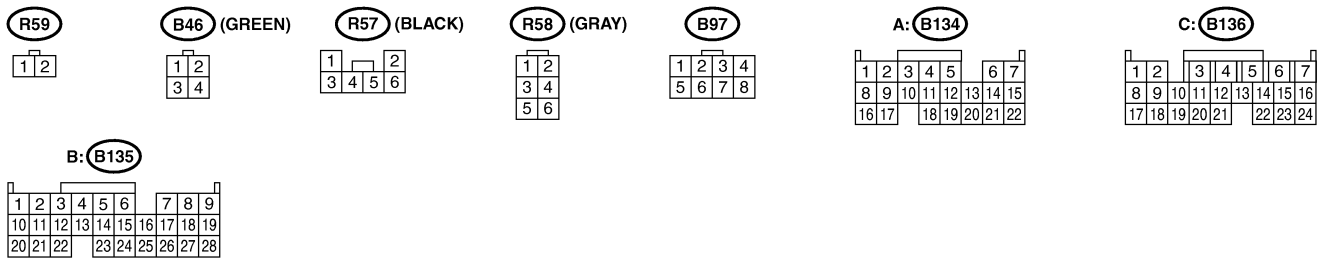
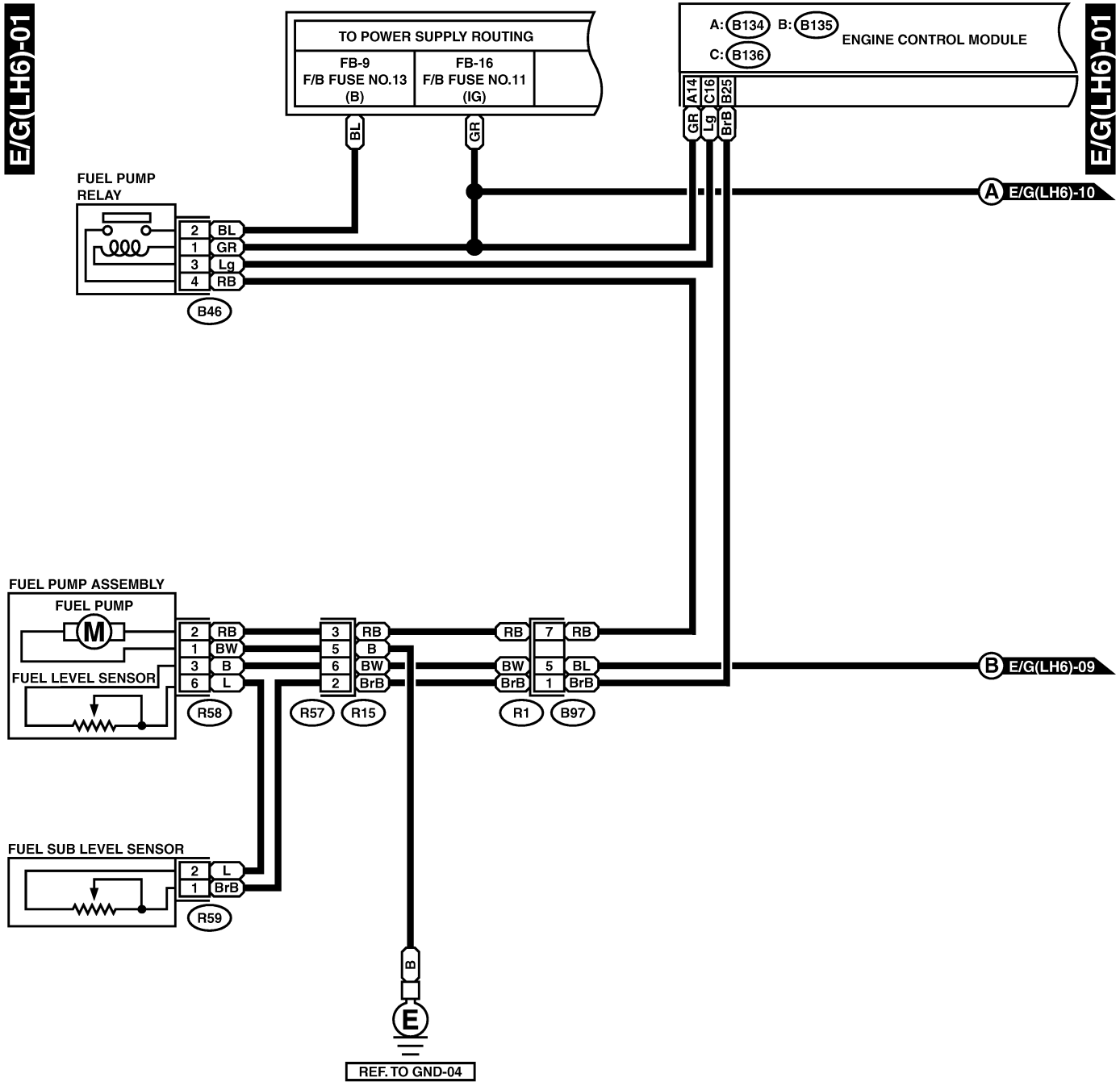

ENGINE ELECTRICAL SYSTEM

Wiring System

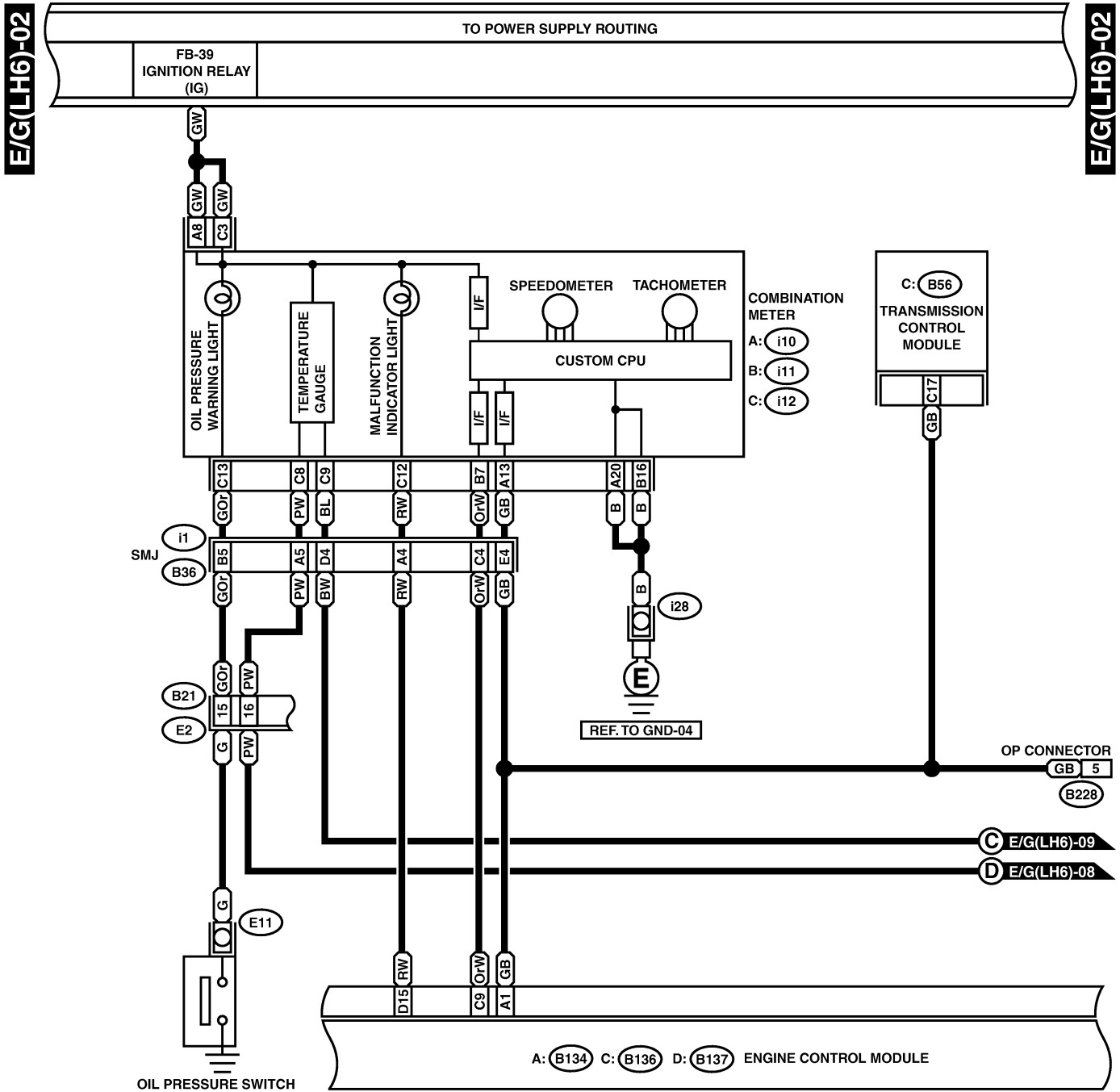

C: i12 (GREEN)

1	2	3	4	5	6
7	8	9	10	11	12
13	14				

B228

1	2	3
4	5	6
7	8	9
10	11	12
13	14	15

B: i11 (GREEN)

1	2	3	4	5	6	7
8	9	10	11	12	13	14
15	16					

B21 (LIGHT GRAY)

1	2	3	4
5	6	7	8
9	10	11	12
13	14	15	16
17	18	19	20

C: B56 (GREEN)

1	2	3	4	5	6	7	8	9
10	11	12	13	14	15	16	17	18
19	20	21				22	23	24

A: B134

1	2	3	4	5	6	7
8	9	10	11	12	13	14
15	16	17	18	19	20	21
22	23	24				

C: B136

1	2	3	4	5	6	7
8	9	10	11	12	13	14
15	16	17	18	19	20	21
22	23	24				

A: i10 (GREEN)

1	2	3	4	5	6	7	8	9	10	11	12	13	14
15	16	17	18	19	20	21	22	23	24	25	26	27	28
29	30												

D: B137

1	2	3	4	5	6	7	8	9
10	11	12	13	14	15	16	17	18
19	20	21				27	28	29
30	31							

ENGINE ELECTRICAL SYSTEM

Wiring System

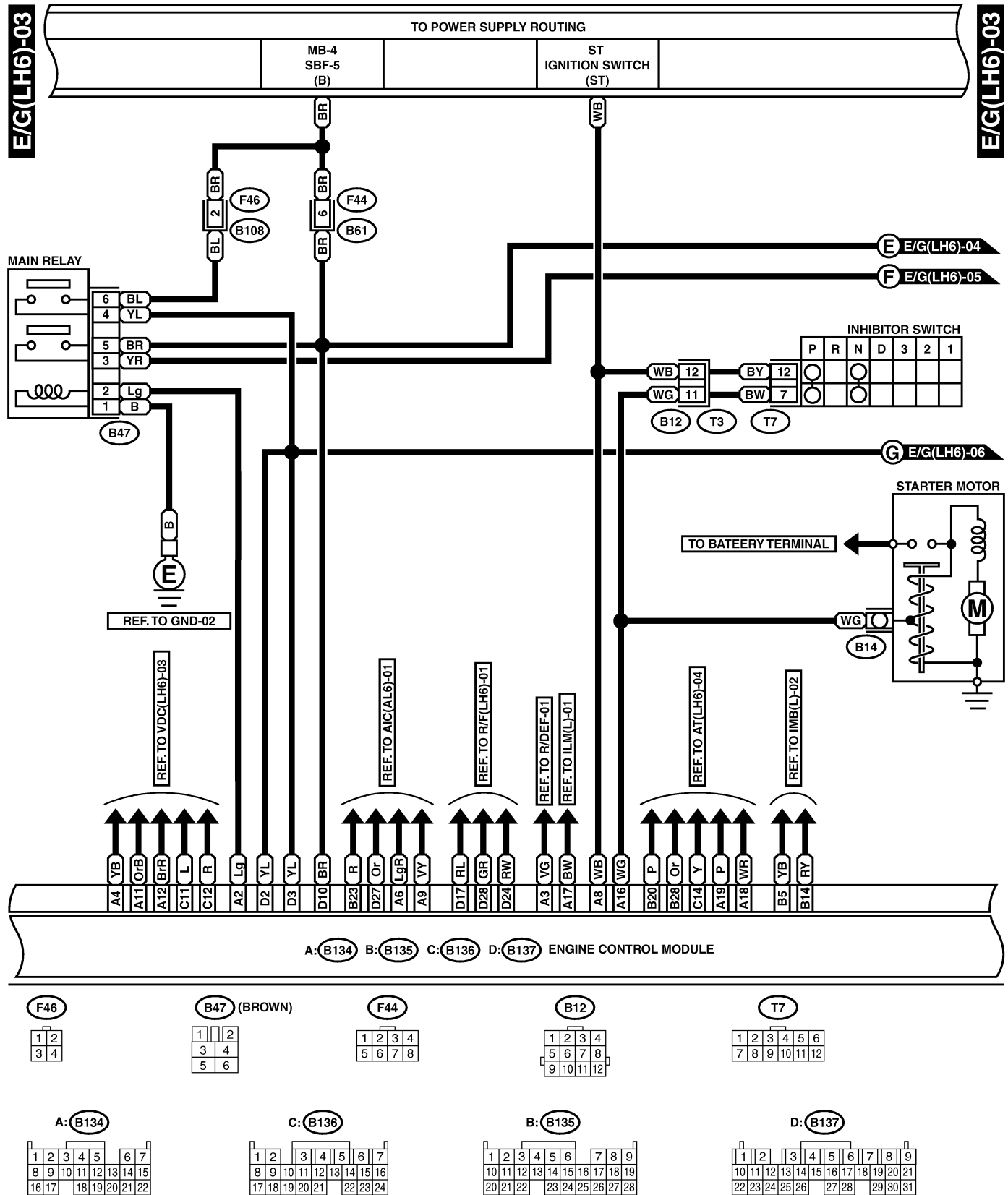

ENGINE ELECTRICAL SYSTEM

Wiring System

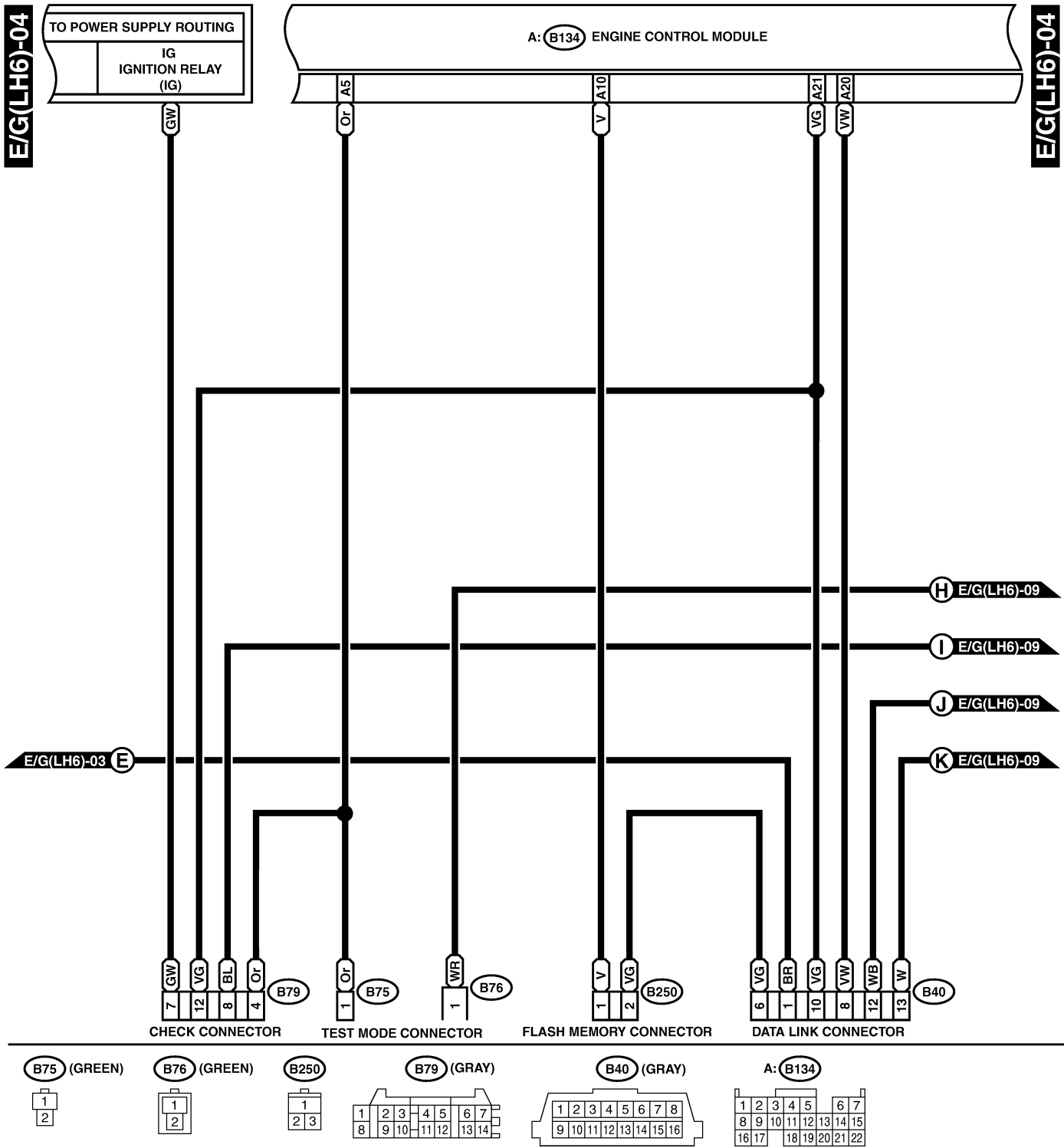

ENGINE ELECTRICAL SYSTEM

Wiring System

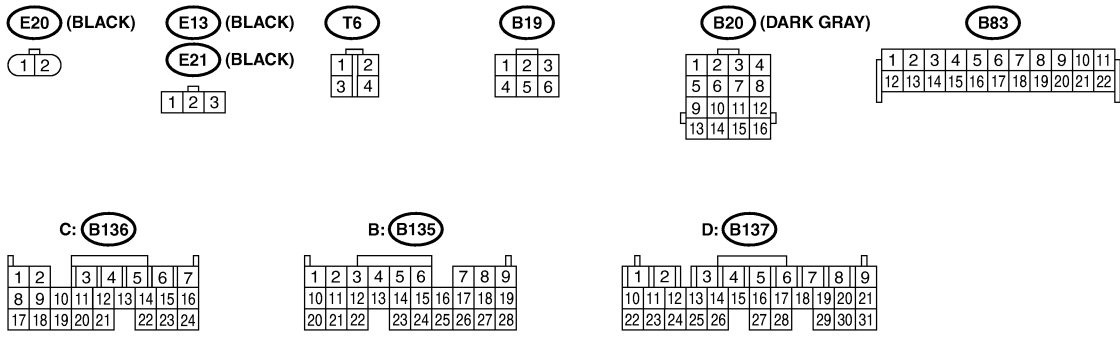
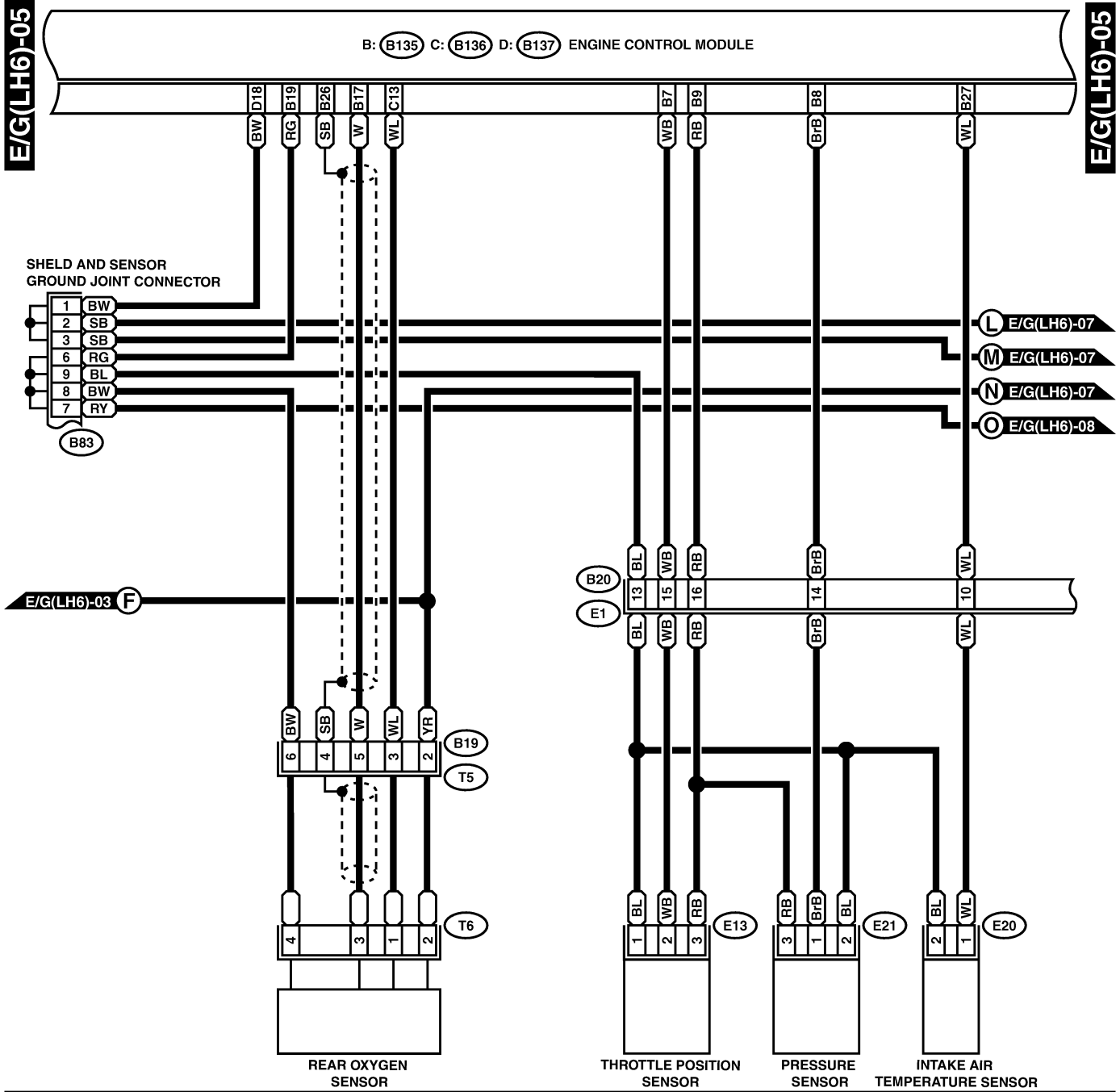

ENGINE ELECTRICAL SYSTEM

Wiring System

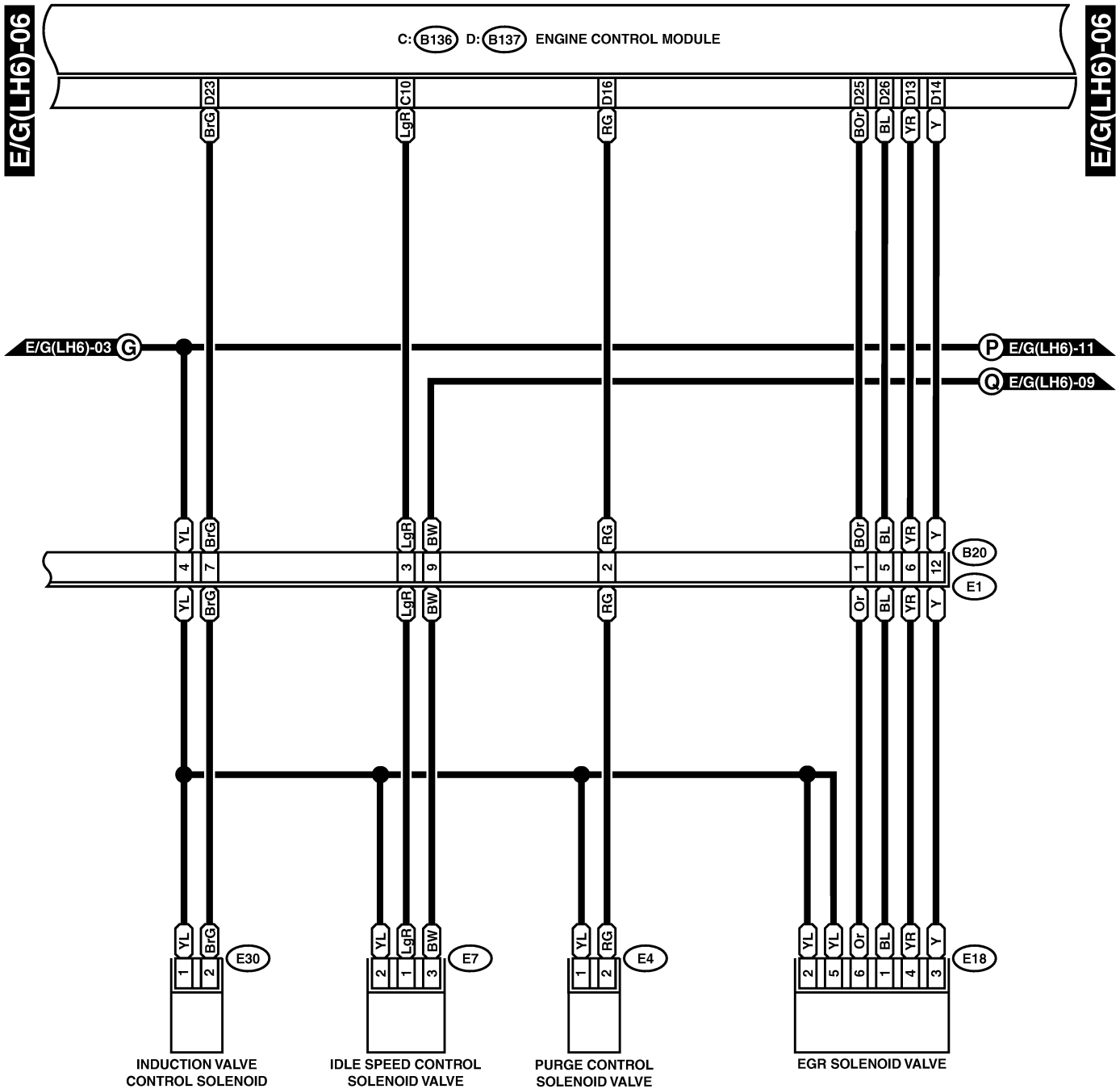

E30 (BROWN)



E4 (BLACK)



E7 (GRAY)



E18 (GRAY)



B20 (DARK GRAY)

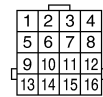

C: B136

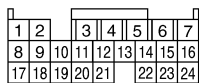

D: B137

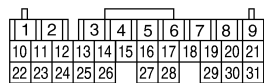

ENGINE ELECTRICAL SYSTEM

Wiring System

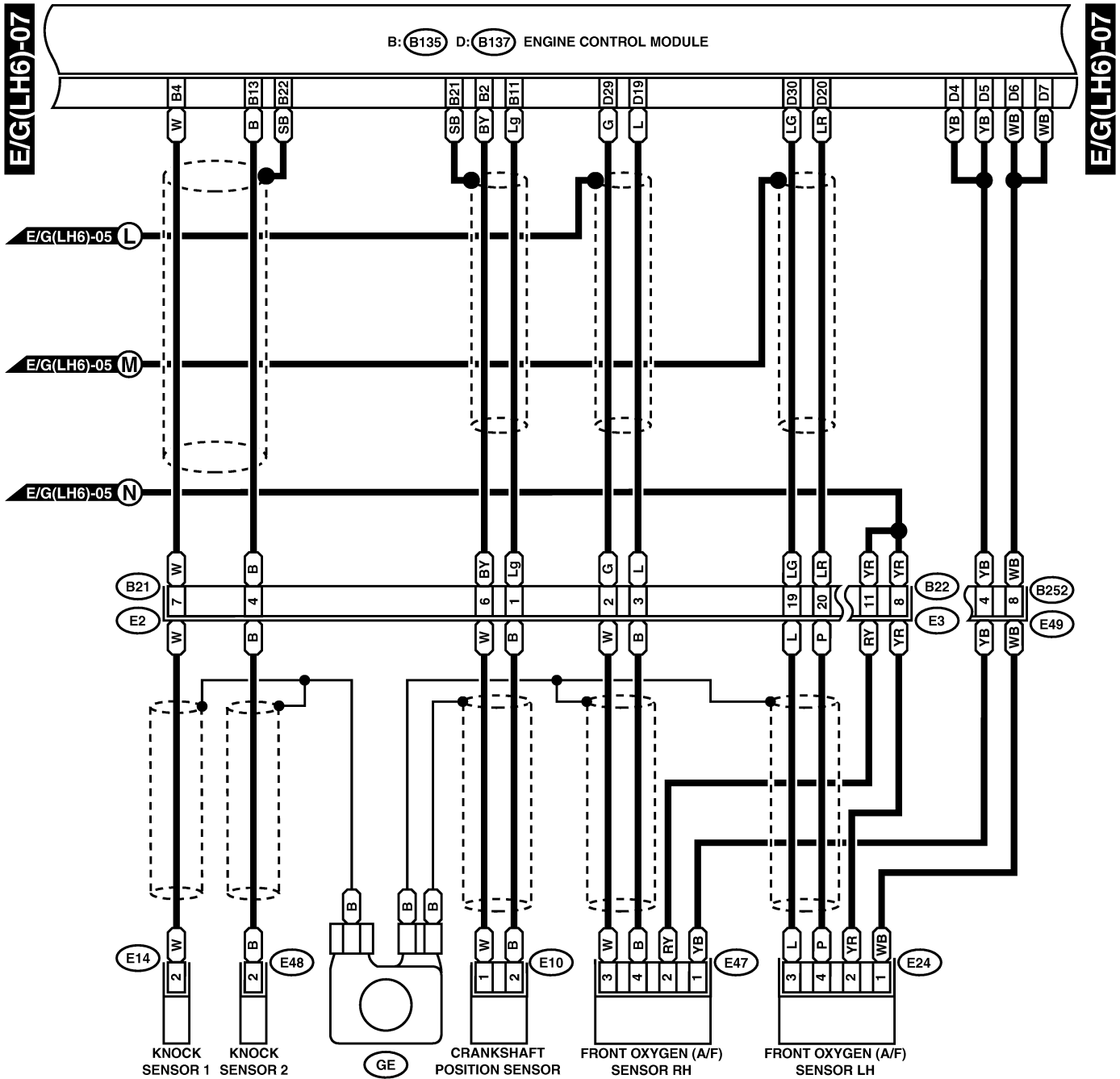

- E14 (BLUE)
- E10 (GRAY)
- E24 (DARK GRAY)
- B252 (DARK GRAY)
- B22 (BROWN)
- B21 (LIGHT GRAY)
- E48 (BLUE)
- 1 2
- E47 (DARK GRAY)
- 1 2 3 4
5 6 7 8
- 1 2 3 4
5 6 7 8
9 10 11 12
13 14 15 16
- 1 2 3 4
5 6 7 8
9 10 11 12
13 14 15 16
17 18 19 20

B: B135

1	2	3	4	5	6	7	8	9
10	11	12	13	14	15	16	17	18
19	20	21	22	23	24	25	26	27
28								

D: B137

1	2	3	4	5	6	7	8	9
10	11	12	13	14	15	16	17	18
19	20	21	22	23	24	25	26	27
28	29	30	31					

ENGINE ELECTRICAL SYSTEM

Wiring System

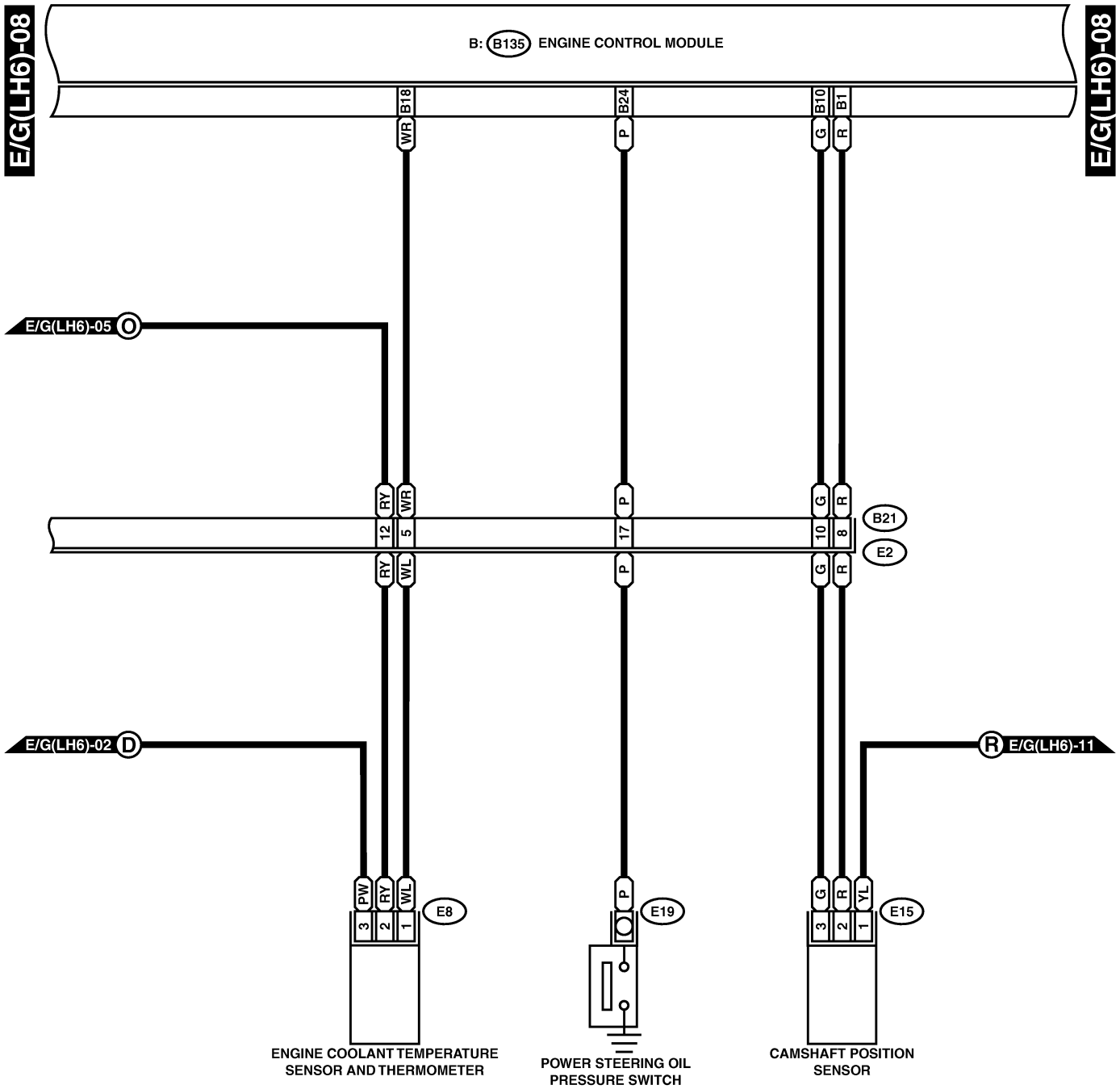

(E15) (GRAY)



(E8) (LIGHT GRAY)



(B21) (LIGHT GRAY)

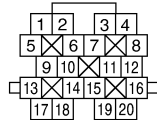

B: (B135)

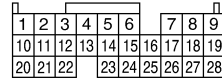

ENGINE ELECTRICAL SYSTEM

Wiring System

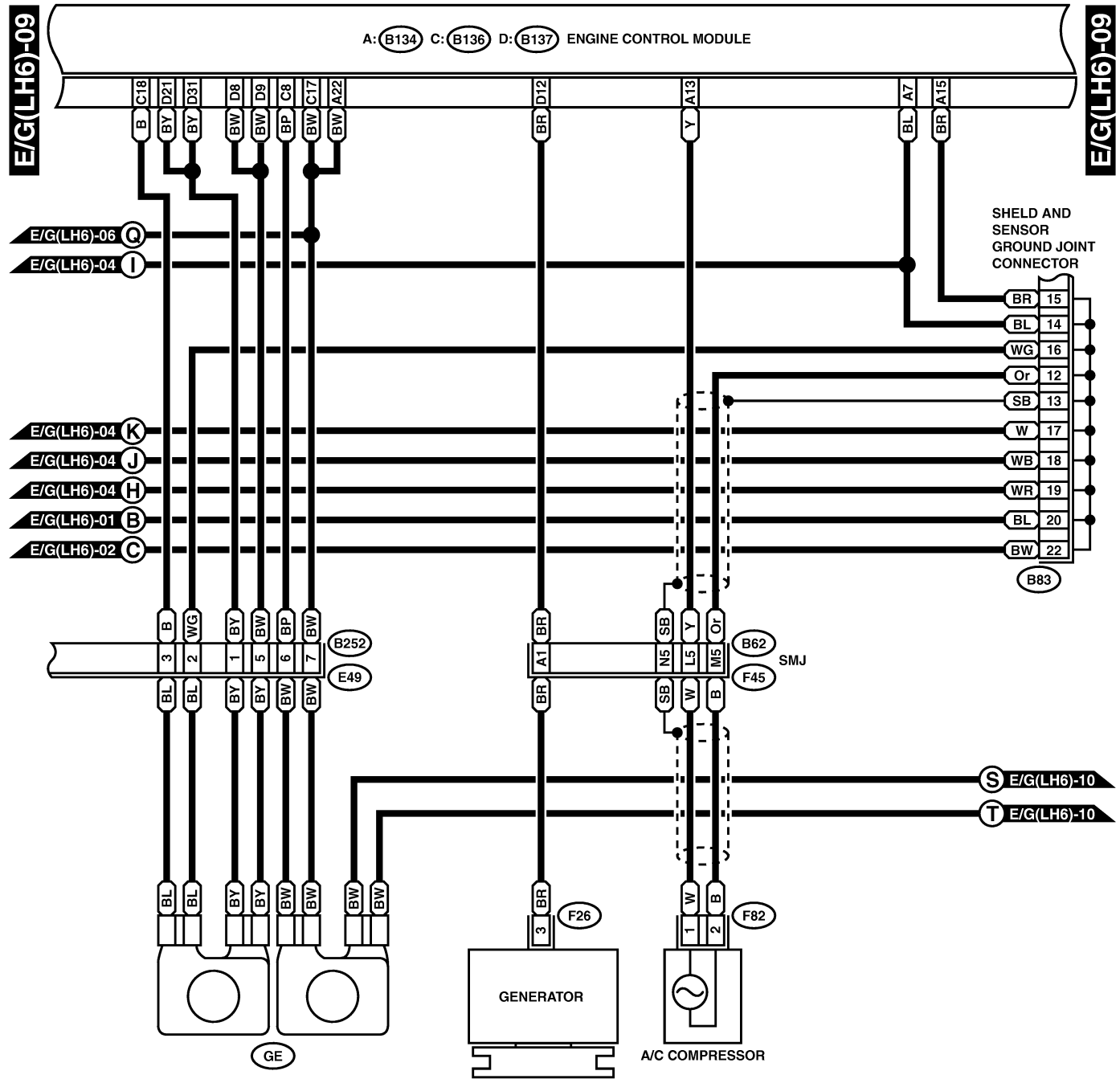

(F26) (GREEN)

(B252) (DARK GRAY)

(B83)

A: (B134)

C: (B136)

D: (B137)

(F82) (BLACK)

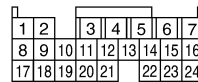
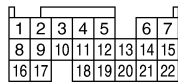
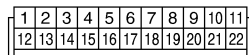
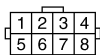

ENGINE ELECTRICAL SYSTEM

Wiring System

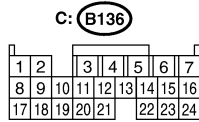
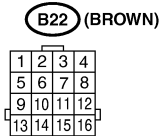
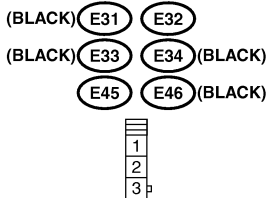
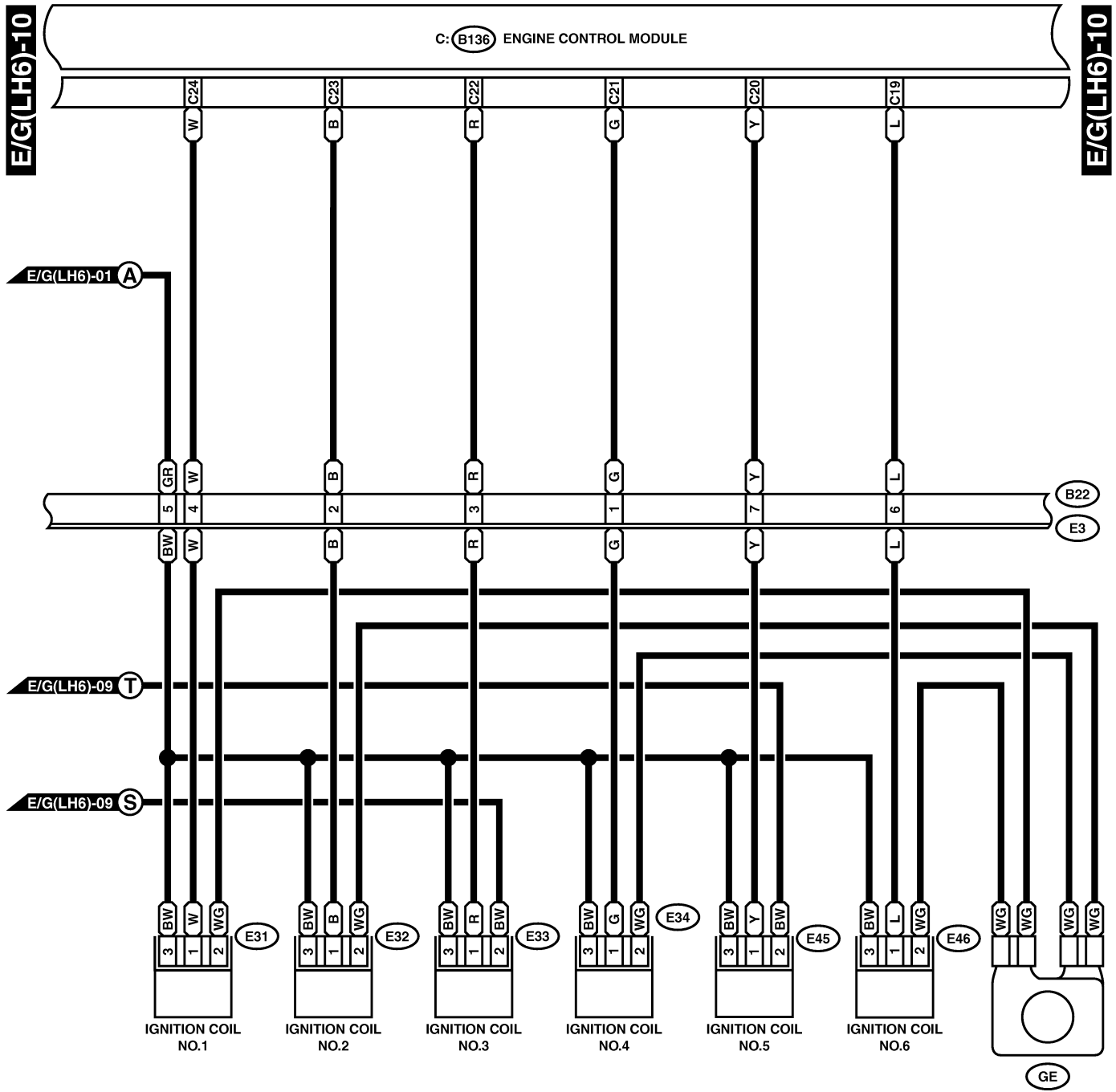

ENGINE ELECTRICAL SYSTEM

Wiring System

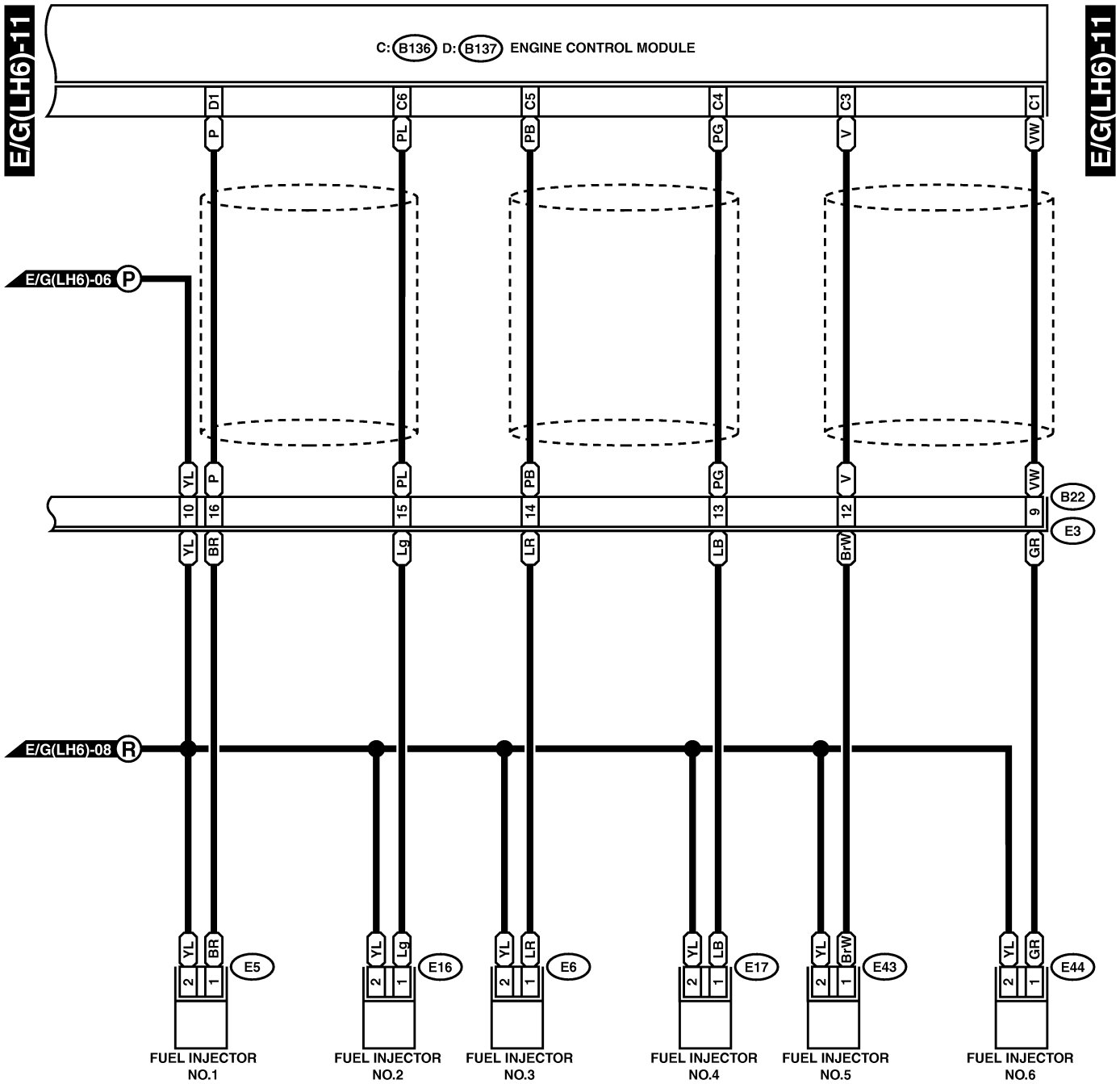

(GRAY) E5 (GRAY) E6 (GRAY)

(GRAY) E16 (GRAY) E17 (GRAY)

(GRAY) E43 (GRAY) E44 (GRAY)

1 2

B22 (BROWN)

1	2	3	4
5	6	7	8
9	10	11	12
13	14	15	16

C: B136

1	2	3	4	5	6	7
8	9	10	11	12	13	14
15	16	17	18	19	20	21
22	23	24				

D: B137

1	2	3	4	5	6	7	8	9
10	11	12	13	14	15	16	17	18
19	20	21	22	23	24	25	26	27
28	29	30	31					

ENGINE ELECTRICAL SYSTEM

Wiring System

4. RHD-H4 WITHOUT OBD MODEL S903482A2111

E/G(RH4)-01

E/G(RH4)-01

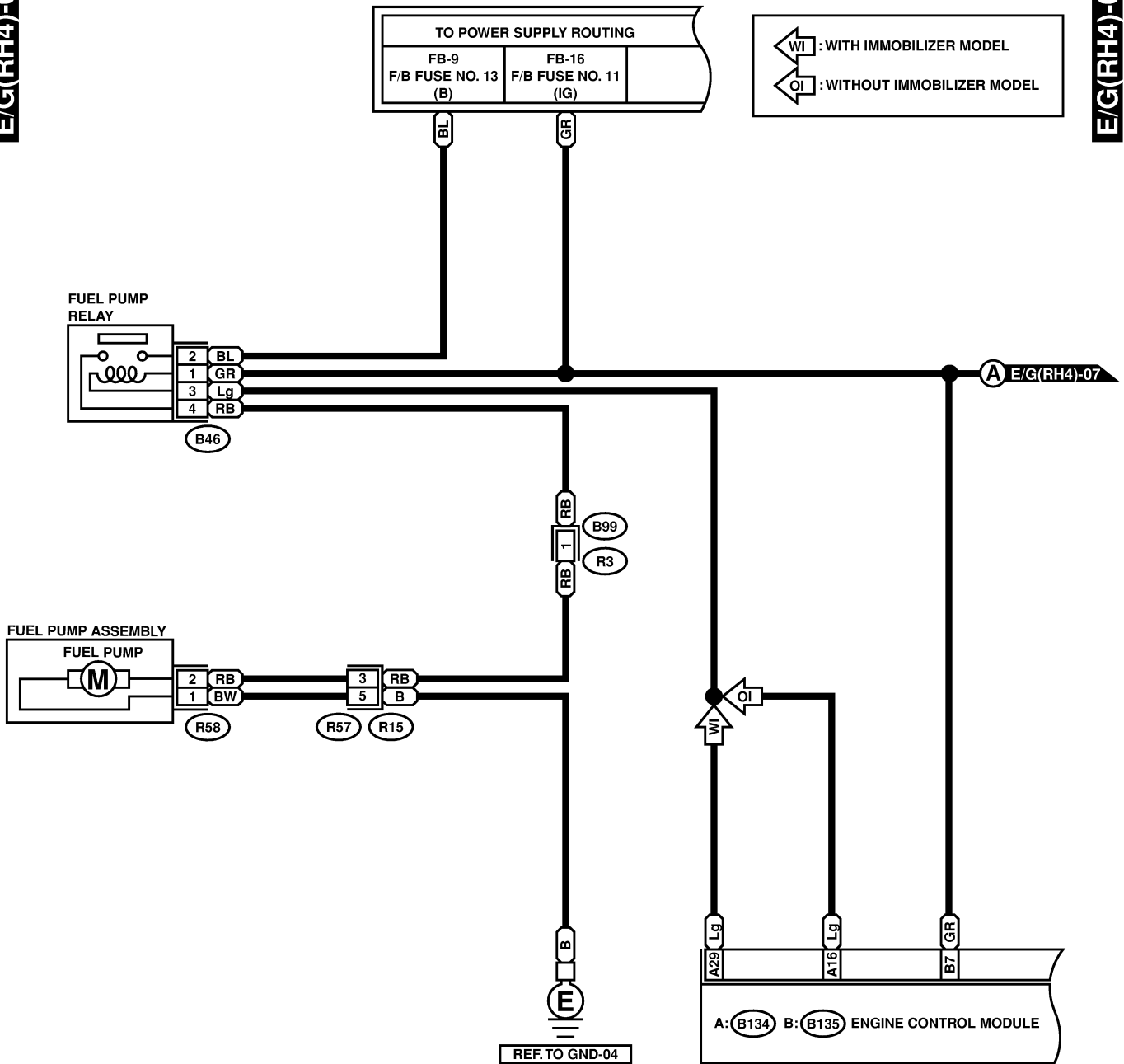

B46 (GREEN)



R57 (BLACK)



R58 (GRAY)



R3

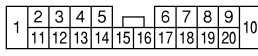

B: B135

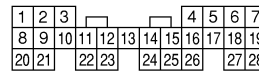

A: B134

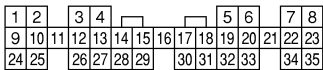

ENGINE ELECTRICAL SYSTEM

Wiring System

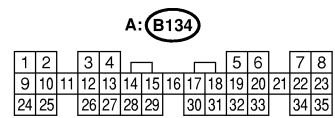
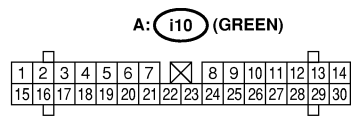
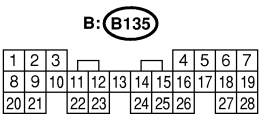
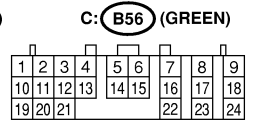
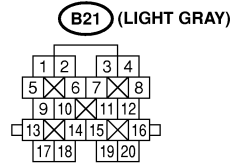
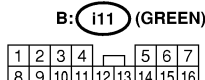
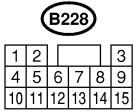
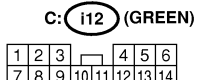
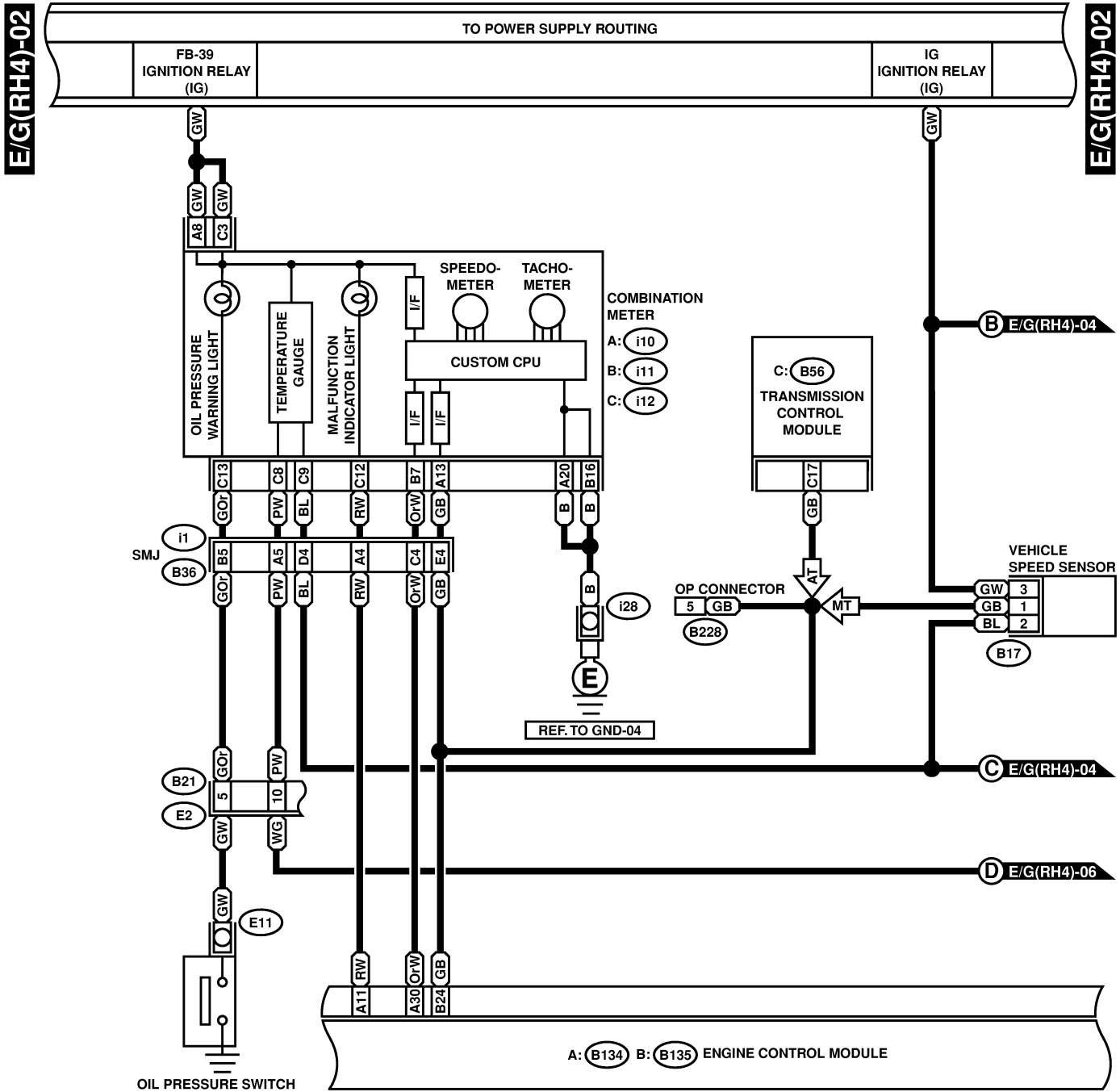

ENGINE ELECTRICAL SYSTEM

Wiring System

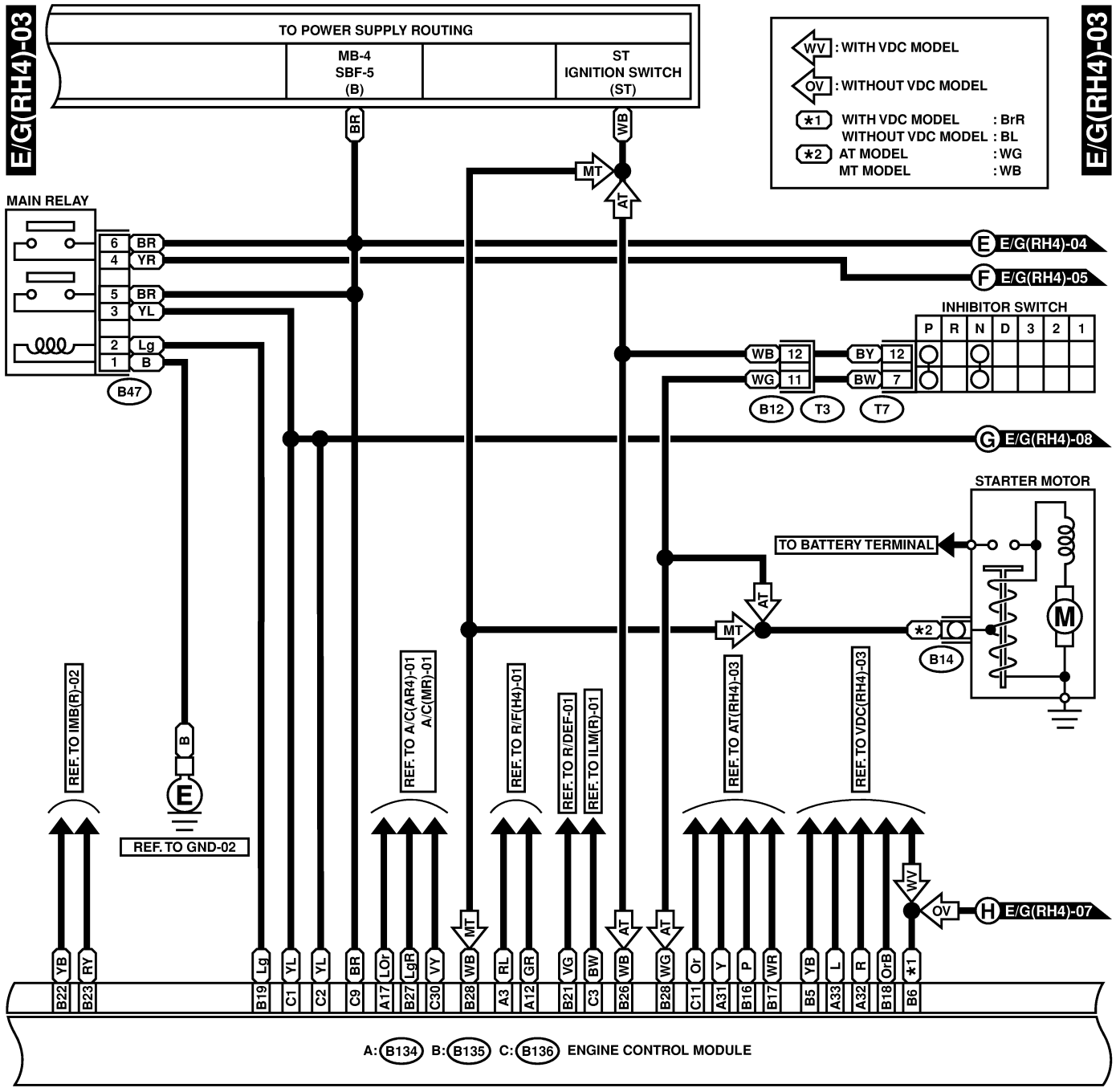

Legend:

- ◀ WV : WITH VDC MODEL
- ◀ OV : WITHOUT VDC MODEL
- *1 WITH VDC MODEL : BrR
- WITHOUT VDC MODEL : BL
- *2 AT MODEL : WG
- MT MODEL : WB

E/G(RH4)-03

E/G(RH4)-03

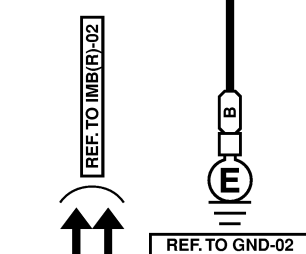
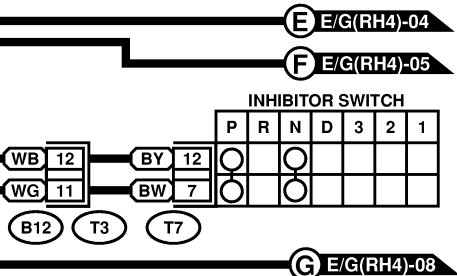
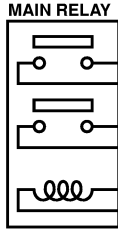

A: (B134) B: (B135) C: (B136) ENGINE CONTROL MODULE

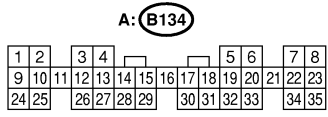
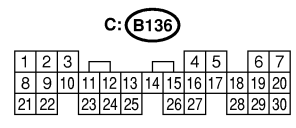
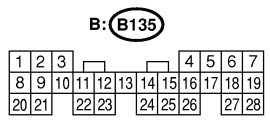
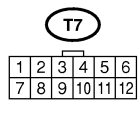
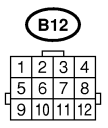
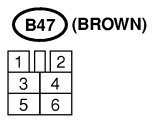

ENGINE ELECTRICAL SYSTEM

Wiring System

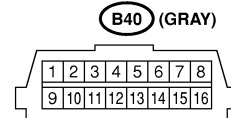
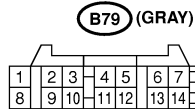
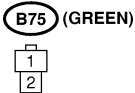
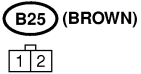
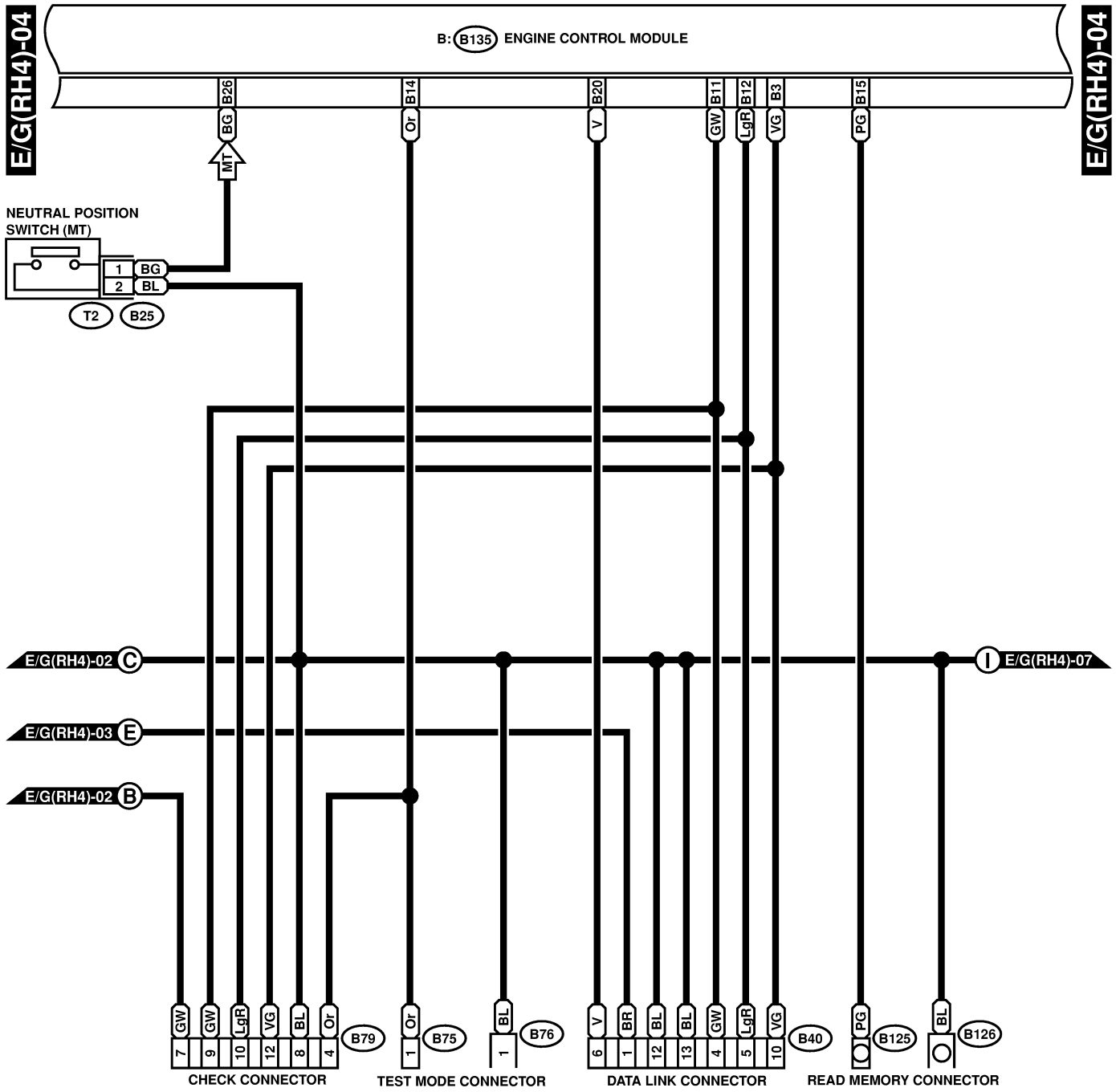

B: (B135)



ENGINE ELECTRICAL SYSTEM

Wiring System

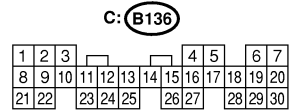
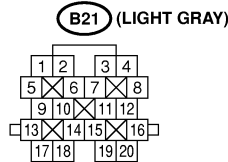
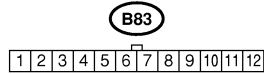
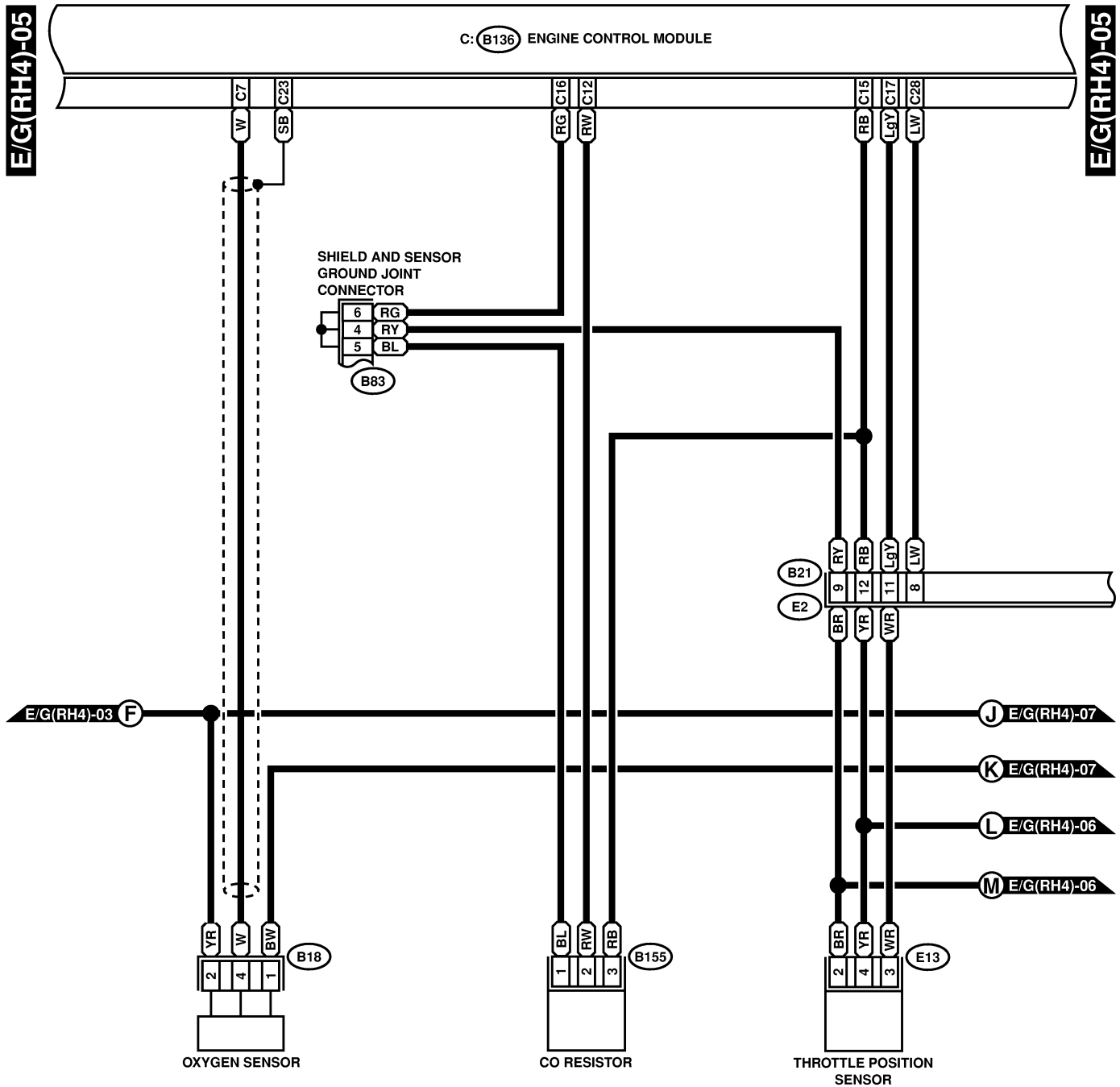

ENGINE ELECTRICAL SYSTEM

Wiring System

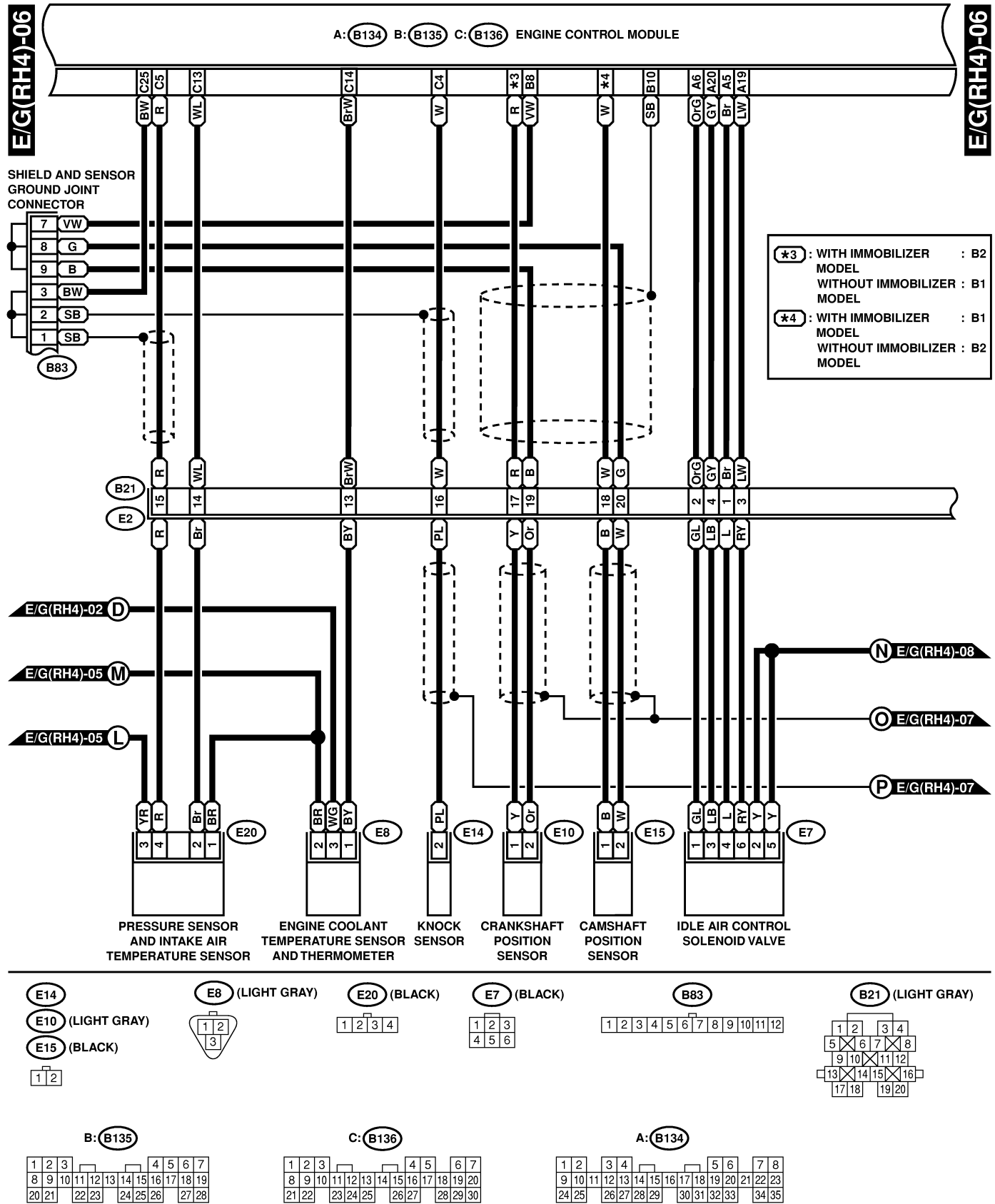

ENGINE ELECTRICAL SYSTEM

Wiring System

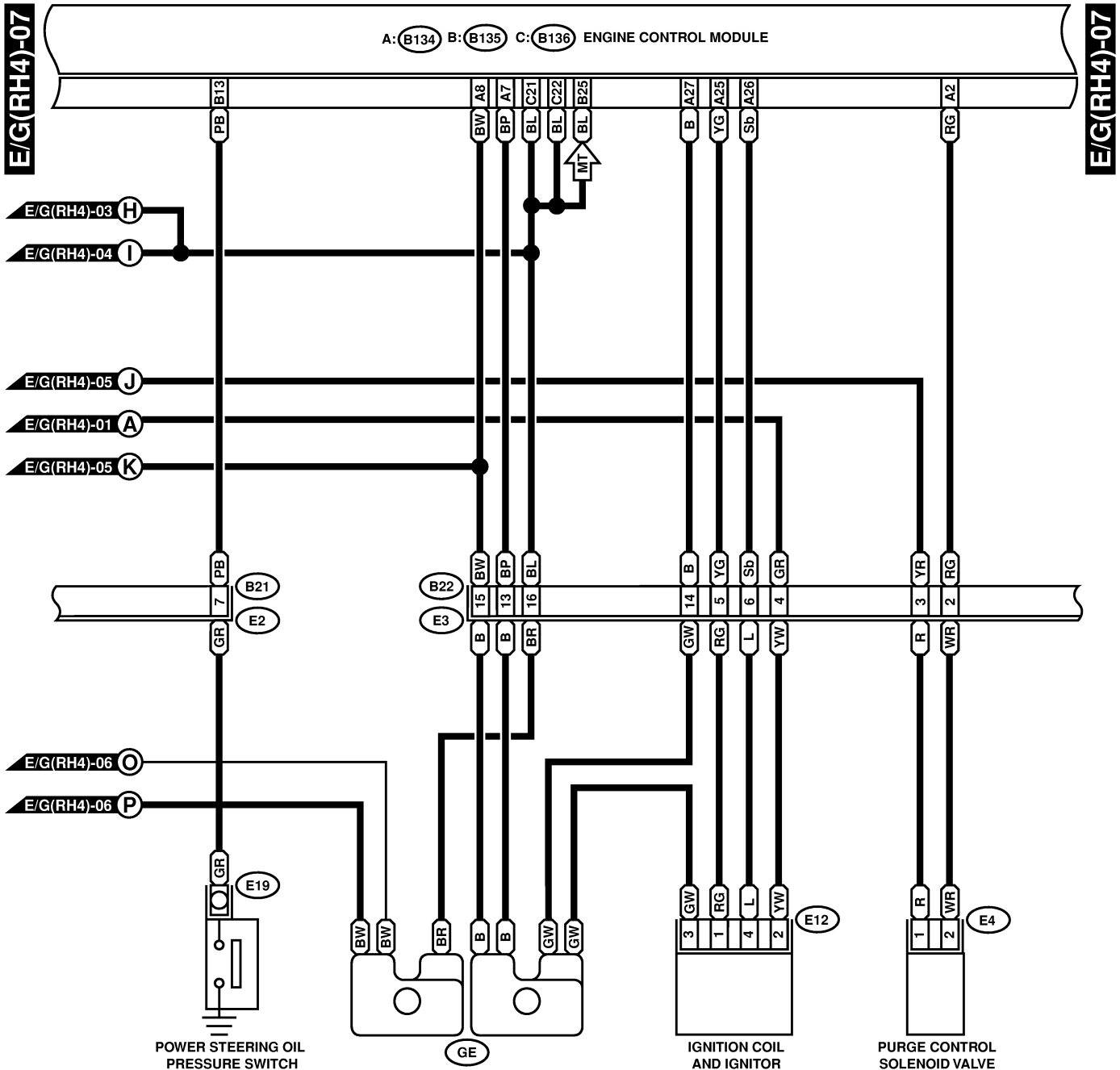

E4 (BLUE)



E12 (DARK GRAY)



B22 (BROWN)



B21 (LIGHT GRAY)

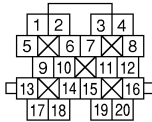

B: B135

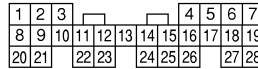

C: B136

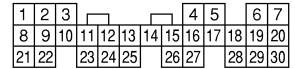

A: B134

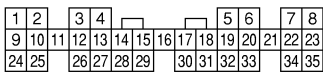

ENGINE ELECTRICAL SYSTEM

Wiring System

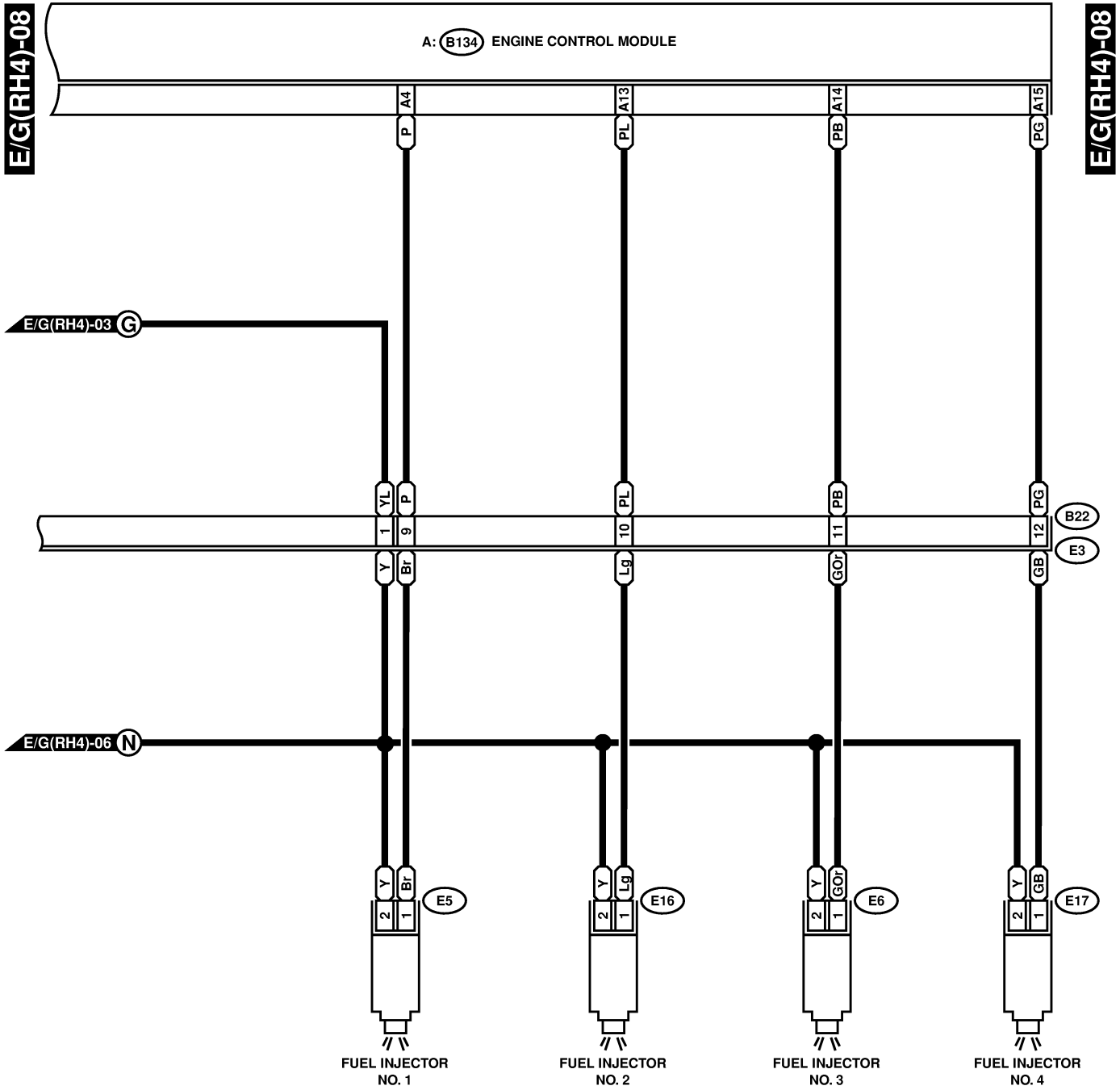

(E5) (LIGHT GRAY)

(E6) (LIGHT GRAY)

(E16) (LIGHT GRAY)

(E17) (LIGHT GRAY)



(B22) (BROWN)



A: (B134)

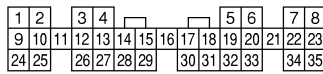

ENGINE ELECTRICAL SYSTEM

Wiring System

5. RHD-H4 WITH OBD MODEL S903482A2112

E/G(R40)-01

E/G(R40)-01

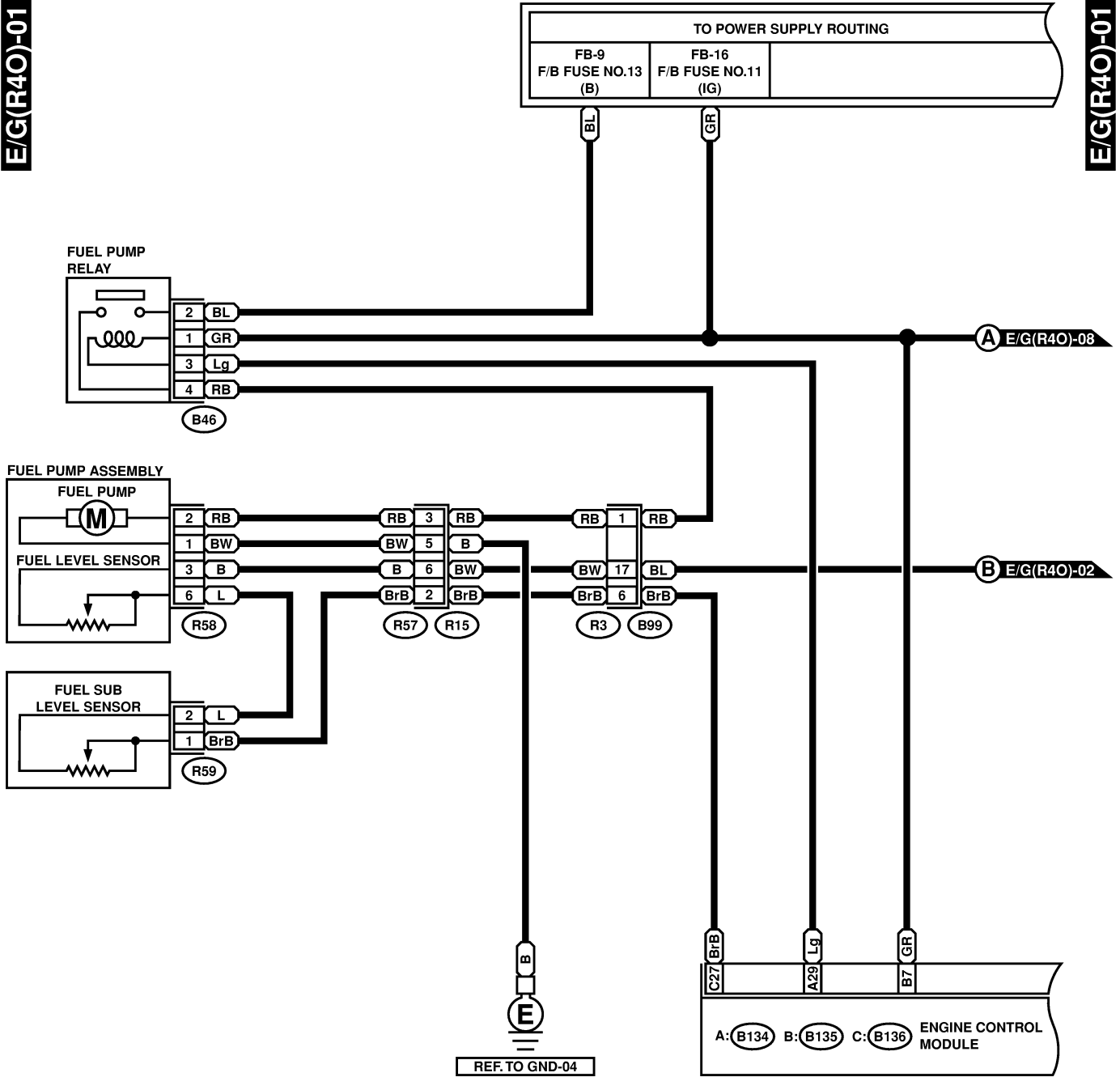

R59



B46 (GREEN)



R57 (BLACK)



R58 (GRAY)



R3

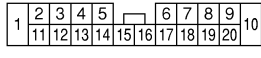

B: B135

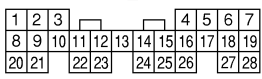

C: B136

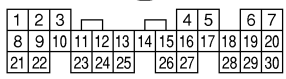

A: B134

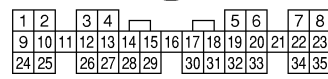

ENGINE ELECTRICAL SYSTEM

Wiring System

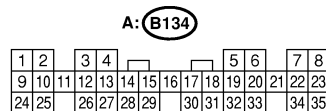
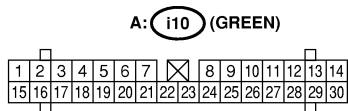
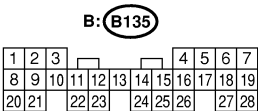
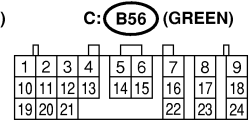
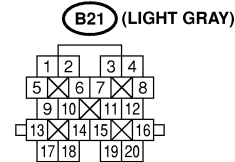
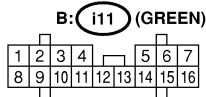
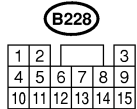
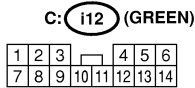
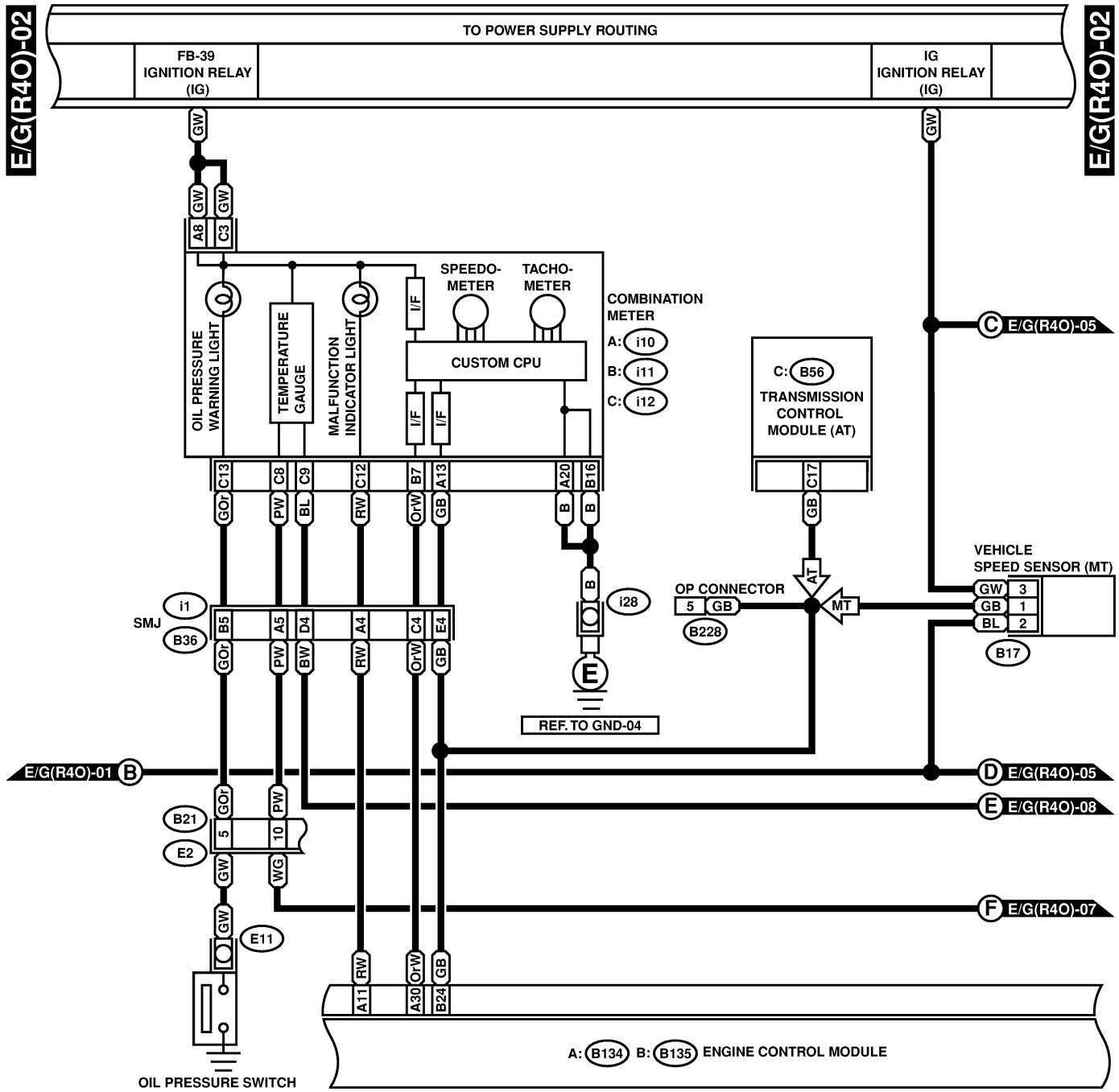

ENGINE ELECTRICAL SYSTEM

Wiring System

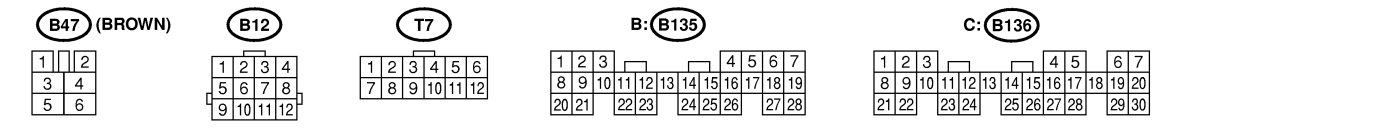
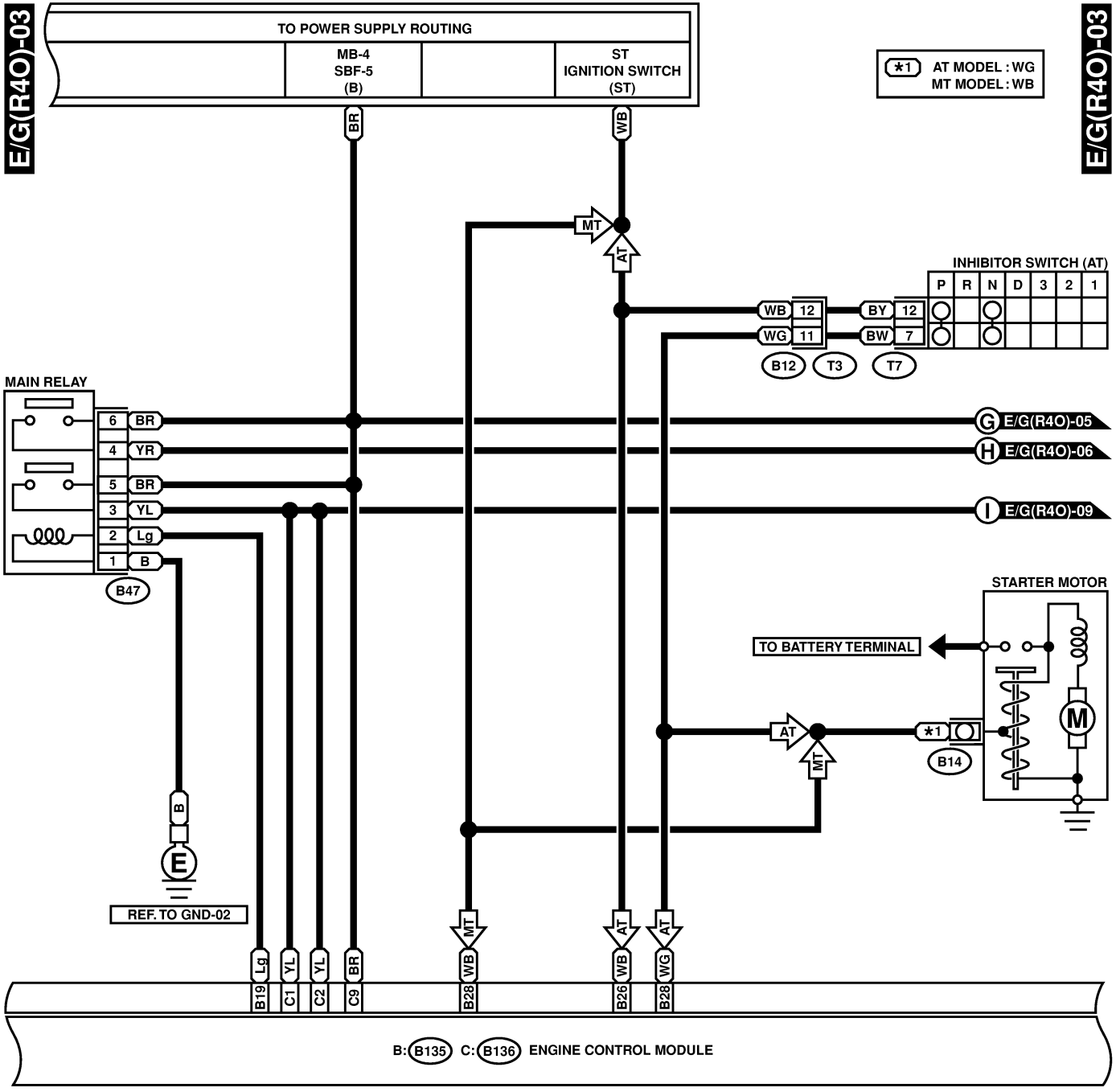

ENGINE ELECTRICAL SYSTEM

Wiring System

E/G(R40)-04

E/G(R40)-04

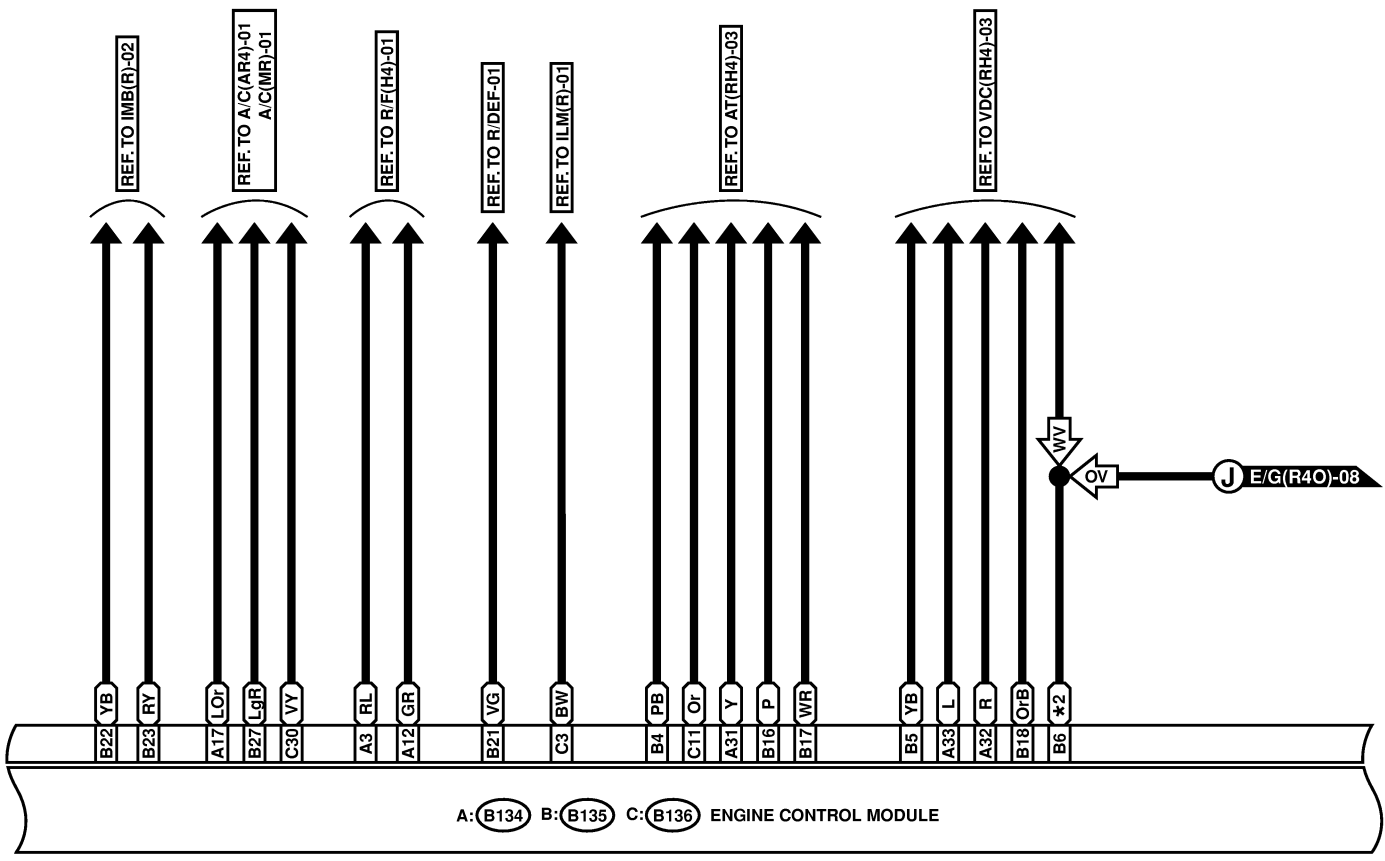
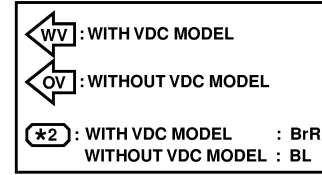

A: **B134** B: **B135** C: **B136** ENGINE CONTROL MODULE

B: **B135**

1	2	3		4	5	6	7				
8	9	10	11	12	13	14	15	16	17	18	19
20	21	22	23	24	25	26	27	28			

C: **B136**

1	2	3		4	5	6	7					
8	9	10	11	12	13	14	15	16	17	18	19	20
21	22	23	24	25	26	27	28	29	30			

A: **B134**

1	2		3	4		5	6	7	8					
9	10	11	12	13	14	15	16	17	18	19	20	21	22	23
24	25	26	27	28	29	30	31	32	33	34	35			

ENGINE ELECTRICAL SYSTEM

Wiring System

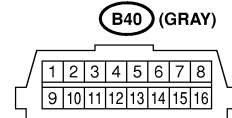
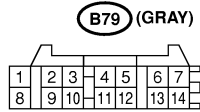
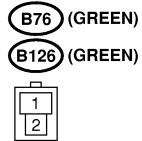
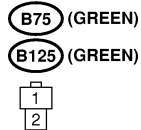
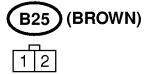
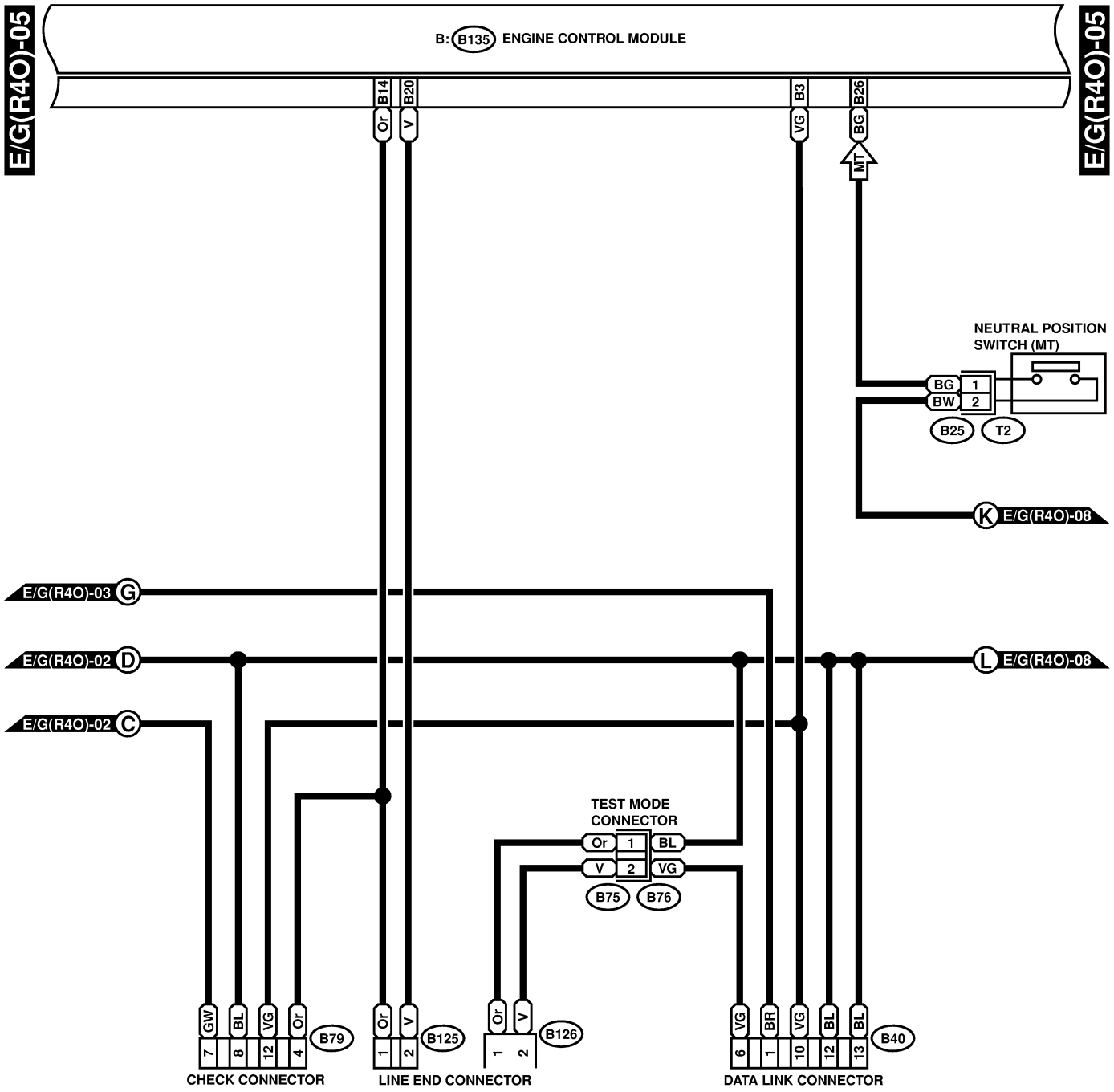

B: (B135)



ENGINE ELECTRICAL SYSTEM

Wiring System

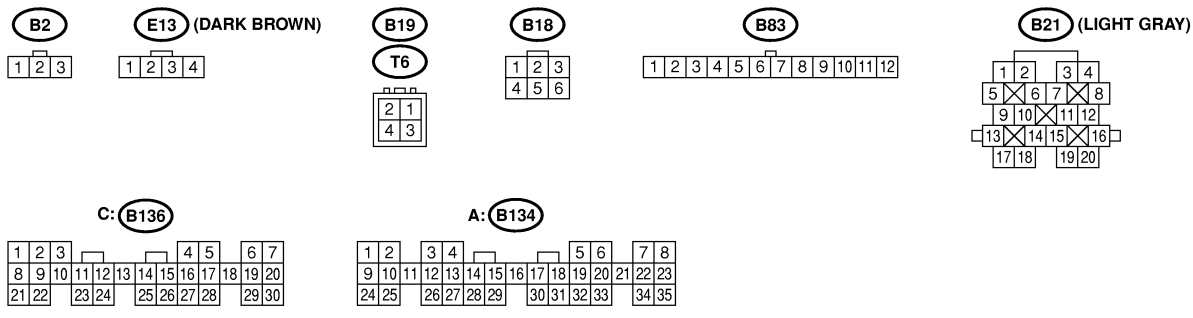
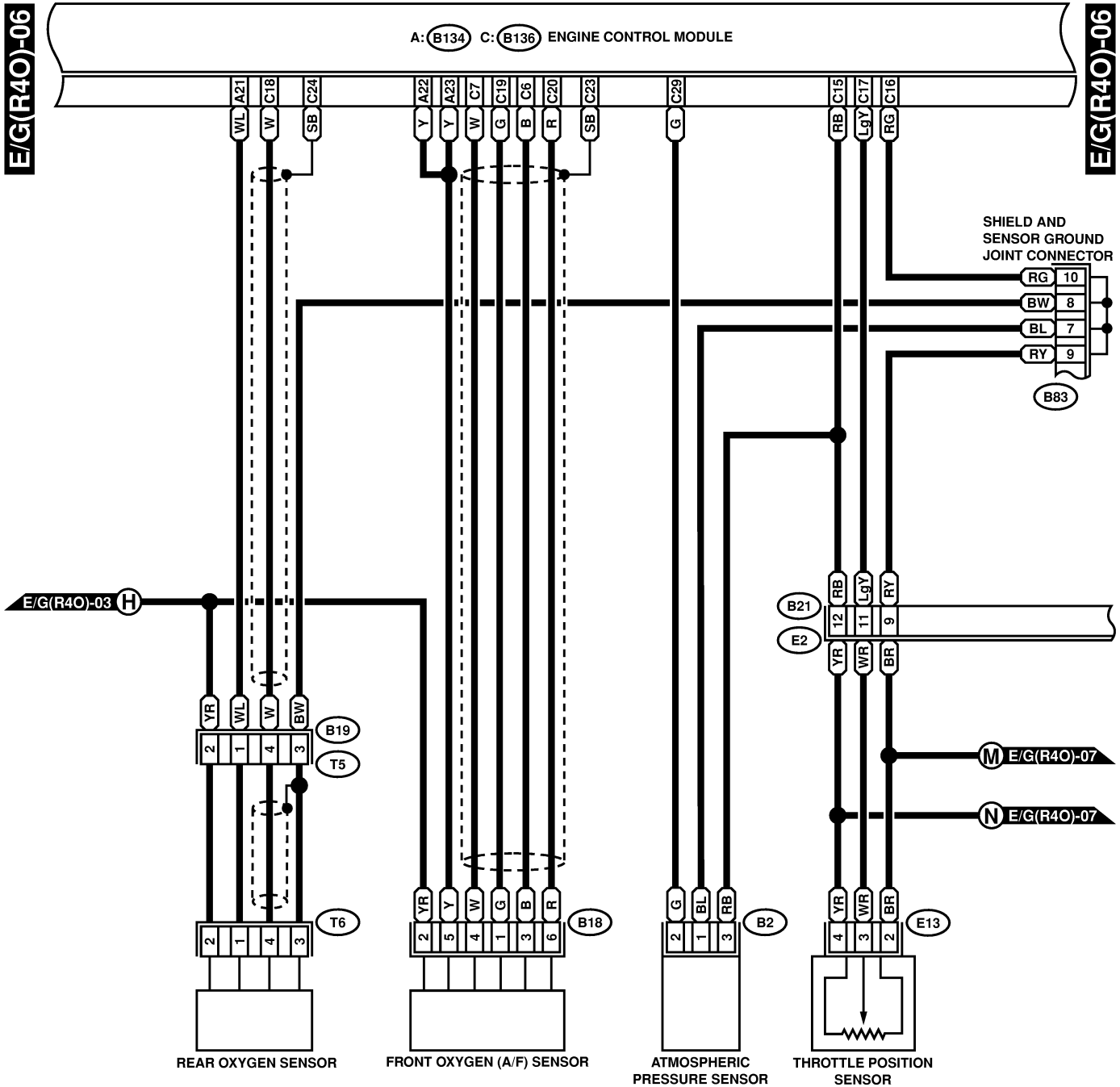

ENGINE ELECTRICAL SYSTEM

Wiring System

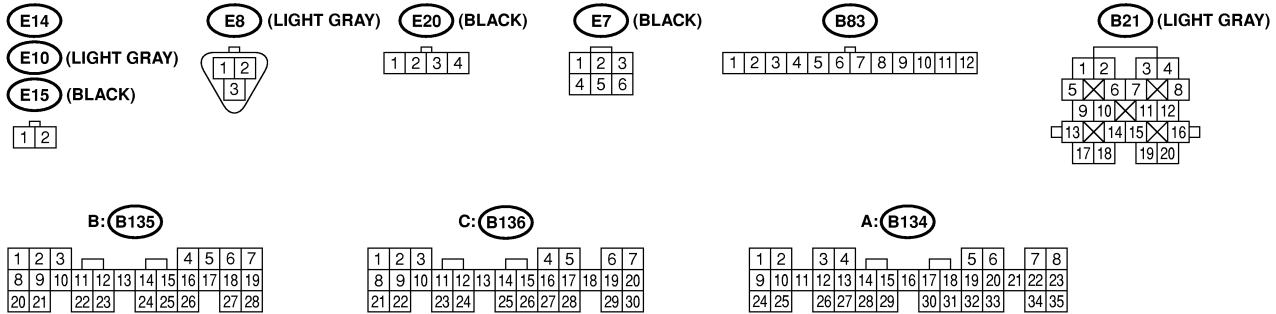
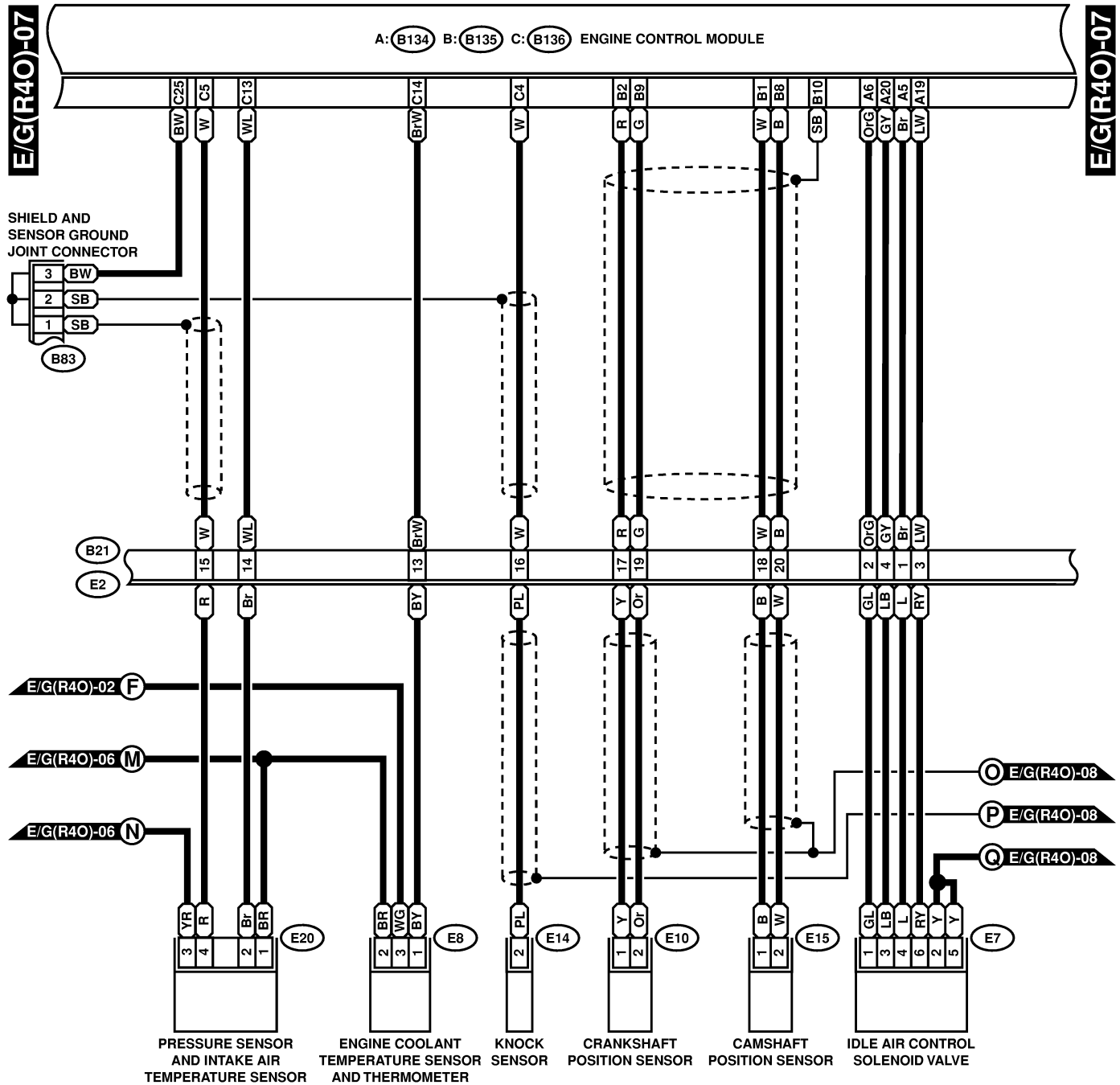

ENGINE ELECTRICAL SYSTEM

Wiring System

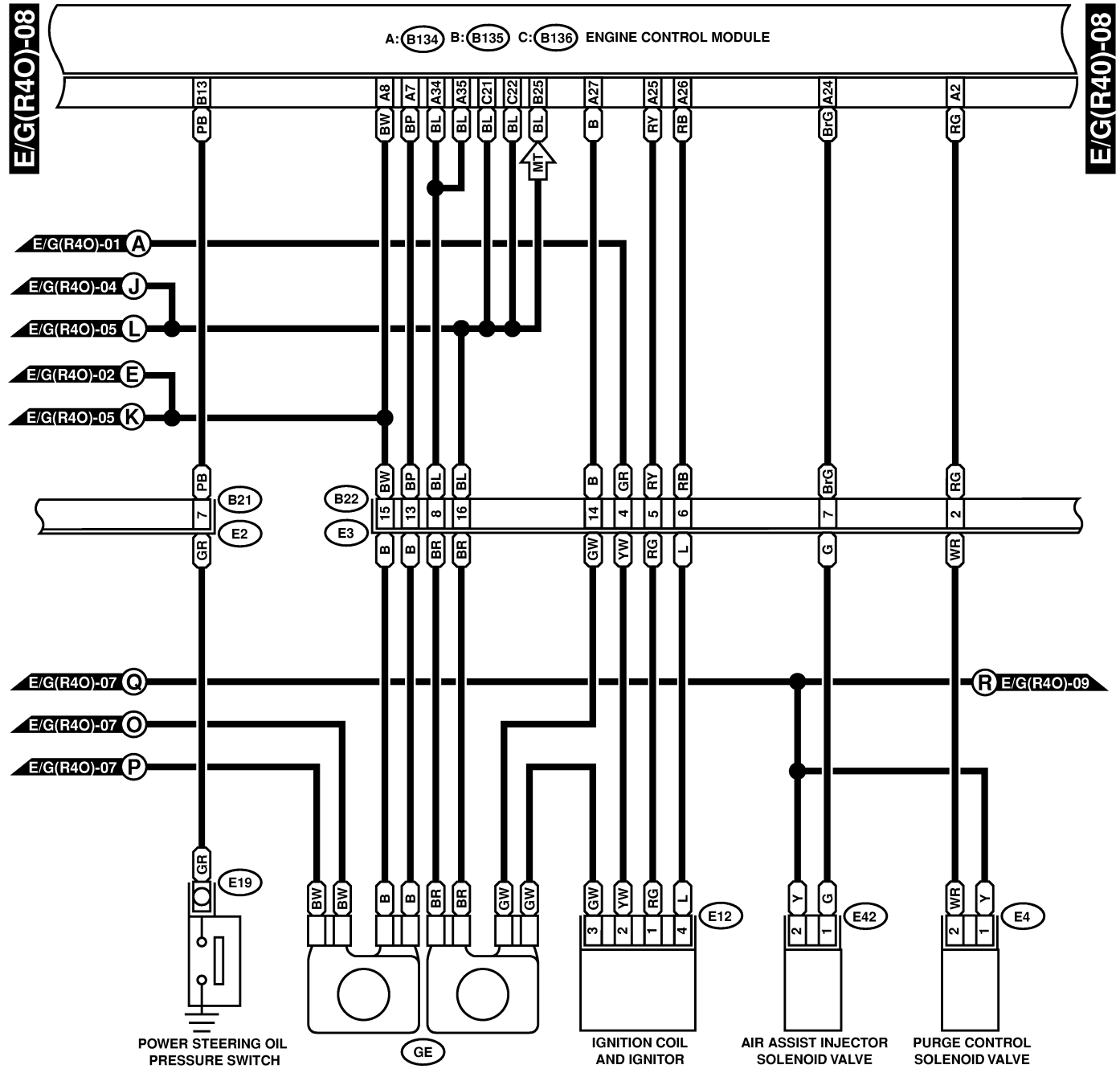

E4 (BLACK)

E12 (DARK GRAY)

B22 (BROWN)

B21 (LIGHT GRAY)

B: B135

E42 (PURPLE)

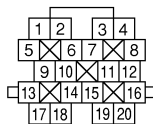

C: B136

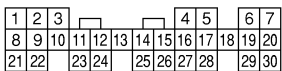

A: B134

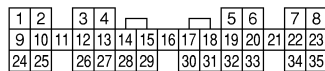

ENGINE ELECTRICAL SYSTEM

Wiring System

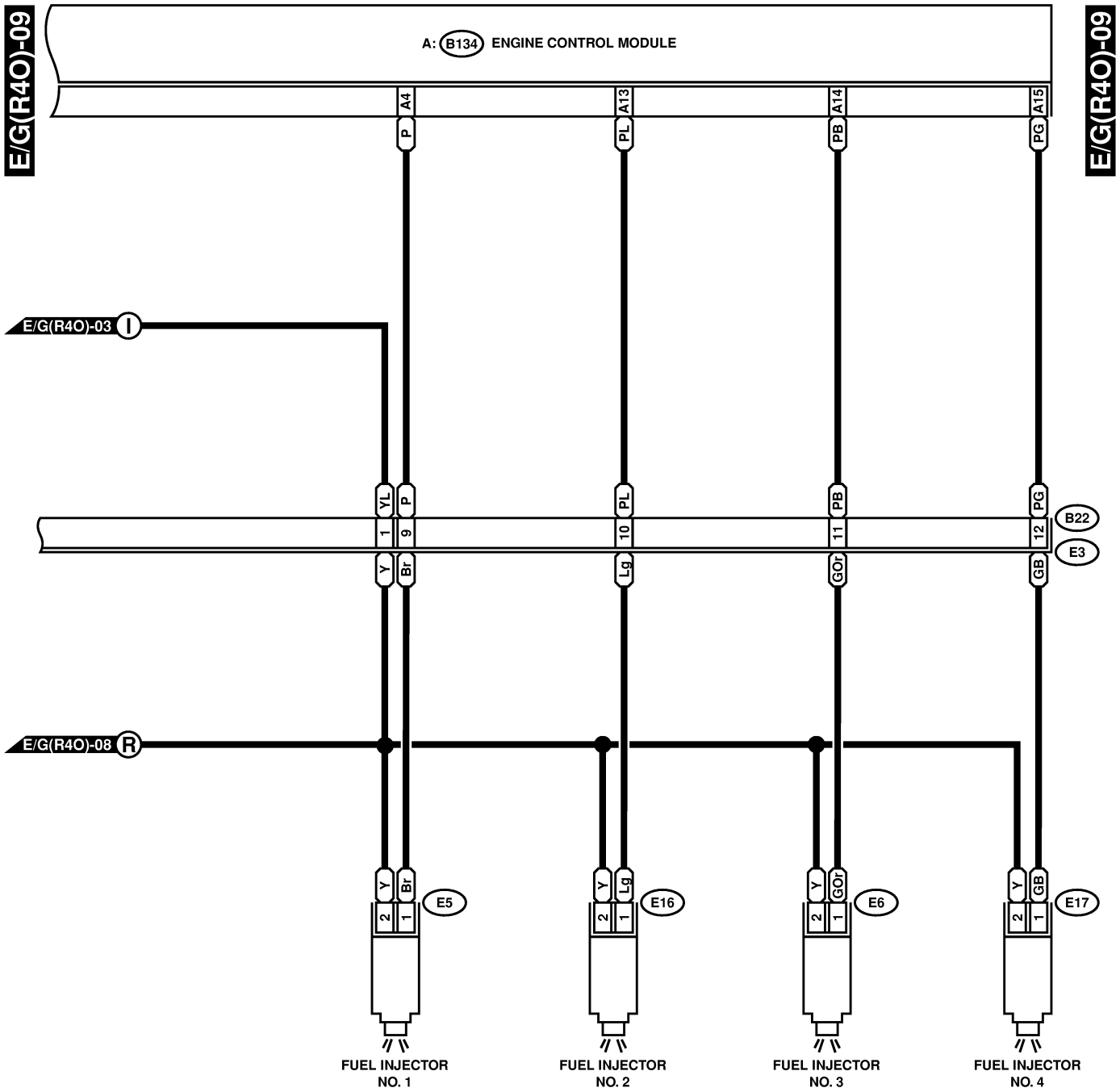

E5 (LIGHT GRAY)

E6 (LIGHT GRAY)

E16 (LIGHT GRAY)

E17 (LIGHT GRAY)



B22 (BROWN)



A: (B134)

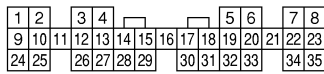

ENGINE ELECTRICAL SYSTEM

Wiring System

6. RHD-H6 MODEL S903482A2113

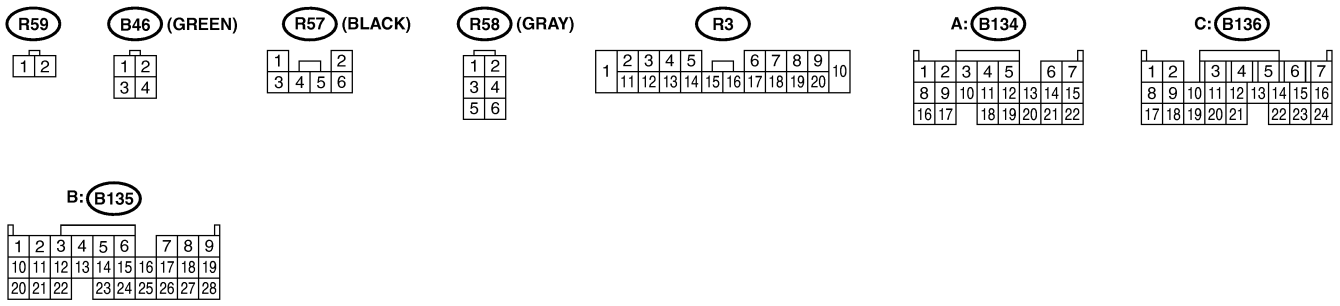
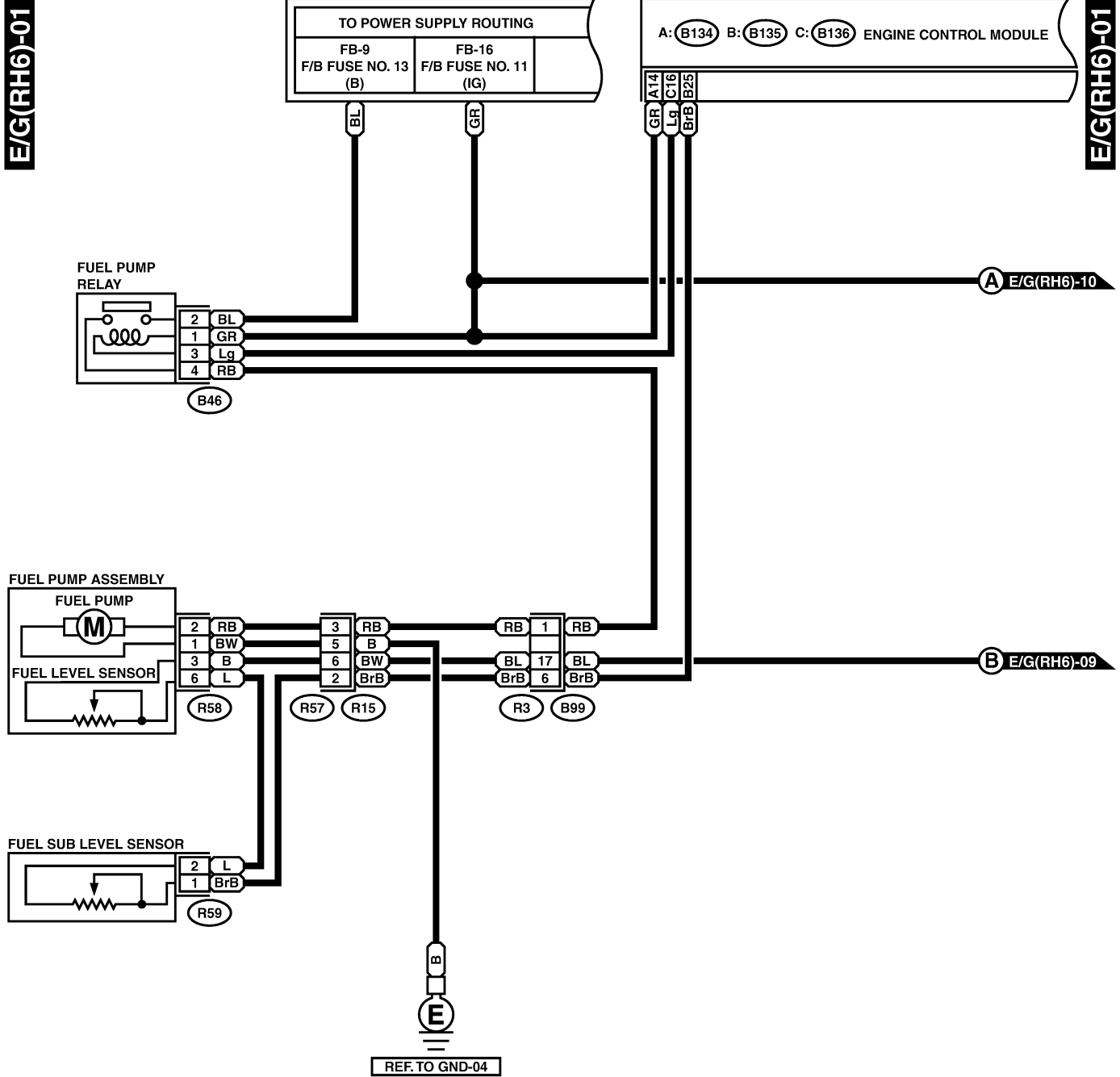

ENGINE ELECTRICAL SYSTEM

Wiring System

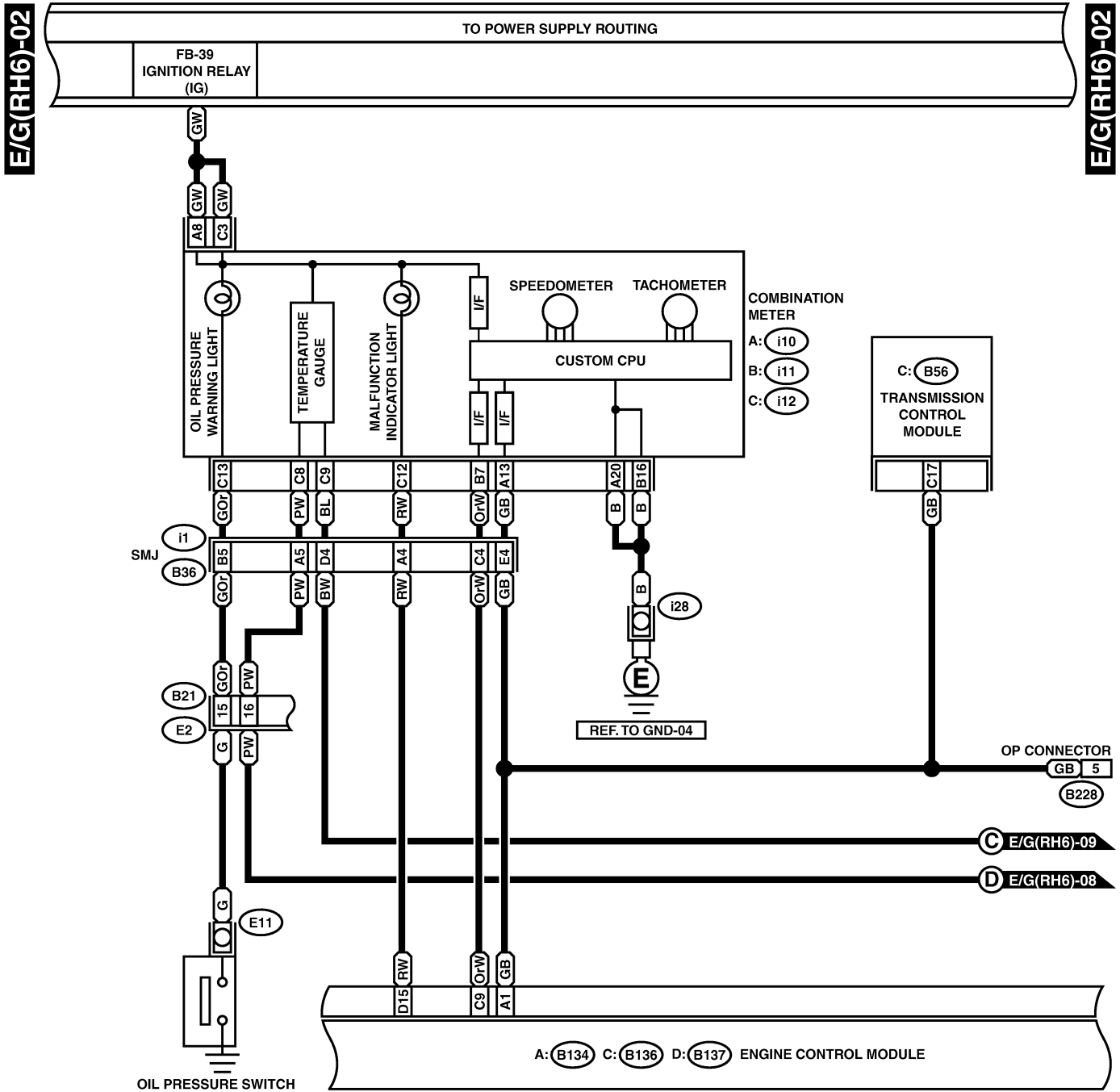

C: i12 (GREEN)

1	2	3	4	5	6
7	8	9	10	11	12
13	14				

B228

1	2	3
4	5	6
7	8	9
10	11	12
13	14	15

B: i11 (GREEN)

1	2	3	4	5	6	7
8	9	10	11	12	13	14
15	16					

B21 (LIGHT GRAY)

1	2	3	4
5	6	7	8
9	10	11	12
13	14	15	16
17	18	19	20

C: B56 (GREEN)

1	2	3	4	5	6	7	8	9
10	11	12	13	14	15	16	17	18
19	20	21				22	23	24

A: B134

1	2	3	4	5	6	7
8	9	10	11	12	13	14
15	16	17	18	19	20	21
22	23	24				

C: B136

1	2	3	4	5	6	7
8	9	10	11	12	13	14
15	16	17	18	19	20	21
22	23	24				

A: i10 (GREEN)

1	2	3	4	5	6	7	8	9	10	11	12	13	14
15	16	17	18	19	20	21	22	23	24	25	26	27	28
29	30												

D: B137

1	2	3	4	5	6	7	8	9
10	11	12	13	14	15	16	17	18
19	20	21				27	28	29
30	31							

ENGINE ELECTRICAL SYSTEM

Wiring System

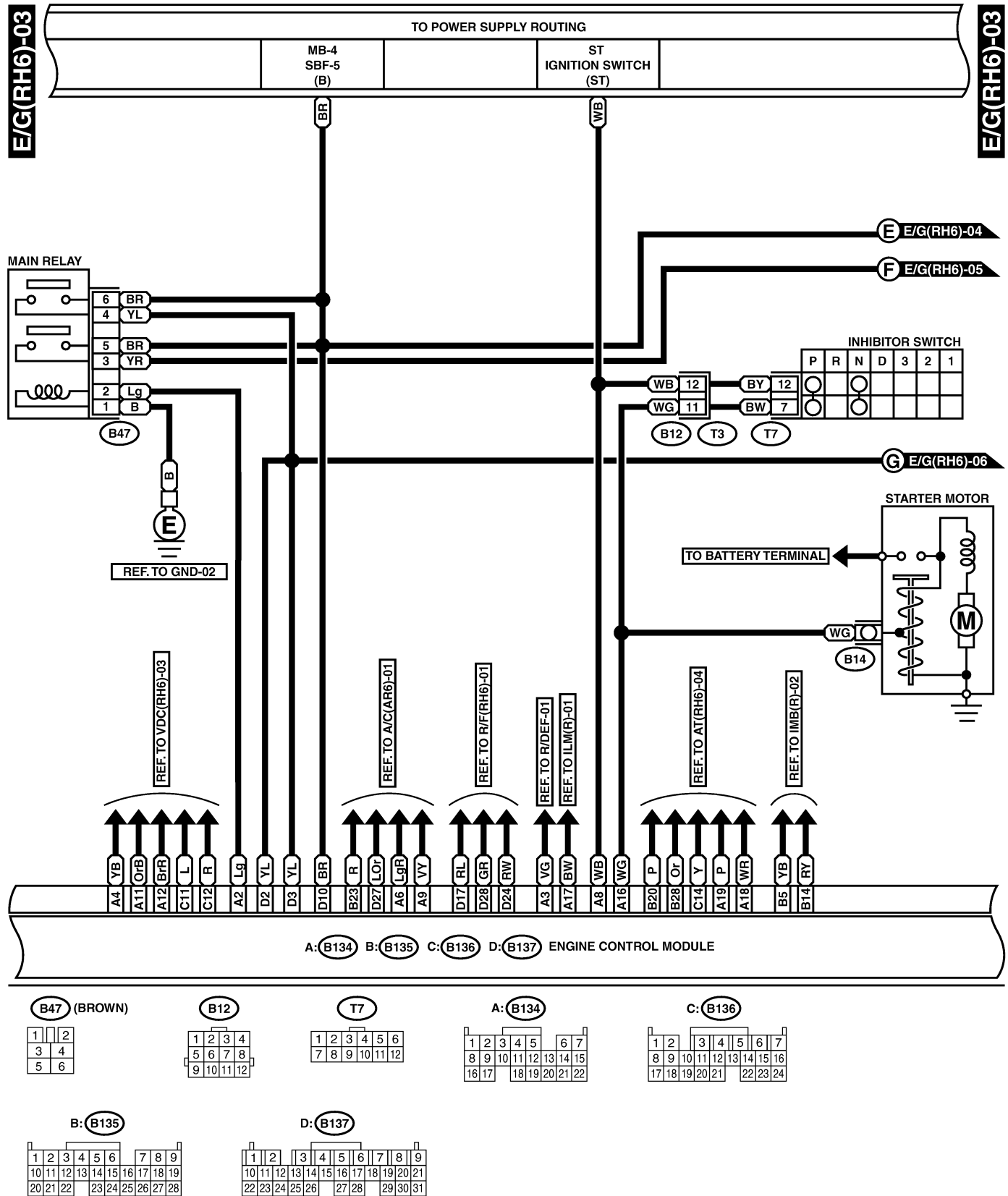

ENGINE ELECTRICAL SYSTEM

Wiring System

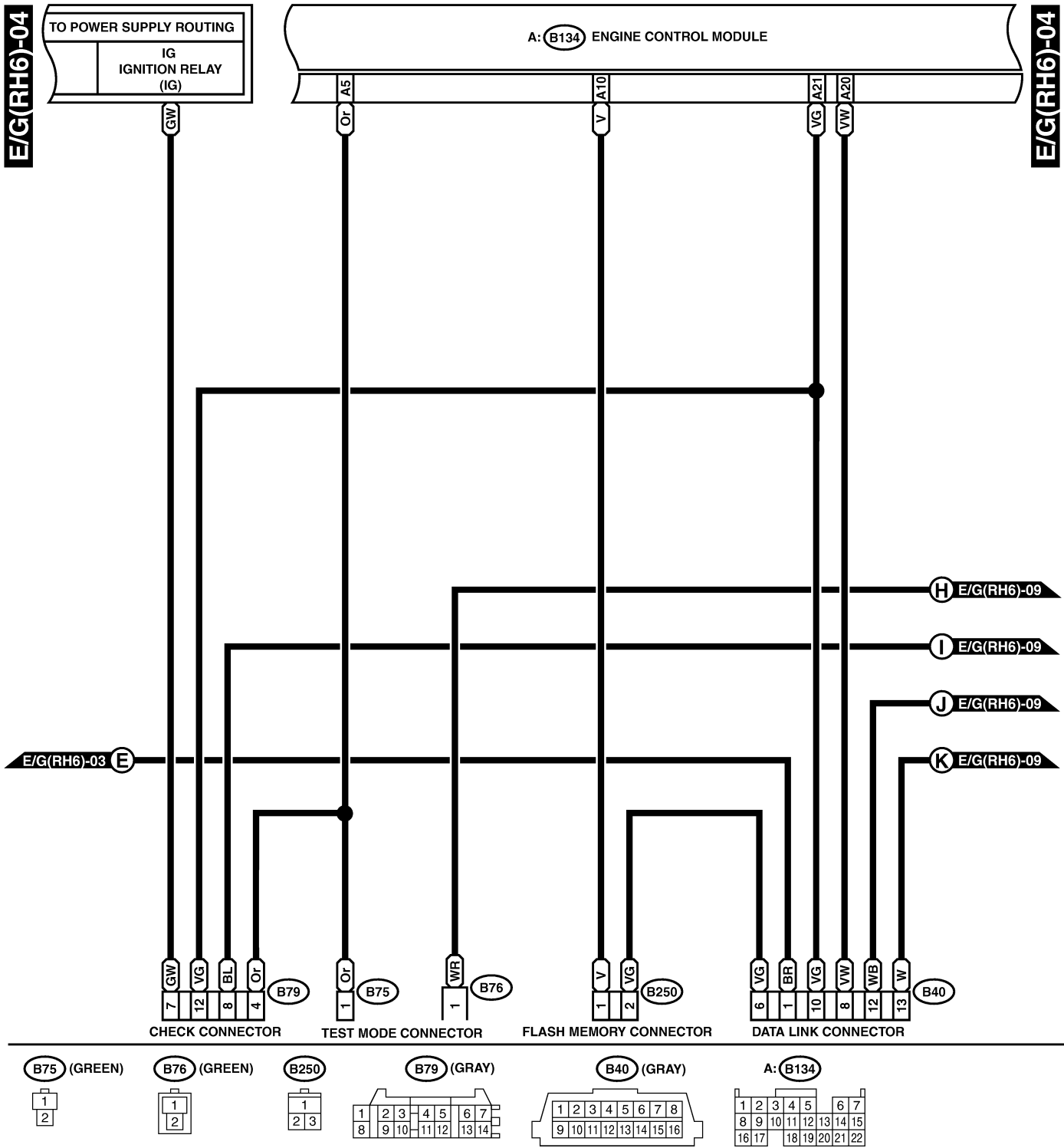

ENGINE ELECTRICAL SYSTEM

Wiring System

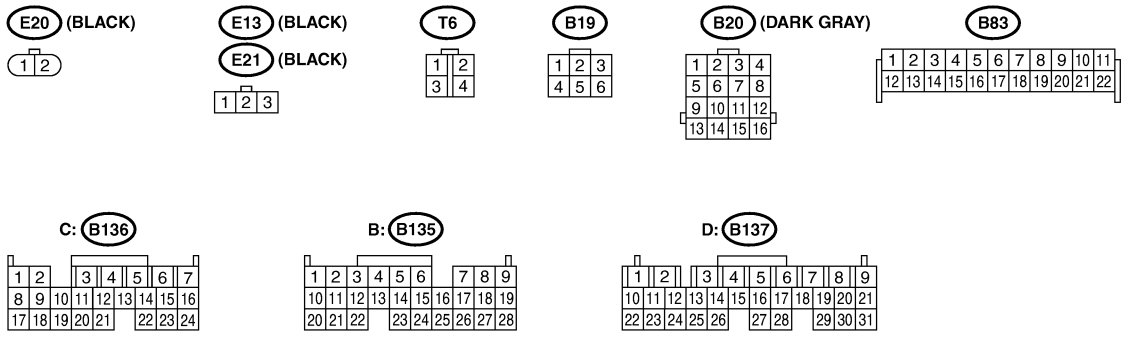
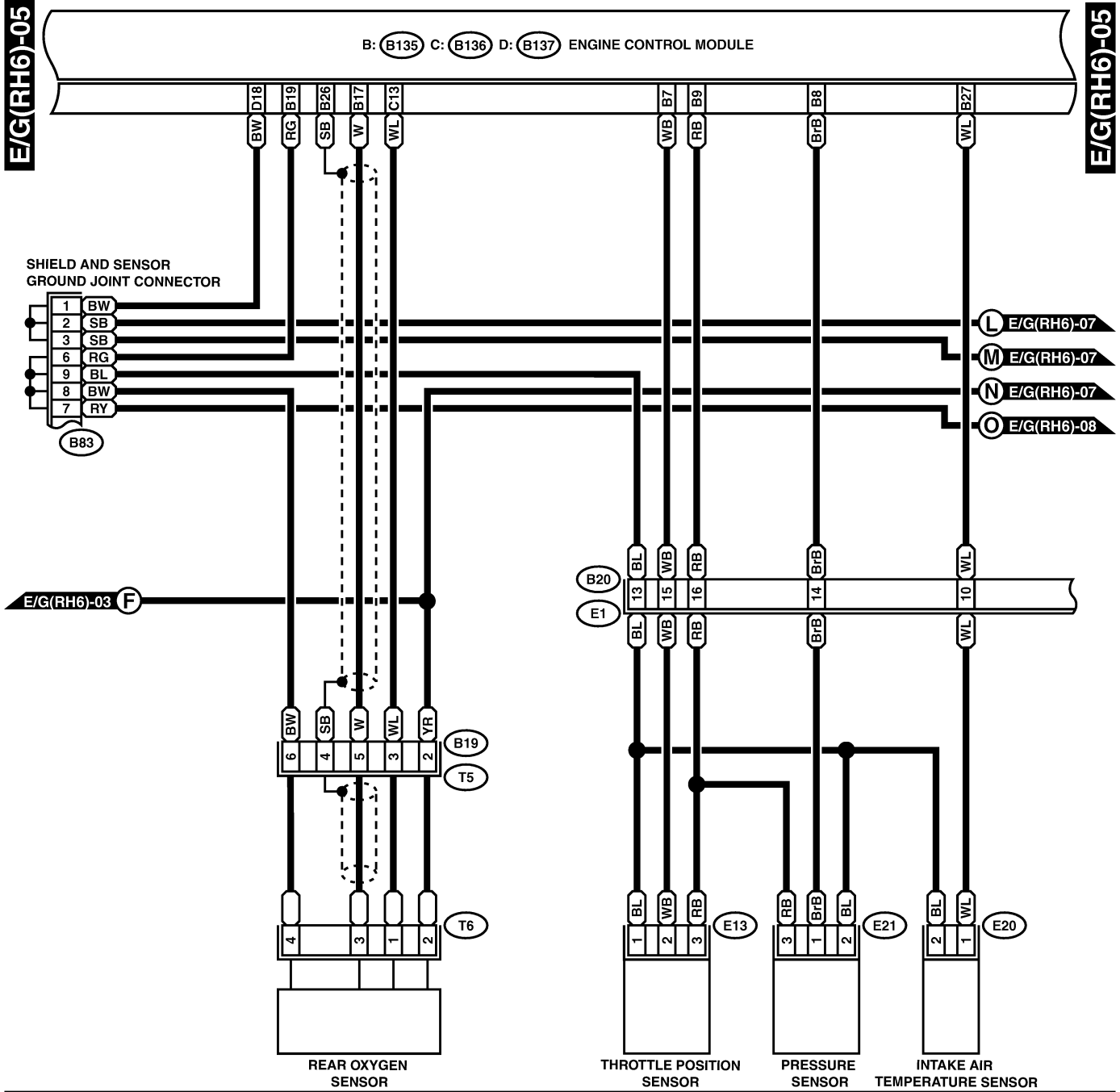

ENGINE ELECTRICAL SYSTEM

Wiring System

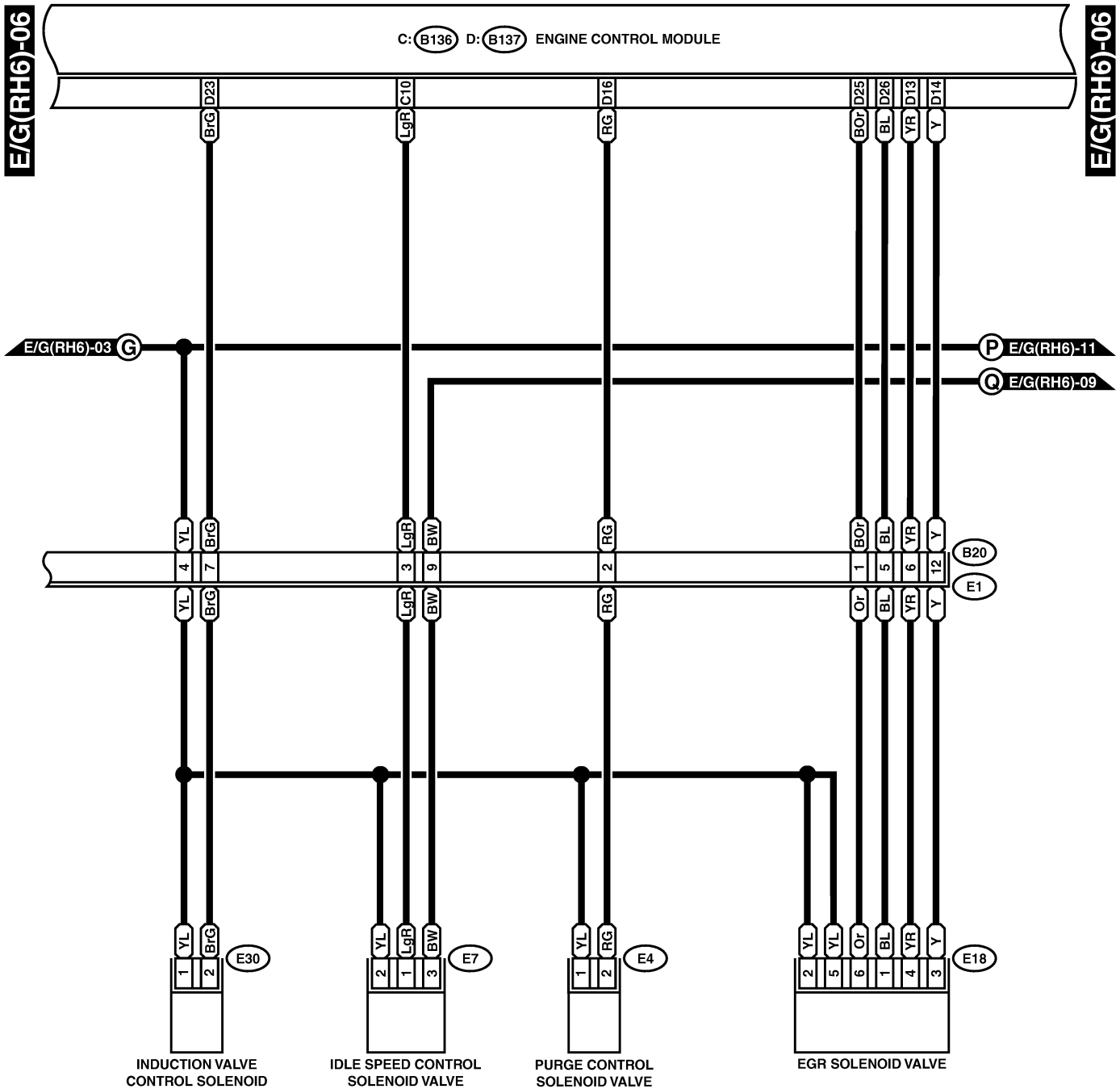

E30 (BROWN) E4 (BLACK) E7 (GRAY) E18 (GRAY) B20 (DARK GRAY)

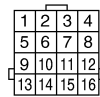

C: B136

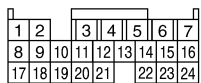

D: B137

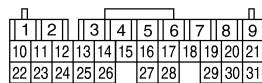

ENGINE ELECTRICAL SYSTEM

Wiring System

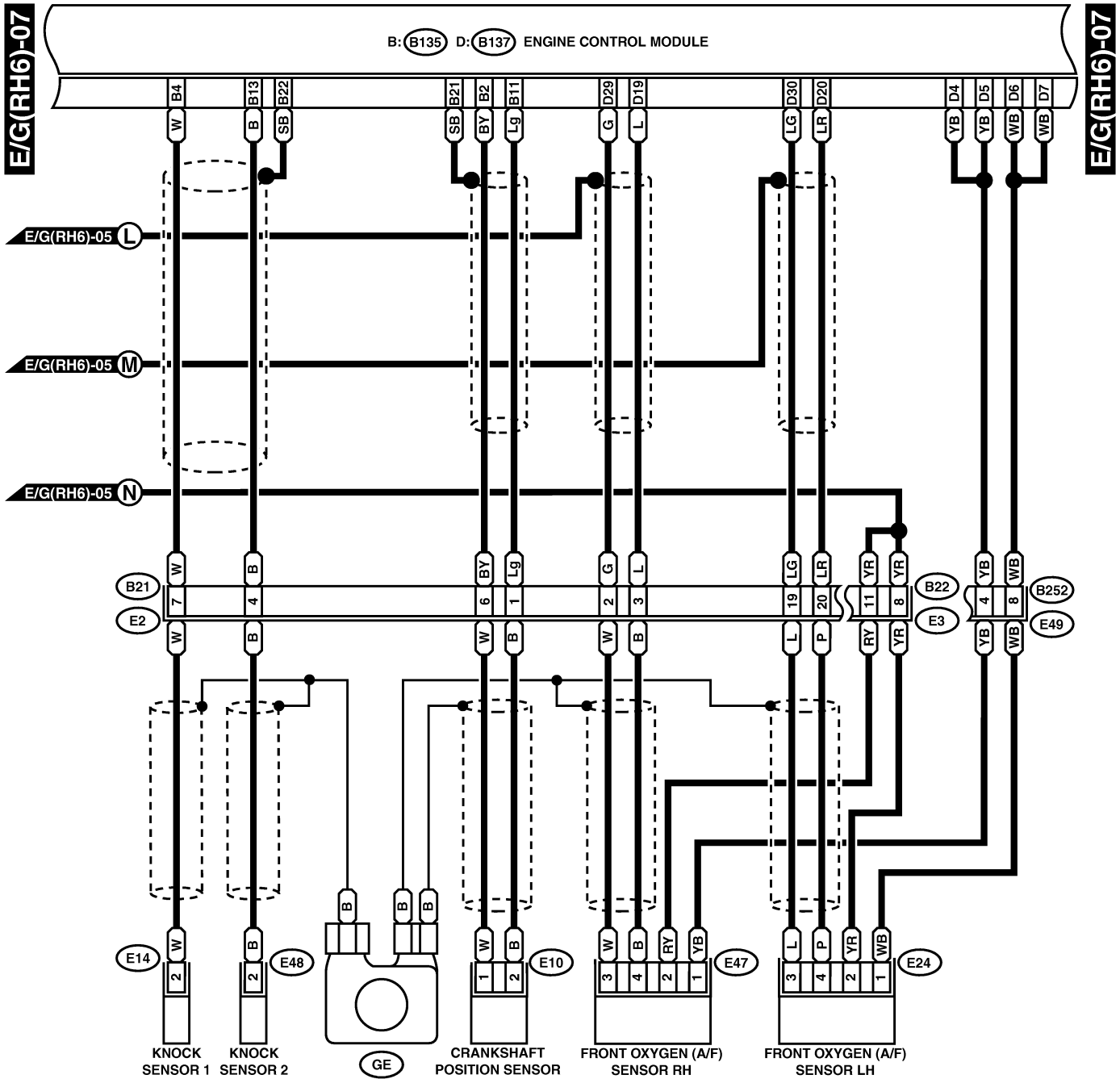

E14 (BLUE)

E48 (BLUE)



E10 (GRAY)



E24 (DARK GRAY)

E47 (DARK GRAY)



B252 (DARK GRAY)

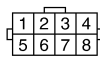

B22 (BROWN)



B21 (LIGHT GRAY)

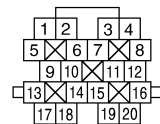

B: B135

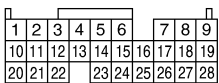

D: B137

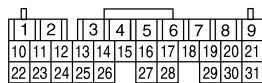

ENGINE ELECTRICAL SYSTEM

Wiring System

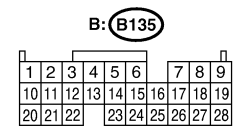
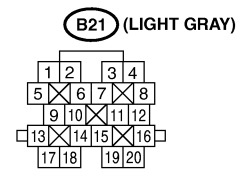
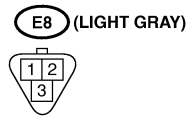
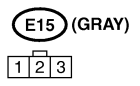
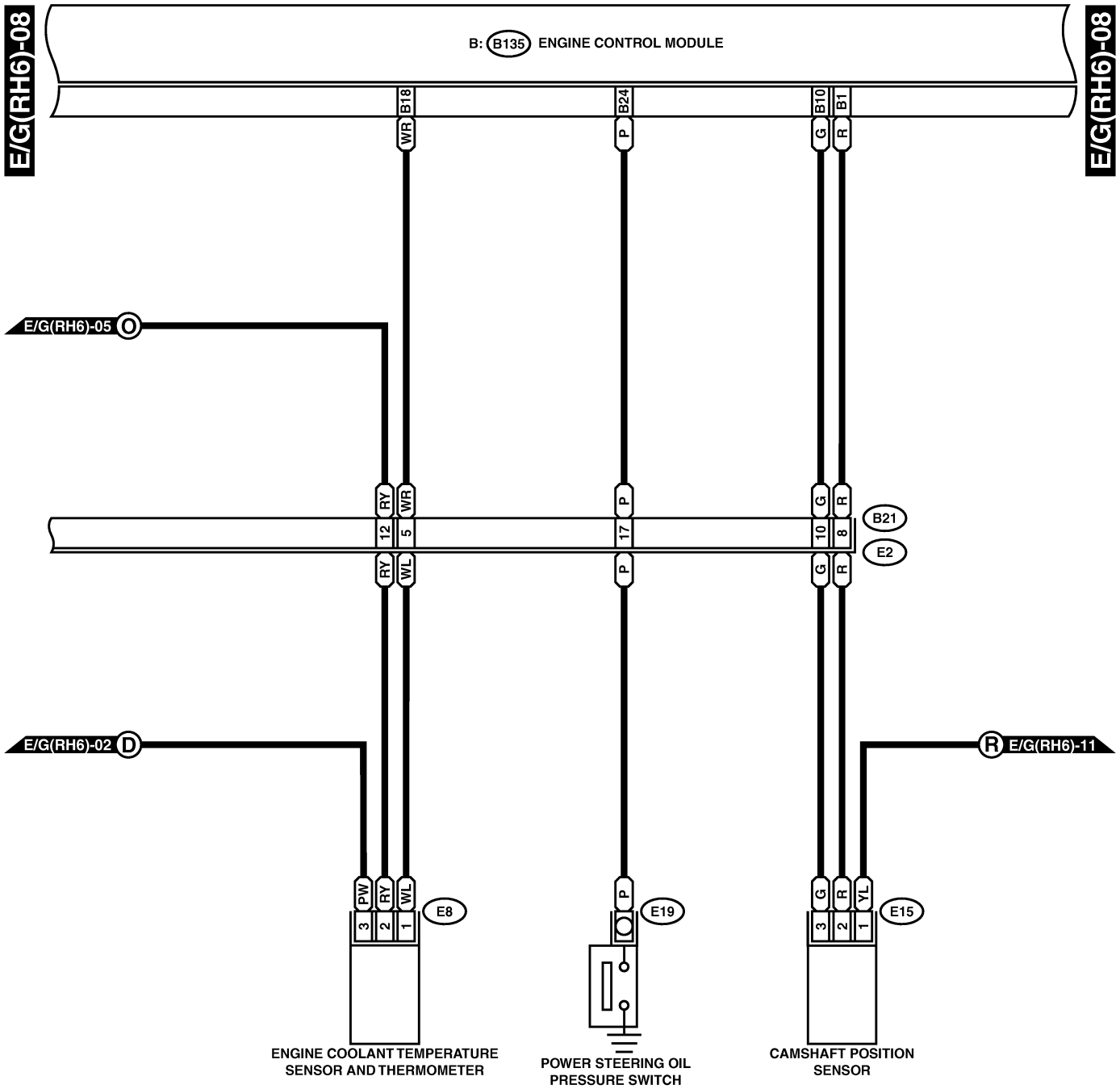

ENGINE ELECTRICAL SYSTEM

Wiring System

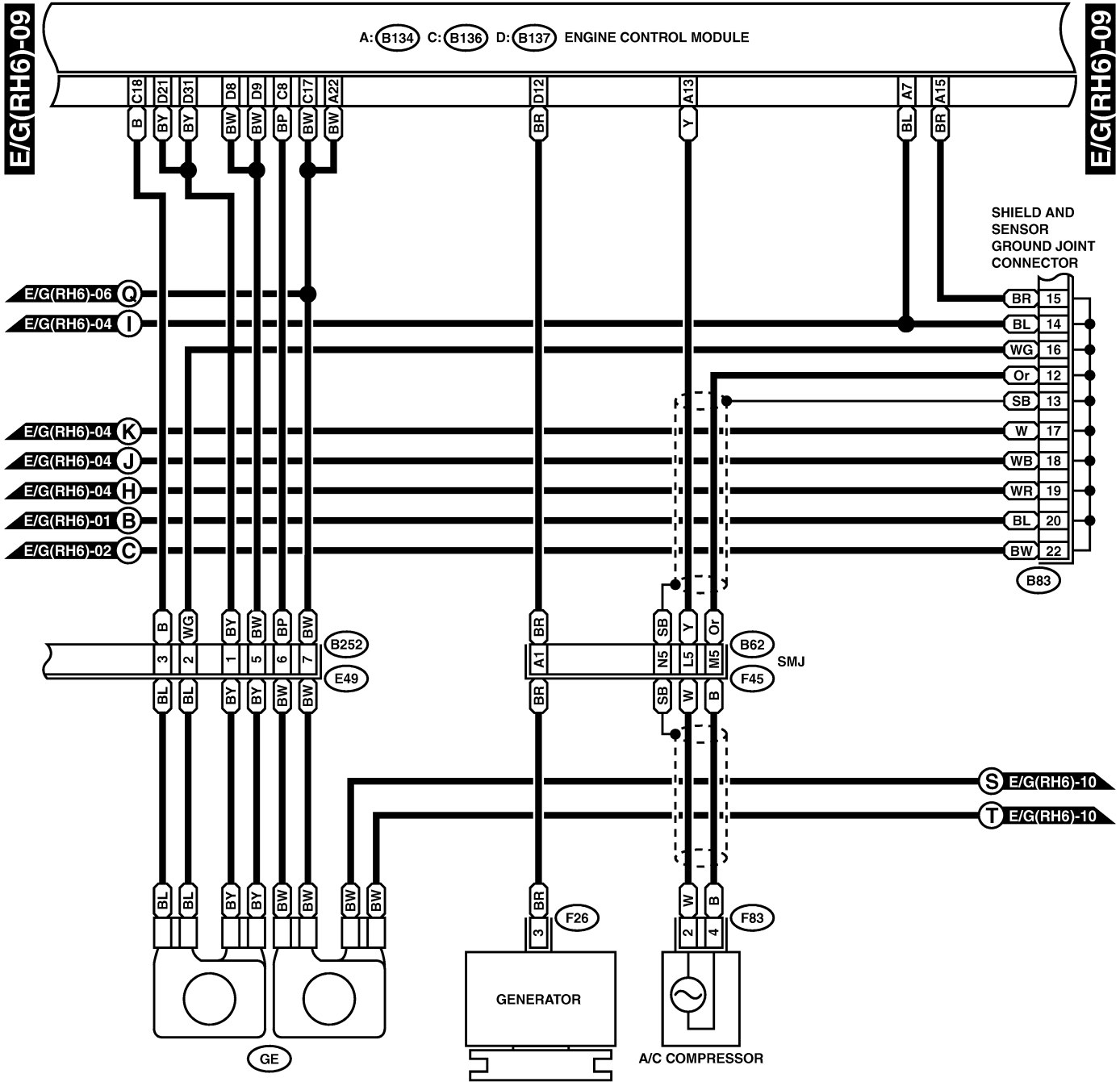

F26 (GREEN)



F83 (GRAY)



B252 (DARK GRAY)

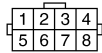

B83

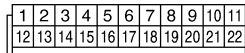

A: B134

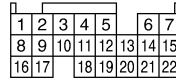

C: B136

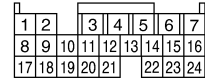

D: B137

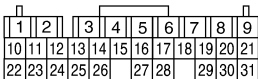

ENGINE ELECTRICAL SYSTEM

Wiring System

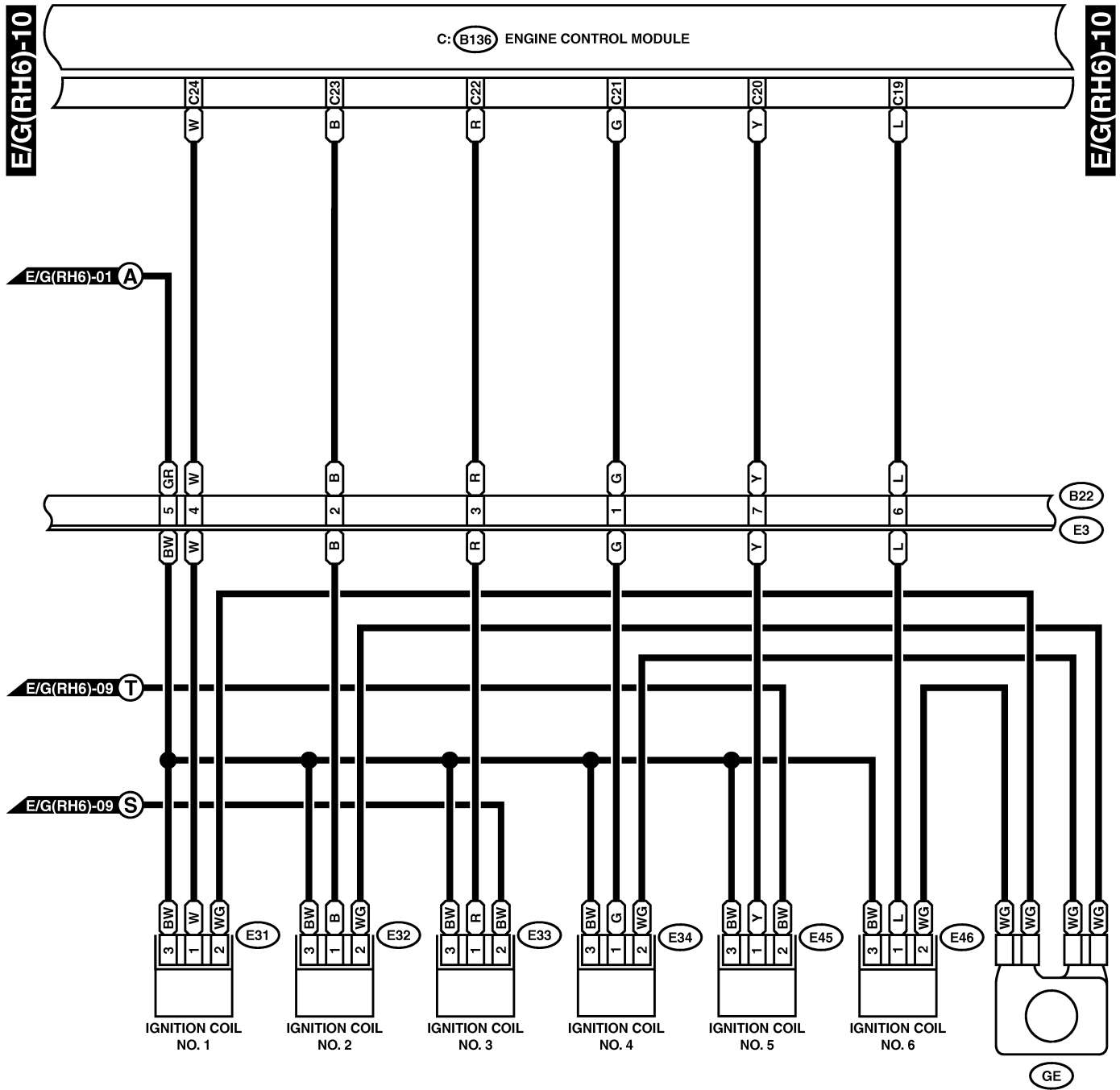

(BLACK) **E31** **E32**
 (BLACK) **E33** **E34** (BLACK)
E45 **E46** (BLACK)

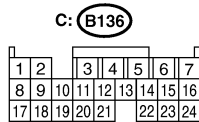
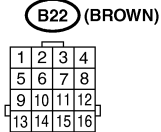

ENGINE ELECTRICAL SYSTEM

Wiring System

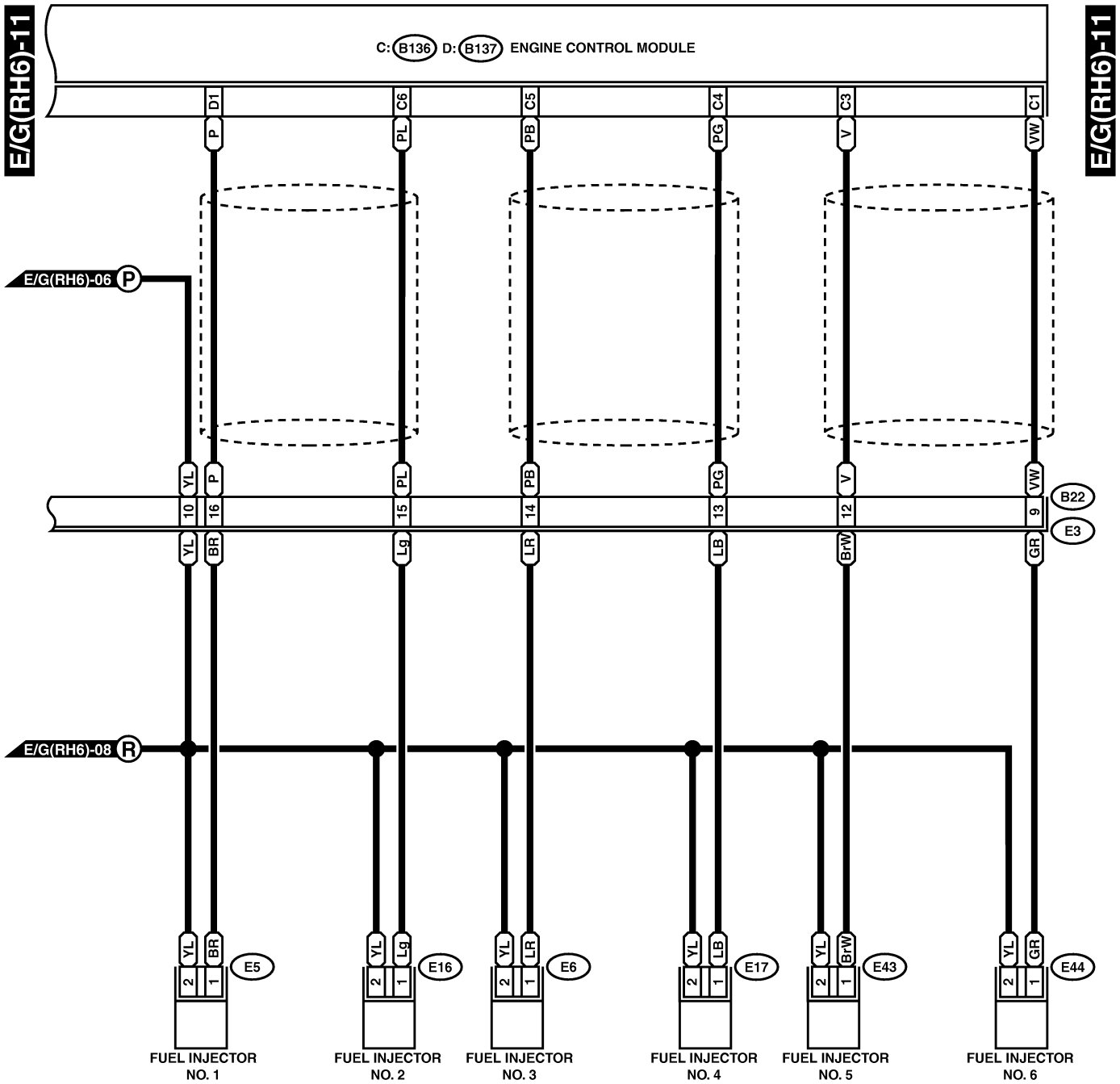

(GRAY) (E5) (E6) (GRAY)

(GRAY) (E16) (E17) (GRAY)

(GRAY) (E43) (E44) (GRAY)



(B22) (BROWN)



C: (B136)

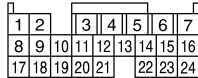

D: (B137)

