

## 2. Air Line

### A: GENERAL

The air filtered by the air cleaner enters the throttle body where it is regulated in the volume by the throttle valve and then enters the intake manifold. It is then distributed to each cylinder where the air is mixed with fuel injected by the injector. During idling operation, air flows into the cylinder through the idle air control solenoid valve, bypassing the throttle valve. This enables controlling the engine idling speed properly.

### B: INTAKE MANIFOLD PRESSURE SENSOR

- The intake manifold pressure sensor is attached to the top of the throttle body, and continuously sends to the engine control module (ECM) voltage signals that are proportional to intake manifold absolute pressures. The ECM controls the fuel injection and ignition timing based on the intake manifold absolute pressure signals in addition to other signals from many sensors and other control modules.

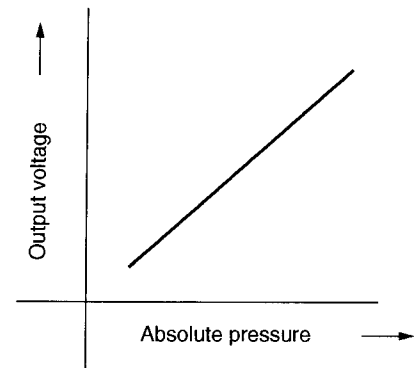
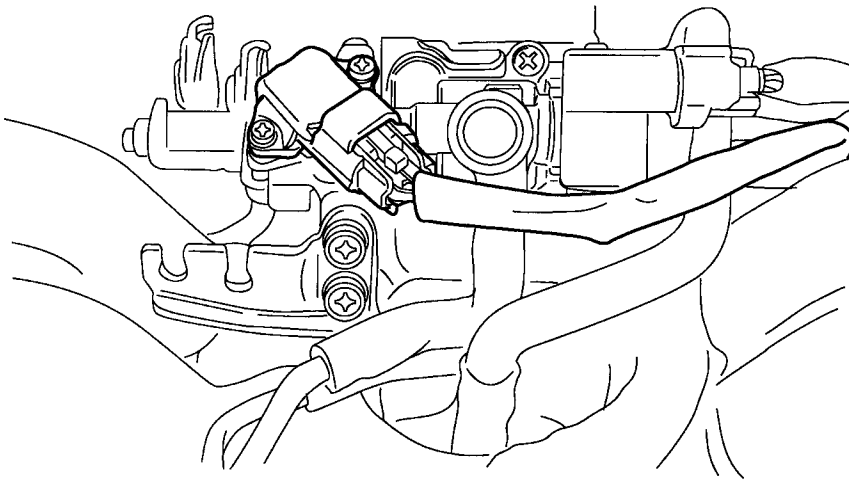

B2H3905A

### C: THROTTLE BODY

In response to operation of the accelerator pedal, the throttle valve in the throttle body opens/closes to regulate the volume of the air drawn into the combustion chamber.

During idling, the throttle valve is almost fully closed and the volume of air passing through the throttle body is less than that passing through the idle air control solenoid valve.

More than half of the air necessary for idling is supplied to the intake manifold via the idle air control solenoid valve which controls properly the engine idling speed, so the idling speed needs not be adjusted.

### D: THROTTLE POSITION SENSOR

- The throttle position sensor is mounted in the throttle body and linked to the throttle valve.
- The throttle position sensor sends the ECM voltage signal corresponding to the opening of the throttle valve. When the sensor's output voltage exceeds a predetermined level, the ECM interprets it as complete closure of the throttle valve. When the output voltage is at another predetermined level, the ECM recognizes that the throttle valve is at a wide open position. Since the output characteristics of the sensor change over years, the ECM is provided with a learning function to be able to interpret signals into throttle valve angles always correctly.

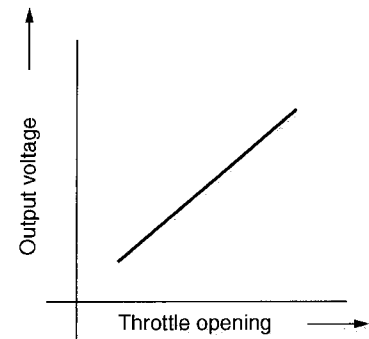
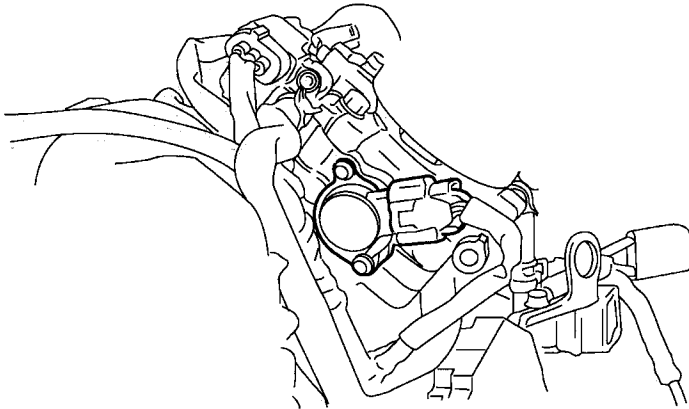

B2H3906A

### E: IDLE AIR CONTROL SOLENOID VALVE

- The idle air control solenoid valve is located in the throttle body and regulates the amount of intake air that flows bypassing the throttle valve into the intake manifold during engine idling. It is activated by a signal from the ECM in order to maintain the engine idling speed at a target speed.
- The idle air control solenoid valve is a solenoid-actuated rotary valve consisting of a coil, rotary valve, spring and housing. The housing is an integral part of the throttle body and provided with a bypass air port whose opening area is changed by the rotary valve.

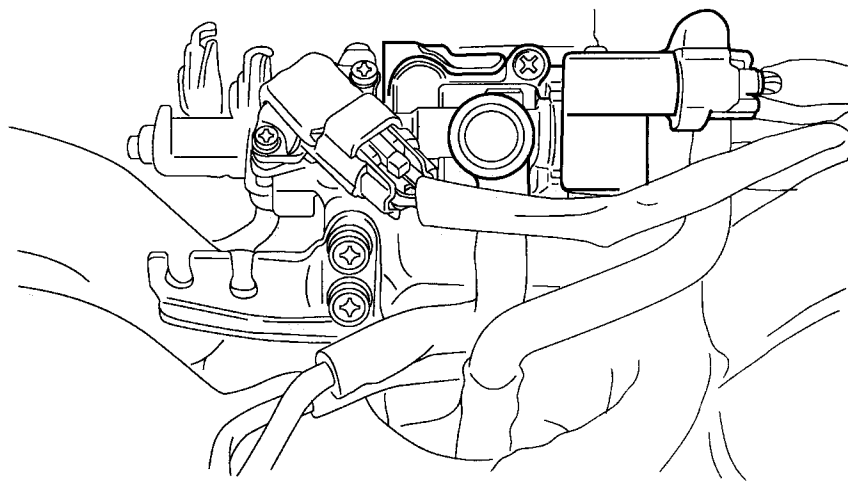

B2H3907

## F: INTAKE AIR TEMPERATURE SENSOR

- The intake air temperature sensor is located in the air cleaner case and detects the temperature of the intake air introduced through the air intake duct. The ECM uses the resistance signal from the sensor to correct the fuel injection amount.

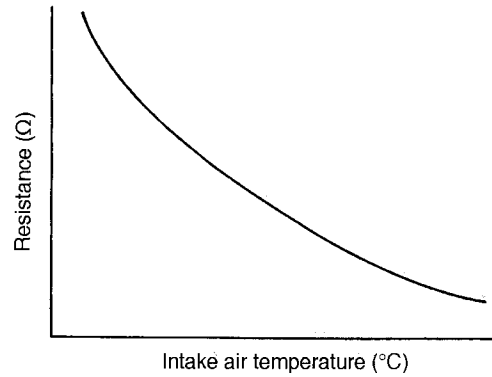
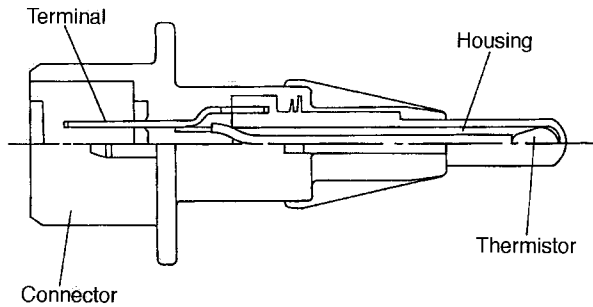

B2H1428

## G: INDUCTION CONTROL SYSTEM

There is a butterfly valve on the partition between the intake manifold's right bank and left bank chambers. This valve is operated by the induction valve actuator installed on the intake manifold. During operation of the engine, pressure waves are generated in the intake manifold. The pressure waves have an effect of improving air intake efficiency. To make the most of this effect, the direction of the pressure wave is changed by opening and closing the induction valve in accordance with the engine speed so that increased engine output torque is obtained in all speed ranges.

### Mid-speed range

From air cleaner

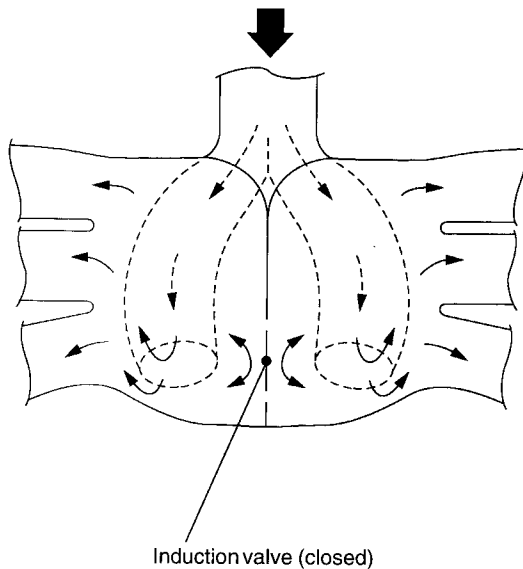

### Low and high speed ranges

From air cleaner

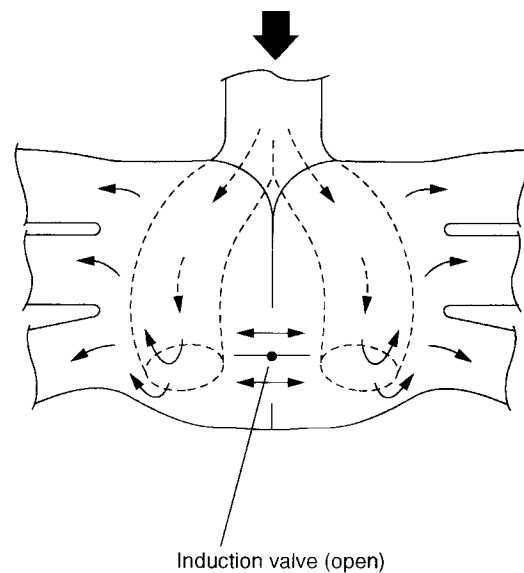

B2H3908A