

12. Cooling System SA07688

A: INSPECTION SA07688A10

1) Check radiator for leakage, filling it with coolant and attach radiator cap tester (A) to the filler neck. Then apply a pressure of 157 kPa (1.6 kg/cm², 23 psi) and check the following points:

- Each portion of radiator for leakage
- Hose joints and other connections for leakage

NOTE:

● When attaching or detaching tester and when operating tester, use special care not to deform radiator filler neck.

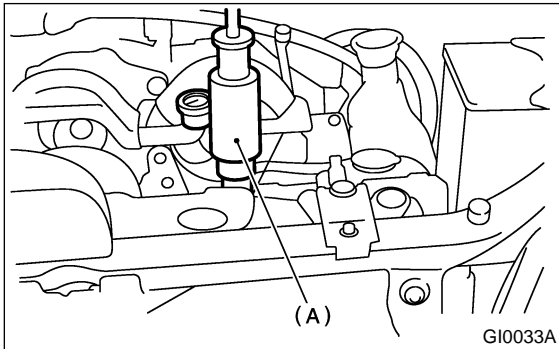

- When performing this check, be sure to keep the engine stationary and fill radiator with coolant.
- Wipe off check points before applying pressure.
- Use care not to spill coolant when detaching tester from radiator.

2) Check the radiator cap valve open pressure using radiator cap tester.

NOTE:

Rust or dirt on cap may prevent valve from functioning normally: be sure to clean cap before testing.

Raise the pressure until the needle of gauge stops and see if the pressure can be retained for five to six seconds. The radiator cap is normal if a pressure above the service limit value has been maintained for this period.

Radiator cap valve open pressure

Standard value:

93 — 123 kPa (0.95 — 1.25 kg/cm², 14 — 18 psi)

Service limit:

83 kPa (0.85 kg/cm², 12 psi)

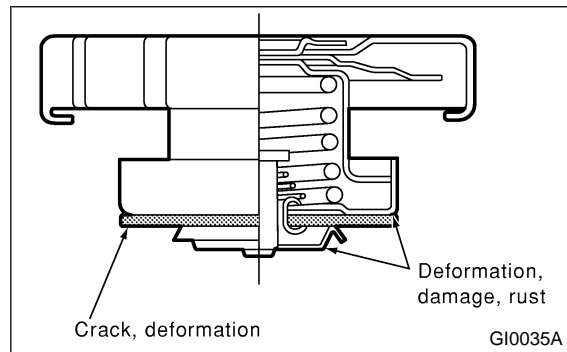
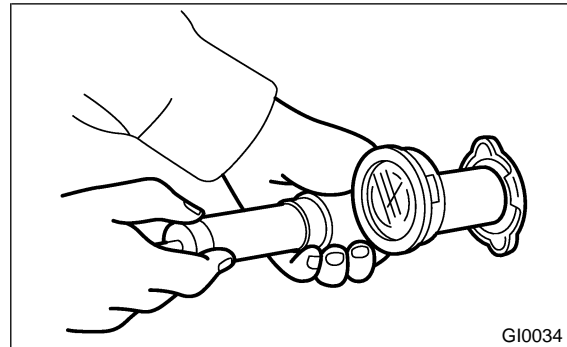

3) If the coolant temperature exceeds 76.0 to 80.0°C (169 to 176°F) while radiator is not so hot, check thermostat. If thermostat does not open at 76.0 to 80.0°C (169 to 176°F), replace it with a new one.

4) If electric fan does not operate when coolant temperature exceeds 90 to 94°C (194 to 201°F), check thermostwitch or fan motor.