

## 8. Anti-lock Brake System S903484

### A: SCHEMATIC S903484A21

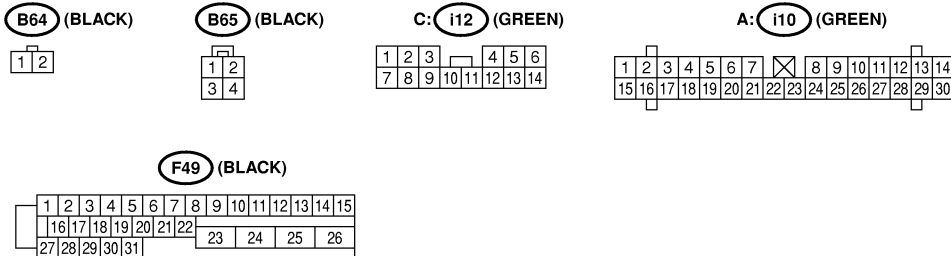
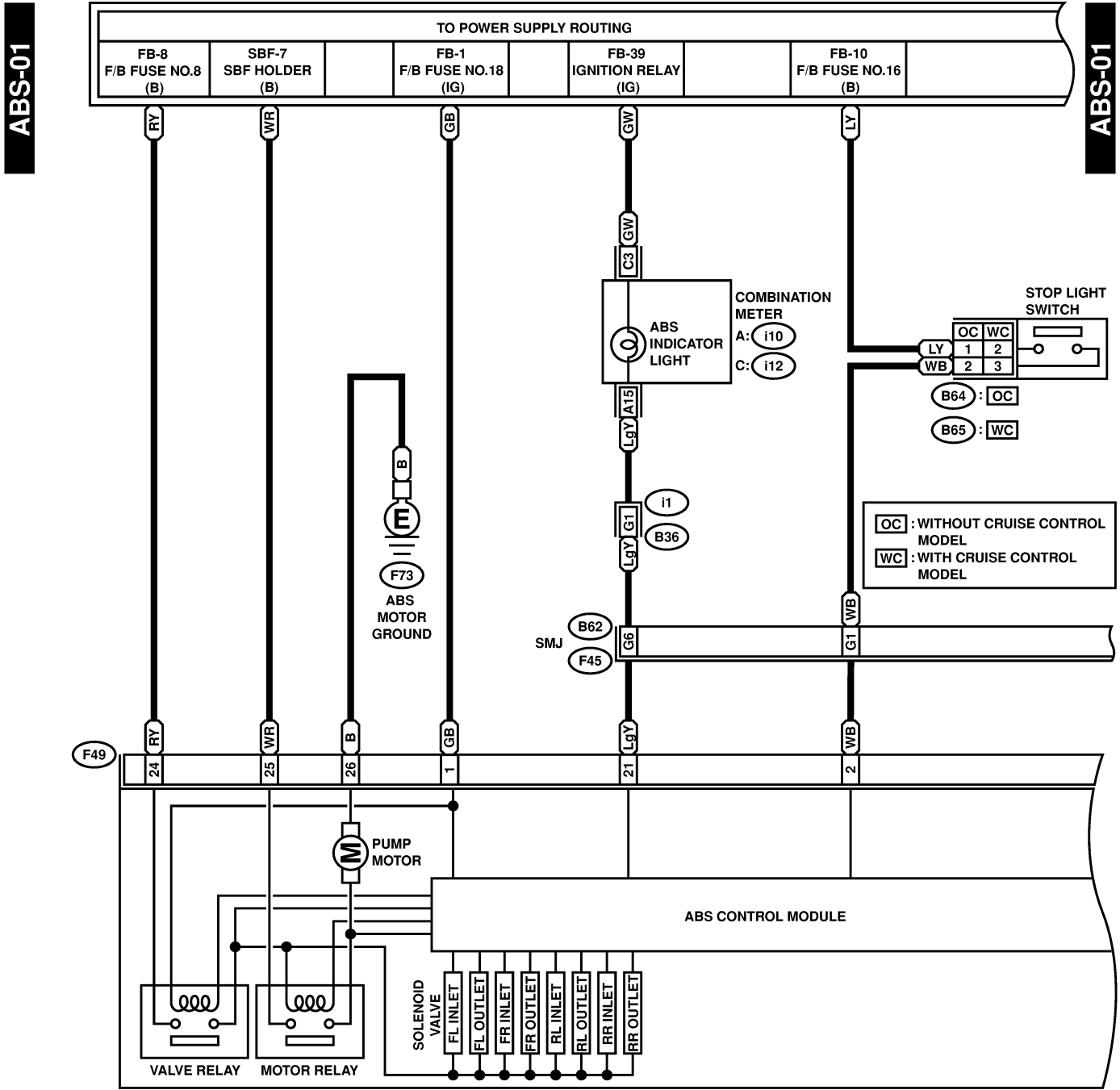

# ANTI-LOCK BRAKE SYSTEM

Wiring System

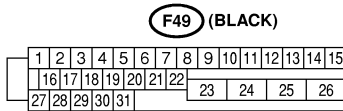
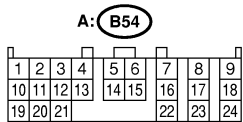
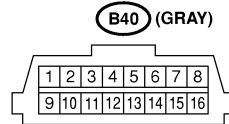
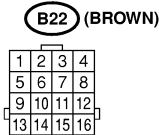
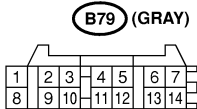
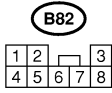
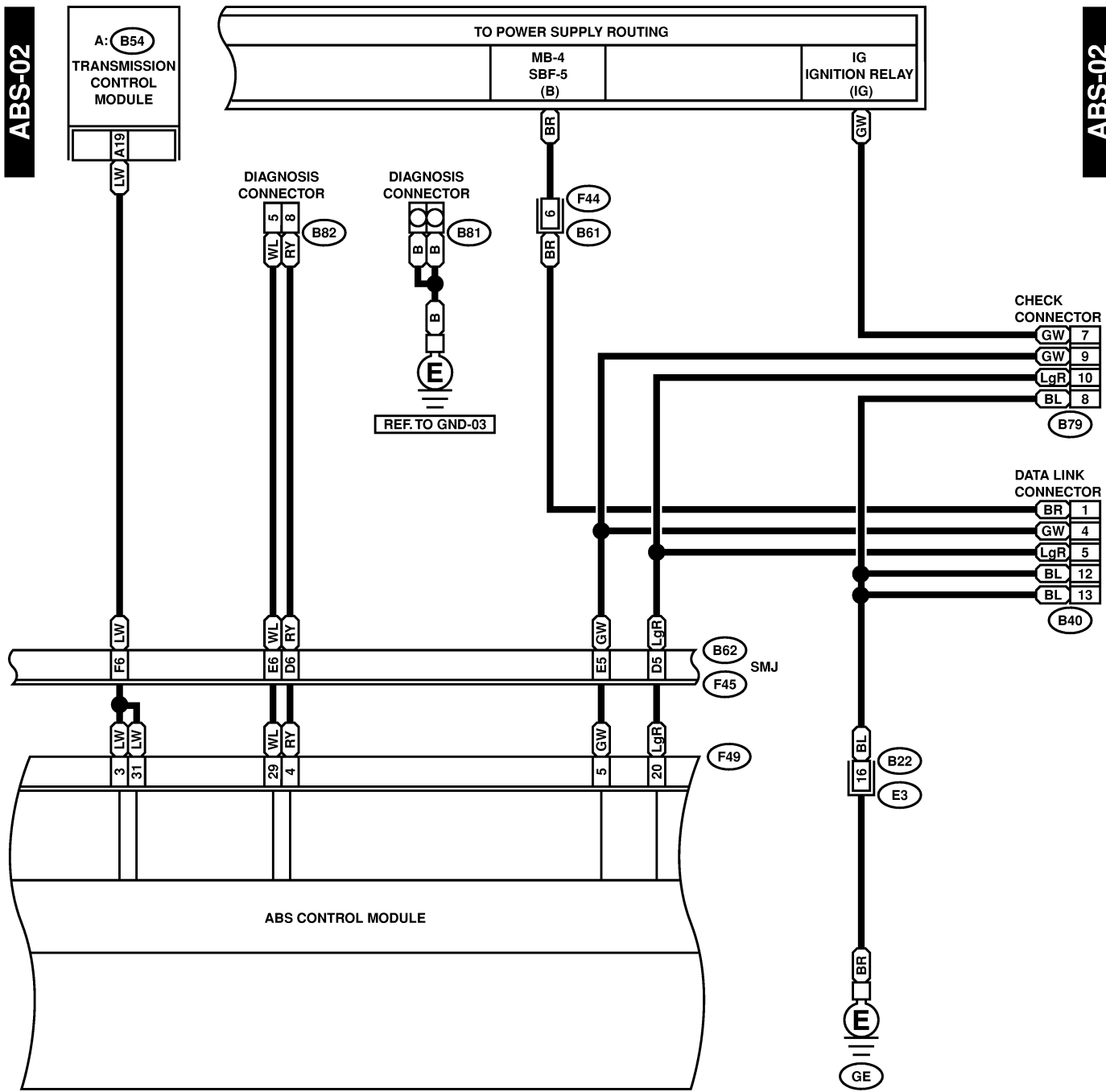

# ANTI-LOCK BRAKE SYSTEM

Wiring System

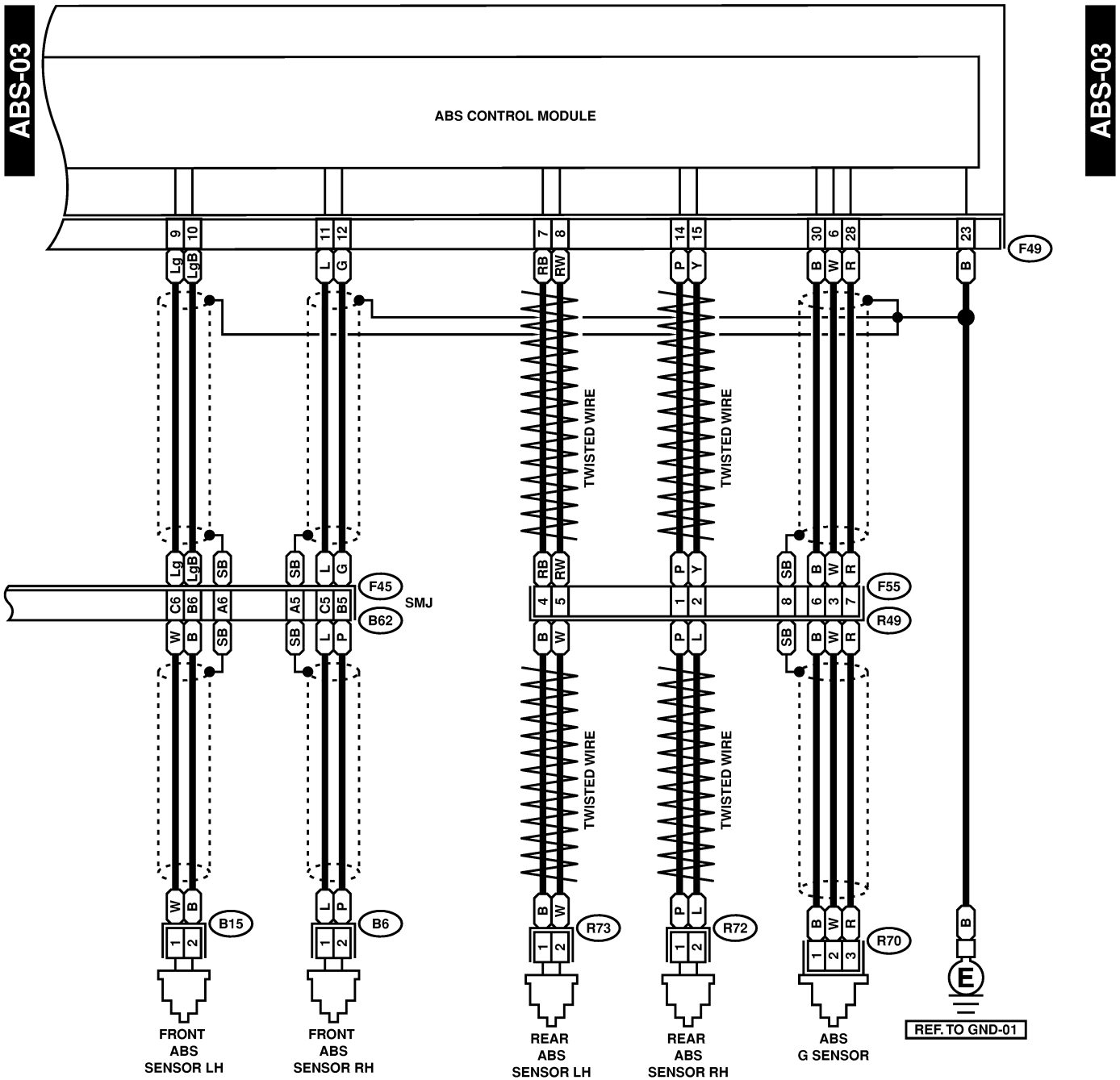

B6 : \*1 R72 (GRAY)

R70 (BLACK)

F55

F49 (BLACK)

B15 : \*1 R73 (GRAY)

1 2 3

1	2	3
4	5	6 7 8

1	2	3	4	5	6	7	8	9	10	11	12	13	14	15
16	17	18	19	20	21	22	23	24	25	26				
27	28	29	30	31										

2 1

\*1 : OUT BACK: (BROWN)  
OTHER MODELS: (GRAY)