

11. Audio System S903486

A: SCHEMATIC S903486A21

AUDIO SYSTEM

Wiring System

1. EXCEPT MCINTOSH AUDIO MODEL S903486A2103

AUDIO-01

AUDIO-01

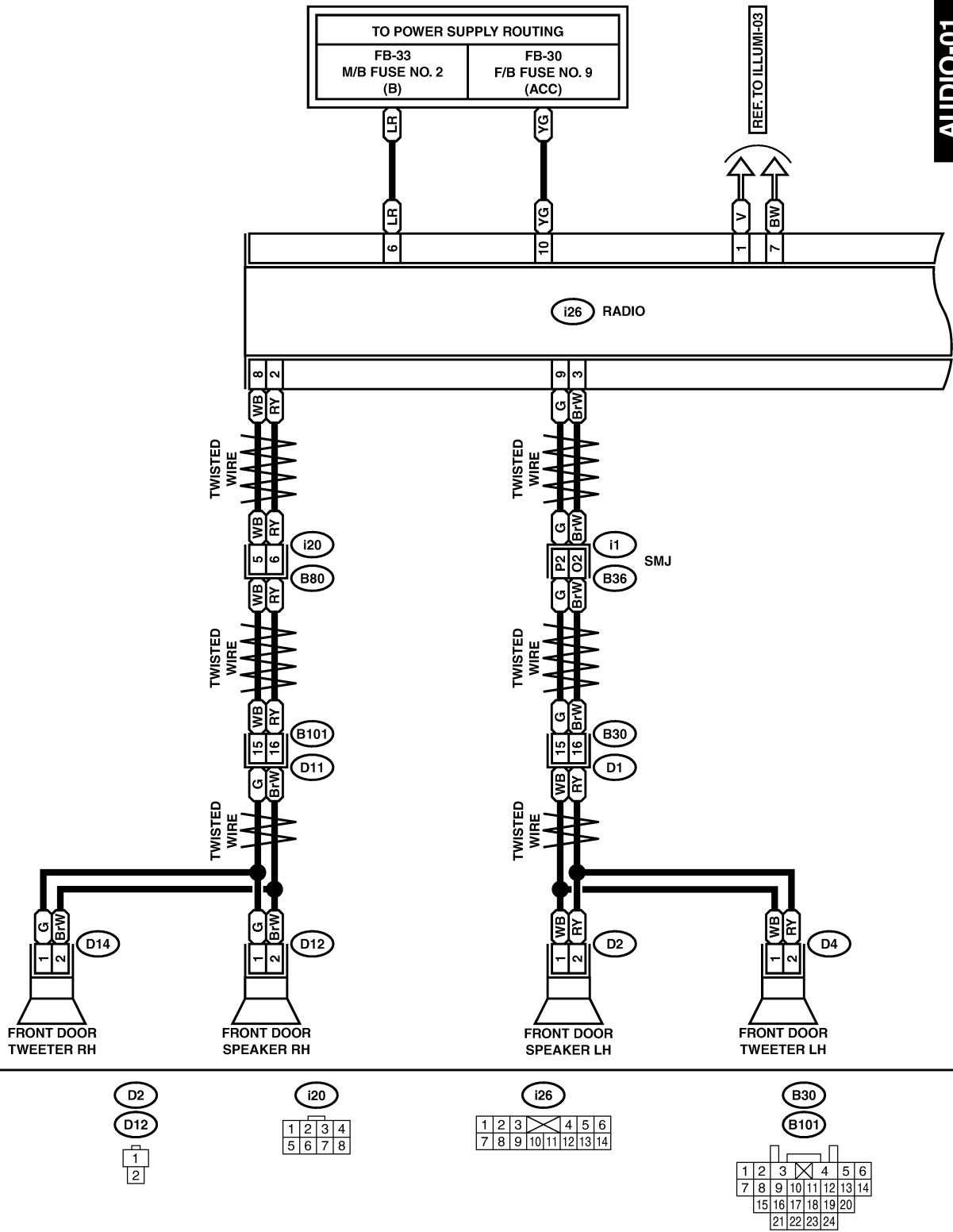

AUDIO SYSTEM

Wiring System

AUDIO-02

AUDIO-02



SPEAKER JOINT CONNECTOR RH (WITH REAR TWEETER MODEL)

SPEAKER JOINT CONNECTOR LH (WITH REAR TWEETER MODEL)

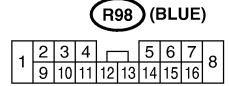
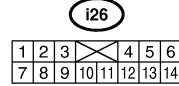
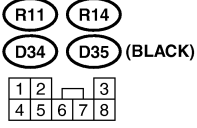
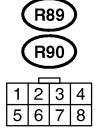
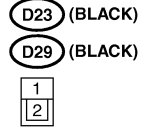
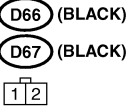
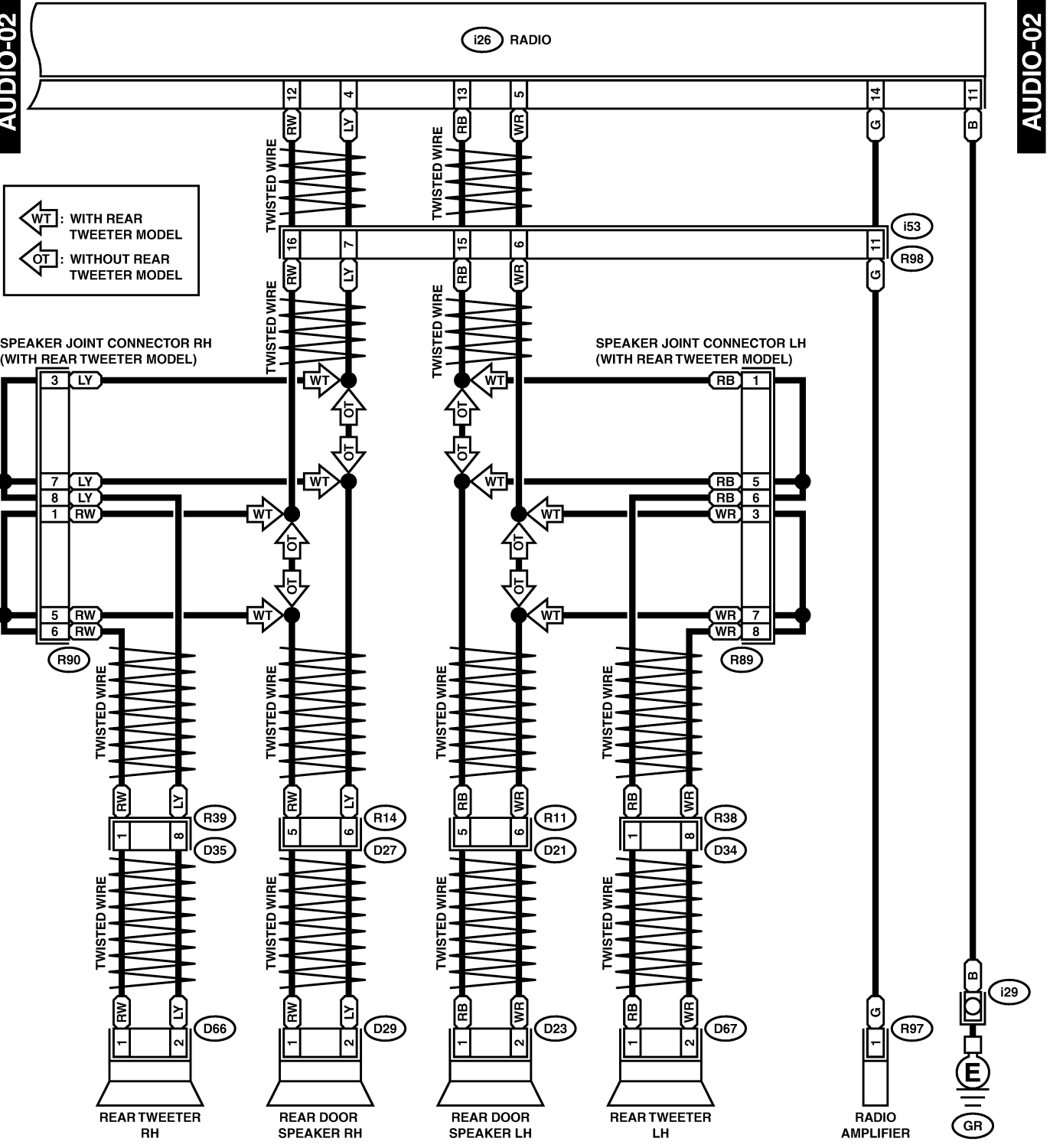

AUDIO SYSTEM

Wiring System

2. MCINTOSH AUDIO MODEL S903486A2104

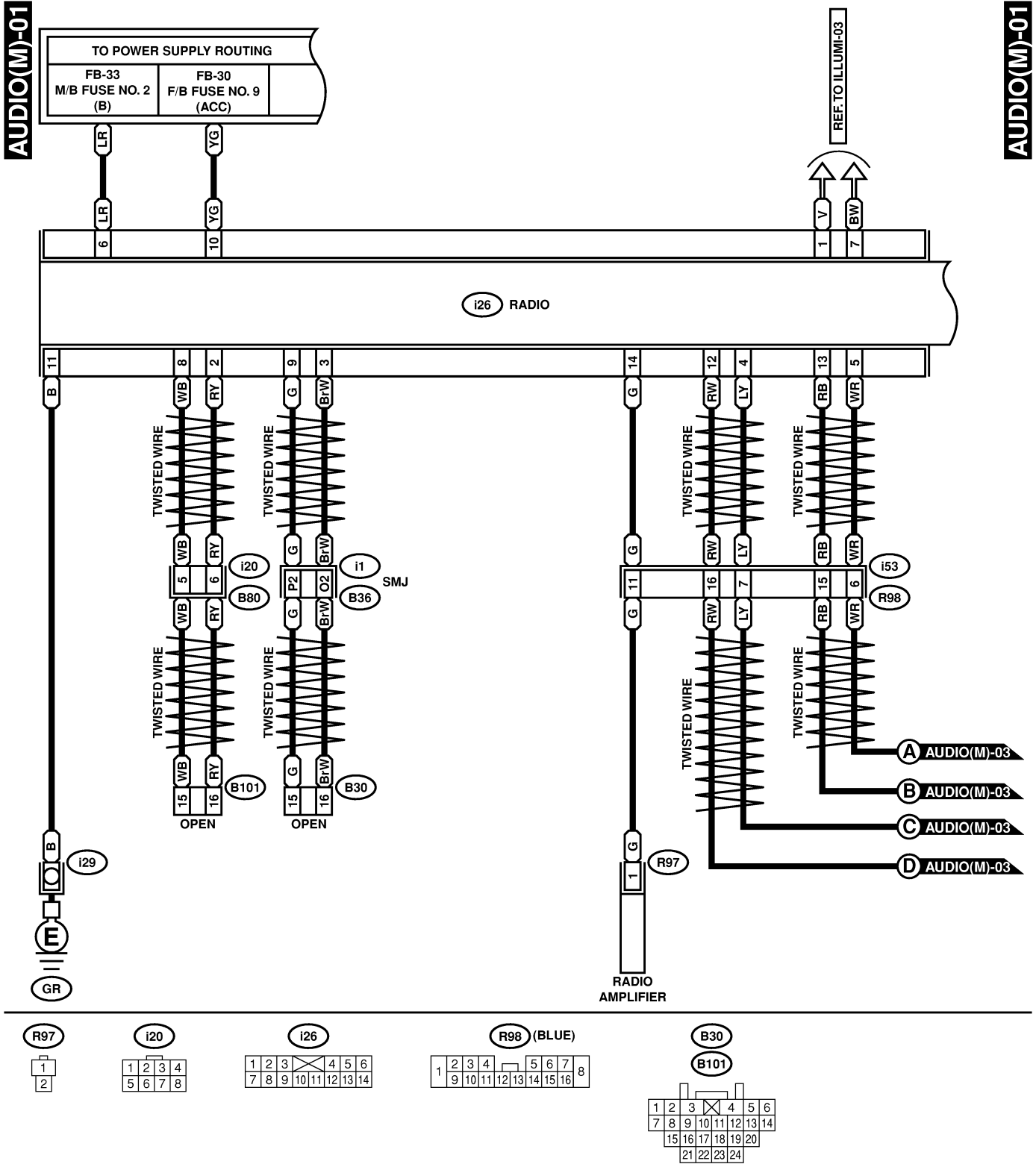

AUDIO SYSTEM

Wiring System

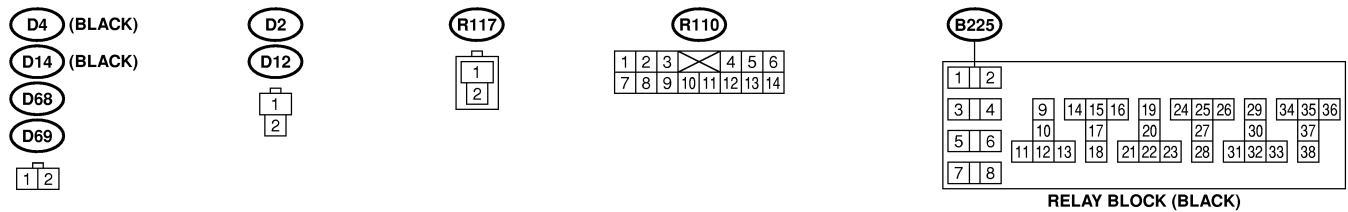
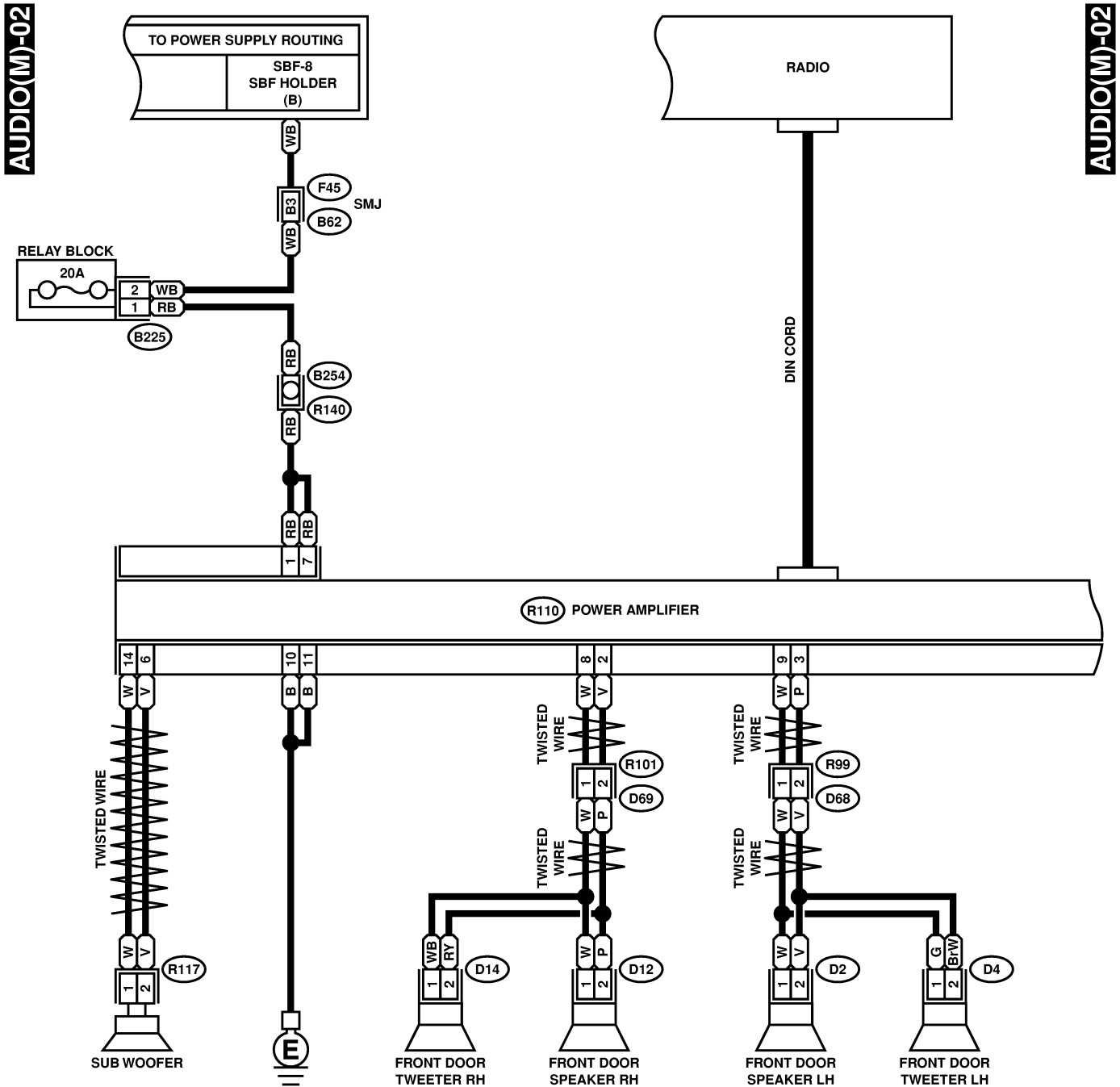

AUDIO SYSTEM

Wiring System

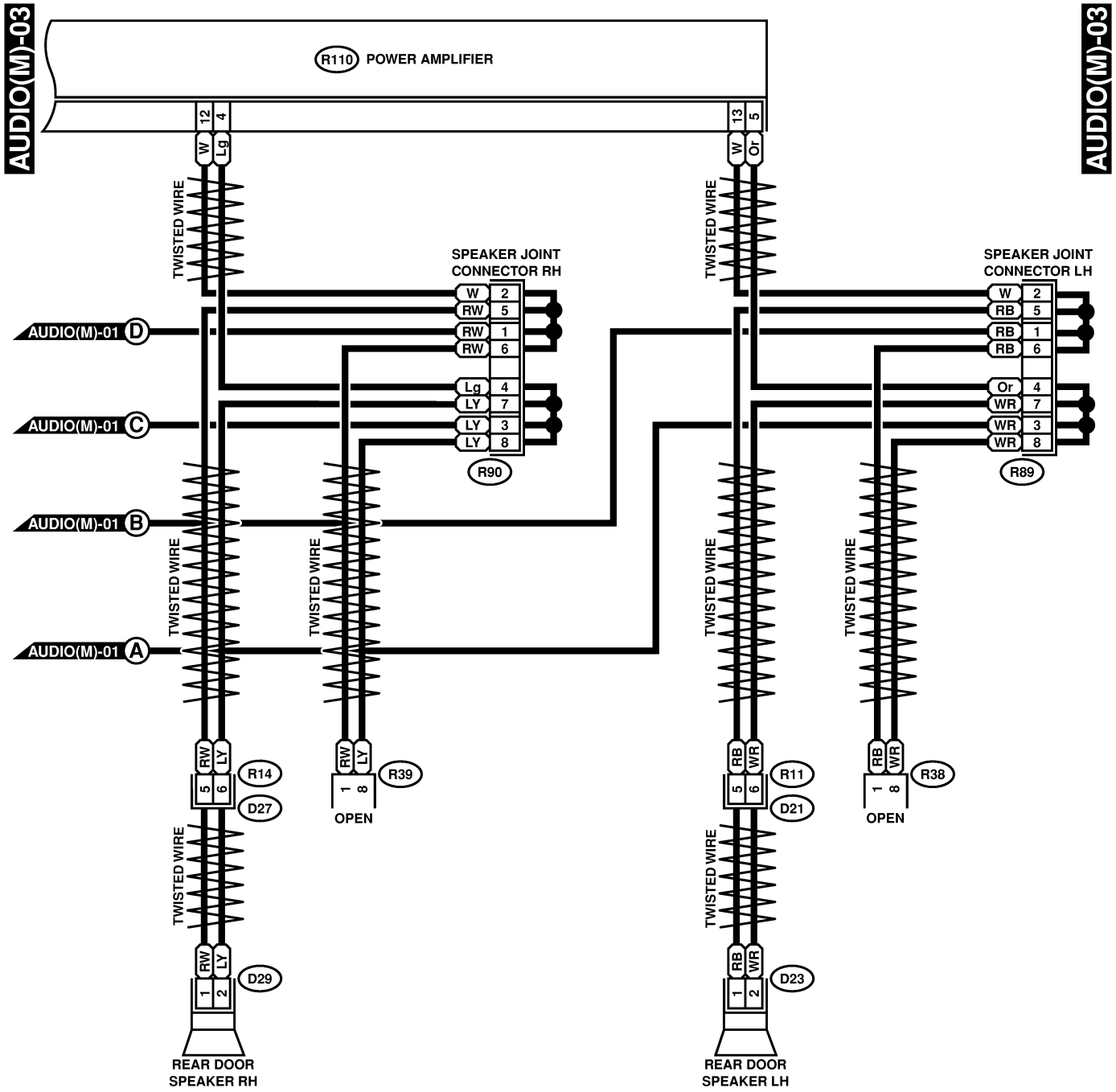

D23 (BLACK)

R89

R11

R38

R110

D29 (BLACK)

R90

R14

R39

