

7. Air Conditioning System S903471

A: SCHEMATIC S903471A21

AIR CONDITIONING SYSTEM

Wiring System

1. MANUAL A/C MODEL S903471A2.105

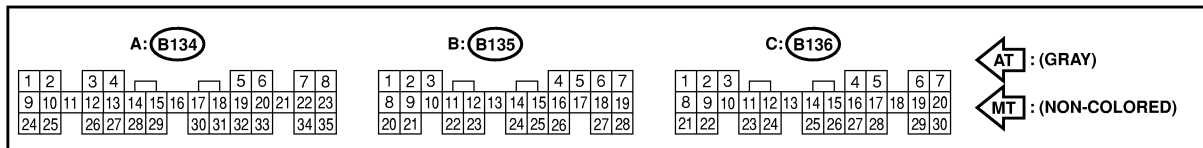
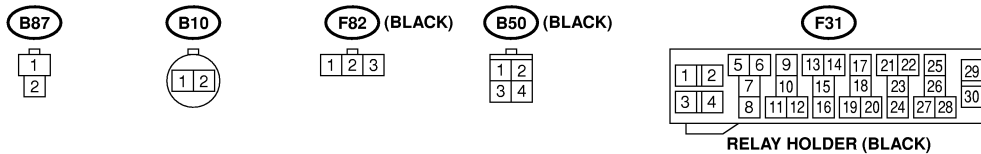
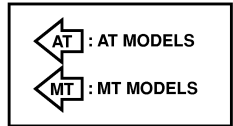
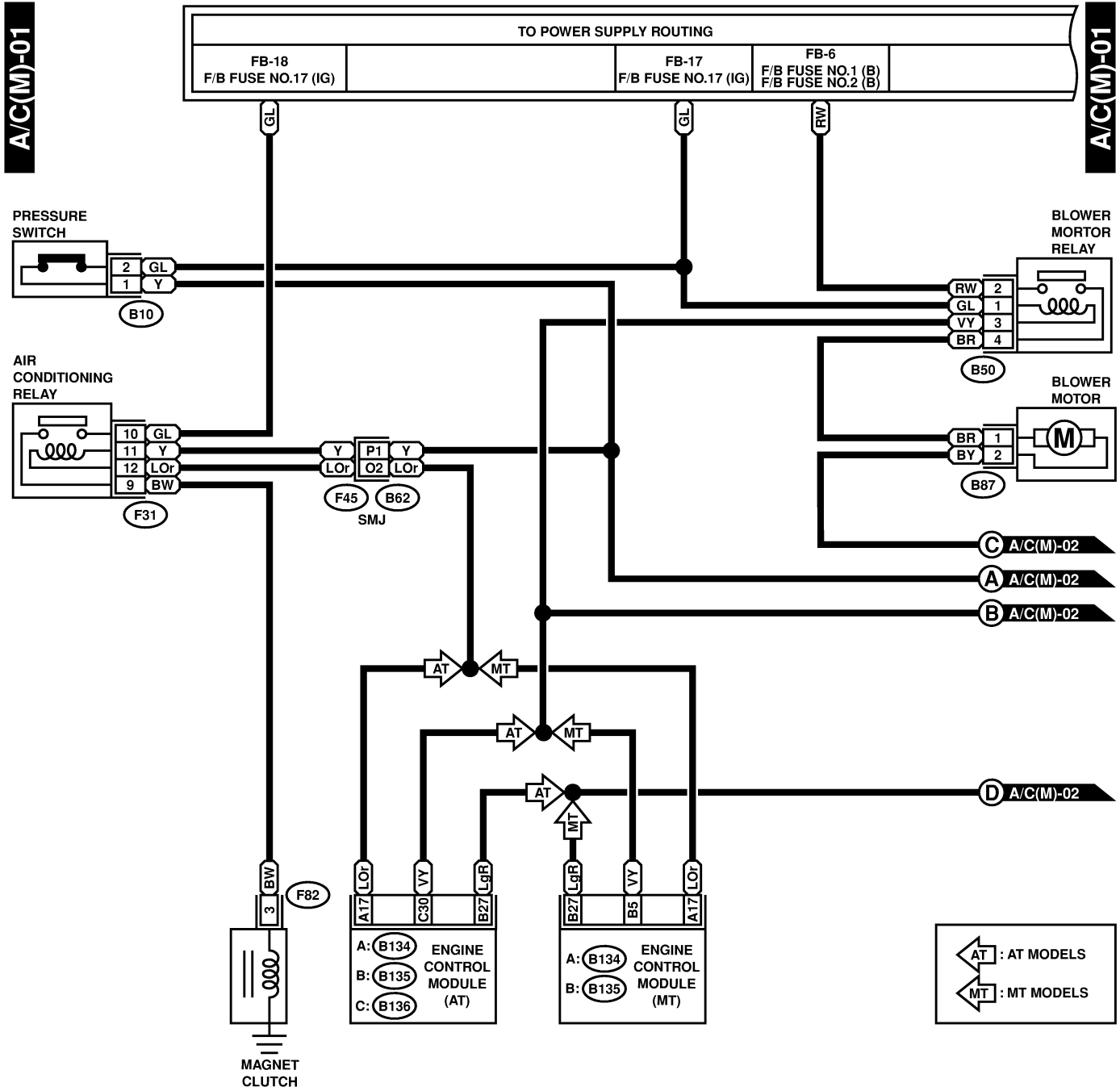

BU45-21A

AIR CONDITIONING SYSTEM

Wiring System

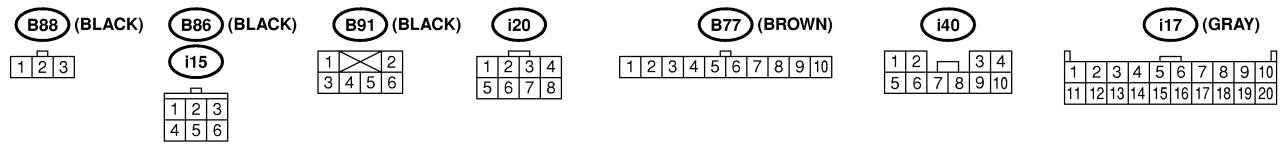
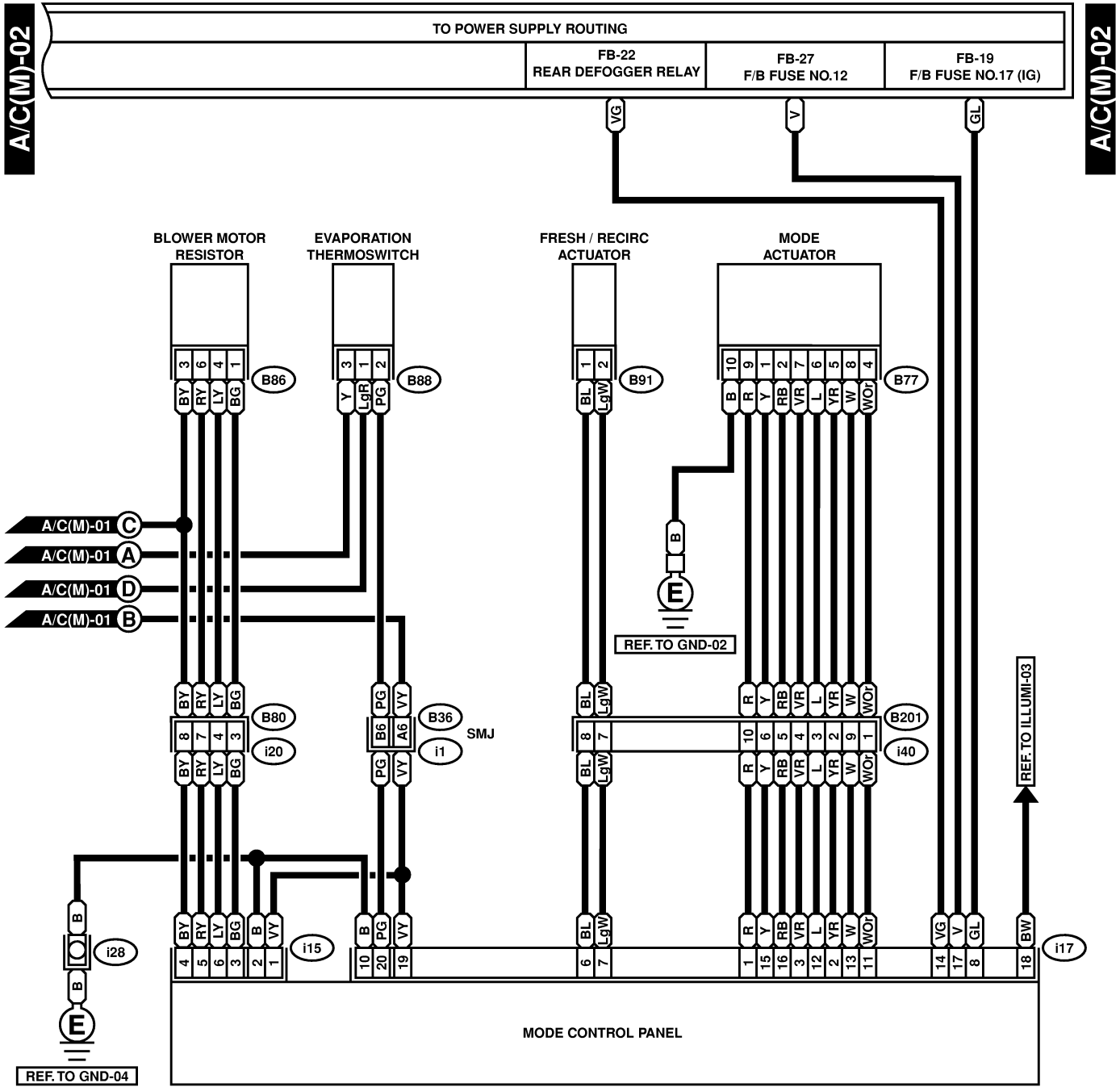

AIR CONDITIONING SYSTEM

Wiring System

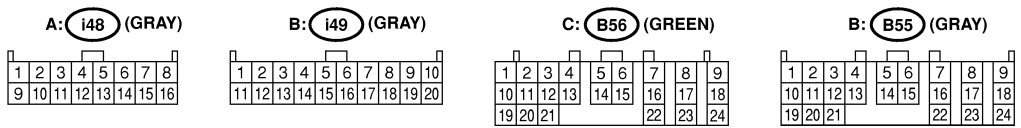
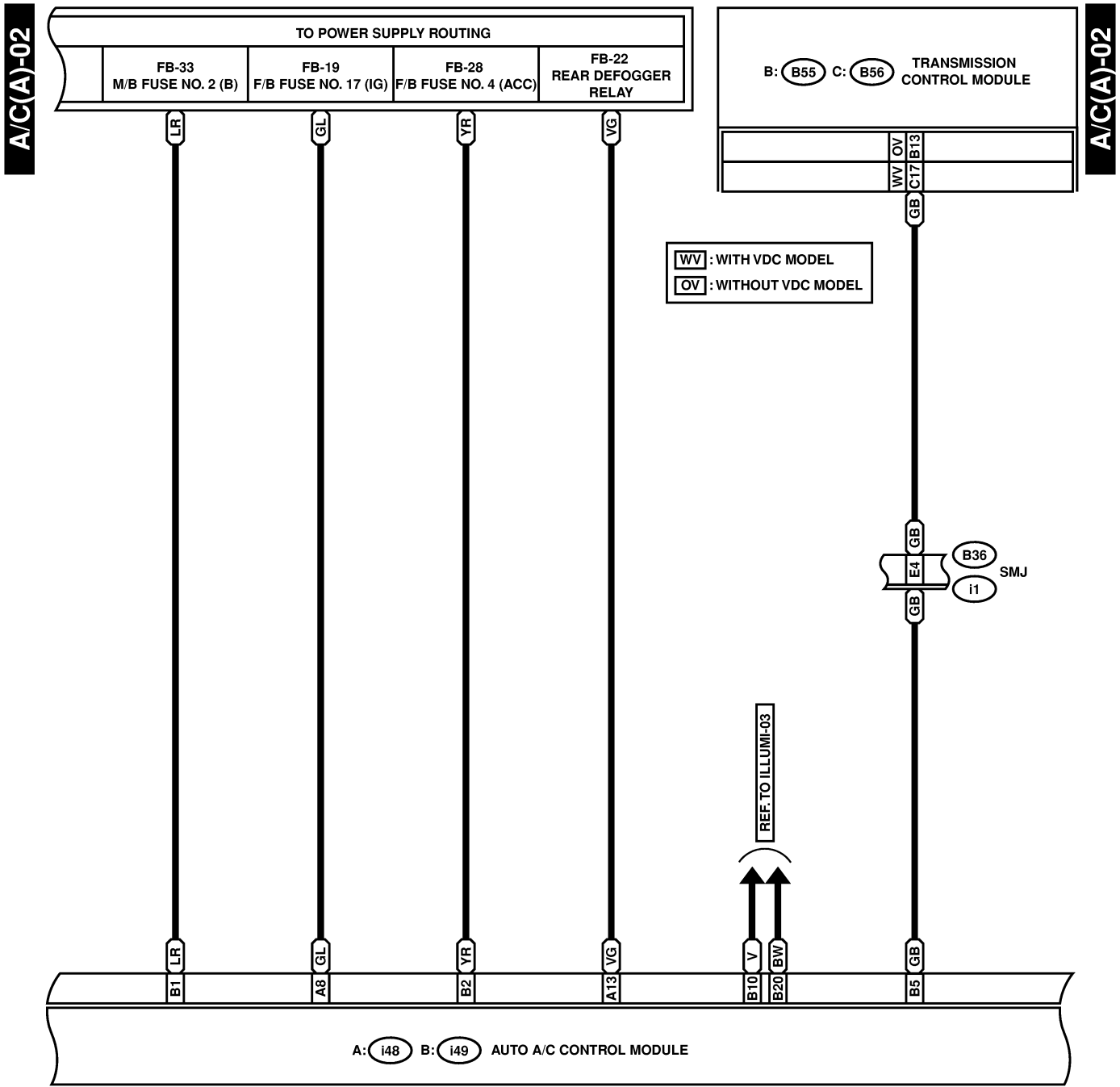

AIR CONDITIONING SYSTEM

Wiring System

