

8. Anti-lock Brake System S903484

A: SCHEMATIC S903484A21

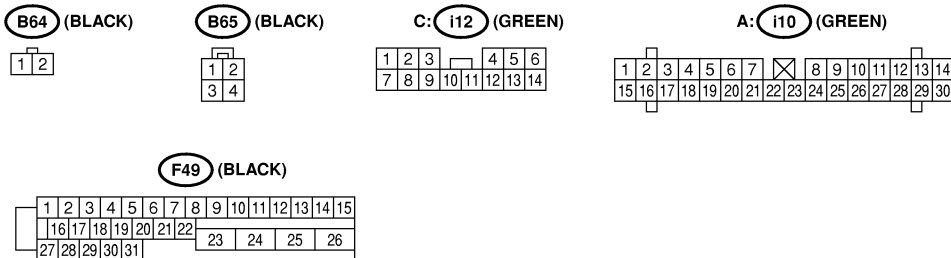
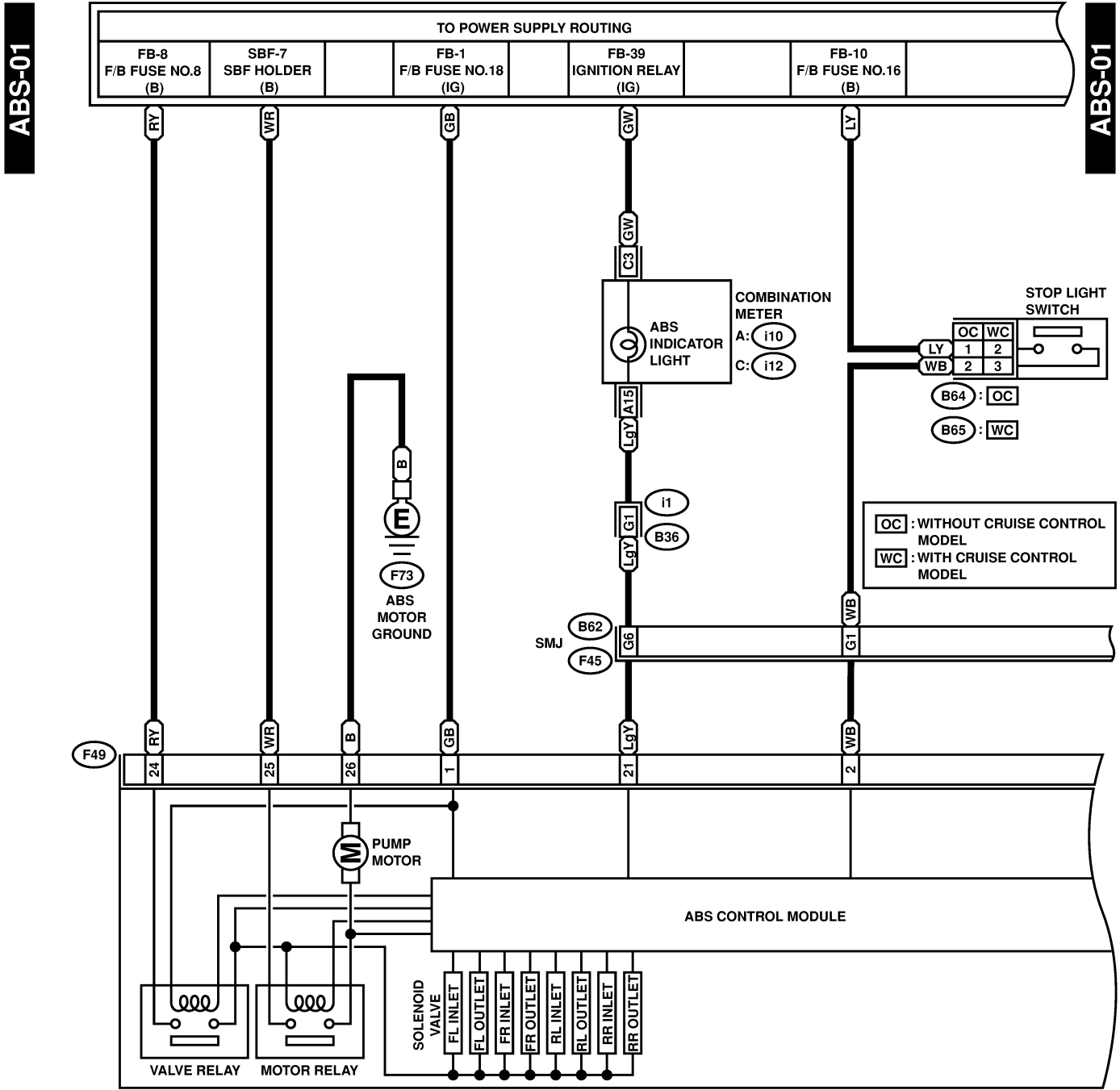

ANTI-LOCK BRAKE SYSTEM

Wiring System

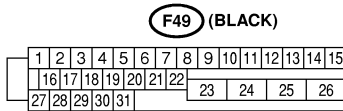
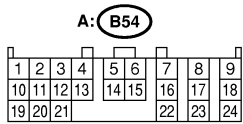
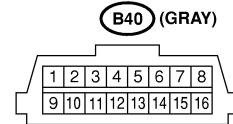
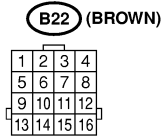
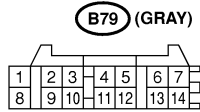
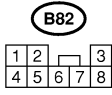
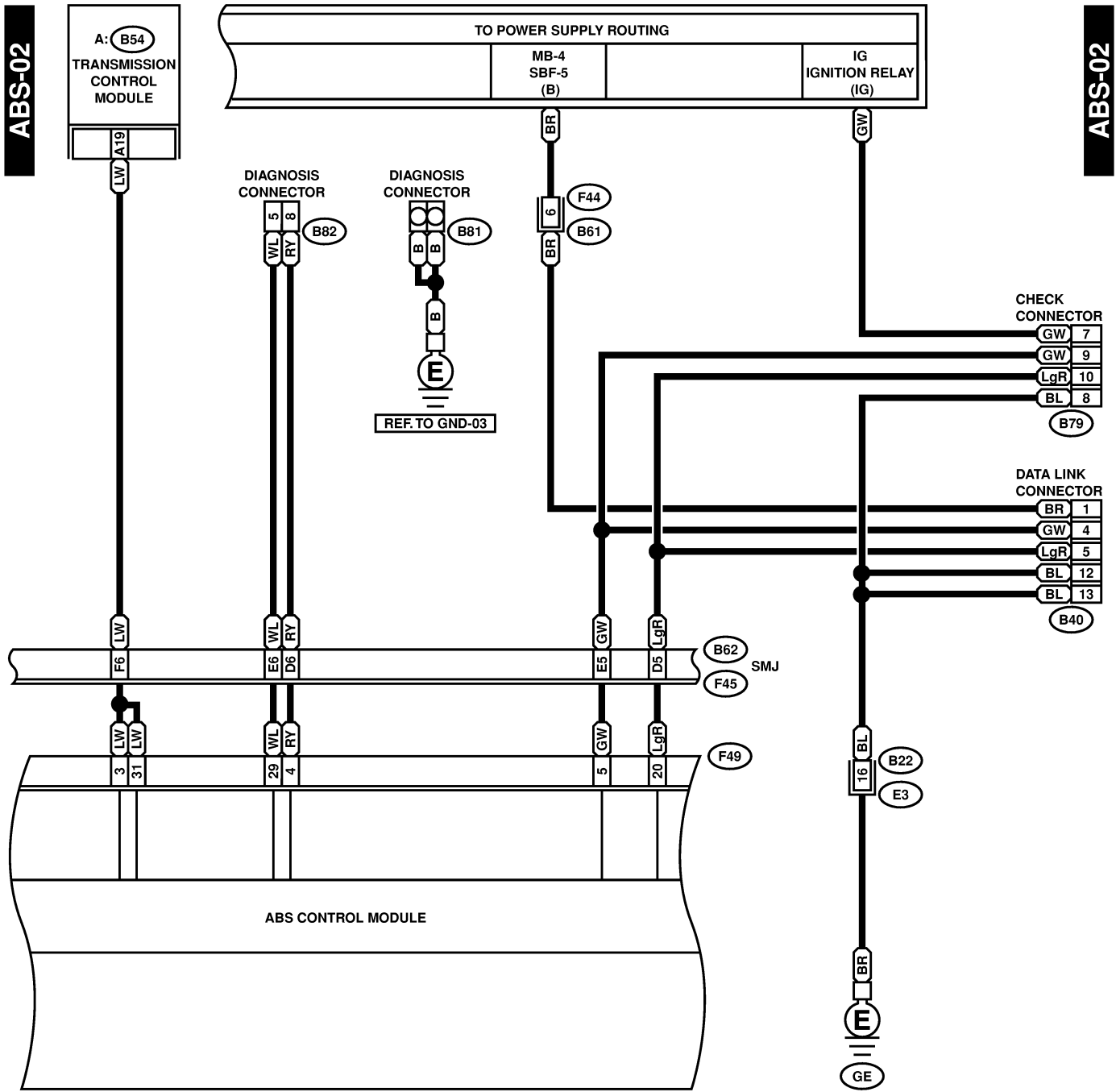

ANTI-LOCK BRAKE SYSTEM

Wiring System

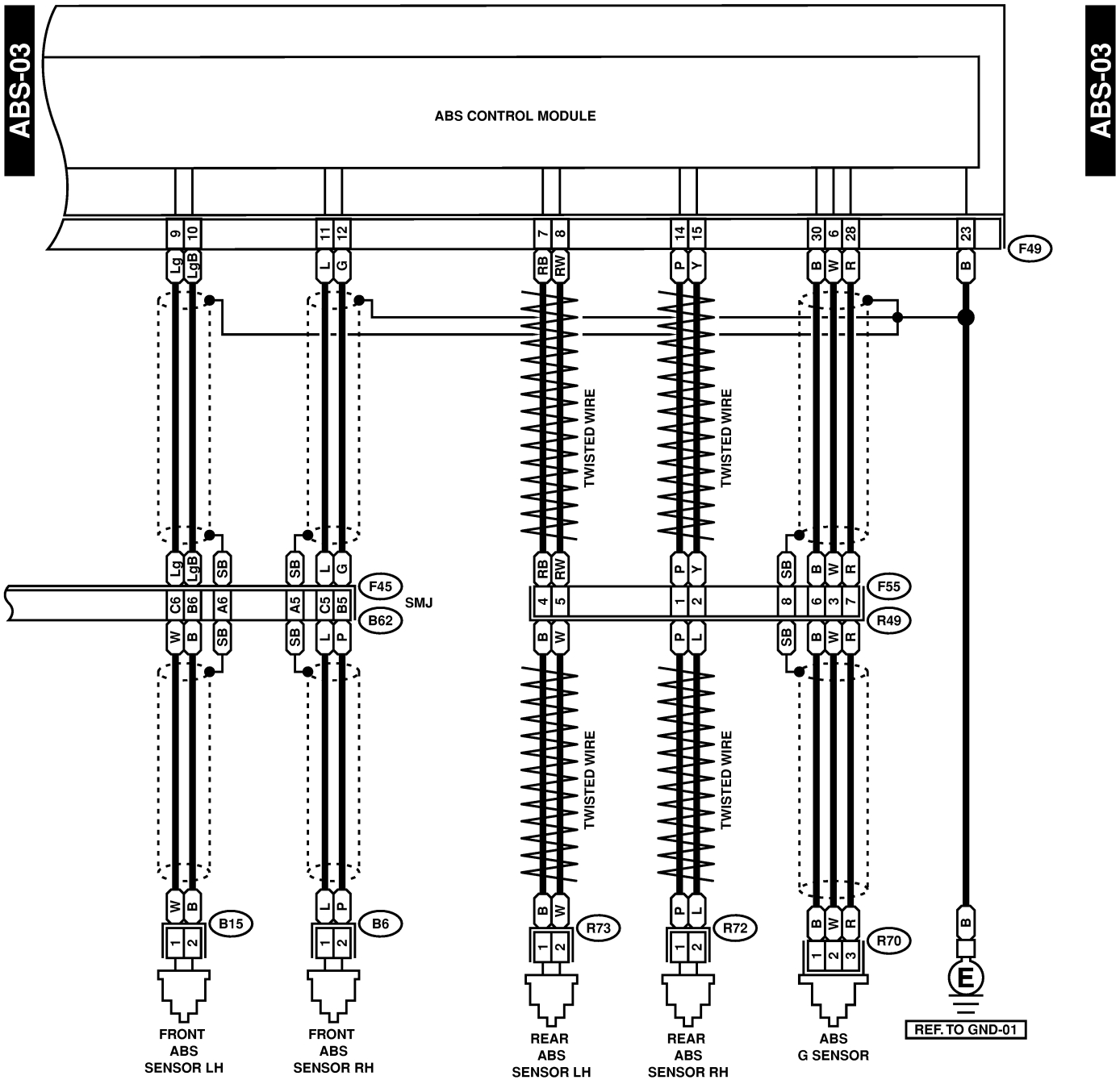

- B6 : *1 R72 (GRAY)
- B15 : *1 R73 (GRAY)

- R70 (BLACK)

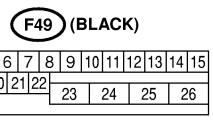
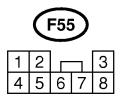

*1 : OUT BACK: (BROWN)
OTHER MODELS: (GRAY)