

ENGINE ELECTRICAL SYSTEM

Wiring System

17. Engine Electrical System S903482

A: SCHEMATIC S903482A21

1. 4-CYLINDER ENGINE MT MODEL S903482A2103

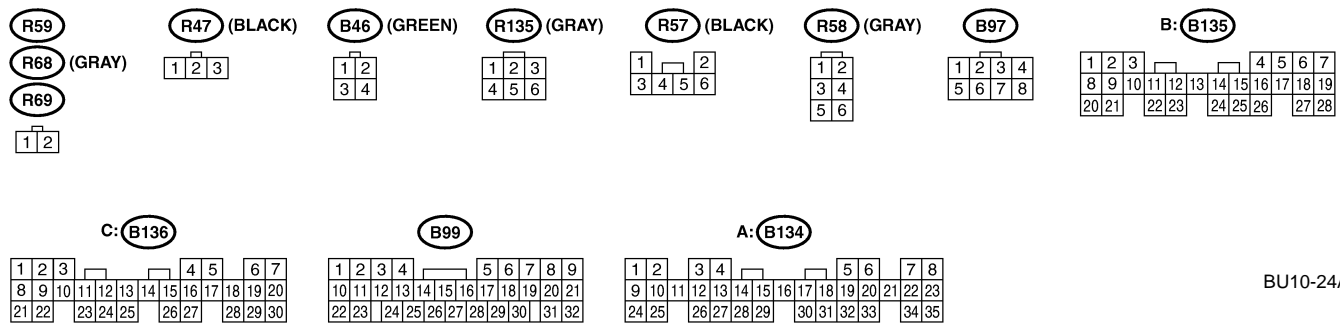
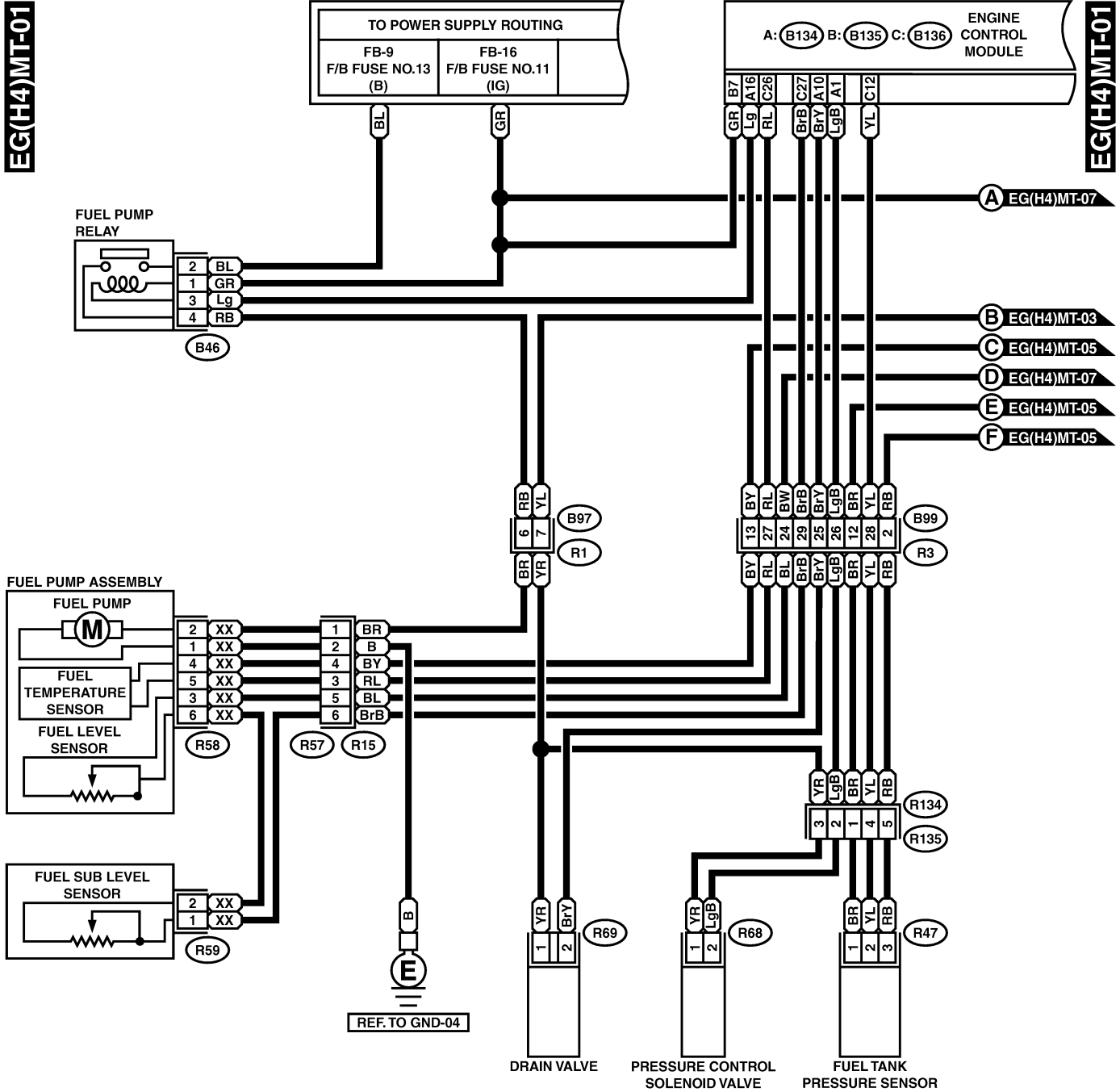

BU10-24A

ENGINE ELECTRICAL SYSTEM

Wiring System

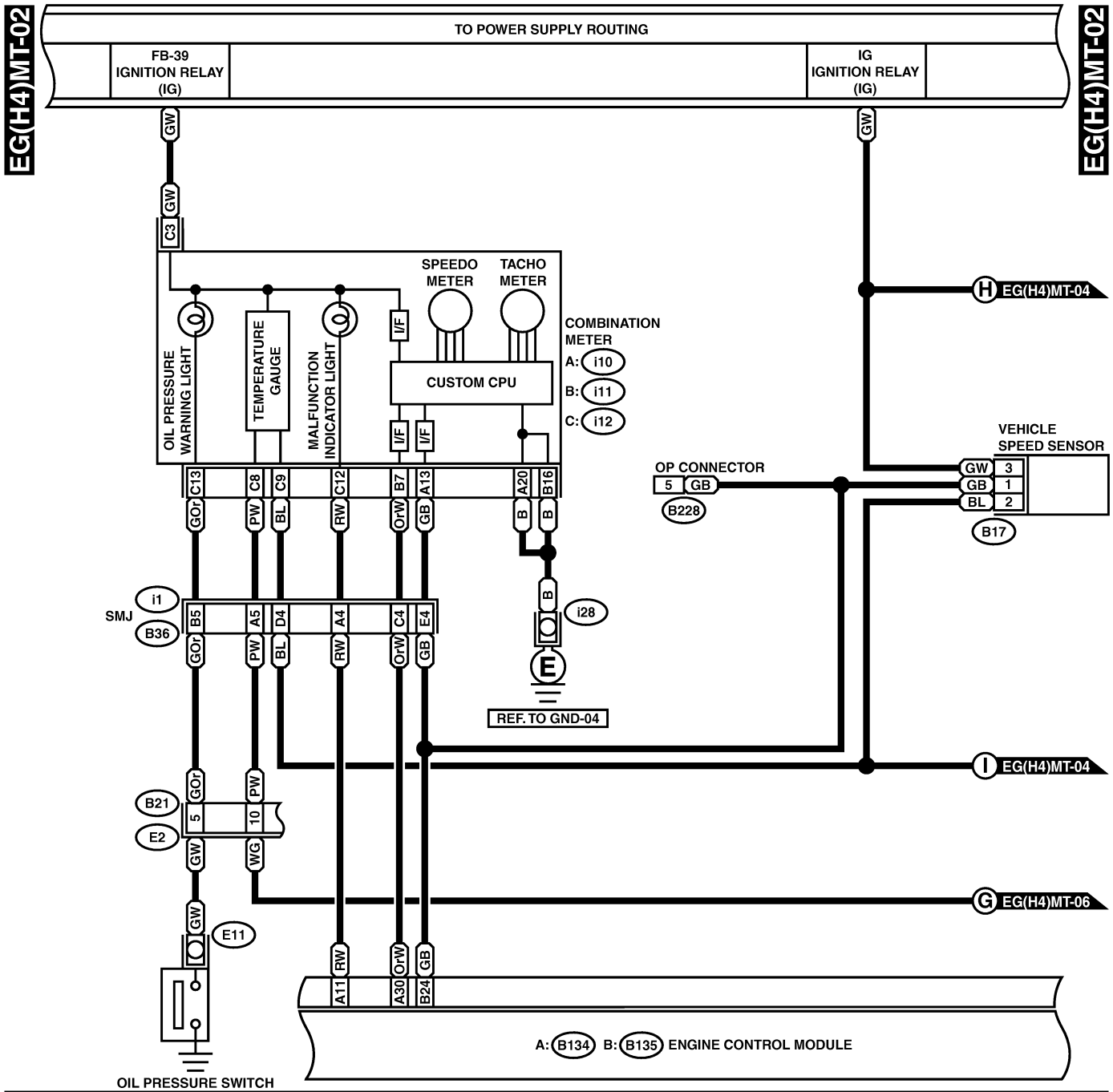

B17 (BLACK)

1	2	3
---	---	---

C: **i12** (GREEN)

1	2	3	4	5	6		
7	8	9	10	11	12	13	14

B228

1	2	3			
4	5	6	7	8	9
10	11	12	13	14	15

B: **i11** (GREEN)

1	2	3	4	5	6	7		
8	9	10	11	12	13	14	15	16

B21 (GRAY)

1	2	3	4
5	6	7	8
9	10	11	12
13	14	15	16
17	18	19	20

B: **B135**

1	2	3	4	5	6	7					
8	9	10	11	12	13	14	15	16	17	18	19
20	21	22	23	24	25	26	27	28			

A: **i10** (GREEN)

1	2	3	4	5	6	7	8	9	10	11	12	13	14		
15	16	17	18	19	20	21	22	23	24	25	26	27	28	29	30

A: **B134**

1	2	3	4	5	6	7	8							
9	10	11	12	13	14	15	16	17	18	19	20	21	22	23
24	25	26	27	28	29	30	31	32	33	34	35			

ENGINE ELECTRICAL SYSTEM

Wiring System

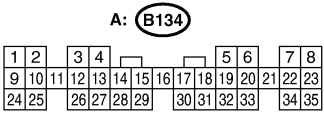
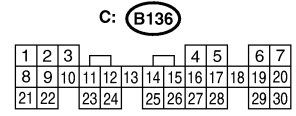
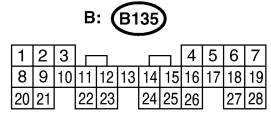
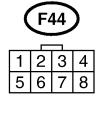
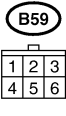
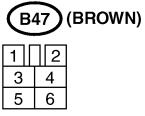
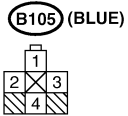
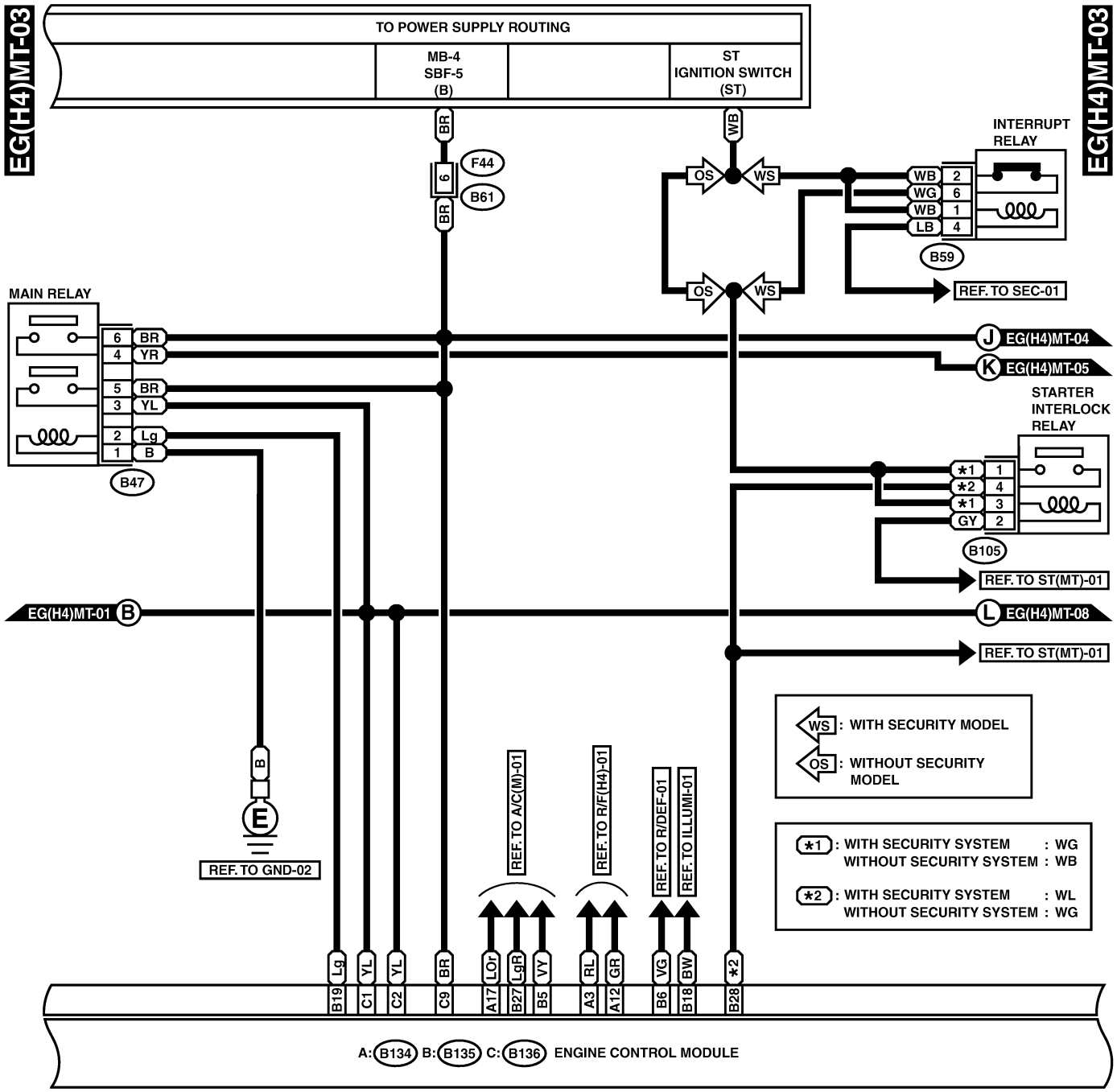

ENGINE ELECTRICAL SYSTEM

Wiring System

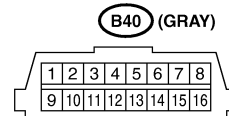
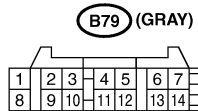
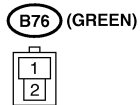
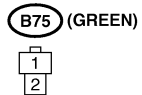
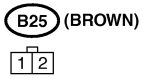
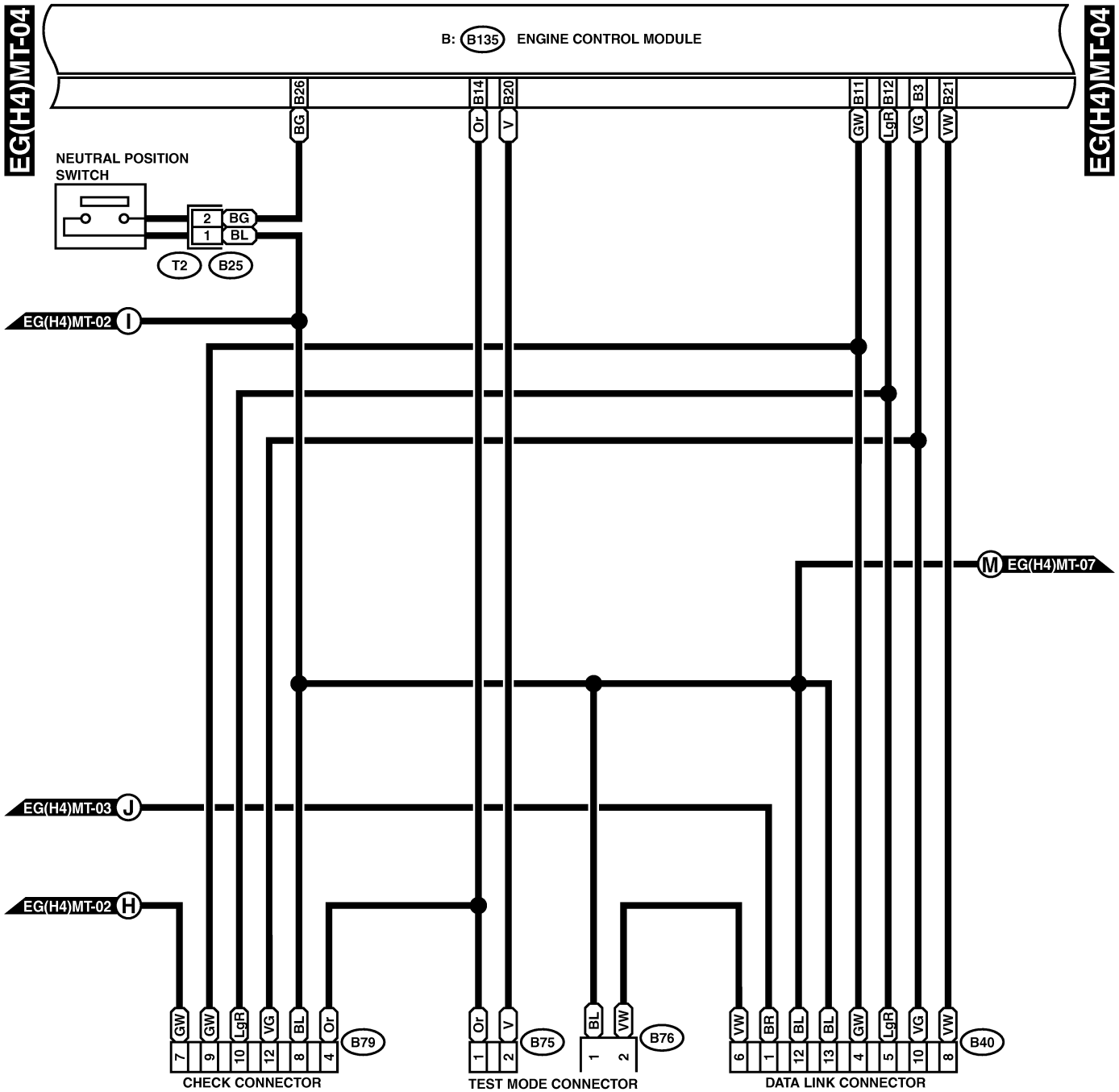

B: B135



ENGINE ELECTRICAL SYSTEM

Wiring System

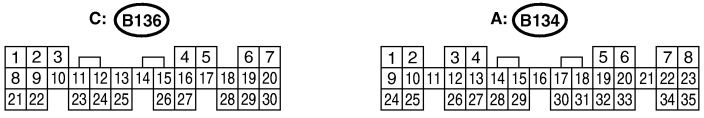
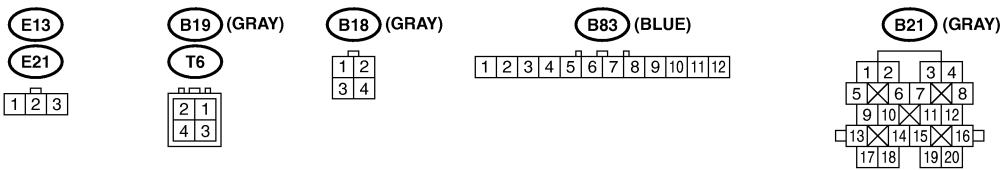
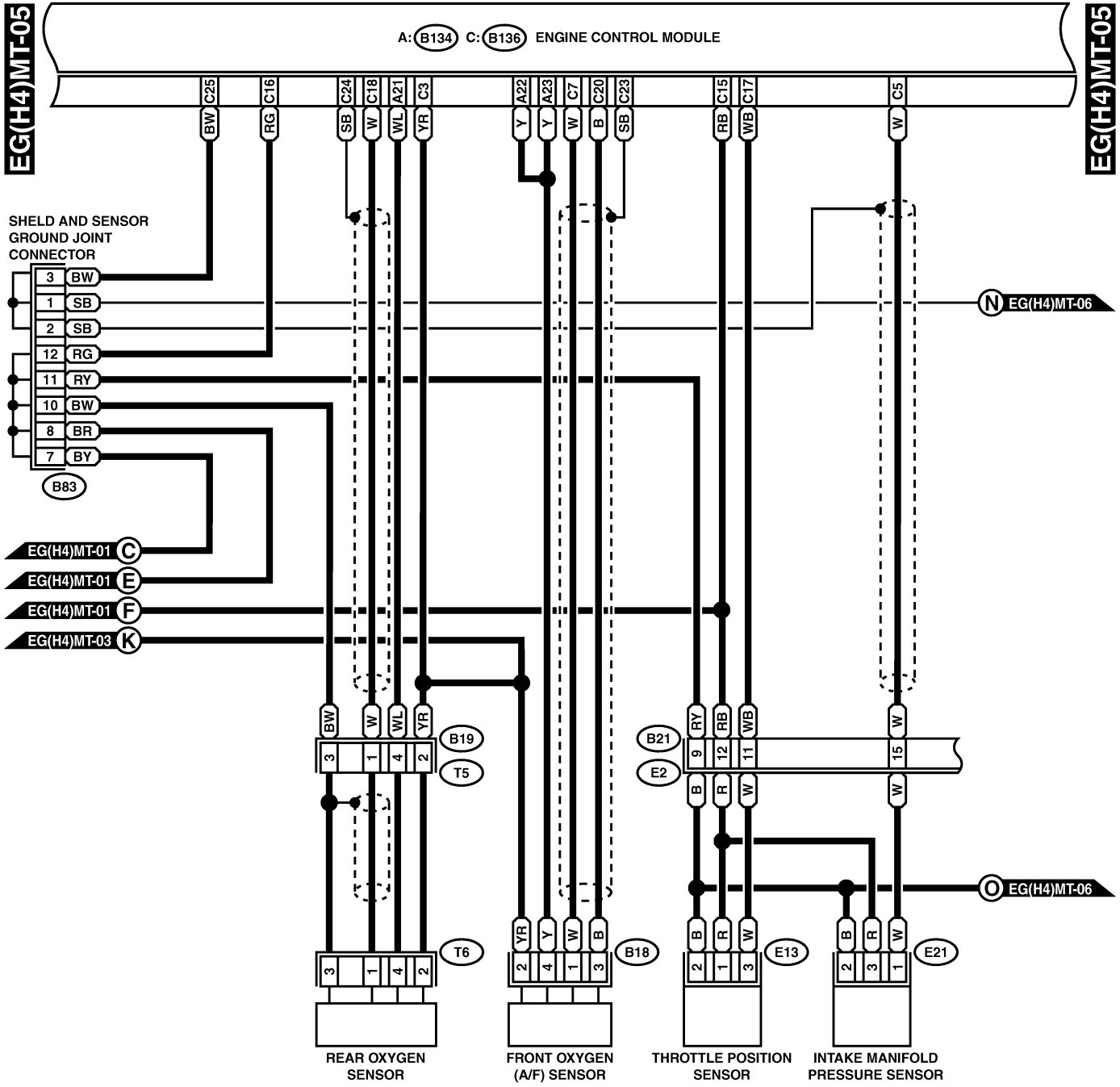

ENGINE ELECTRICAL SYSTEM

Wiring System

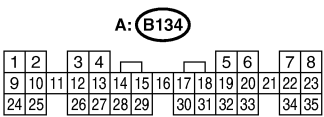
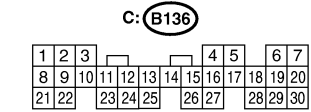
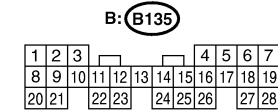
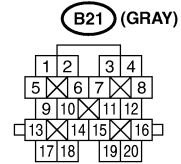
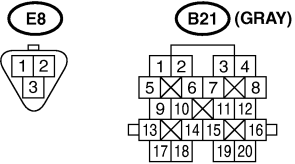
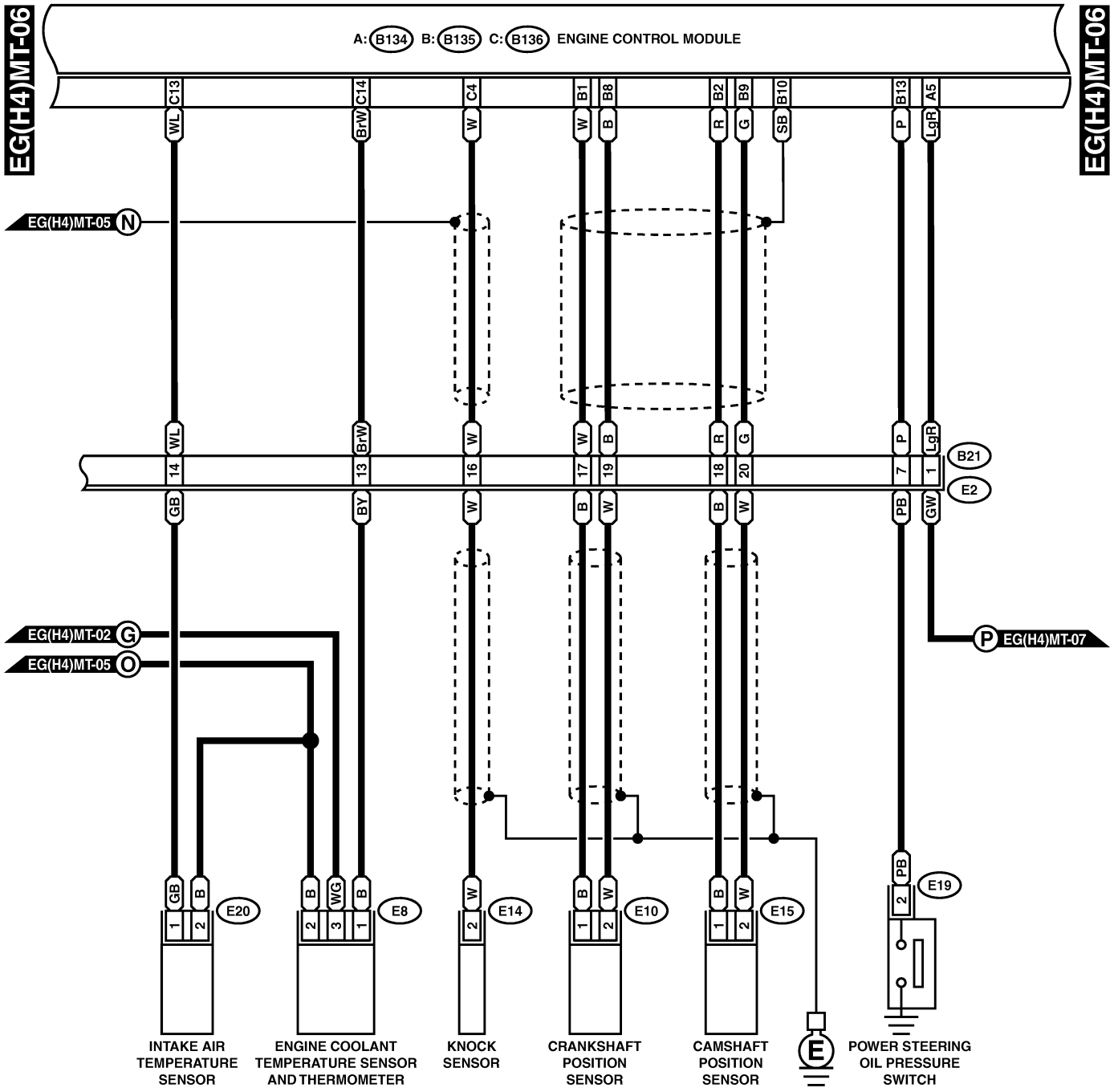

ENGINE ELECTRICAL SYSTEM

Wiring System

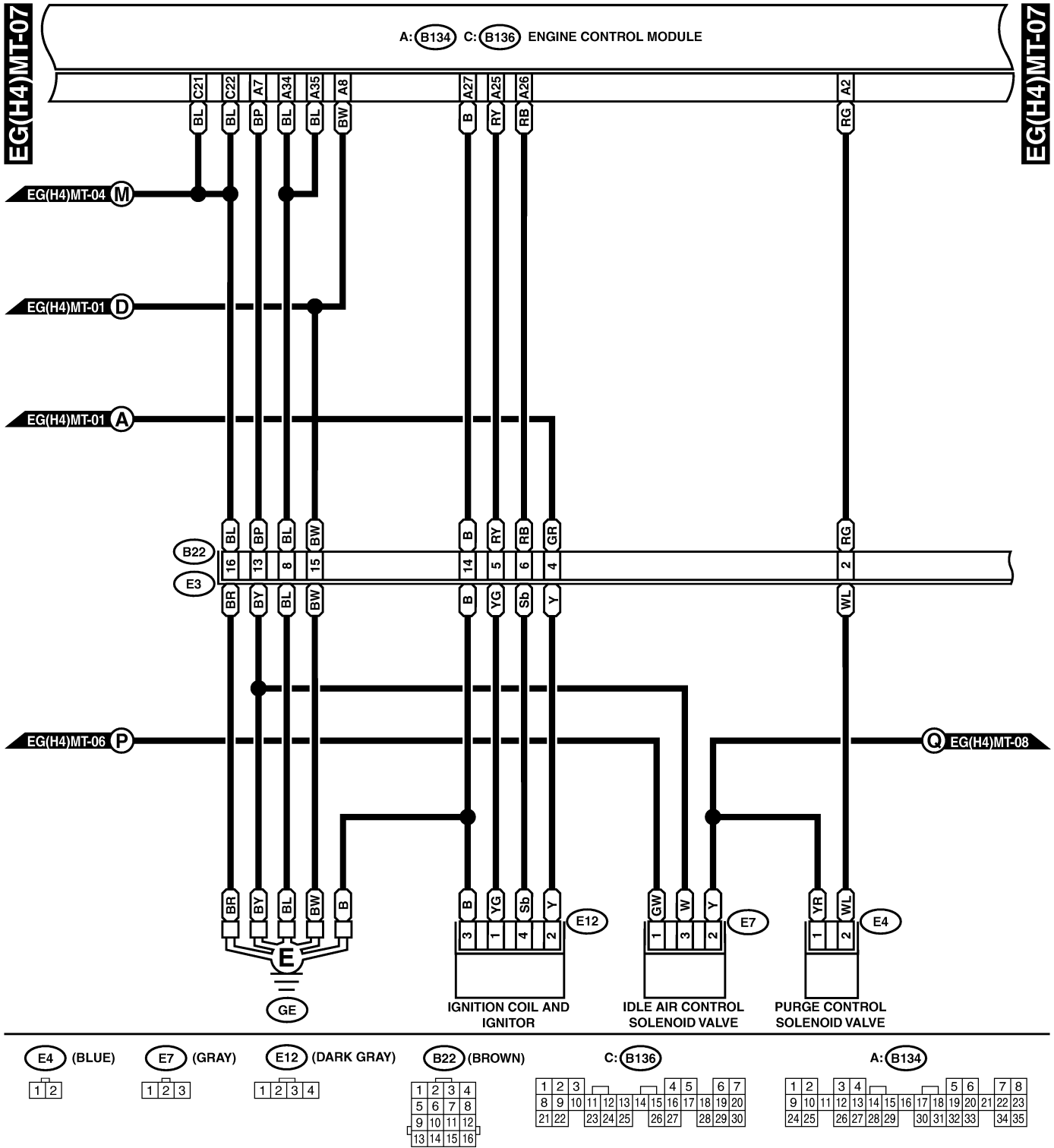

ENGINE ELECTRICAL SYSTEM

Wiring System

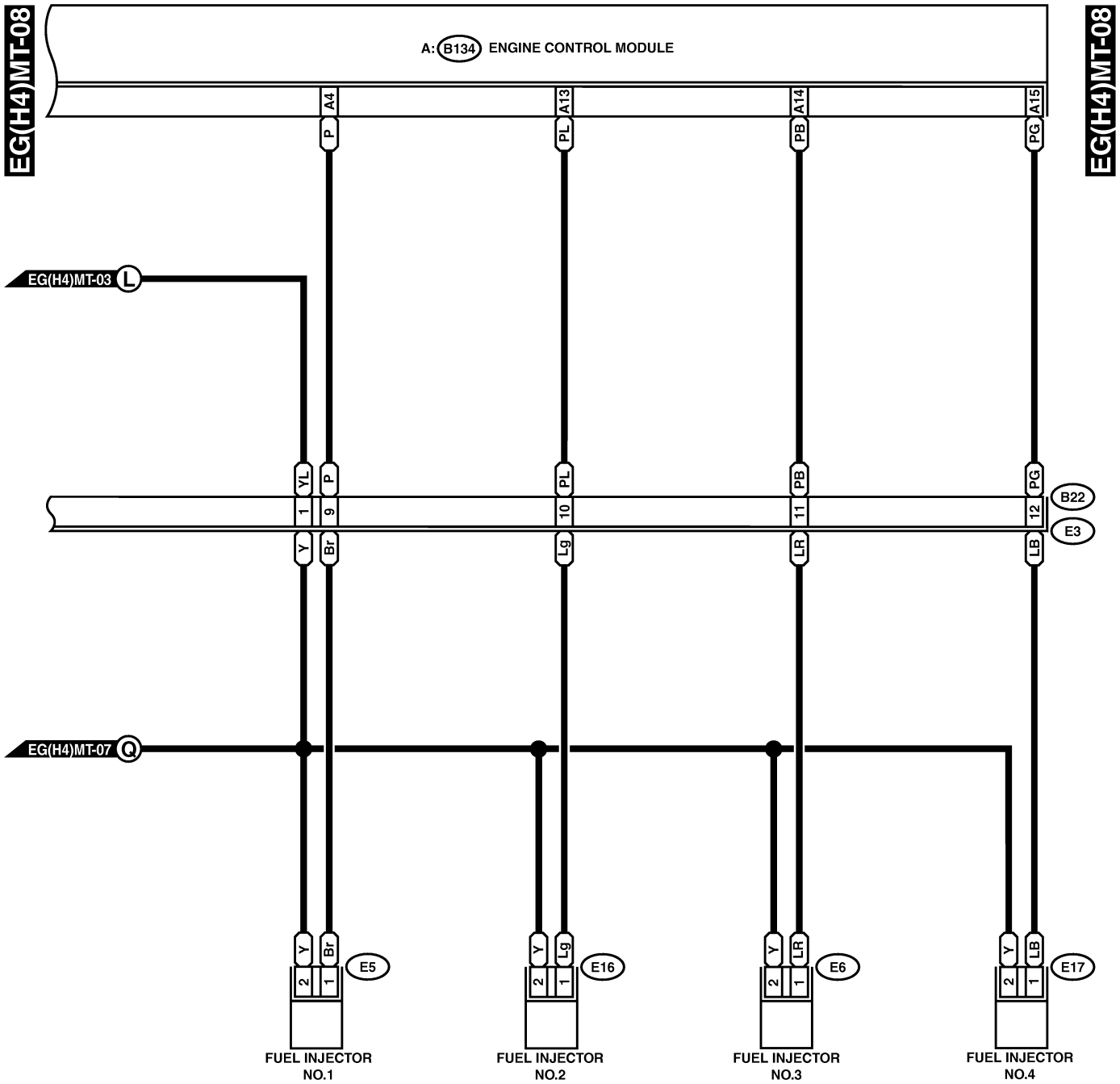

E5 (GRAY)

E6 (GRAY)

E16 (GRAY)

E17 (GRAY)

1 **2**

B22 (BROWN)

1	2	3	4
5	6	7	8
9	10	11	12
13	14	15	16

A: B134

1	2	3	4	5	6	7	8
9	10	11	12	13	14	15	16
17	18	19	20	21	22	23	24
25	26	27	28	29	30	31	32
33	34	35					

ENGINE ELECTRICAL SYSTEM

Wiring System

2. 4-CYLINDER ENGINE AT MODEL S903482A2104

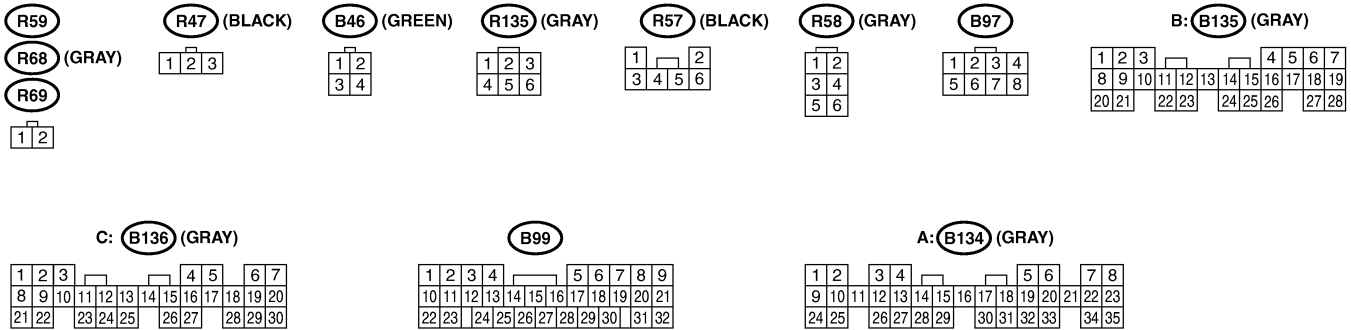
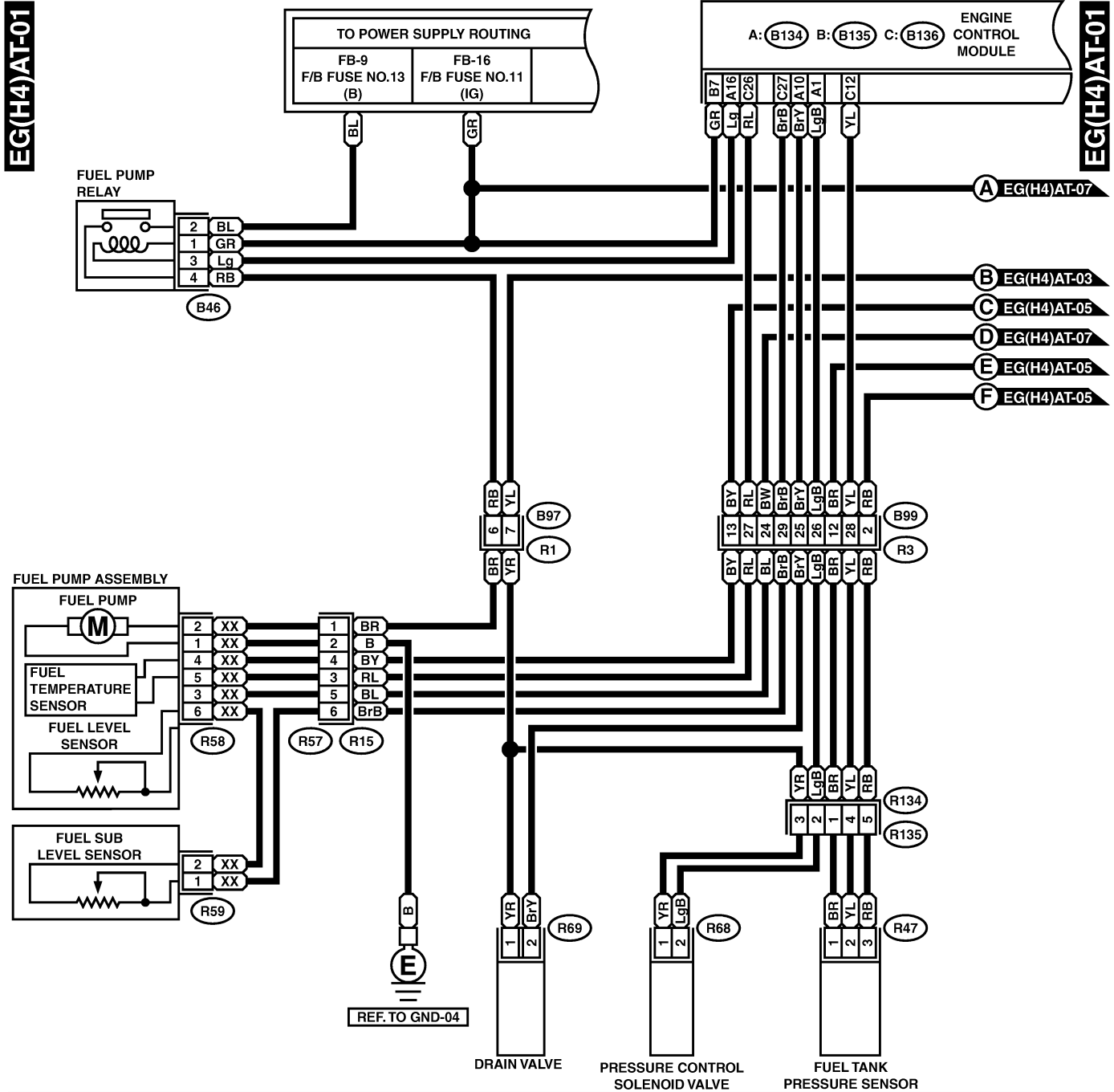

ENGINE ELECTRICAL SYSTEM

Wiring System

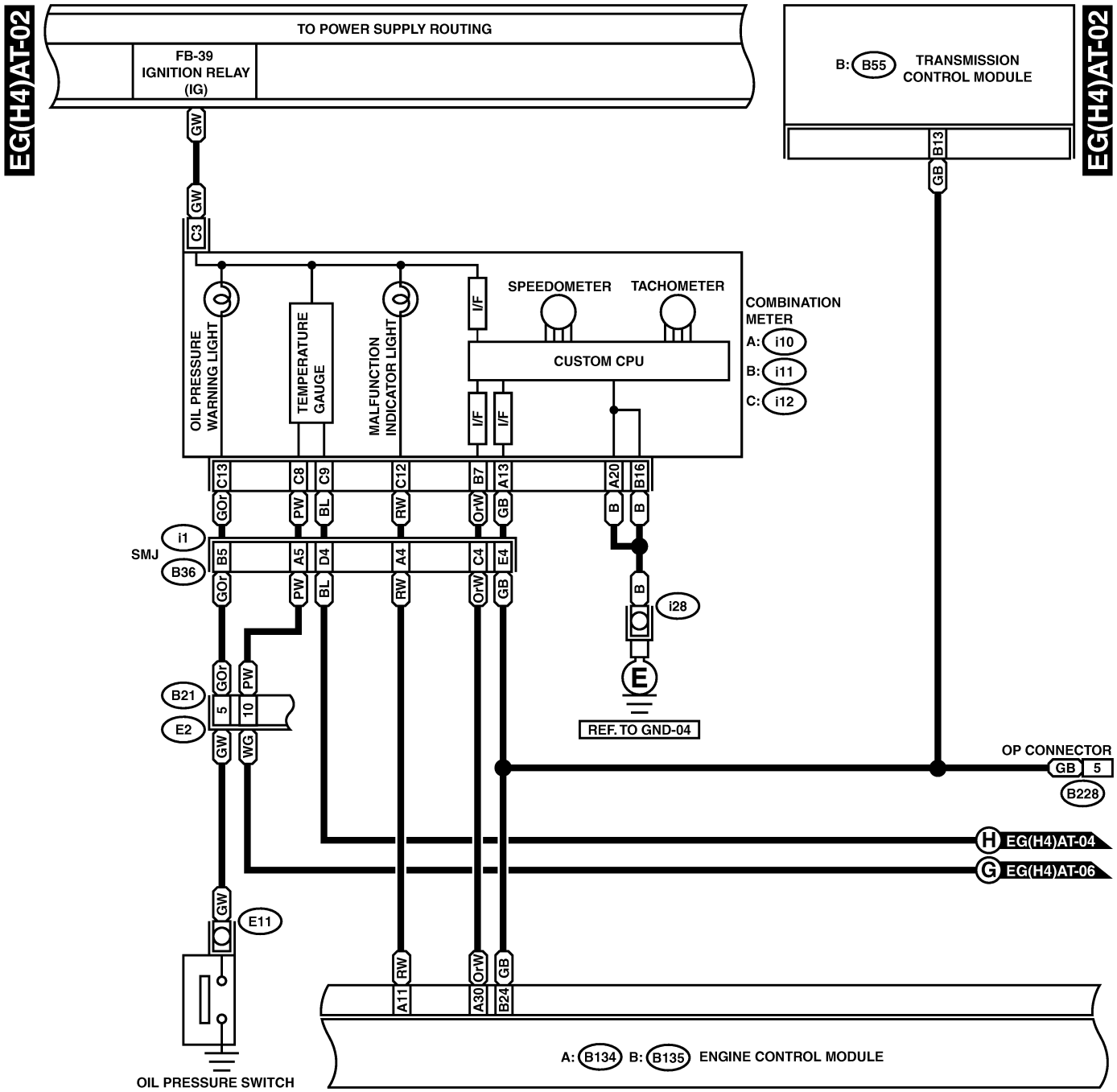

C: i12 (GREEN)

1	2	3	4	5	6
7	8	9	10	11	12
13	14				

B228

1	2	3
4	5	6
7	8	9
10	11	12
13	14	15

B: i11 (GREEN)

1	2	3	4	5	6	7
8	9	10	11	12	13	14
15	16					

B21 (GRAY)

1	2	3	4
5	6	7	8
9	10	11	12
13	14	15	16
17	18	19	20

B: B55 (GRAY)

1	2	3	4	5	6	7	8	9
10	11	12	13	14	15	16	17	18
19	20	21				22	23	24

B: R135 (GRAY)

1	2	3	4	5	6	7
8	9	10	11	12	13	14
15	16	17	18	19		
20	21	22	23	24	25	26
27	28					

A: i10 (GREEN)

1	2	3	4	5	6	7	8	9	10	11	12	13	14
15	16	17	18	19	20	21	22	23	24	25	26	27	28
29	30												

A: B134 (GRAY)

1	2	3	4	5	6	7	8
9	10	11	12	13	14	15	16
17	18	19	20	21	22	23	
24	25	26	27	28	29	30	31
32	33	34	35				

ENGINE ELECTRICAL SYSTEM

Wiring System

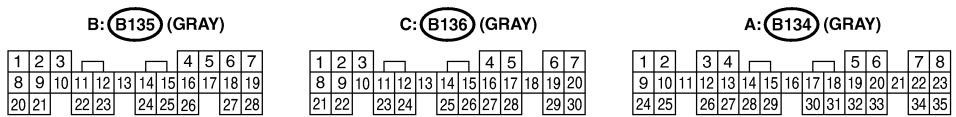
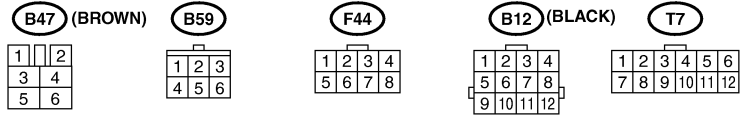
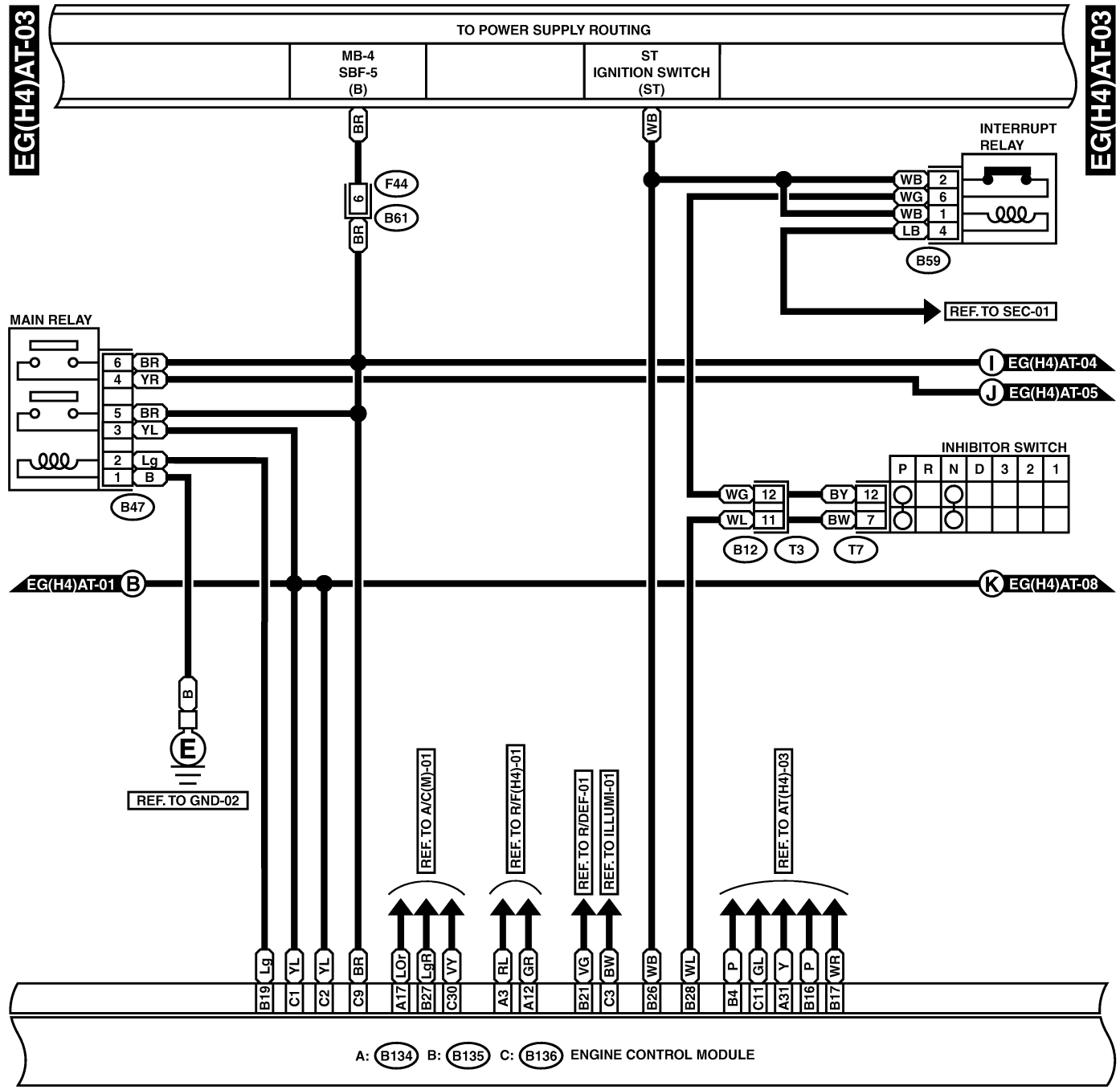

ENGINE ELECTRICAL SYSTEM

Wiring System

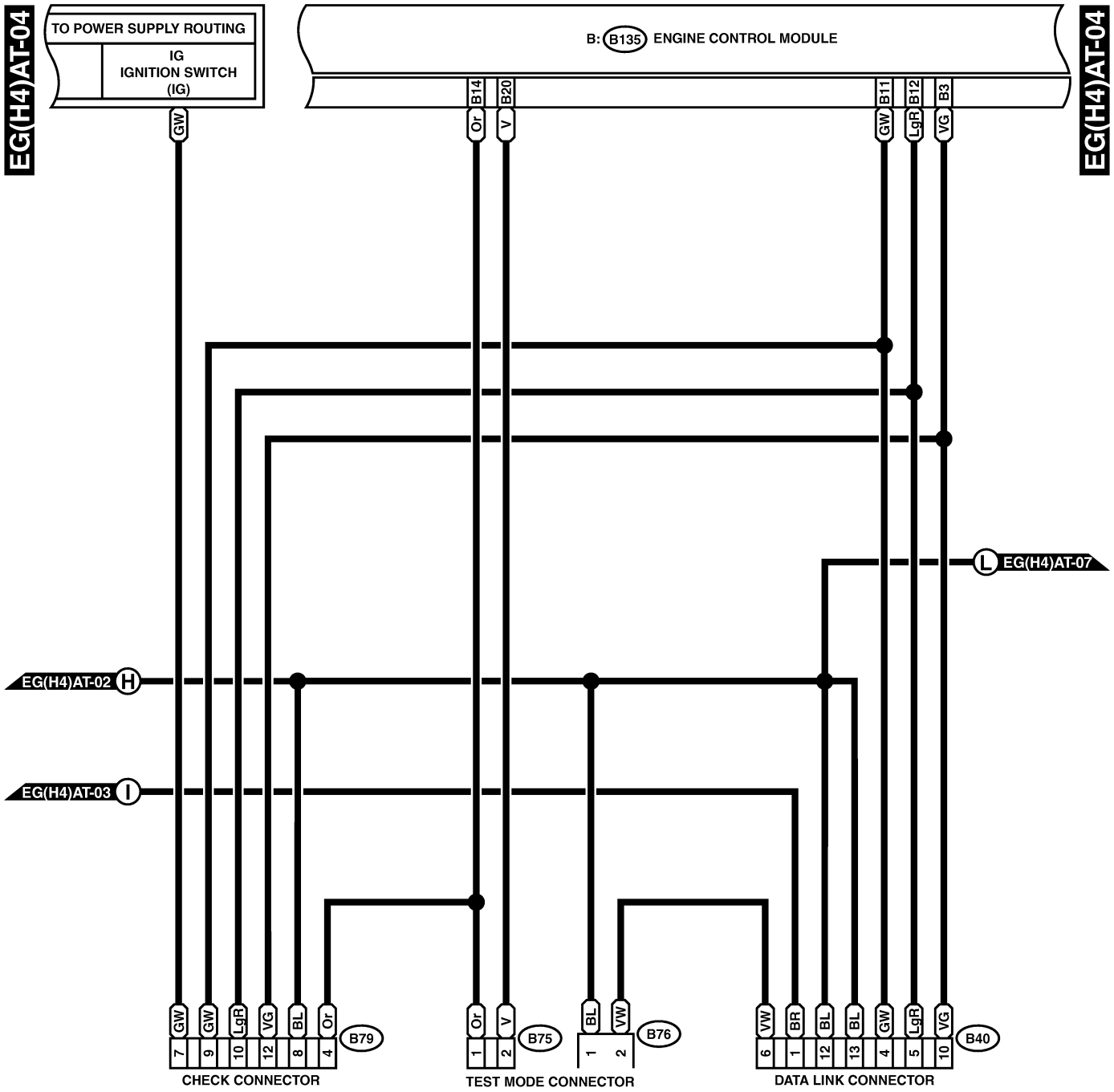

B75 (GREEN)



B76 (GREEN)



B79 (GRAY)

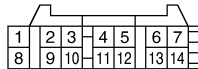

B40 (GRAY)

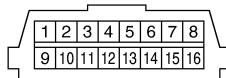

B: (B135) (GRAY)



ENGINE ELECTRICAL SYSTEM

Wiring System

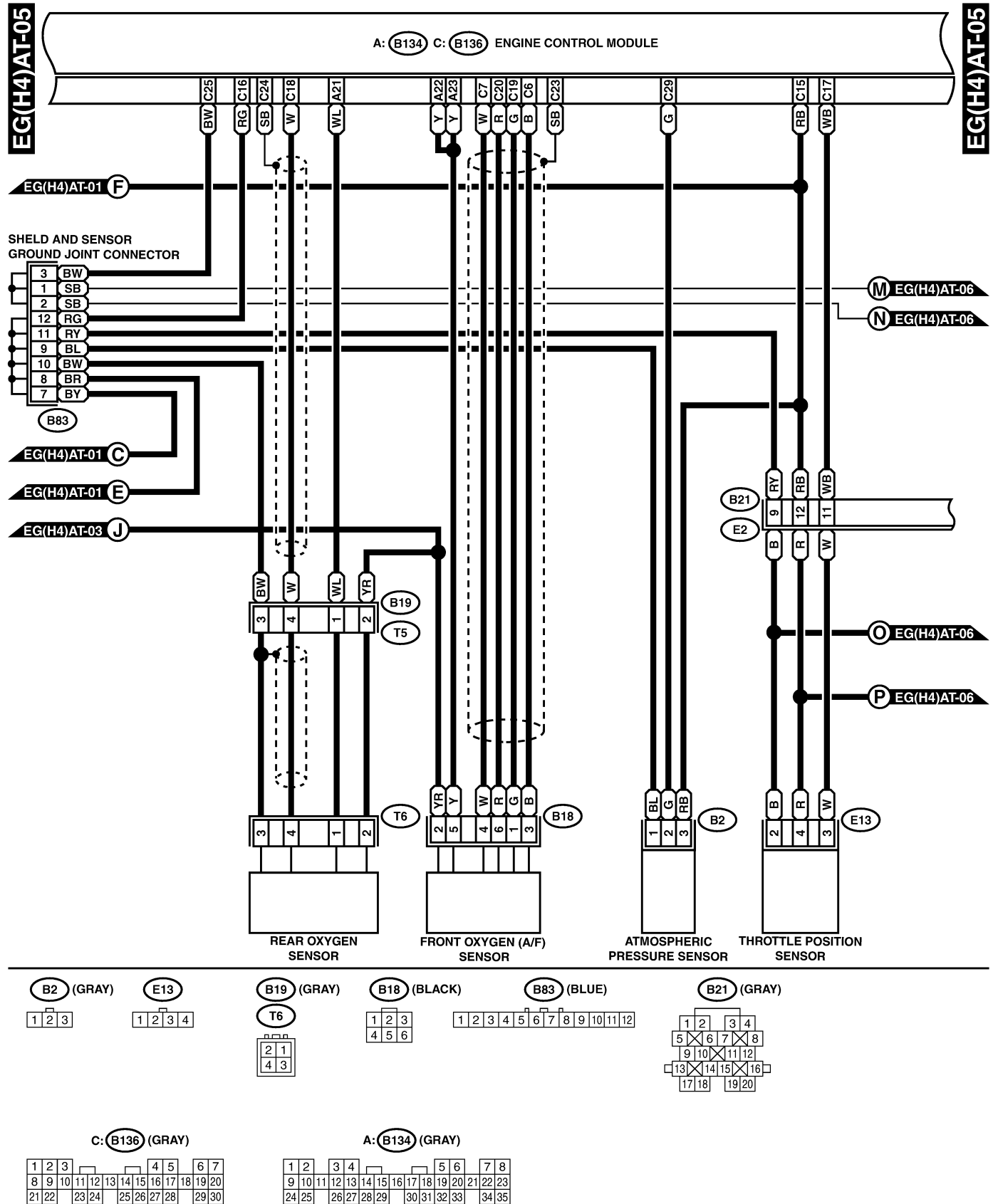

BU10-22E

ENGINE ELECTRICAL SYSTEM

Wiring System

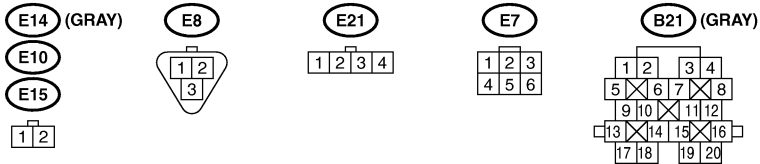
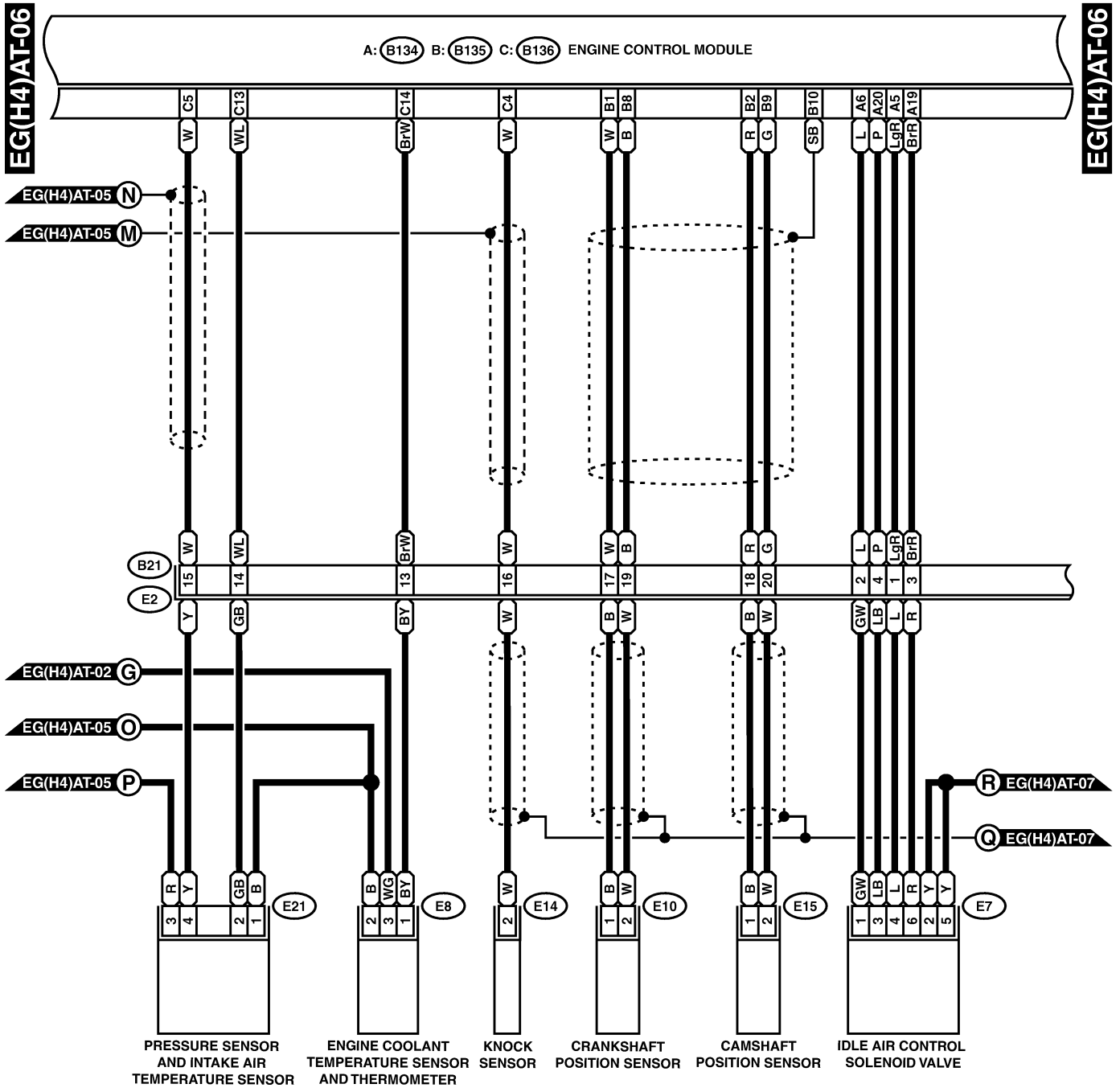

B: B135 (GRAY)



C: B136 (GRAY)

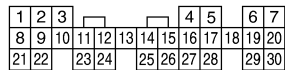

A: B134 (GRAY)

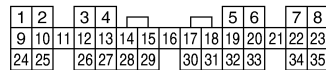

ENGINE ELECTRICAL SYSTEM

Wiring System

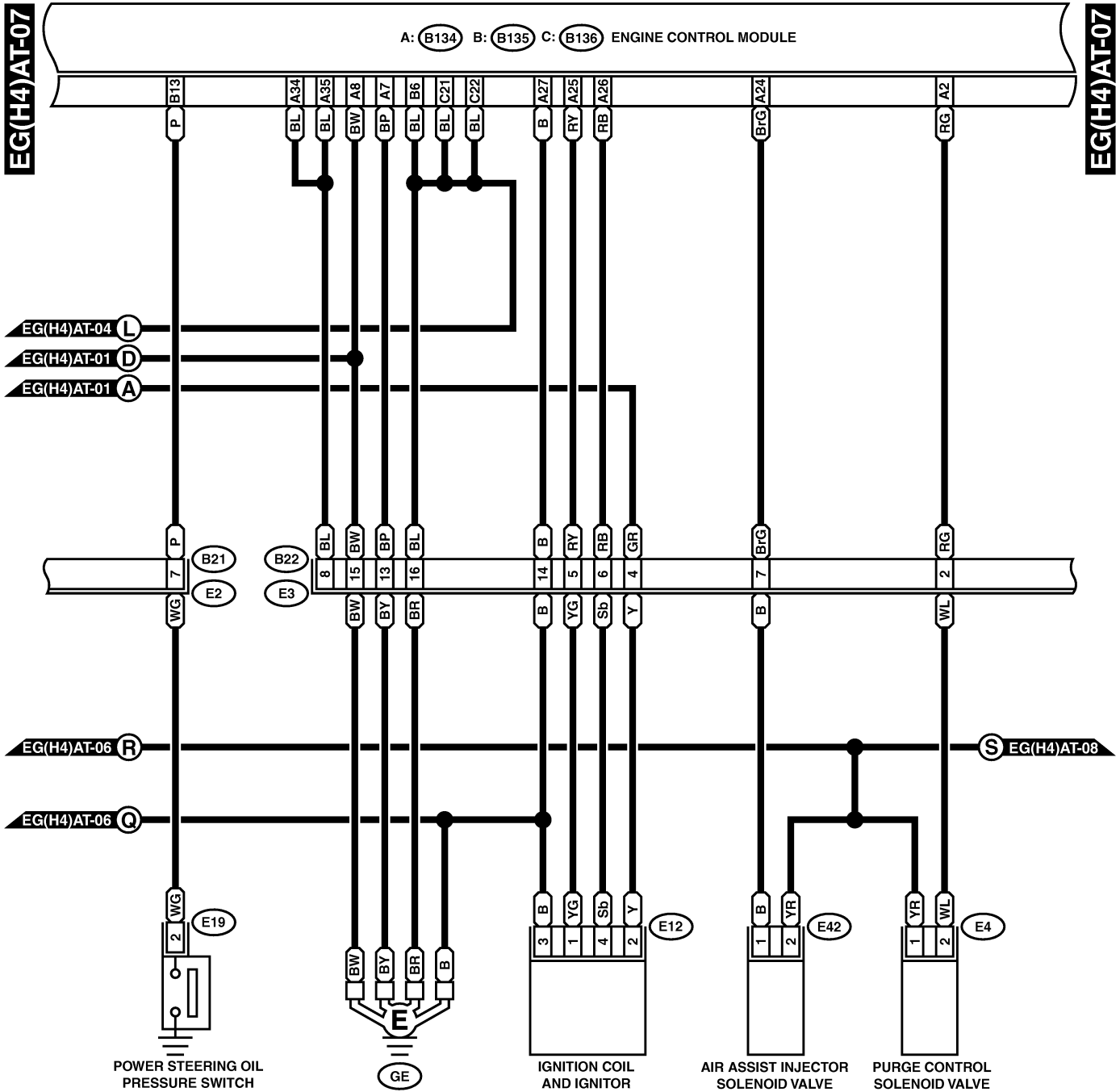

E4 (BLUE) E12 (DARK GRAY) B22 (BROWN) B21 (GRAY)

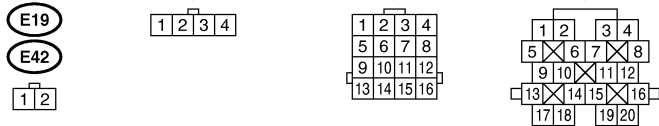

B: B135 (GRAY)

C: B136 (GRAY)

A: B134 (GRAY)

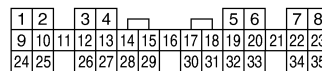
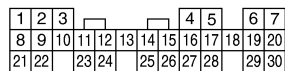

ENGINE ELECTRICAL SYSTEM

Wiring System

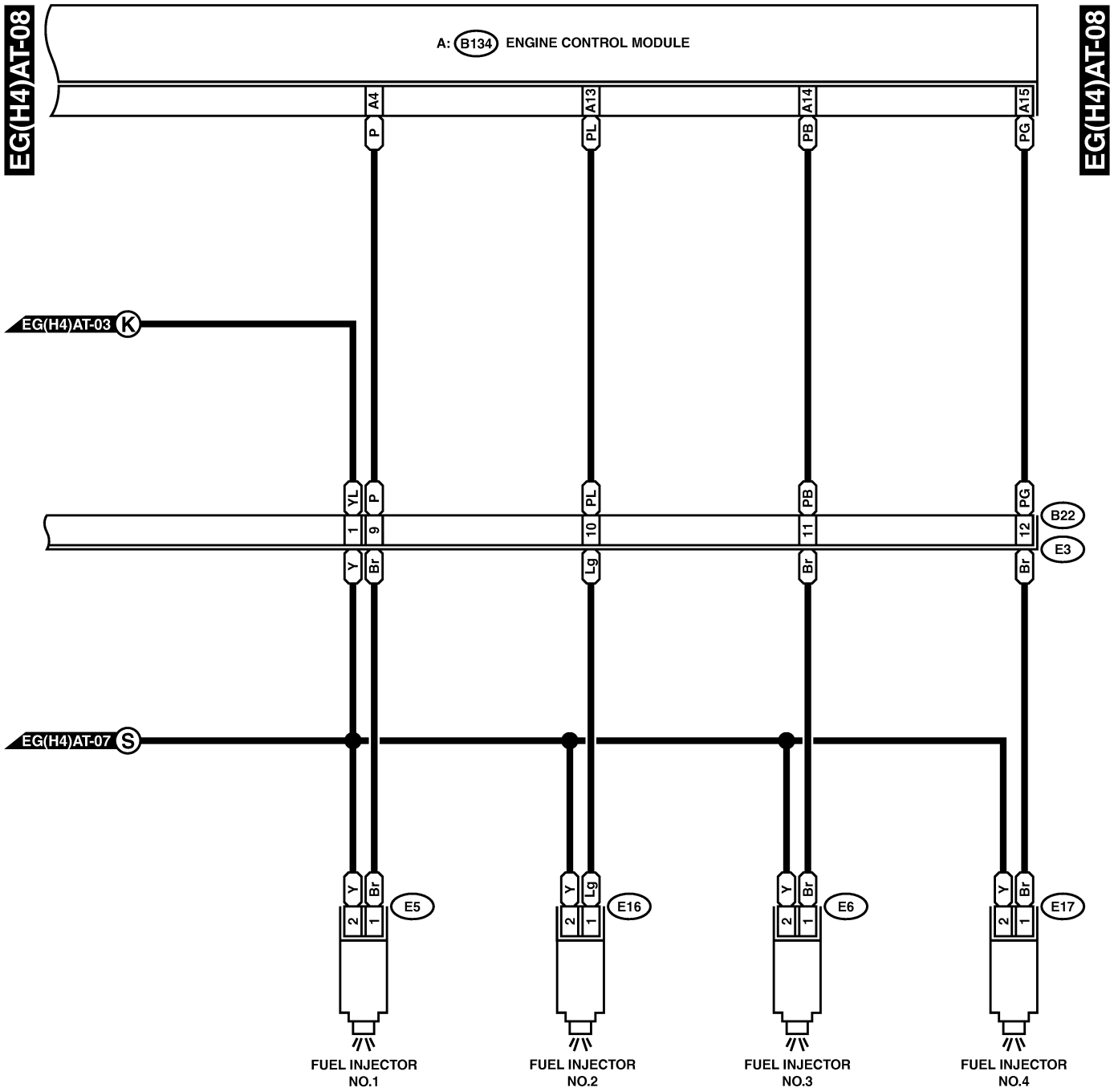

E5 (GRAY) E16 (GRAY)
E6 (GRAY) E17 (GRAY)



B22 (BROWN)

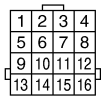

A: B134 (GRAY)

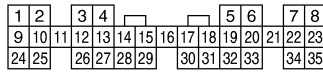

ENGINE ELECTRICAL SYSTEM

Wiring System

3. 6-CYLINDER ENGINE MODEL S903482A2105

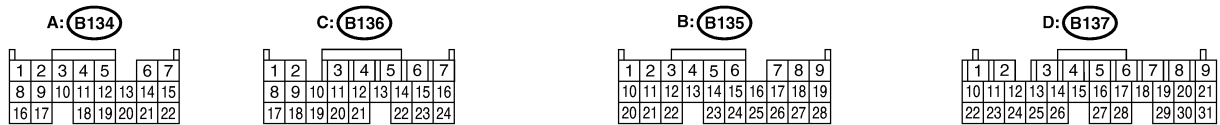
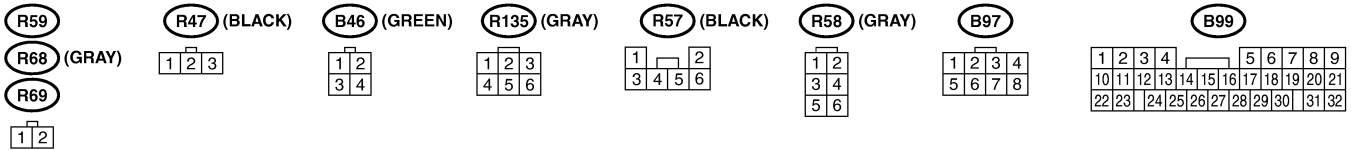
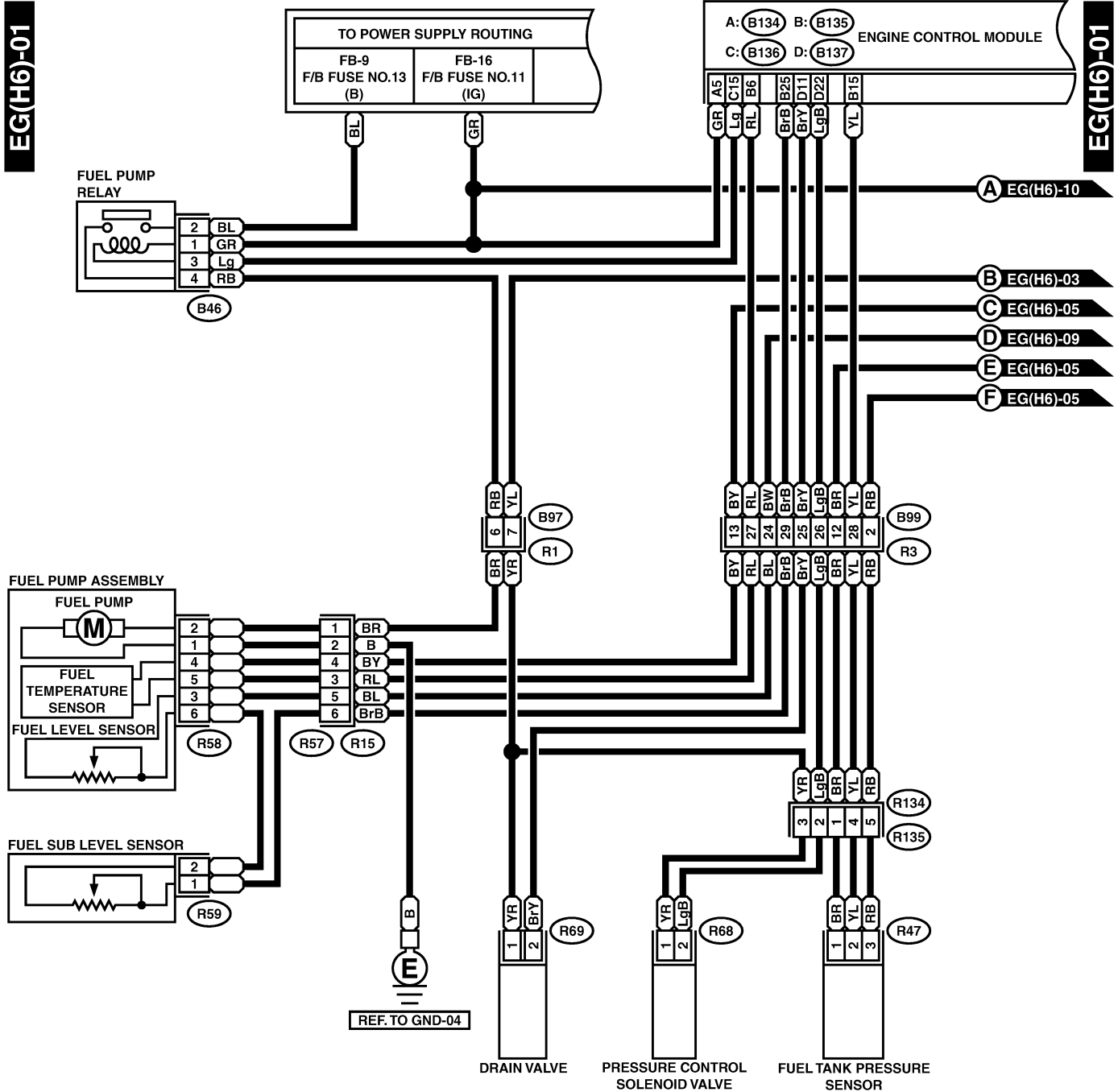

ENGINE ELECTRICAL SYSTEM

Wiring System

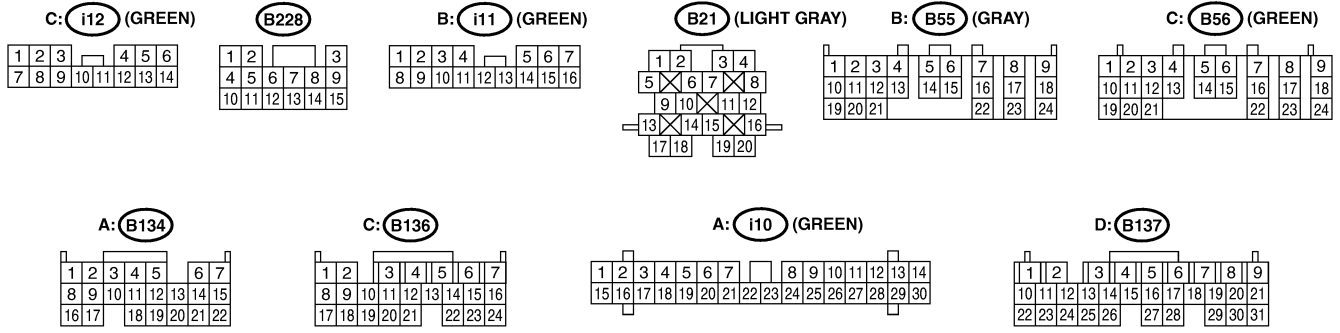
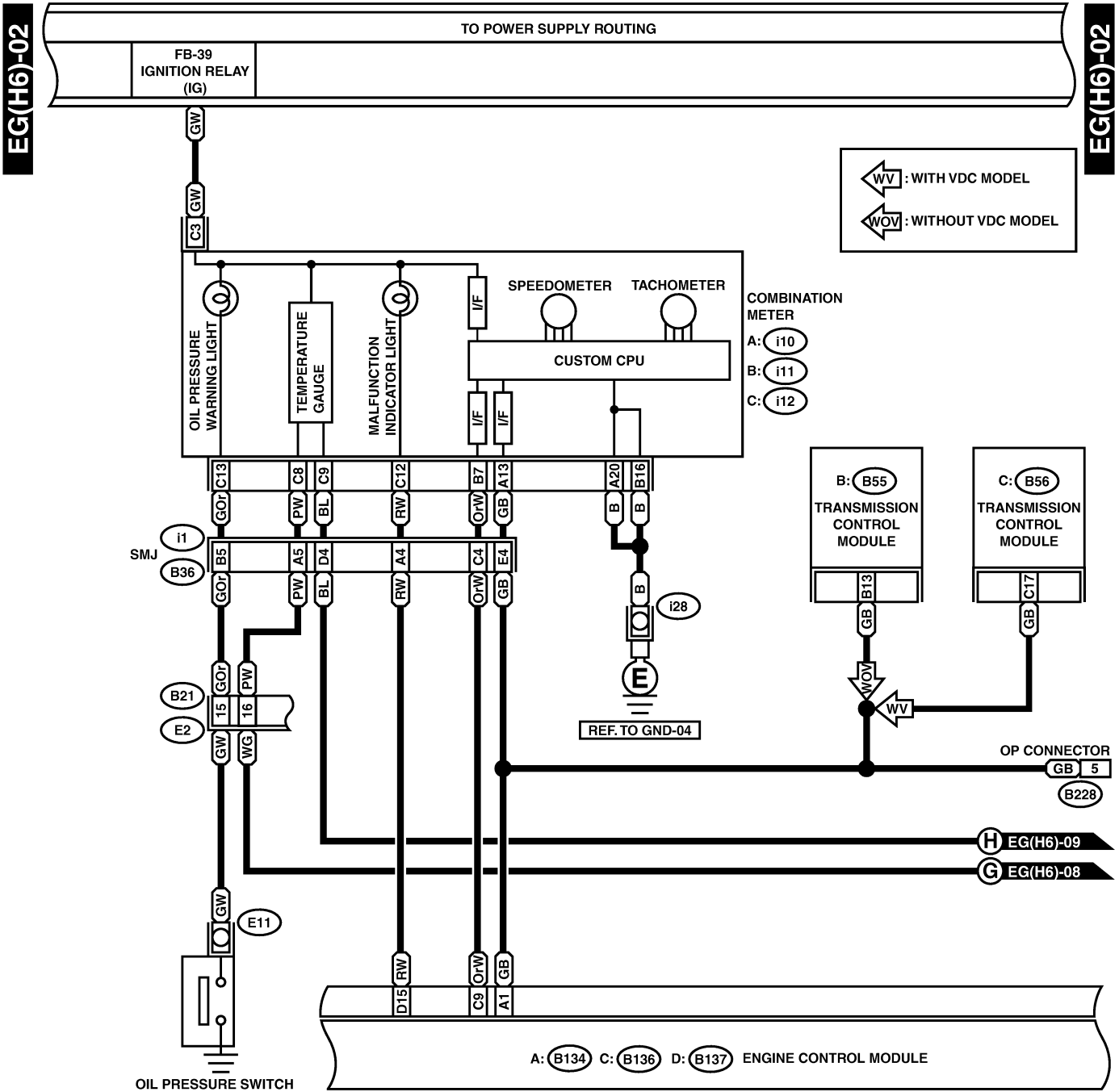

ENGINE ELECTRICAL SYSTEM

Wiring System

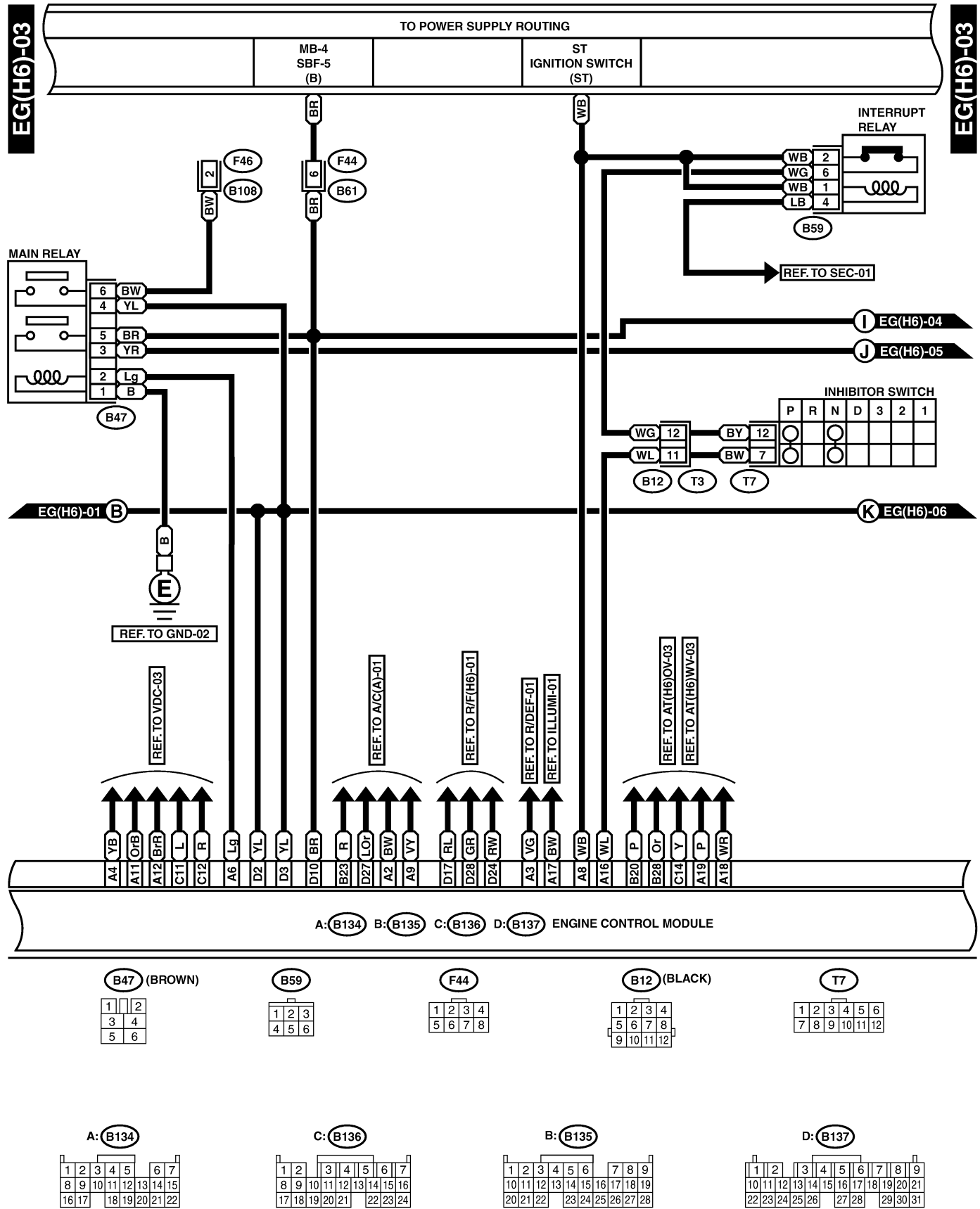

ENGINE ELECTRICAL SYSTEM

Wiring System

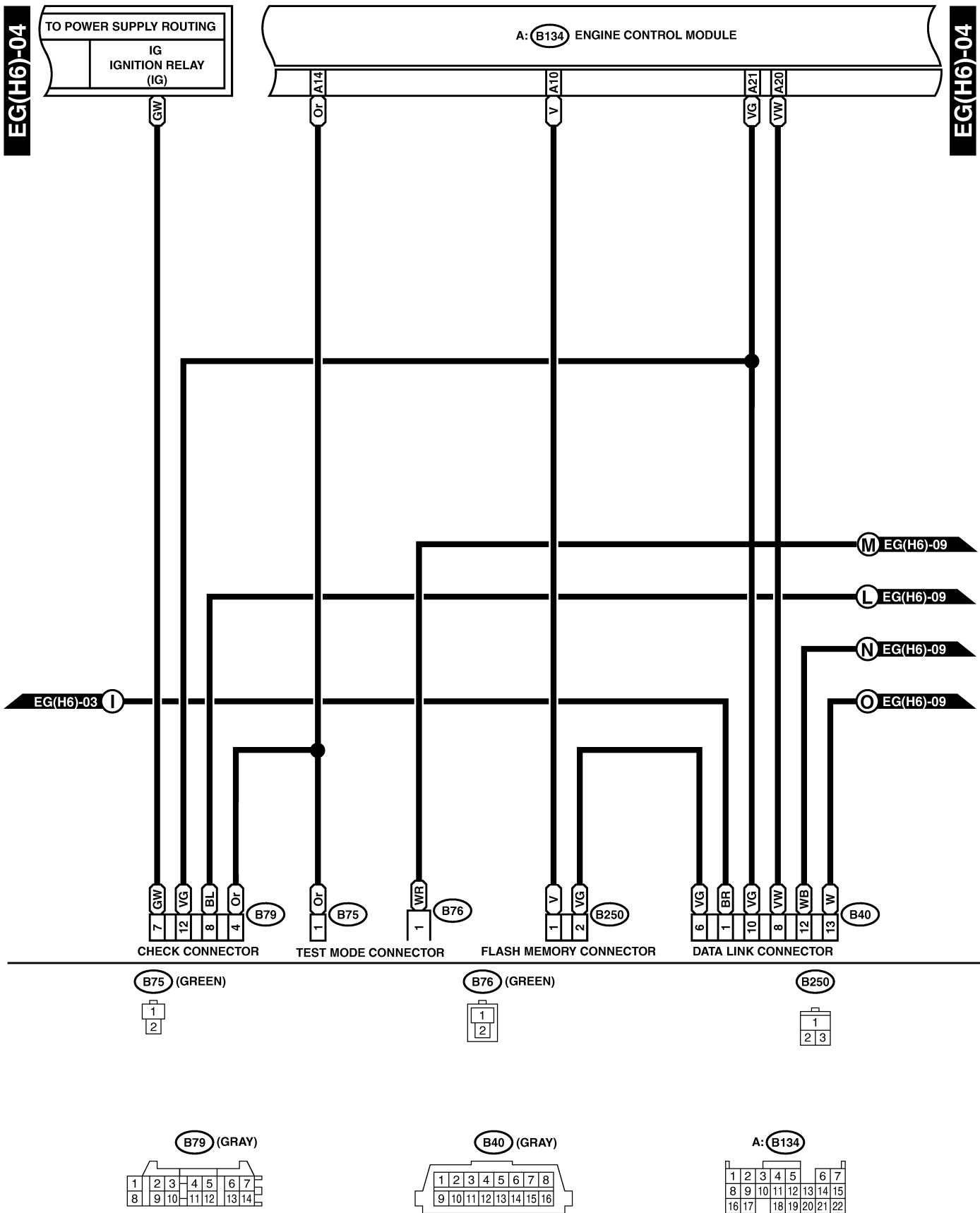

BU10-23D

ENGINE ELECTRICAL SYSTEM

Wiring System

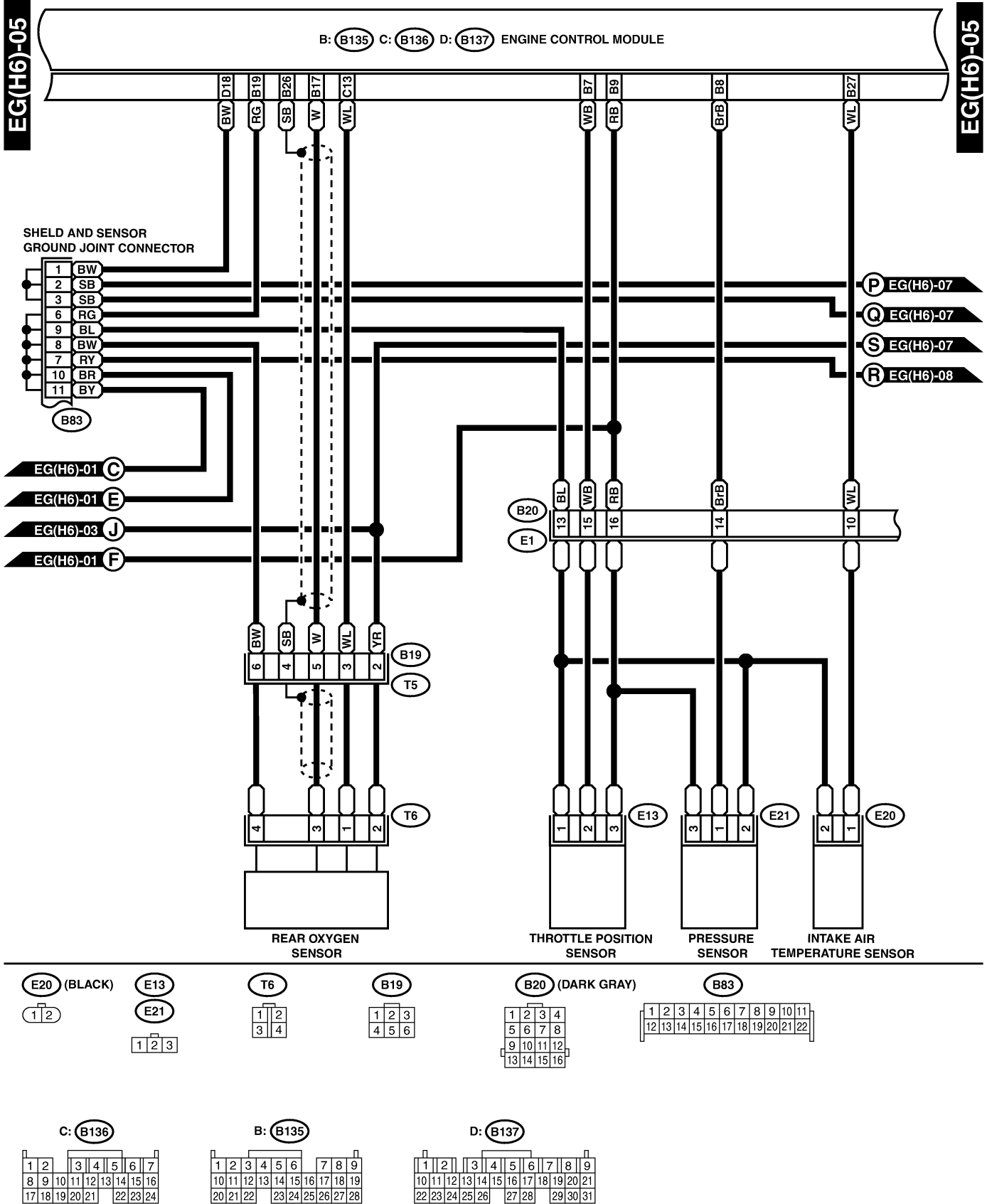

ENGINE ELECTRICAL SYSTEM

Wiring System

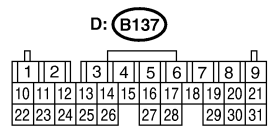
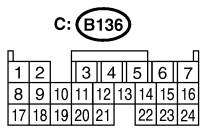
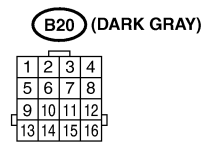
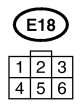
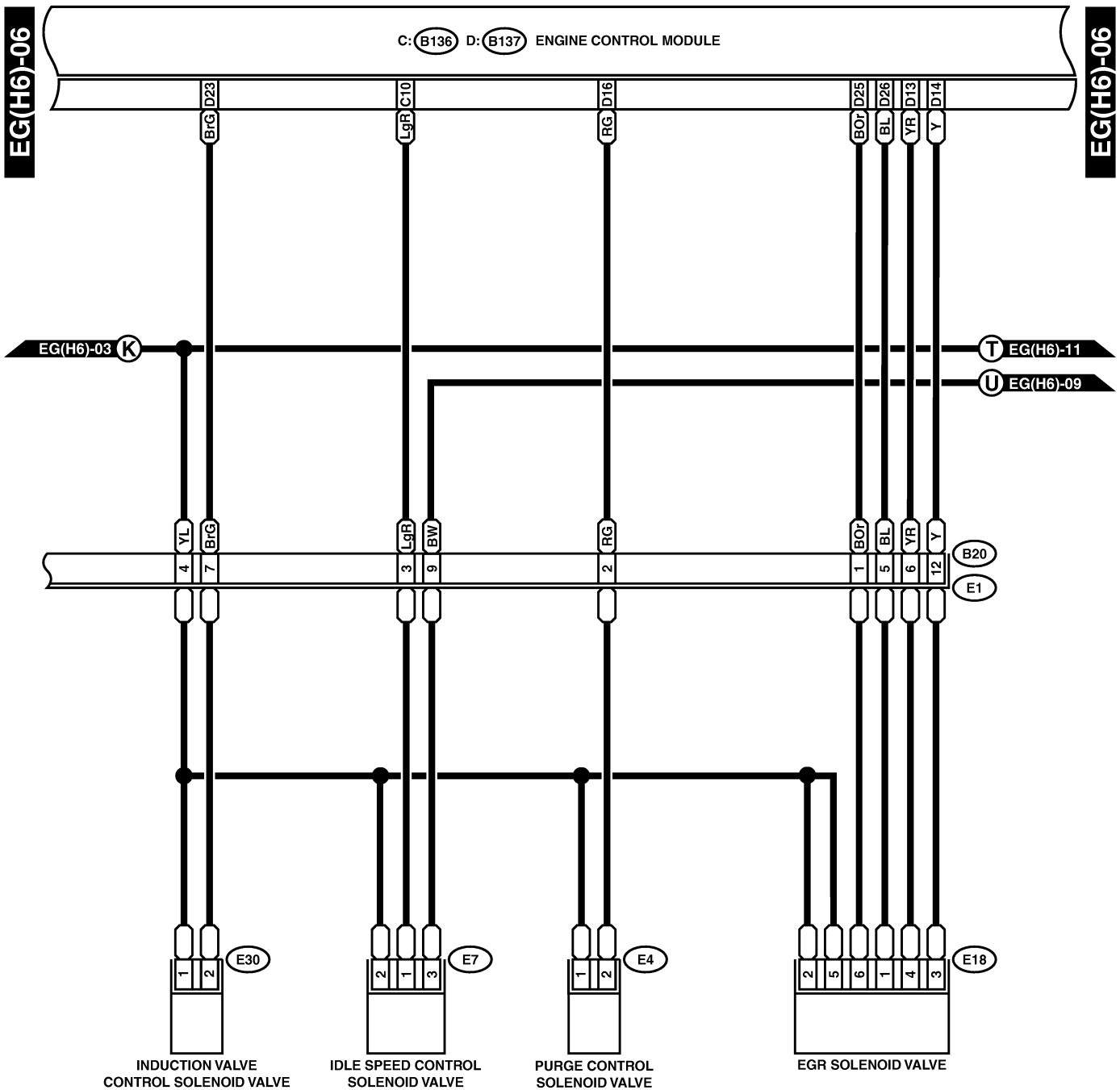

ENGINE ELECTRICAL SYSTEM

Wiring System

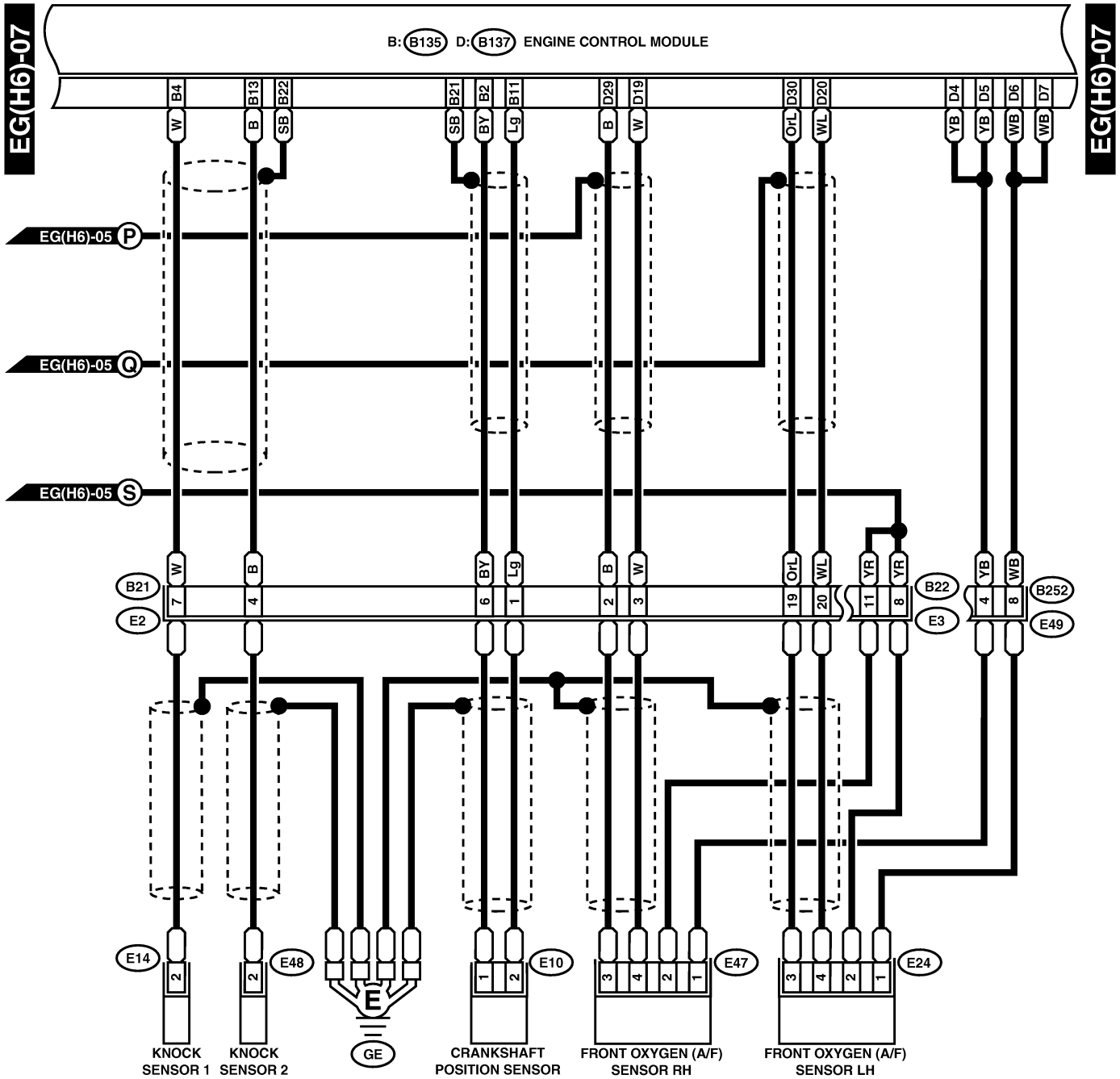

E14

E48



E10



E24

E47



B252 (DARK GRAY)

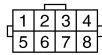

B22 (BROWN)

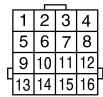

B21 (LIGHT GRAY)

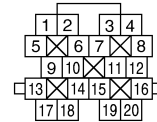

B: B135



D: B137

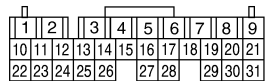

ENGINE ELECTRICAL SYSTEM

Wiring System

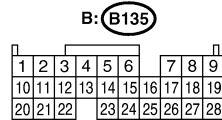
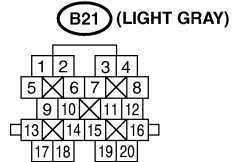
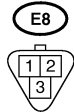
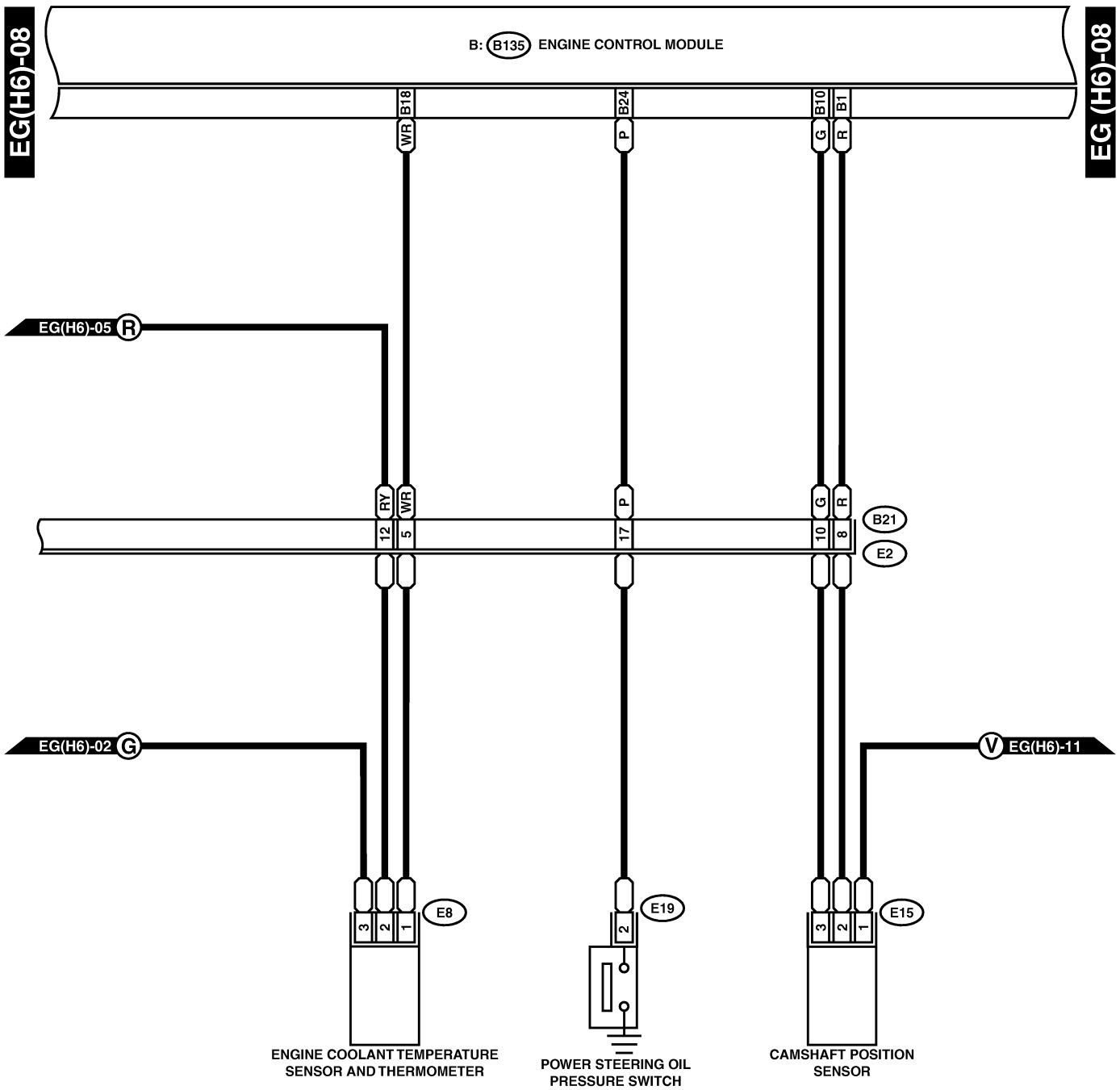

ENGINE ELECTRICAL SYSTEM

Wiring System

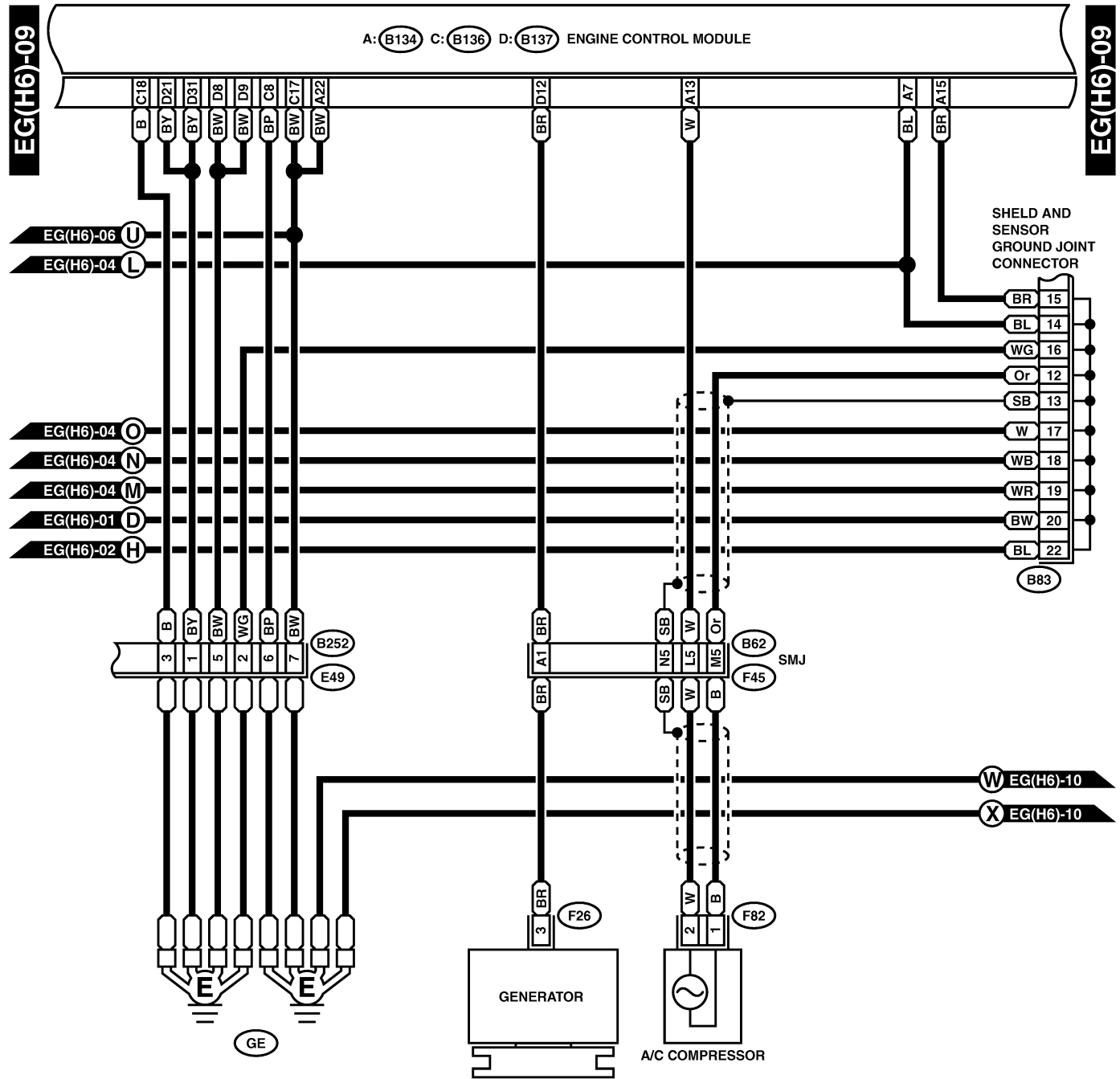

E26 (GREEN)

F82 (BLACK)



B252 (DARK GRAY)

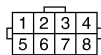

B83

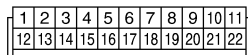

A: B134

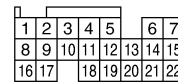

C: B136

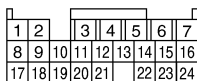

D: B137

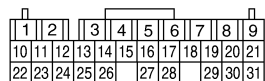

ENGINE ELECTRICAL SYSTEM

Wiring System

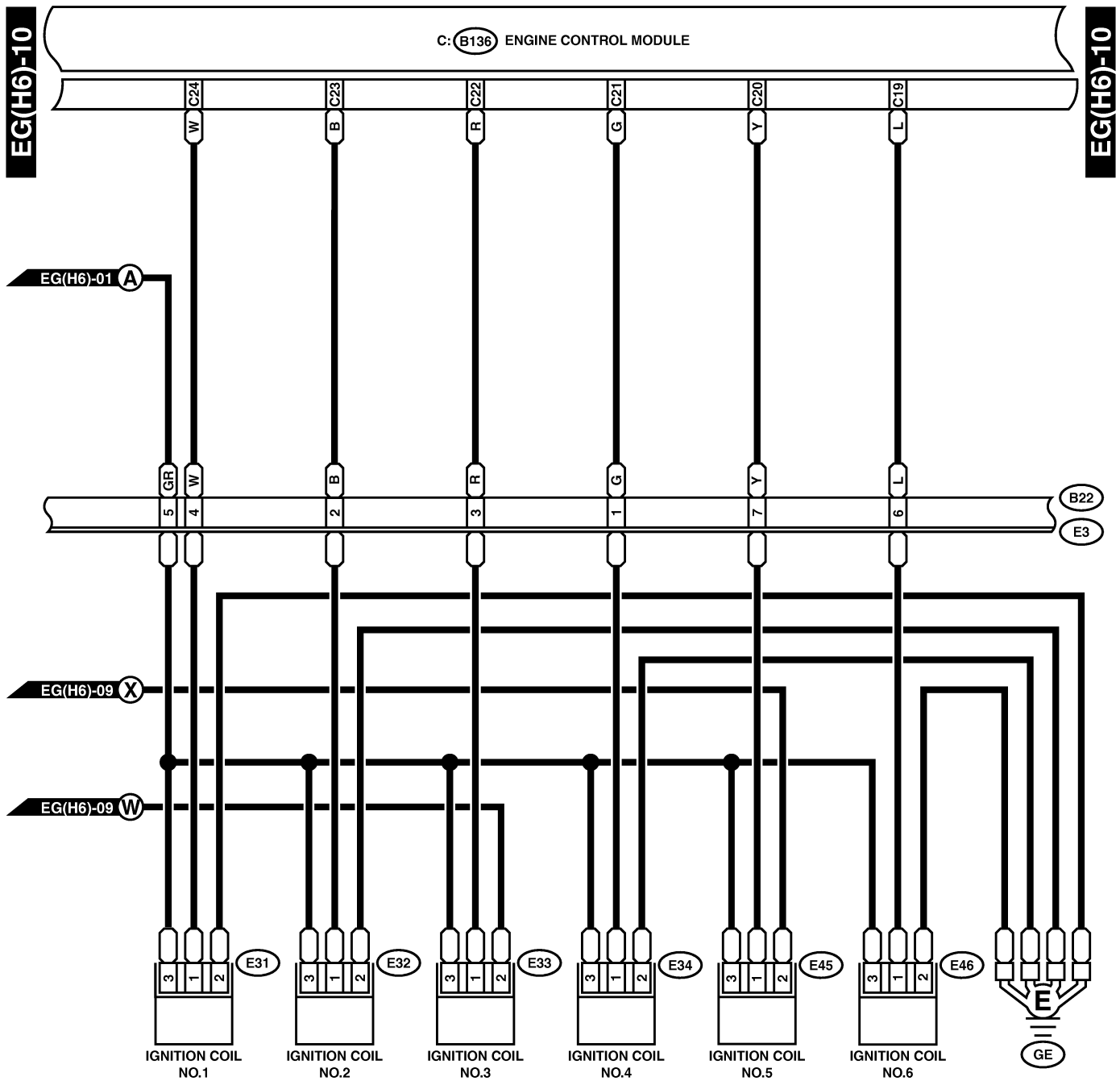

(BLACK) E31 (BLACK) E34
 (BLACK) E32 (BLACK) E45
 (BLACK) E33 (BLACK) E46

1
2
3

B22 (BROWN)

1	2	3	4
5	6	7	8
9	10	11	12
13	14	15	16

C: B136

1	2	3	4	5	6	7
8	9	10	11	12	13	14
15	16	17	18	19	20	21
22	23	24				

ENGINE ELECTRICAL SYSTEM

Wiring System

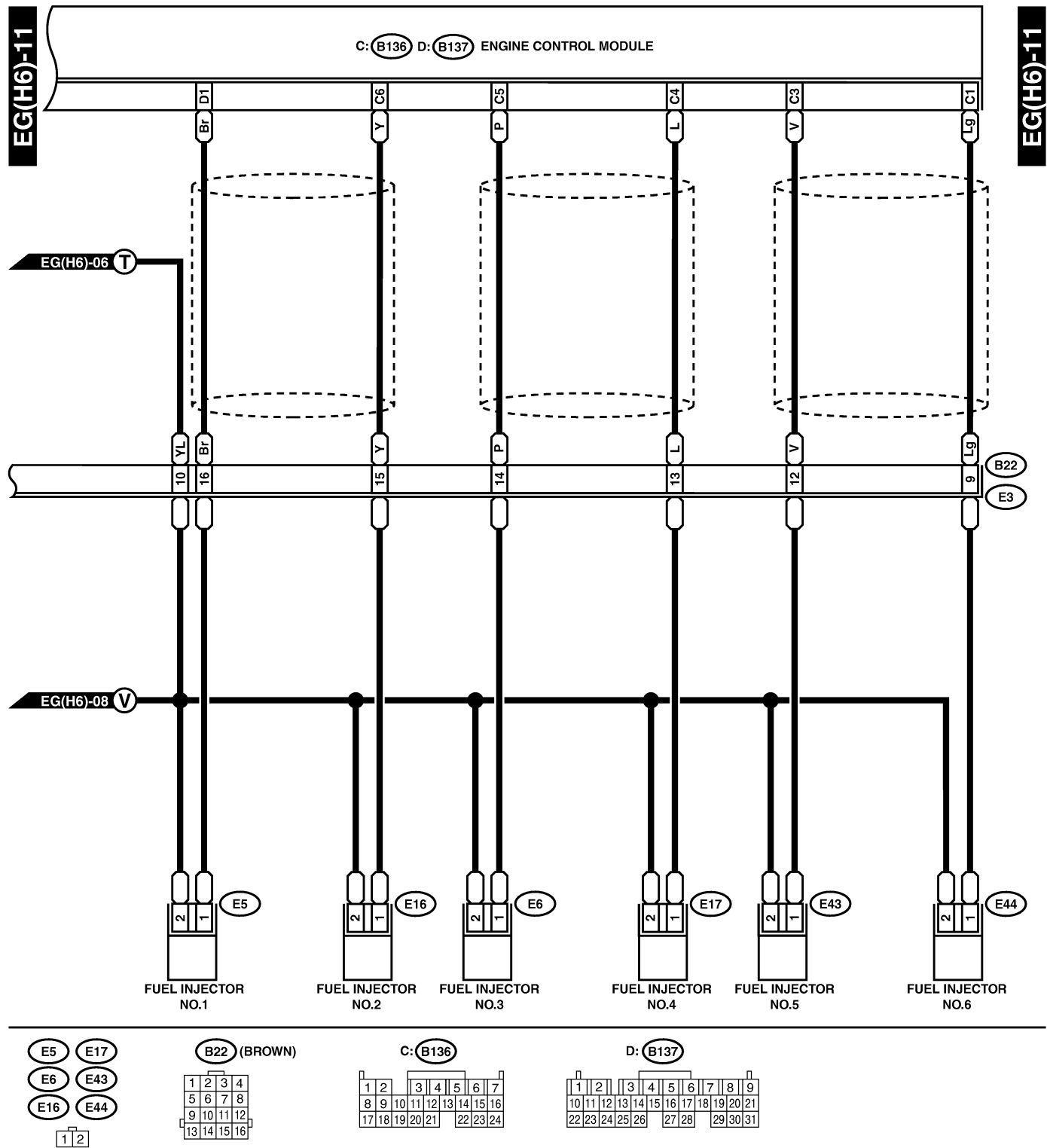

BU10-23K