

SEAT BELT WARNING SYSTEM

Wiring System

39. Seat Belt Warning System S903483

A: SCHEMATIC S903483A21

S/BELT-01

S/BELT-01

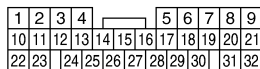
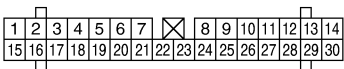
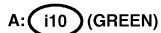
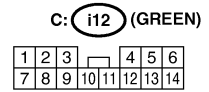
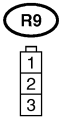
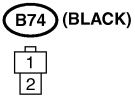
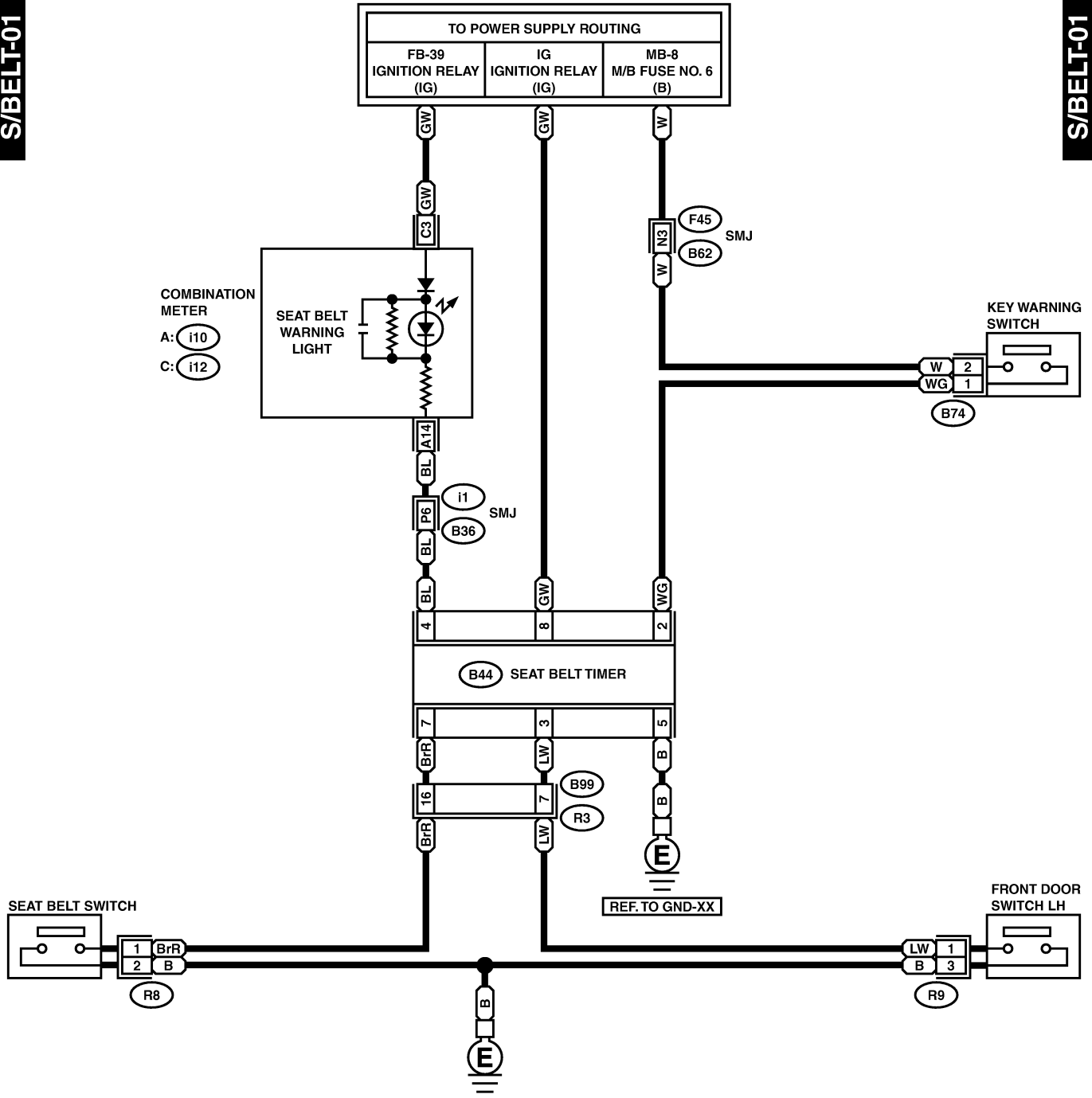

BU87-21