

## 19. Fuel Tank S175053

### A: REMOVAL S175053A18

- 1) Set vehicle on the lift.
- 2) Release fuel pressure. <Ref. to FU-54, RELEASING OF FUEL PRESSURE, OPERATION, Fuel.>
- 3) Drain fuel from fuel tank. <Ref. to FU-54, DRAINING FUEL, OPERATION, Fuel.>
- 4) Remove holder clip which secures fuel tank cord on bracket.

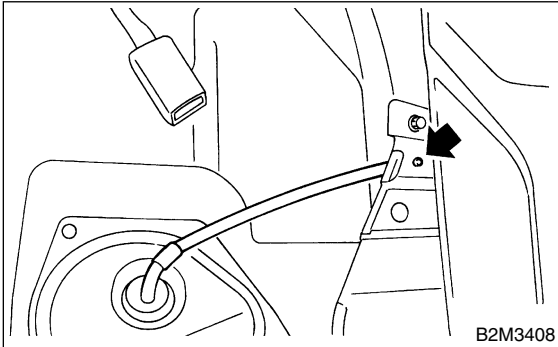

- 5) Disconnect connector of fuel tank cord to rear harness.

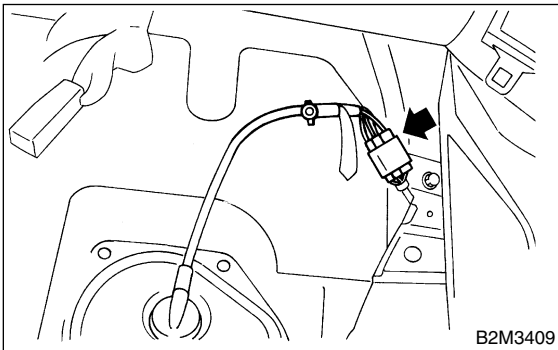

- 6) Push grommet which holds fuel tank cord on service hole cover into body side.

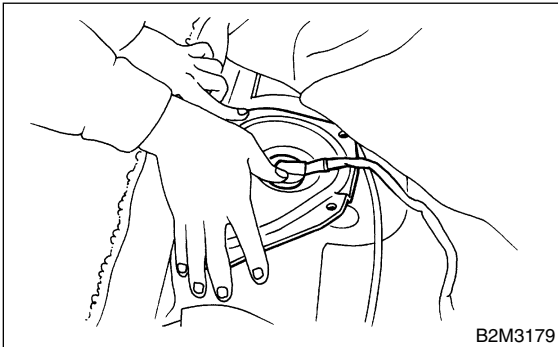

- 7) Separate quick connector of fuel delivery (A) and return hose (B). <Ref. to FU-81, REMOVAL, Fuel Delivery, Return and Evaporation Lines.>

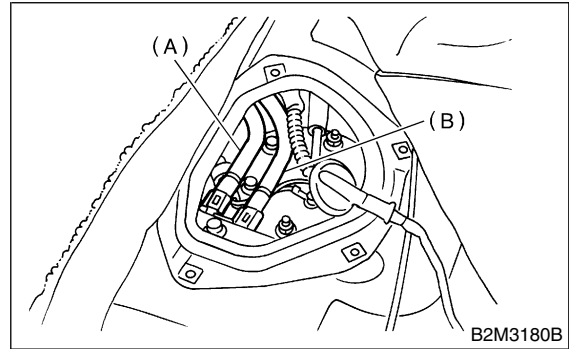

- 8) Remove parking brake cable.
  - (1) Remove console box console. <Ref. to EI-36, REMOVAL, Console Box.>
  - (2) Remove parking brake bracket and disconnect parking brake cable from equalizer. <Ref. to PB-5, REMOVAL, Parking Brake Cable.>
- 9) Remove trunk trim. (Sedan model) <Ref. to EI-51, REMOVAL, Trunk Trim.>
- 10) Remove rear quarter lower trim. (Wagon model) <Ref. to EI-44, WAGON, REMOVAL, Rear Quarter Trim.>
- 11) Remove pipe protector.

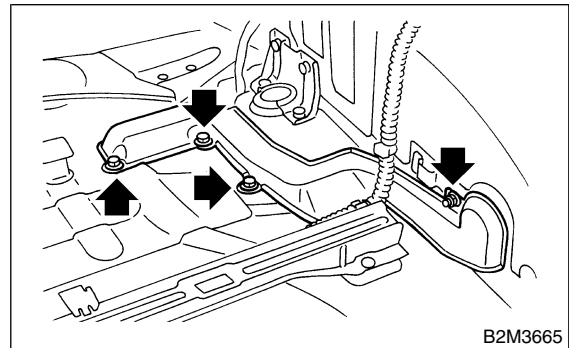

- 12) Separate quick connector of evaporation pipe (A). <Ref. to FU-81, REMOVAL, Fuel Delivery, Return and Evaporation Lines.>

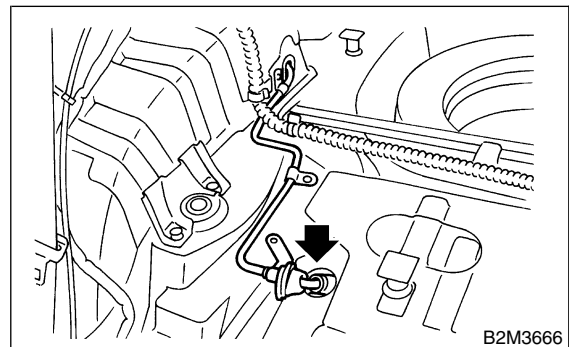

- 13) Remove wheel nuts from rear wheels.
- 14) Lift-up the vehicle.
- 15) Remove rear wheel.

# FUEL TANK

## Fuel Injection (Fuel Systems)

16) Remove front side fuel tank cover.

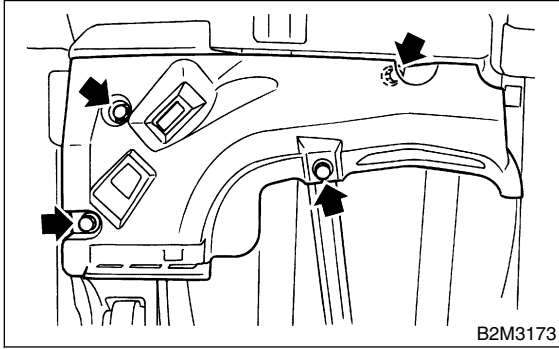

17) Remove rear exhaust pipe and muffler.

**NOTE:**

To facilitate removal, apply a coat of SUBARU CRC to matching area of rubber cushions in advance.

**SUBARU CRC (Part No. 004301003)**

(1) Separate rear exhaust pipe from center exhaust pipe.

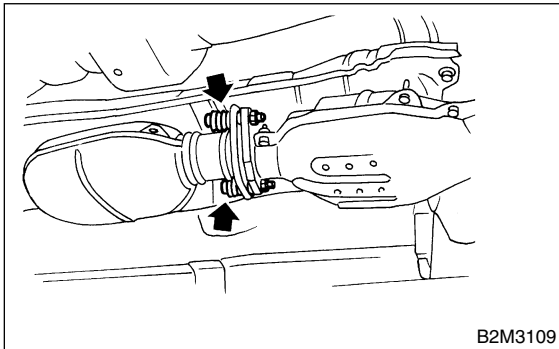

(2) Remove left and right rubber cushions.

**CAUTION:**

Be careful not to pull down muffler.

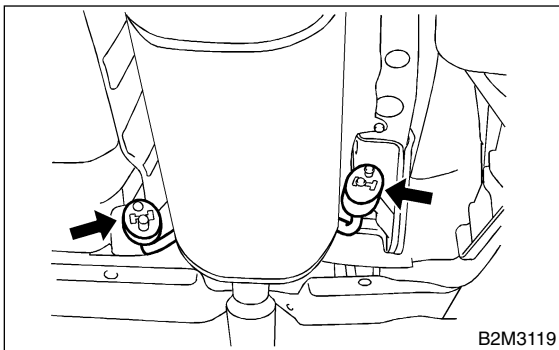

(3) Remove front rubber cushion and detach muffler assembly.

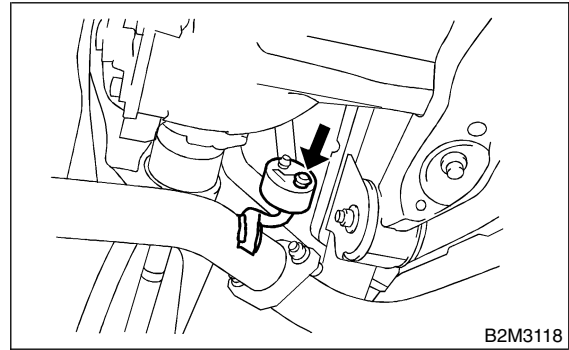

18) Remove propeller shaft. <Ref. to DS-13, REMOVAL, Propeller Shaft.>

19) Disconnect connector from ABS sensor.

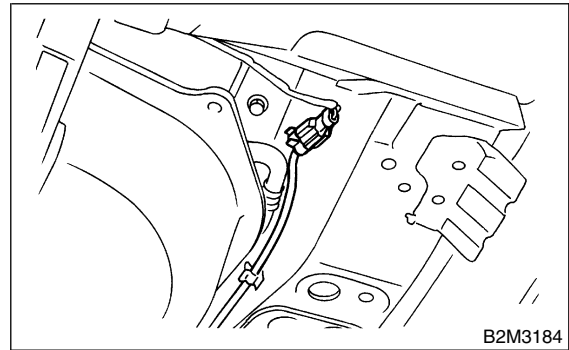

20) Remove bolts which hold parking brake cable holding bracket.

21) Remove parking brake cable from cabin by forcibly pulling it backward.

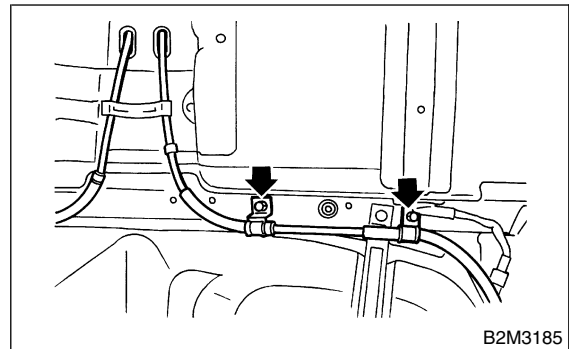

22) Remove bolts which hold parking brake cable holding bracket.

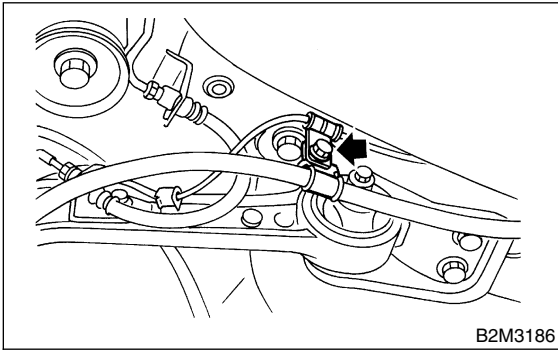

23) Remove bolts which hold rear brake hoses holding bracket.

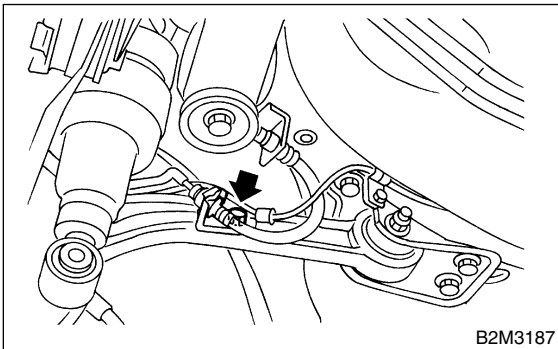

24) Remove rear brake caliper, then tie it up to the body side of the vehicle as shown in figure.

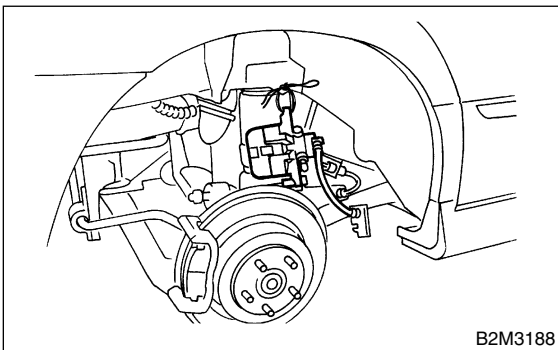

25) Remove rear suspension assembly.

**WARNING:**  
A helper is required to perform this work.

(1) Support rear differential with transmission jack.

(2) Remove bolt which holds rear shock absorber to rear suspension arm.

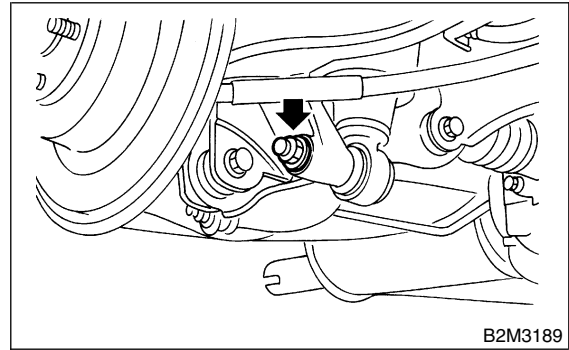

(3) Remove bolts which secure rear suspension assembly to body.

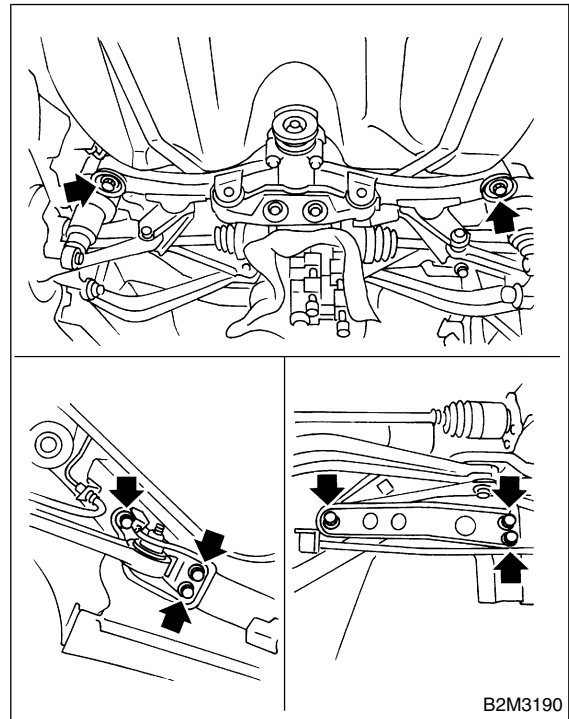

(4) Remove rear suspension assembly.  
26) Remove rear side fuel tank cover.

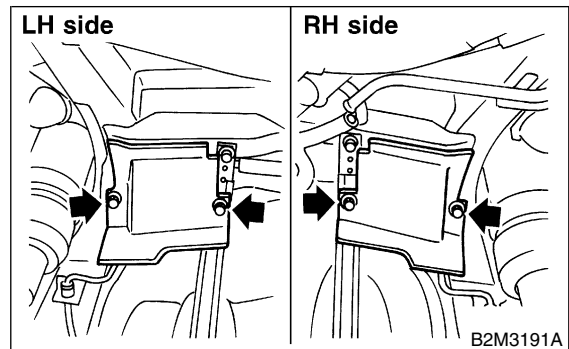

# FUEL TANK

## Fuel Injection (Fuel Systems)

27) Disconnect fuel filler hose (A) and fuel tank pressure sensor (B) hose.

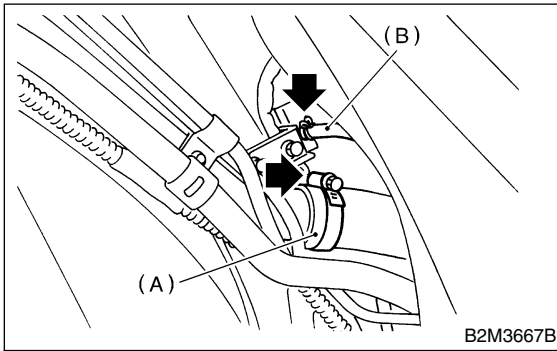

28) Disconnect air vent hose (A) from evaporation pipe assembly and disconnect evaporation hose (I) from pressure control solenoid valve.

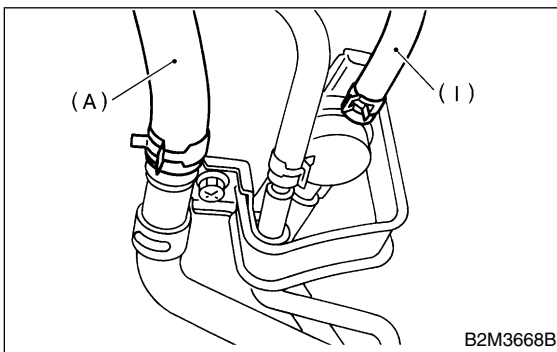

29) Support fuel tank with transmission jack, remove bolts from bands and dismount fuel tank from the vehicle.

**WARNING:**  
A helper is required to perform this work.

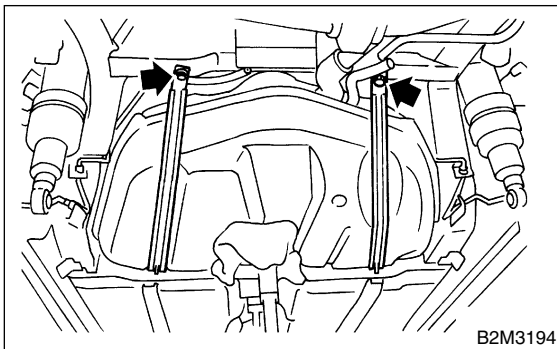

## B: INSTALLATION S175053A11

1) Support fuel tank with transmission jack and push fuel tank harness into access hole with grommet.

2) Set fuel tank and temporarily tighten bolts of fuel tank bands.

**WARNING:**  
A helper is required to perform this work.

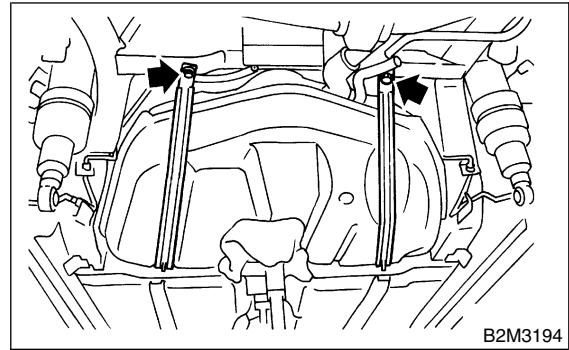

3) Connect air vent hose (A) to evaporation pipe assembly and connect evaporation hose (I) to pressure control solenoid valve.

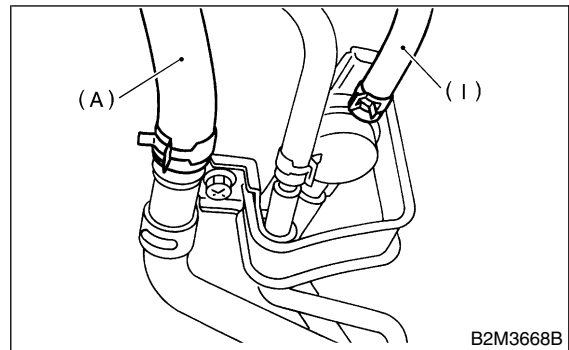

4) Connect fuel filler hose (A) and fuel tank pressure sensor hose (B).

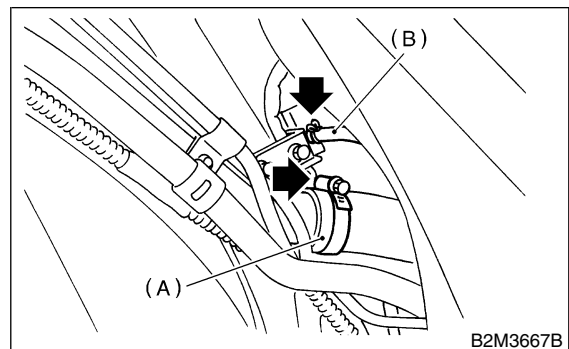

5) Tighten band mounting bolts.

**Tightening torque:**

**33 N·m (3.4 kgf·m, 25 ft·lb)**

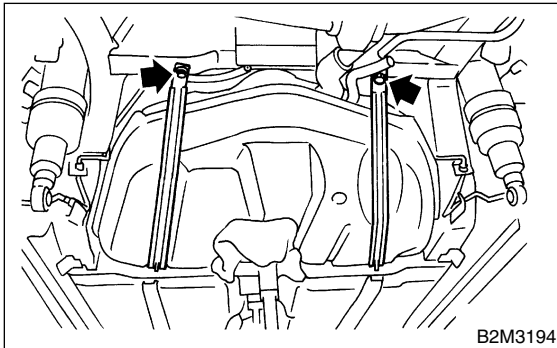

6) Install rear side fuel tank cover.

**Tightening torque:**

**18 N·m (1.8 kgf·m, 13.0 ft·lb)**

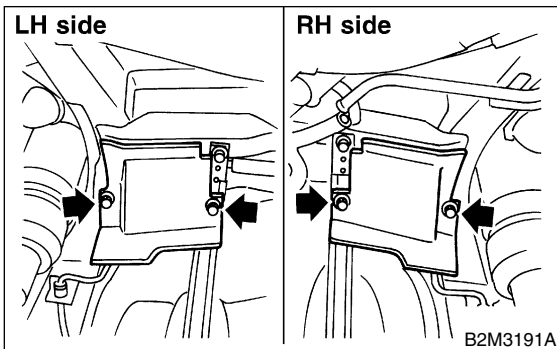

7) Install rear suspension assembly.

**WARNING:**

**A helper is required to perform this work.**

(1) Support rear suspension assembly and then tighten bolts which secure rear suspension assembly.

**Tightening torque:**

**T1: 172 N·m (17.5 kgf·m, 127 ft·lb)**

**T2: 108 N·m (11.0 kgf·m, 80 ft·lb)**

**T3: 66 N·m (6.7 kgf·m, 48 ft·lb)**

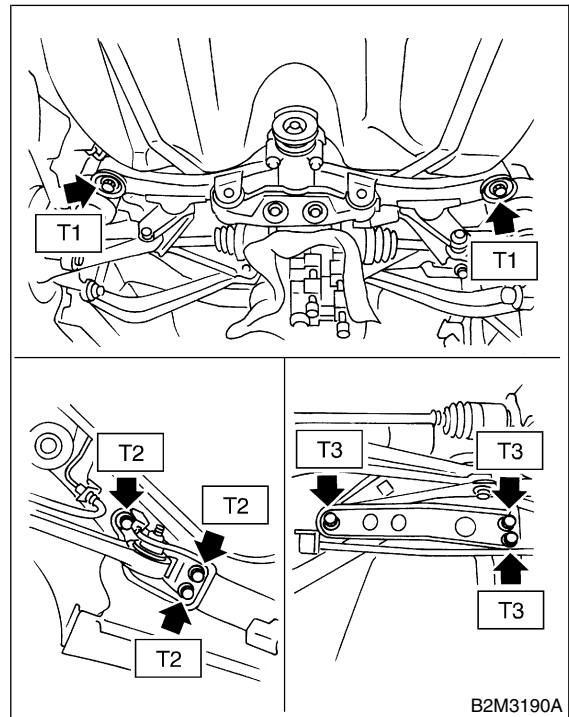

(2) Tighten bolt which holds rear shock absorber to rear suspension arm. <Ref. to RS-14, INSTALLATION, Link Upper.>

**Tightening torque:**

**157 N·m (16 kgf·m, 116 ft·lb)**

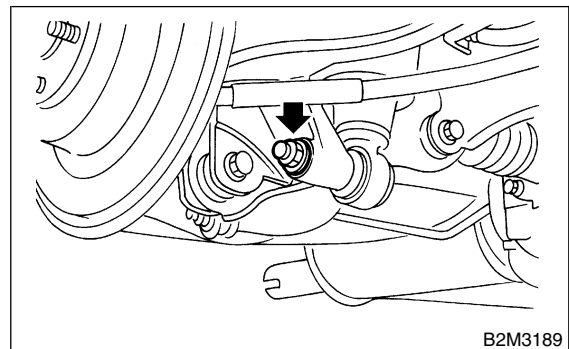

# FUEL TANK

## Fuel Injection (Fuel Systems)

8) Install rear brake caliper. <Ref. to BR-22, INSTALLATION, Rear Disc Brake Assembly.>

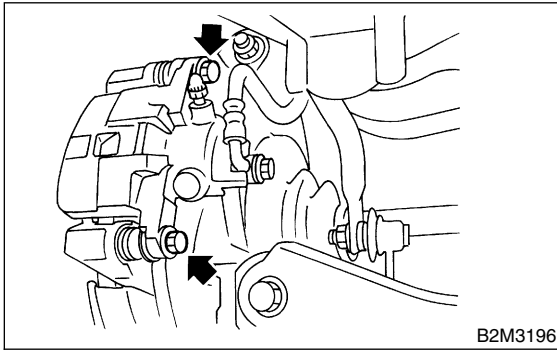

9) Tighten bolts which hold rear brake hoses holding bracket.

**Tightening torque:**

**33 N·m (3.4 kgf·m, 25 ft·lb)**

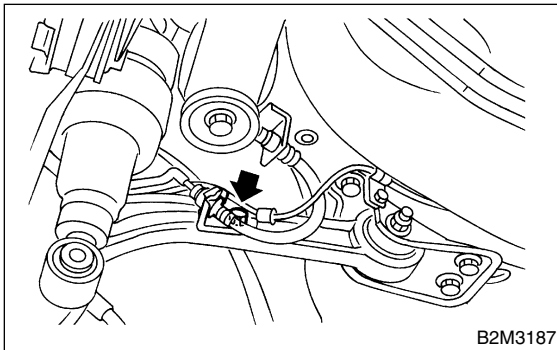

10) Install parking brake cable to cabin by forcibly pushing it forward.

11) Tighten bolts which hold parking brake cable holding bracket.

**Tightening torque:**

**18 N·m (1.8 kgf·m, 13.0 ft·lb)**

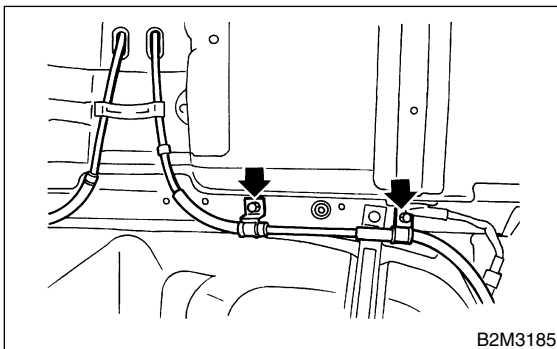

**Tightening torque:**

**32 N·m (3.3 kgf·m, 23.9 ft·lb)**

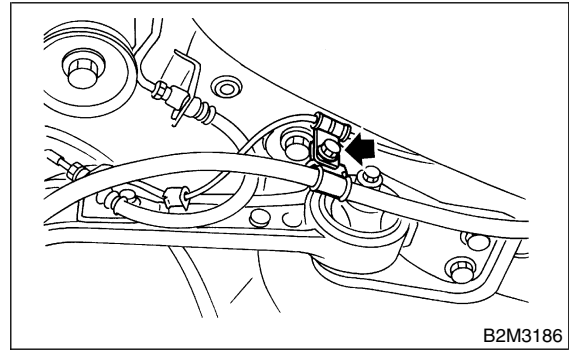

12) Connect connector to ABS sensor.

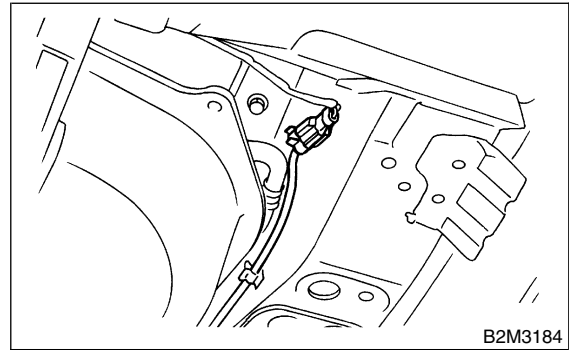

13) Install propeller shaft. <Ref. to DS-14, INSTALLATION, Propeller Shaft.>

14) Install rear exhaust pipe and muffler.

**NOTE:**

To facilitate the procedure, apply a coat of SUBARU CRC to matching area of rubber cushions in advance.

**SUBARU CRC (Part No. 004301003)**

(1) Install left and right rubber cushions.

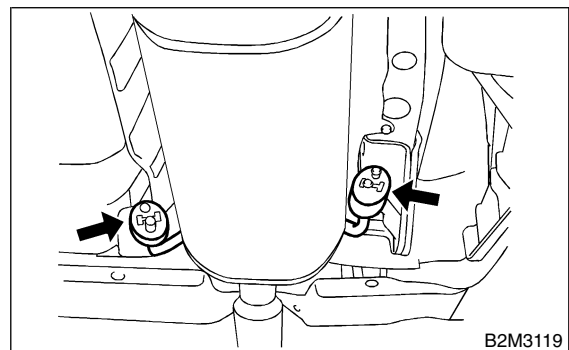

- (2) Install front rubber cushion and attach muffler assembly.

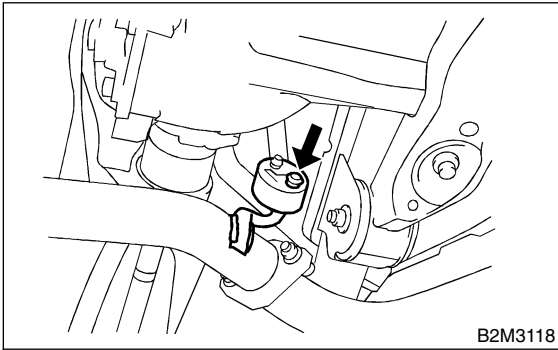

- (3) Install rear exhaust pipe to center exhaust pipe.

**Tightening torque:**

**18 N·m (1.8 kgf-m, 13.0 ft-lb)**

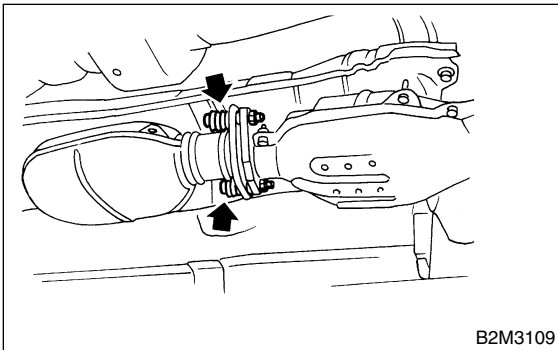

- 15) Install front side fuel tank cover.

**Tightening torque:**

**18 N·m (1.8 kgf-m, 13.0 ft-lb)**

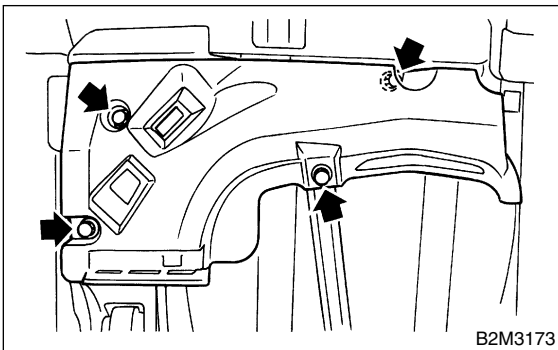

- 16) Install rear wheel.  
 17) Lower the vehicle.  
 18) Tighten wheel nuts to rear wheel.  
 19) Install parking brake cable. <Ref. to PB-4, INSTALLATION, Parking Brake Lever.>

- 20) Install console box. <Ref. to EI-36, INSTALLATION, Console Box.>

- 21) Connect fuel hoses and hold them with quick connector. <Ref. to FU-82, INSTALLATION, Fuel Delivery, Return and Evaporation Lines.>

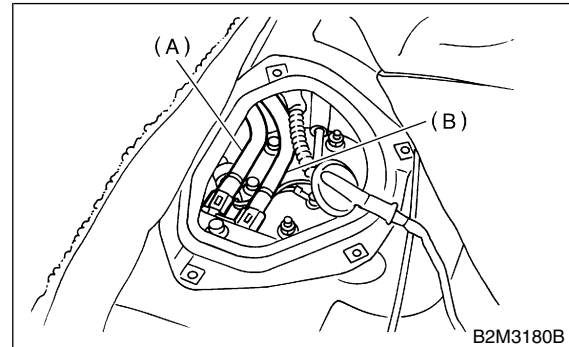

- (A) Delivery hose  
 (B) Return hose

- 22) Connect evaporation pipe and hold it with quick connector. <Ref. to FU-82, INSTALLATION, Fuel Delivery, Return and Evaporation Lines.>

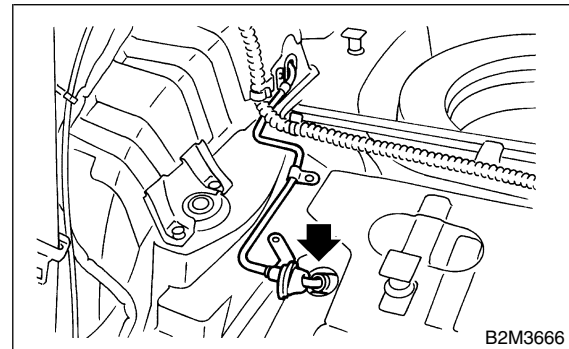

- 23) Install pipe protector.

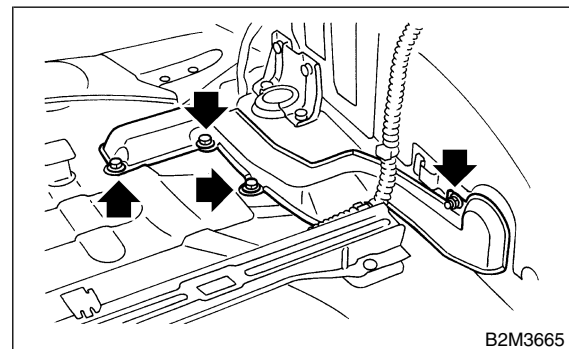

- 24) Install trunk room trim. (Sedan model)  
 25) Install luggage room trim. (Wagon model)

# FUEL TANK

## Fuel Injection (Fuel Systems)

26) Connect fuel jet pump hose.

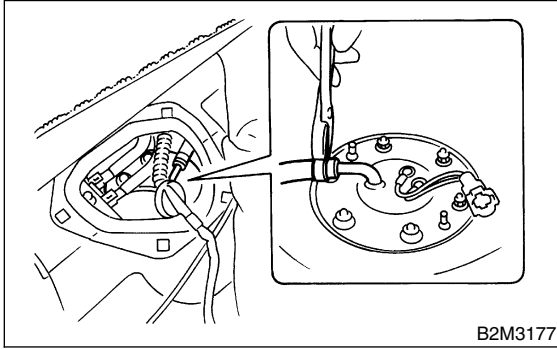

27) Connect connector to fuel sub level sensor.

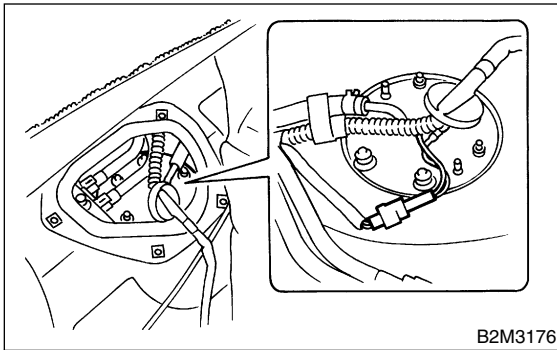

28) Install sub service hole cover.

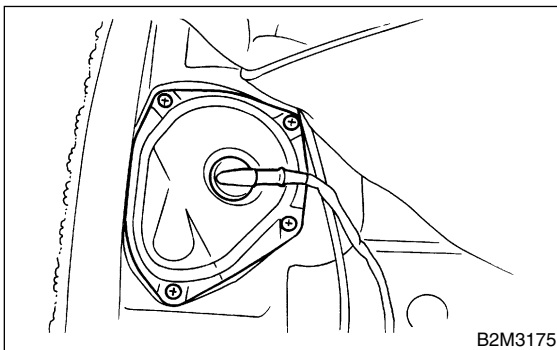

29) Connect connectors to fuel tank cord and plug service hole with grommet.

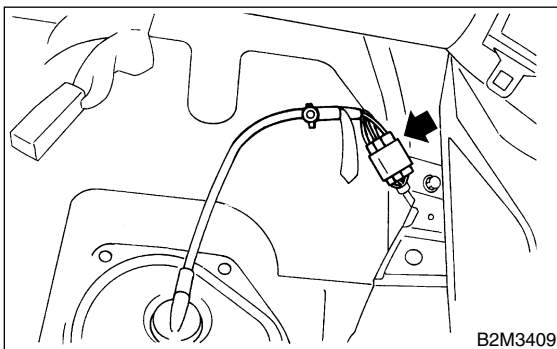

30) Install holder clip which secures fuel tank cord on bracket.

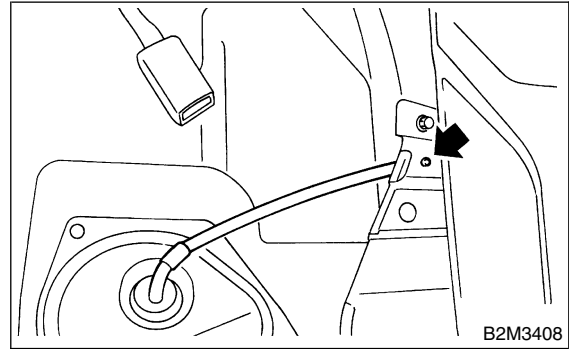

31) Set rear seat and floor mat.

32) Connect connector to fuel pump relay.

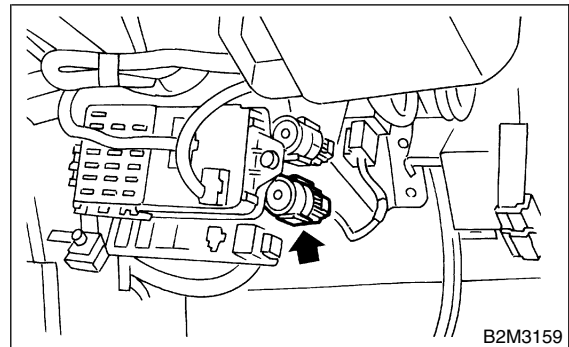

33) Bleed air from brake system. (Rear drum brake model only) <Ref. to BR-36, BRAKE LINE, PROCEDURE, Air Bleeding.>

34) Adjust parking brake lever stroke. <Ref. to PB-4, ADJUSTMENT, Parking Brake Lever.>

35) Check wheel alignment and adjust if necessary. <Ref. to FS-6, INSPECTION, Wheel Alignment.>

## C: INSPECTION S175053A10

1) Make sure there are no cracks, holes, or other damage on the fuel tank.

2) Make sure that the fuel hoses and fuel pipes are not cracked and that connections are tight.