

19. Fuel Pump Relay S145048

A: REMOVAL S145048A18

- 1) Disconnect battery ground cable.

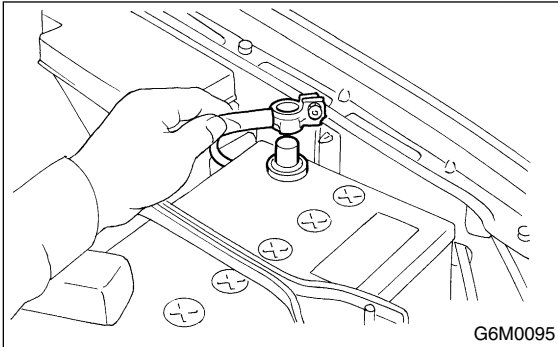

- 2) Remove lower cover. <Ref. to EI-37, REMOVAL, Instrument Panel Assembly.>
- 3) Disconnect connector from fuel pump relay.

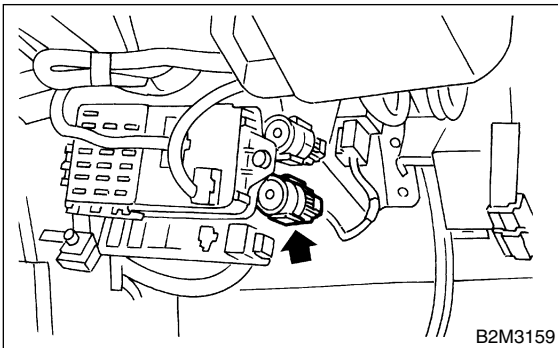

- 4) Remove fuel pump relay from mounting bracket.

B: INSTALLATION S145048A11

Install in the reverse order of removal.