

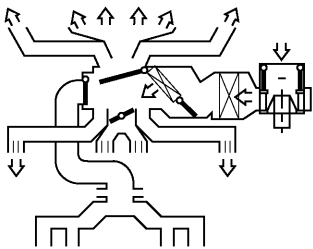





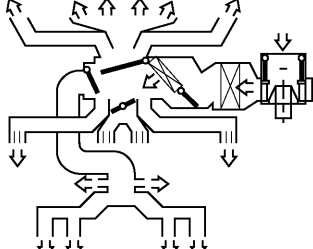

MODE SELECTOR SWITCH AND AIR FLOW

HVAC System (Heater, Ventilator and A/C)

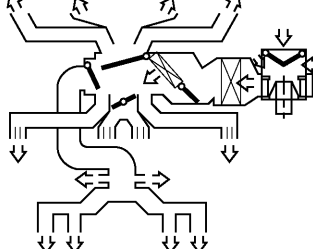
3. Mode Selector Switch and Air Flow

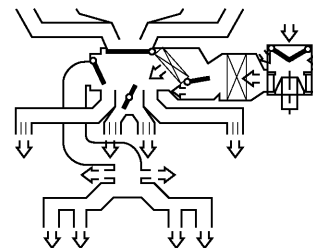
A: AIR FLOW

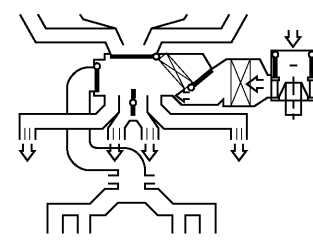
Mode selector switch position	Air flow
 DEF	
 DEF/HEAT	
 HEAT	
 BI-LEVEL	
 VENT	

B4H2241A

AC-4

MODE SELECTOR SWITCH AND AIR FLOW

HVAC System (Heater, Ventilator and A/C)

B: AIR DISTRIBUTION RATIO

The following diagram shows air distribution for each position of the mode selector switch.

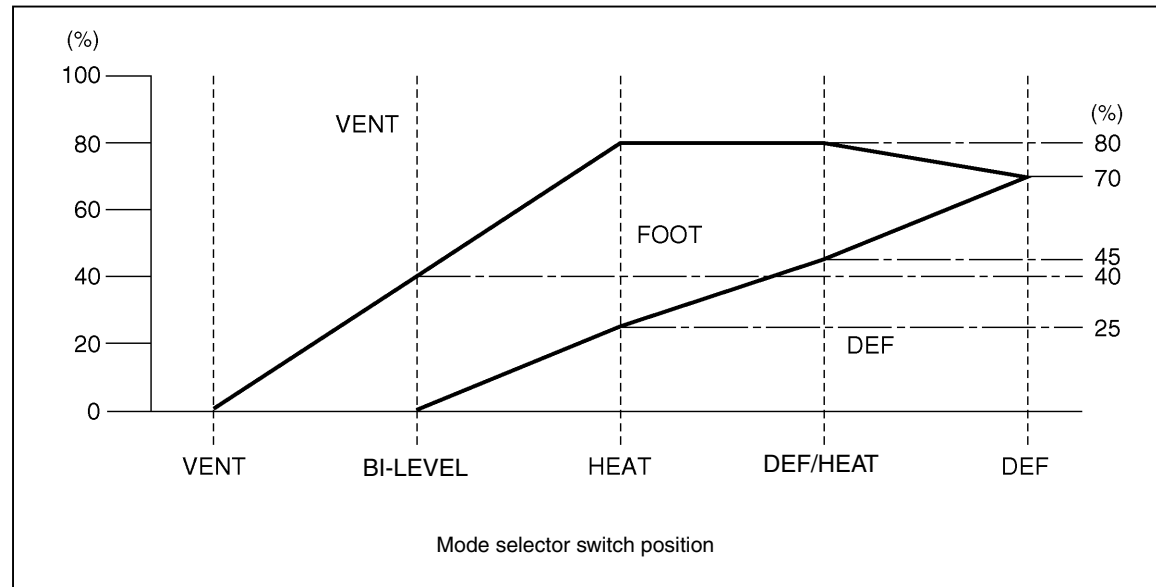

B4H1513C

C: SYSTEM CONTROL FLOW

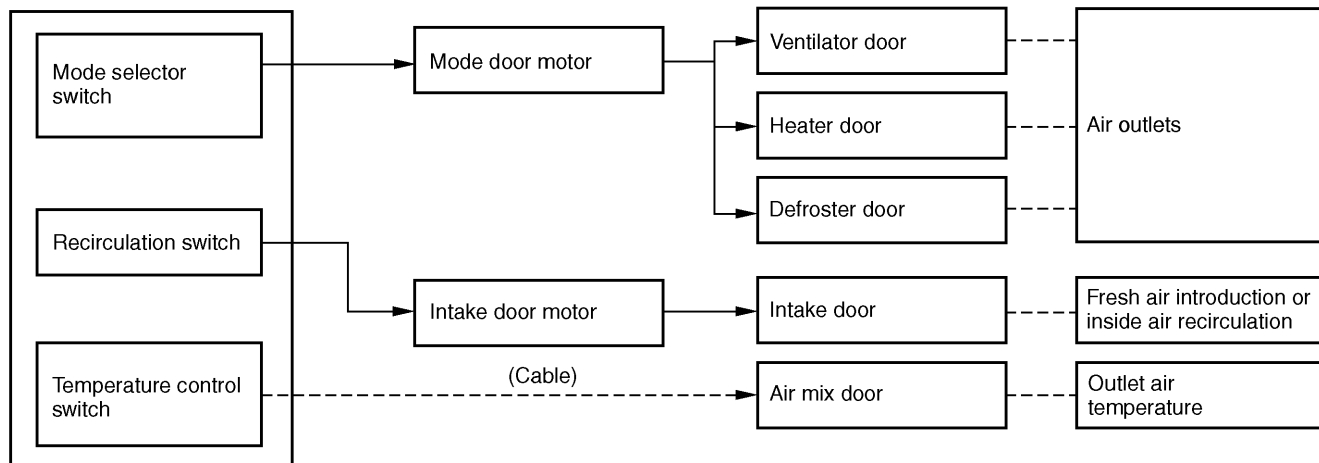

B4H0046B

AC-5