

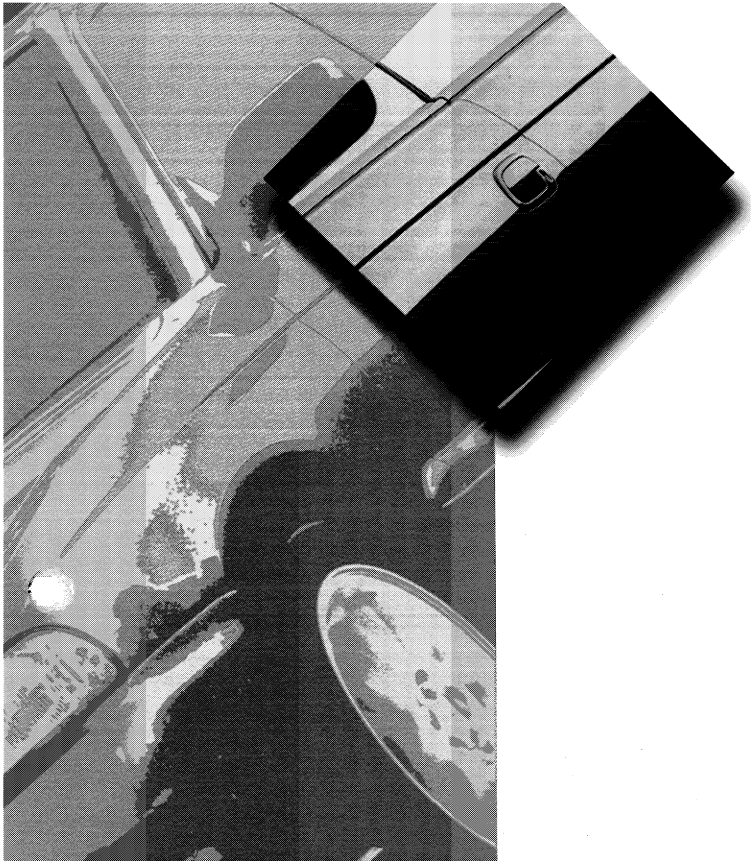

**An Introduction  
To Keyless Entry  
And  
Theft Deterrent  
Systems**



---

---

**Video Reference Booklet**

© Copyright 1997  
Subaru of America, Inc.

All rights reserved.  
This book may not be reproduced in whole  
or in part without the express written permission  
of Subaru of America, Inc.

Subaru of America, Inc. reserves the right at any time to make changes or modifications to systems, procedures, descriptions, and illustrations contained in this book without necessarily updating this document. Specifications included are accurate as they existed at the time of publication. Information herein is considered current as of December, 1997.

# AN INTRODUCTION TO KEYLESS ENTRY AND THEFT DETERRENT SYSTEMS

## CONTENTS

■	<b>INTRODUCTION</b> .....	<b>3</b>
	<b>SVX</b> .....	<b>4</b>
	Original SVX System (SOA386R120) .....	4
	Revised SVX System (SOA386R601) .....	5
	Front-Wheel Drive SVX System (SOA386R121) .....	5
	Dual Air Bag SVX System (SOA386R122) .....	5
■	<b>1990 - '94 LEGACY</b> .....	<b>6</b>
	Base System (SOA386R110) .....	6
	Mid-Level System (SOA386R111) .....	7
	High-Level System (SOA386R112) .....	8
	<b>1995 - '97 LSi</b> .....	<b>9</b>
	Theft Deterrent - Factory Installed .....	9
	Keyless Entry System .....	9
	<b>CODE ALARM SYSTEMS</b> .....	<b>10</b>
■	Keyless Entry System .....	10
	Security System Upgrade .....	10
	<b>INSTALLATION PROCEDURE - 1997 LEGACY</b>	
	<b>KEYLESS ENTRY SYSTEM</b> .....	<b>11</b>
	Installing the Keyless Entry Control Module .....	11
	Programming the Keyless Entry Control Module .....	13
	Testing the Remote Keyless Entry System .....	13
	<b>INSTALLATION PROCEDURE - 1997 LEGACY</b>	
■	<b>THEFT DETERRENT SYSTEM</b> .....	<b>14</b>
	Installing the Theft Deterrent System .....	14
	Testing the Theft Deterrent System .....	17
	Finishing the Installation Procedure .....	18
	<b>CONCLUSION</b> .....	<b>19</b>
■		
■		

# AN INTRODUCTION TO KEYLESS ENTRY AND THEFT DETERRENT SYSTEMS

## INTRODUCTION

This Video Reference Booklet accompanies the videotape "An Introduction to Keyless Entry and Theft Deterrent Systems." It summarizes the information contained in the videotape and includes additional information.

This Booklet provides an overview of the keyless entry and theft deterrent systems used on:

- The SVX
- The 1990 - '94 Legacy
- The 1995 - '97 LSi
- The Code Alarm System (used on the 1995 - '98 Legacy, the 1997 - '98 Impreza, and the 1998 Forester.)

It also demonstrates how to install the Code Alarm keyless entry and theft deterrent systems on a 1997 Legacy.

	Installation	Type	System Part No.	Theft Deterrent?	Keyless Entry?	Memory Retention?*
<b>SVX</b>						
Original	Port	Active/Passive <small>(no door locks with Passive)</small>	S0A386R120	Yes	Yes	No
Revised	Port/Dealer	Active	S0A386R601*	Yes	Yes	Yes
FWD	Port	Active	S0A386R121	Yes	Yes	Yes
Dual Air Bags	Port	Active	S0A386R122	Yes	Yes	Yes
<b>1990-'94 Legacy</b>						
Base Kit	Port/Dealer	Passive <small>(no door locks)</small>	S0A386R110	Yes	No	<small>(no transmitter)</small>
Wireless Remote Upgrade	Port/Dealer	Active/Passive	S0A386R111	Yes	No	No
Keyless Entry Upgrade	Port/Dealer	Active/Passive	S0A386R112	Yes	Yes	No
<b>1995-'97 LSi</b>						
Original Equipment	Factory	<small>(Armed when door locked)</small>	<small>(Factory installed)</small>	Yes	No	<small>(no transmitter)</small>
Keyless Entry Upgrade	Port/Dealer	Active	H 7110AS300 <small>(1995-'96)</small> H 7110AS500 <small>(1997)</small>	Yes	Yes	Yes
<b>1995-'98 Legacy</b>						
Keyless Entry	Port/Dealer	Active	H7110AS000 <small>(1995-'96)</small> H7110AS400 <small>(1997-'98)</small>	No	Yes	Yes
Security System Upgrade	Port/Dealer	Active	H 7110AS600 <small>(1997-'98)</small>	Yes	Yes	Yes
<b>1997 Impreza</b>						
Keyless Entry	Port/Dealer	Active	H7110FS000	No	Yes	Yes
<b>1998 Impreza</b>						
Keyless Entry	Port/Dealer	Active	H7110FS001	No	Yes	Yes
Security System Upgrade	Port/Dealer	Active	H7110FS200	Yes	Yes	Yes
<b>1998 Forester</b>						
Keyless Entry	Port/Dealer	Active	H7110FS100	No	Yes	Yes
Security System Upgrade	Port/Dealer	Active	H7110FS200	Yes	Yes	Yes

With Power Door Locks Only

\* Switch and Control Module Only

\*\* "No" indicates transmitter frequency not retained in memory after vehicle battery power is disconnected

"Yes" indicates transmitter frequency retained in memory after vehicle battery power is disconnected

# AN INTRODUCTION TO KEYLESS ENTRY AND THEFT DETERRENT SYSTEMS

## SVX

All SVX's sold in the U.S. are equipped with a theft deterrent system installed at the port.

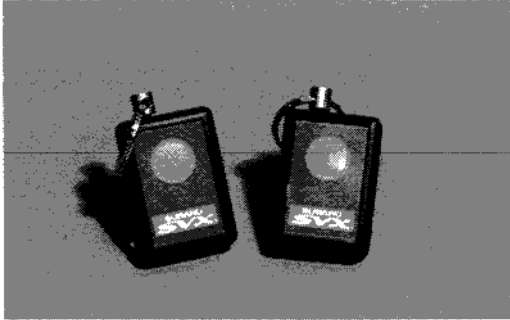

**SVX Transmitters**

### Original SVX System (SOA386R120)

The first version is SOA386R120, designed for all-wheel drive SVX vehicles with a single driver's side air bag. It's a combination active and passive system. When the system is on and the doors and trunk are closed, the driver can actively lock the doors and arm the system by pressing the button on the remote transmitter.

The security system also passively arms itself when it's on, 45 seconds after the driver exits from the vehicle and closes the doors and trunk lid. Note: the doors do not have to be locked.

When the security system is Off, the transmitter operates the keyless entry system only.

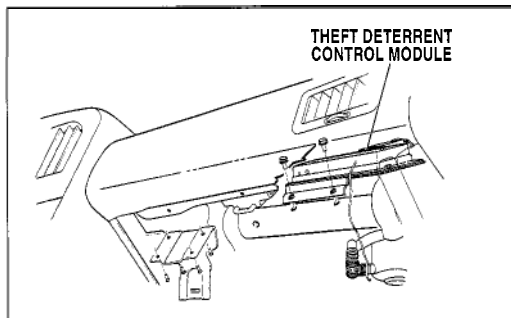

**SVX Theft Deterrent Control Module**

The components include the theft deterrent control module, located behind and above the glove box, and a starter interrupt relay, mounted on the right of the steering column.

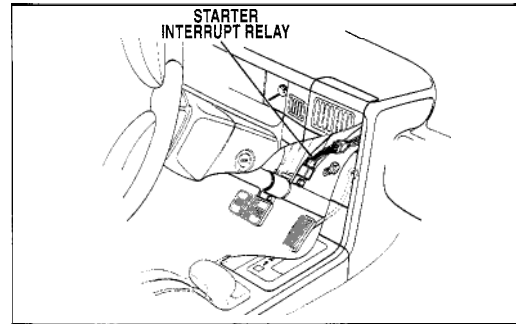

**SVX Starter Interrupt Relay**

The original SVX theft deterrent system needs to be reprogrammed for the remote transmitters any time vehicle battery power is lost, for example when the battery is disconnected. When the vehicle's battery is reconnected, the parking lights flash and the theft deterrent control module clicks, to indicate that the system needs to be reprogrammed.

To reprogram the system, press the button on one transmitter two times (while the parking lights are flashing), then press the other transmitter button twice, then press the button on the first transmitter once more - a total of five times. The system responds by turning on the parking lights each time the button is pressed. While the button is being pressed, the lights stay on and do not flash.

Pressing the transmitters five times fills up all five memory slots in the theft deterrent control module.

One unique feature of the original SVX system is that the system is On when the security button is out, and Off when the button is pushed in.



**SVX Security Switch**

# AN INTRODUCTION TO KEYLESS ENTRY AND THEFT DETERRENT SYSTEMS

## Revised SVX System (SOA386R601)

In 1992 1/2, the SVX theft deterrent system was revised to make the system more user friendly. In the revised system, the passive-arming feature is eliminated. The only way to arm the system is to press the button on the remote transmitters, or lock the driver's door with a key or with the inside door lock.

Customers whose SVX's had the original theft deterrent system were invited to have the system upgraded by the dealer. The upgraded system includes a control module and a security system switch.

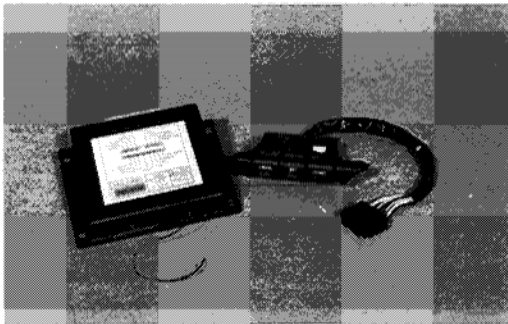

**SVX Theft Deterrent Control Module and Security System Switch, SOA386R601**

This control module has a permanent memory, so the system only needs to be reprogrammed for a new transmitter - not when the vehicle battery has been disconnected. To reprogram this system, turn the security system "Off." Put the key in the ignition switch and turn the ignition switch "On" then "Off," two times. Then immediately push the security switch on and off rapidly until the horn starts to beep. Slowly press the button two times on each transmitter. The control module has four memory slots, not five.

The parking lights flash each time a transmitter button is pushed, to indicate that the security system has recorded the transmitter frequency. Now cycle the ignition switch "On" then "Off" to exit from the programming mode.

The new security system switch is a momentary-contact type. It blinks when the system is on, and is dark when the system is off.

## Front-Wheel Drive SVX System (SOA386R121)

In 1994, a version of the SVX was introduced that was front-wheel drive; a different theft deterrent system was used on this vehicle. Front-wheel drive SVX's with a single air bag use the theft deterrent system SOA386R121.

## Dual Air Bag SVX System (SOA386R122)

In 1994, dual air bags became optional on the SVX. On these vehicles, the theft deterrent control module was moved to the underside of the rear shelf. The theft deterrent system for SVX's with dual air bags is SOA386R122.

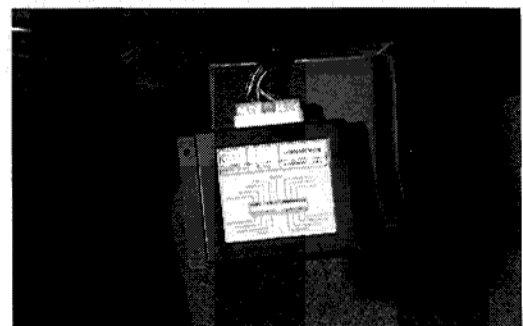

**Location of Theft Deterrent Control Module - SVX with Dual Air Bags**

# AN INTRODUCTION TO KEYLESS ENTRY AND THEFT DETERRENT SYSTEMS

## 1990 - '94 LEGACY

This vehicle has three levels of theft deterrent systems, all of which are port- or dealer-installed options.

### Base System (SOA386R110)

The base system, SOA386R110, is passive only; it does not have a remote transmitter. When the system is on and all the doors are closed, the system arms itself after 25 seconds. The doors do not have to be locked for the system to arm.

The base security system includes a control module mounted on the steering column, and a valet switch/LED mounted on the dash to the left of the steering column.

The security system switch has three positions: "Off," "Shock Off," and "On." In the "Shock Off" position, the security system is on, but the shock sensor is disabled; the theft deterrent system will sound the horn and flash the parking lights only when unauthorized entry or tampering occurs.

When the switch is in the "On" position, the theft deterrent system will also activate when an impact is detected. If the impact is moderate, the system will activate the alarm for two seconds to "warn away" an intruder. If the impact occurs three times within seven seconds, or if the impact is extreme, the alarm will activate for two minutes.

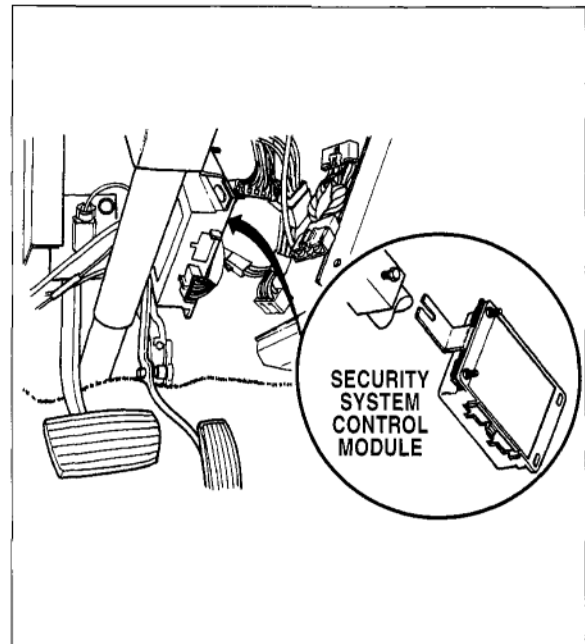

Theft Deterrent Control Module - 1990-'94 Legacy

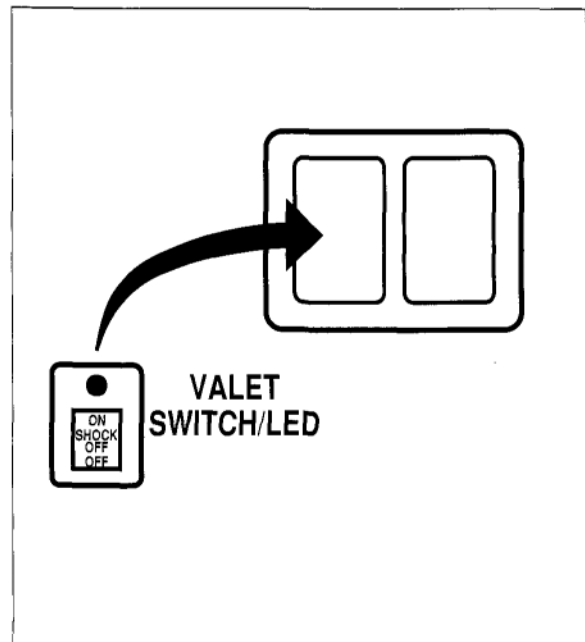

Valet Switch - 1990-'94 Legacy

# AN INTRODUCTION TO KEYLESS ENTRY AND THEFT DETERRENT SYSTEMS

## Mid-Level System (SOA386R111)

For the next level of theft deterrent, SOA386R111, which is added to 110, the theft deterrent system can be actively armed and disarmed using the remote transmitters. It also passively arms itself when all doors are closed. Note that the transmitters only arm and disarm the theft deterrent system - they do not lock or unlock the doors.

In addition to the base system components, the mid-level system includes a receiver and remote transmitters to arm and disarm the system.

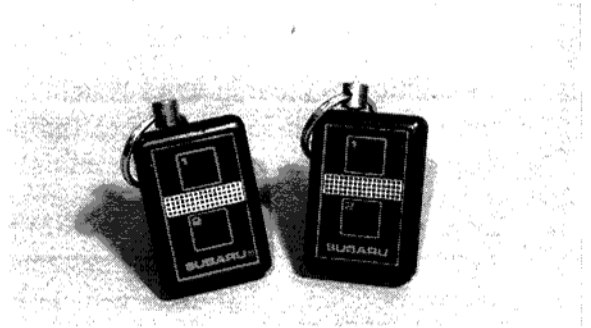

Remote Transmitters (1990-'94 Legacy with Remote Theft Deterrent)

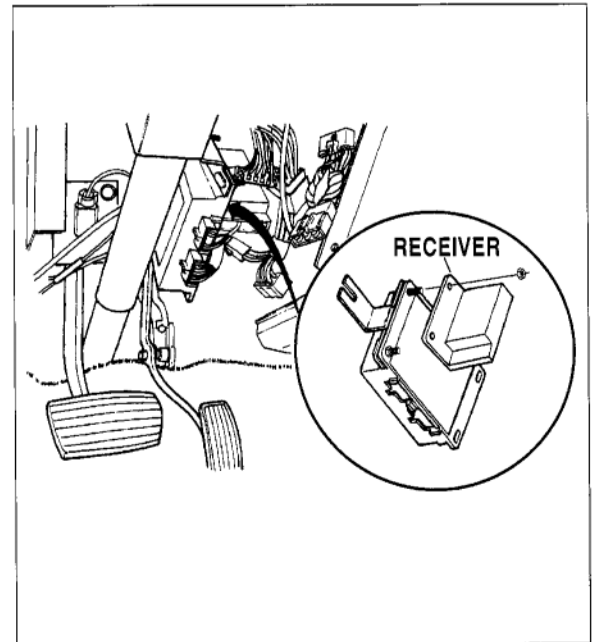

Receiver Module - 1990-'94 Legacy



# AN INTRODUCTION TO KEYLESS ENTRY AND THEFT DETERRENT SYSTEMS

## High-Level System (SOA386R112)

The highest level of theft deterrent, SOA386R112, is added to 110 and 111. It provides keyless entry in addition to theft deterrent. The remote transmitters lock and unlock the doors as well as arming and disarming the theft deterrent system.

In addition to the mid-level system components, the high-level system includes a door lock actuator as well as a module.

Like the earliest SVX, the mid-level and high-level 1990 - '94 Legacy systems must be reprogrammed any time vehicle battery power is lost.

When vehicle battery power is restored, the parking lights flash at one second intervals to indicate the system is ready to be reprogrammed.

To reprogram the system, press button one on one transmitter, and hold it for two seconds, then button two, then both buttons simultaneously. Then press button one on the other transmitter, then button two. Be sure to hold each button down for two seconds. Pressing the buttons in this sequence fills all five memory slots in the theft deterrent control module.

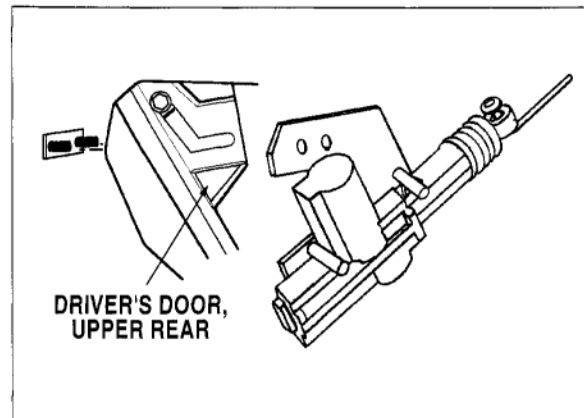

Door Lock Actuator - 1990-'94 Legacy

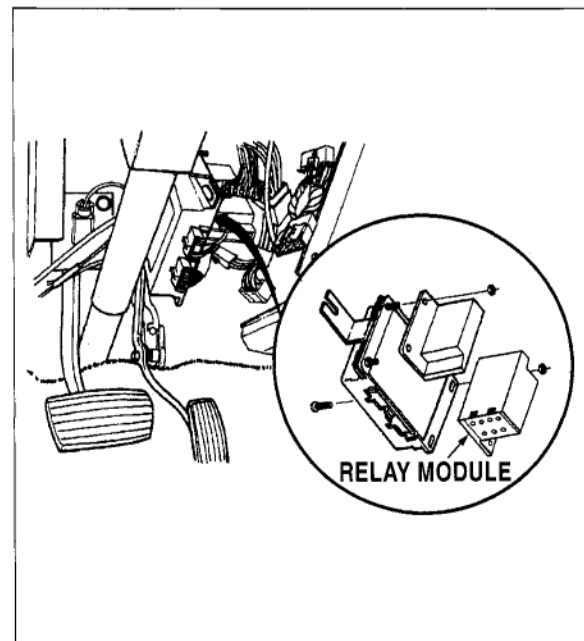

Keyless Entry Control Module - 1990-'94 Legacy

# AN INTRODUCTION TO KEYLESS ENTRY AND THEFT DETERRENT SYSTEMS

## 1995 - '97 LSi

### Theft Deterrent

All 1995 - '97 LSi's sold in the U.S. are equipped with a factory-installed theft deterrent system. The system arms itself when the driver exits from the vehicle and locks the doors with a key, or when the driver locks the door with the door lock.

The system includes a theft deterrent control module and a security system indicator LED. The LED is on steadily when the system is armed.

### Keyless Entry System

The 1995 - '97 LSi has a port- or dealer-installed optional keyless entry system manufactured by Code Alarm. The Code Alarm control module remembers the frequencies of the transmitters, after vehicle battery power has been disconnected. When battery power is restored, it may flash the parking lights, to ask whether the transmitters have changed. If it does, press the Lock button on the transmitter once, to indicate that the transmitters have not changed.

To reprogram this system for new transmitters, with the ignition switch "On," press and hold the programming button. After 15 seconds the door locks should cycle (or, on some vehicles, the relay in the control module will click). Continue pressing the programming button.

With your other hand, press the Lock button on one of the transmitters, twice, then press the Lock button on the other transmitter twice. This will fill up the four memory slots in the theft deterrent control module with the frequencies of the two transmitters.

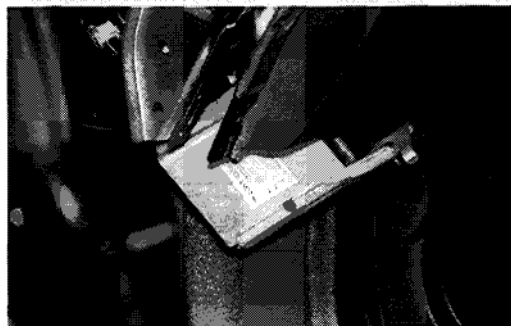

Theft Deterrent Control Module - 1995-'97 LSi



Security System Indicator (LED) -  
1995-'97 LSi

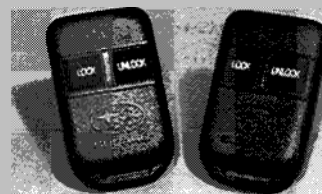

Remote Transmitter - 1995-'97 LSi with  
Keyless Entry



Programming button - 1995-'97 LSi

# AN INTRODUCTION TO KEYLESS ENTRY AND THEFT DETERRENT SYSTEMS

## CODE ALARM SYSTEMS

The Code Alarm systems are port- or dealer-installed options. They are used on the 1995 - '98 Legacy, the 1997 - '98 Impreza, and the 1998 Forester.

The base system provides keyless entry; theft deterrent is an upgrade. There are different kits for different carlines; see the *Keyless Entry and Vehicle Security Systems Installation Reference Guide* for details.

### Keyless Entry System

The keyless entry system kit has a control module, two remote transmitters, and a harness.

For the 1997 Impreza, the keyless entry system kit includes a door lock actuator, since the driver's door does not come equipped with an electric actuator.

### Security System Upgrade

The security system upgrade kit includes a shock sensor, a siren, a valet button and LED indicator and additional harnesses. It's an active system - it can be armed only with the transmitters.



1997-'98 Legacy Keyless Entry  
Kit, Code Alarm H7110AS400



1997 Impreza Keyless Entry  
Kit, Code Alarm H7110FS000

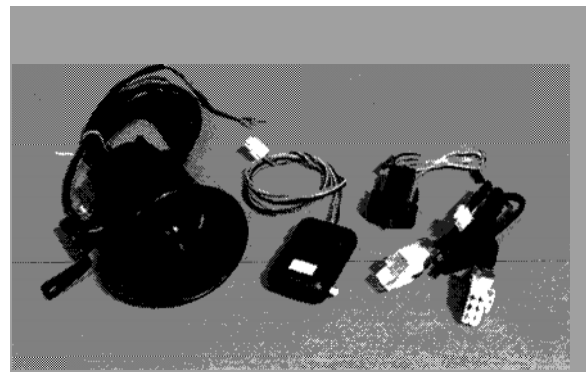

1997-'98 Legacy Security System  
Kit, Code Alarm H7110AS600

# AN INTRODUCTION TO KEYLESS ENTRY AND THEFT DETERRENT SYSTEMS

## INSTALLATION PROCEDURE - 1997 LEGACY KEYLESS ENTRY SYSTEM

Installation on the 1997 and '98 Impreza and 1998 Forester is much easier because the vehicles are pre-wired for the Code Alarm system - all you have to do is plug in the wire connectors. With the 1995 to 1997 Legacy and some 1998 Legacys, you will have to splice some wires.

### Installing the Keyless Entry Control Module

Whenever working on a keyless entry system, be sure to lower the driver's side window, so you don't accidentally lock the keys in the vehicle. Remove the driver's side rocker/kick panel molding, and remove the lower left dash trim to access the wiring.

Plug the wiring harness into the remote keyless entry module and remove the 20-amp fuse from the yellow wire with a green trace.

To connect the module to battery power and switched power, first locate the gray 12-pin connector B-52 in the fuse box.

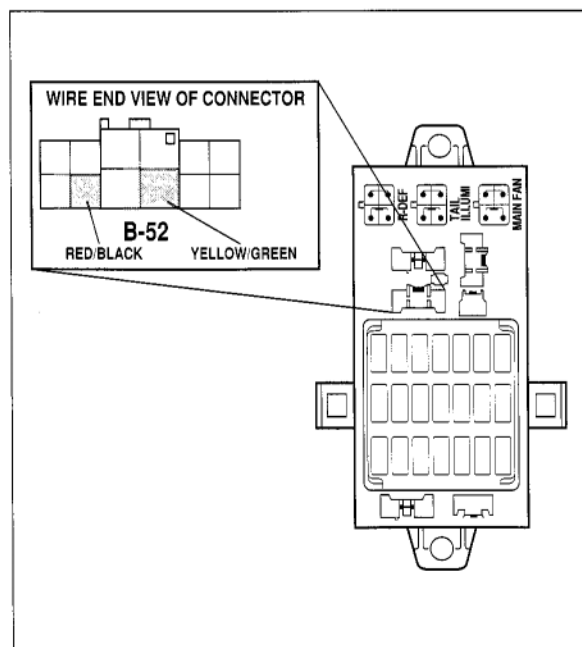

Fuse Box Connector B-52

In most cases, the keyless entry module's wire colors match the colors of the vehicle's wires that they splice with. But be careful to connect the wires correctly - mistakes are easy to make, and the system won't work if the connections are wrong!



Using a Quick-Splice Connector

Using one of the red quick-splice connectors supplied in the keyless entry kit, connect the module's yellow/green wire to the vehicle's yellow/green

wire, which provides constant power. Put the quick-splice connector on the module's wire first, using pliers to make sure the connector cuts through the insulation. Then attach the quick splice connector on the vehicle's yellow/green wire, approximately 1 in. from the vehicle connector. Wrap the splice with electrician's tape to secure it.

Splice the module's red/black wire to the vehicle's red/black wire, which provides switched power; this splice should also be made 1 in. from the vehicle connector. Note: there are two red/black wires; be sure to splice to the correct one!

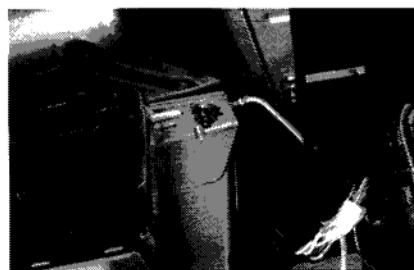

Module's White Wire Connected to Ground

Next, connect the module's white wire to ground. Use the stud holding the door lock timer on the left side of the steering column.

# AN INTRODUCTION TO KEYLESS ENTRY AND THEFT DETERRENT SYSTEMS

Now connect the module to the parking lights. Locate the gray 15-pin connector, I-5 in the fuse box. Using a quick-splice connector, connect the module's white/yellow wire to the vehicle's white/yellow wire, 1 in. from the vehicle connector.

Now, connect the module to the courtesy lights. Locate the black 22-pin connector B-36 above the hood lock release lever and unplug it. Splice the module's red/white wire to the vehicle's red/white wire, 1 in. from the connector, and plug the connector back into the connector block.

Now, connect the module to the door locks. Locate the 8-pin connector B-92 plugged into the door lock timer. Splice the module's white/red wire to the vehicle's white/red wire, 1 in. from the connector. Splice the module's white wire to the vehicle's white wire, 1 in. from the connector.

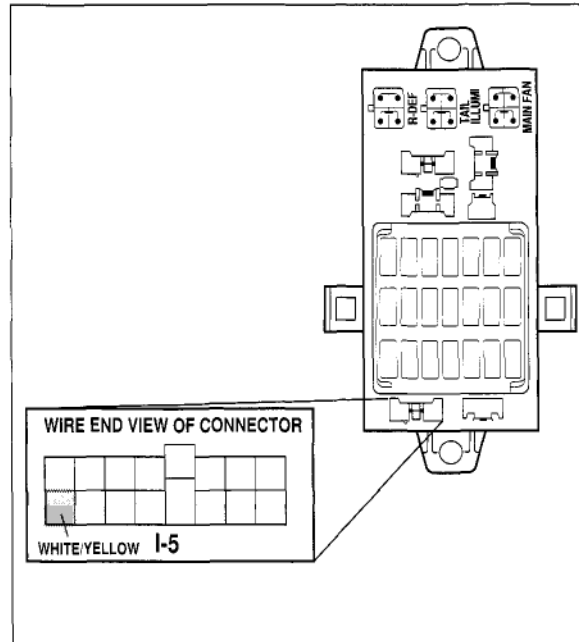

Fuse Box Connector I-5

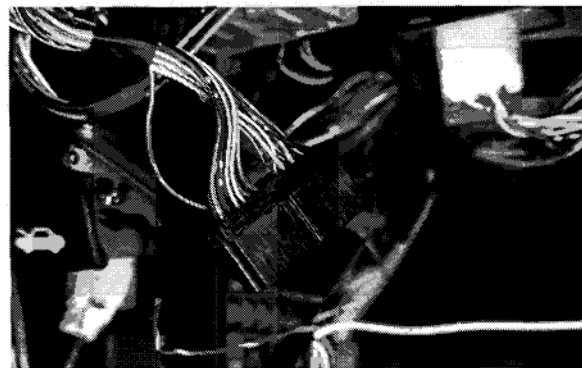

Connector B-36



Connector B-92

# AN INTRODUCTION TO KEYLESS ENTRY AND THEFT DETERRENT SYSTEMS

Locate the 2-pin in-line connector D-8 below the fuse box. Cut the red/green wire a little more than 1 in. from the connector. Butt-splice the red/green wire on the driver's door side of the cut to the module's red/green wire. Make sure the correct wires are

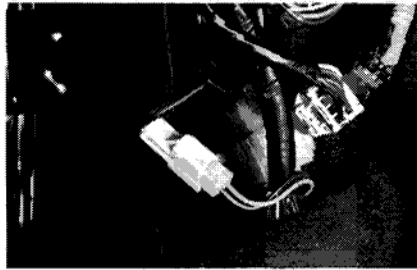

Connector D-8

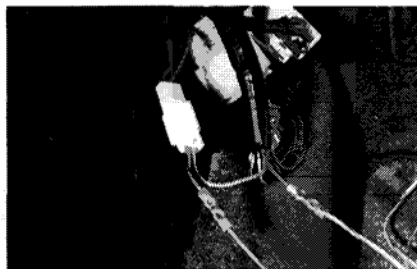

Butt-Splicing Red/Green Wire on Module to Vehicle's Red/Green Wire and Pink/Green Wire to Vehicle's Red/Green Wire

butt-spliced together or the keyless entry module or the door lock control module may be damaged, or the door lock fuse may be blown. Butt-splice the red/green wire on the vehicle interior side of the cut to the module's pink/green wire. Use electrician's tape to secure the butt splices.

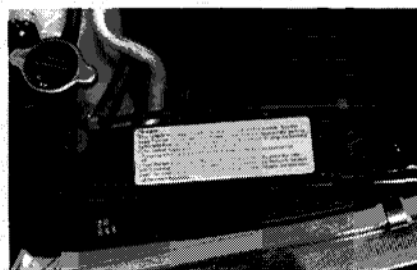

Label on Radiator Support

Attach the label with large lettering to the radiator support, and the label with small lettering to the negative battery cable.

## Programming the Keyless Entry Control Module

Once the keyless entry control module is installed, you will need to program it to

receive the transmitter frequencies. With the ignition switch "On" and the engine not running, insert the 20-amp fuse in the holder on the yellow/green wire.

With the driver's door open, press and hold the programming button on the wiring harness.

After 15 seconds, the door locks will cycle to indicate the system is in the programming mode. Do not release the programming button. Press the "Lock" button twice on one of the transmitters. The door lock actuators will operate each time a button is pressed to confirm programming. Repeat this step for the other transmitter. Then release the programming button and turn the ignition switch "Off."

## Testing the Remote Keyless Entry System

To test the keyless entry system, first close all vehicle doors; the dome light switch should be set to the "Door" position.

Press the Lock button on one of the remote transmitters. The vehicle doors should all lock, the courtesy light should turn off, and the parking lights should flash once.

Press the Unlock button on one of the transmitters. The driver's door should unlock, the courtesy lights should turn on, and the parking lights should flash once.

Press and hold the Unlock button on the same transmitter. The other doors should unlock.

Now, repeat the procedure with the other transmitter.

If the keyless entry system responds incorrectly, check the installation.

# AN INTRODUCTION TO KEYLESS ENTRY AND THEFT DETERRENT SYSTEMS

## INSTALLATION PROCEDURE - 1997 LEGACY THEFT DETERRENT SYSTEM

Once the Code Alarm keyless entry system has been installed, the theft deterrent system can be added. Begin by removing both 20-amp fuses from the keyless entry wire harness and unplugging the harness wire connectors from the keyless entry control module.

Adding the theft deterrent system does not require a second control module; the electronic controls for the system are already in the keyless entry module. The additional components required are the shock sensor, the siren, the starter interrupt harness, the valet button/LED indicator, and the dome lamp wire loop.

### Installing the Theft Deterrent System

Install the siren on the passenger side shock tower, using the existing 10 mm bolt. The bell housing should face downward and should not touch any other components.

On newer models, the bell housing of the siren may contact the A/C line. If it does, carefully reposition the A/C line. Be sure to wear appropriate safety equipment when performing this procedure. Tape the ends of the siren wiring harness to prevent damage to the tips when the harness is being installed.

Route the siren wires under the brake proportioning valve to the harness grommet on the driver's side bulkhead.

Remove the grommet from the access hole and pierce it. Thread the siren wires through the grommet. Pierce the bulkhead insulation and pass the siren wires through the bulkhead panel and into the passenger compartment. Reinstall the grommet. Apply silicone to seal the grommet.

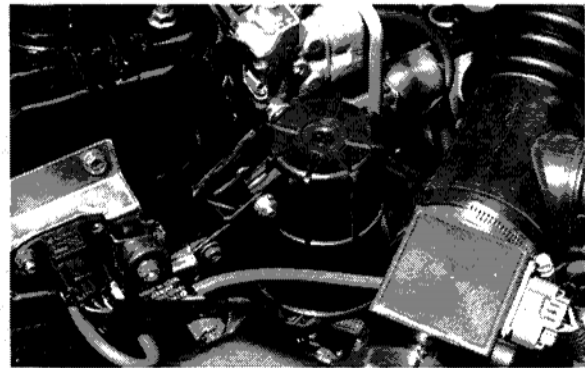

Siren

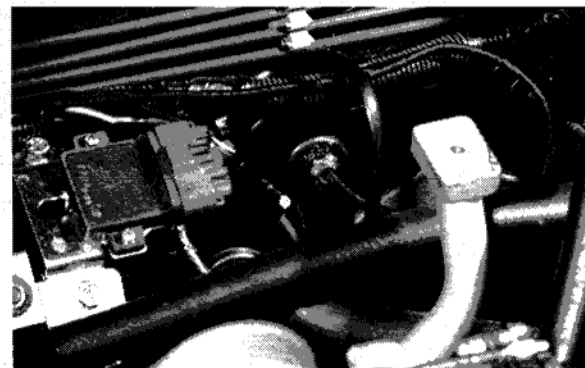

Harness Grommet - Driver's Side Bulkhead

# AN INTRODUCTION TO KEYLESS ENTRY AND THEFT DETERRENT SYSTEMS

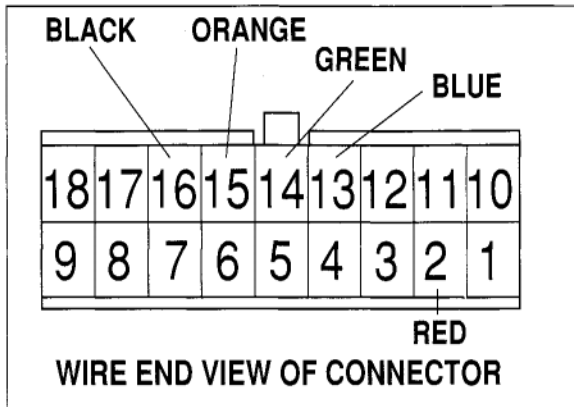

**18-Pin Keyless Entry Control Module Connector**

Plug the red wire from the siren into the wire side of cavity 2 of the 18-pin keyless entry control module connector and the black wire into cavity 16. Next, install the starter interrupt harness. Unplug the black 6-pin vehicle ignition connector B-72 to the right of the steering column, and plug the starter interrupt harness into both connectors of the harness.



**Starter Interrupt Harness Connected into Vehicle Ignition Connector, B-72**

Route the free end of the starter interrupt harness to the keyless entry module and plug the 2-pin connector from the harness into the 2-pin receptacle in the keyless entry module. Secure the harness with tie-wraps.

Now install the valet button and LED indicator. Using a small screwdriver, remove the dash blank, being careful not to damage the instrument cluster bezel, and install the valet button and LED indicator to the left of the steering wheel.

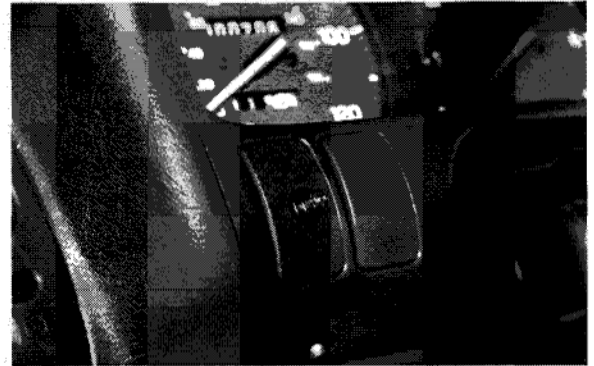

**Valet Button/LED Indicator**

Route the wires to the keyless entry module and plug the wires into the wire end side of the 18-cavity connector. The blue wire goes in cavity 13, the green wire in cavity 14, and the orange wire in cavity 15.

Next unravel the wire to the programming button on the keyless entry harness. Insert the button in the square hole in the metal bracket behind the hood release lever. Use the button housing to secure it.

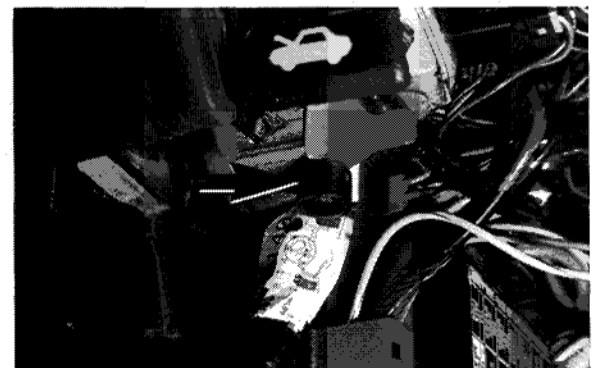

**Programming Button Inserted into Metal Bracket Behind Hood Release Lever**



# AN INTRODUCTION TO KEYLESS ENTRY AND THEFT DETERRENT SYSTEMS

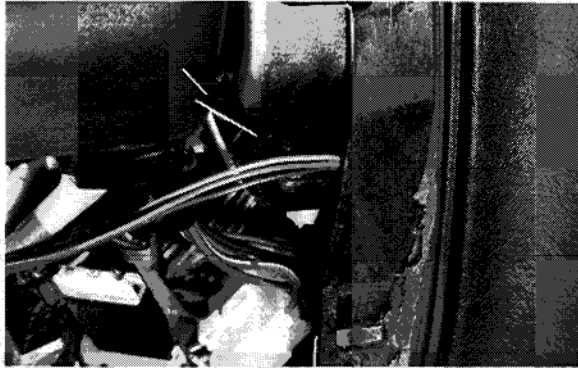

**Shock Sensor Attached to Metal  
Bracket on Right of Steering Column**

Stick the self-adhesive pad on the back of the shock sensor housing. Attach the shock sensor to the metal bracket on the right side of the steering column. The sensor should be mounted with the side labeled “Sensor” facing downwards, and the harness end pointing toward the rear of the vehicle. Secure the sensor with a tie wrap. Plug the 4-pin shock sensor connector into the 4-pin receptacle on the keyless entry module.

Next, remove the 2-pin jumper for the dome lamp wire loop on the keyless entry harness and discard it. Plug the dome lamp wire loop supplied in the kit into both connectors on the harness.

Plug the 18-pin and 5-pin connectors into the keyless entry module.

With the ignition switch “On,” insert both 20-amp fuses into the keyless entry harness and turn the ignition switch “Off.” Be sure to do this as the last step, before testing the system.



**Connecting 4-Pin Shock Sensor  
into Keyless Entry Module**



**Dome Lamp Wire Loop (Connected)**

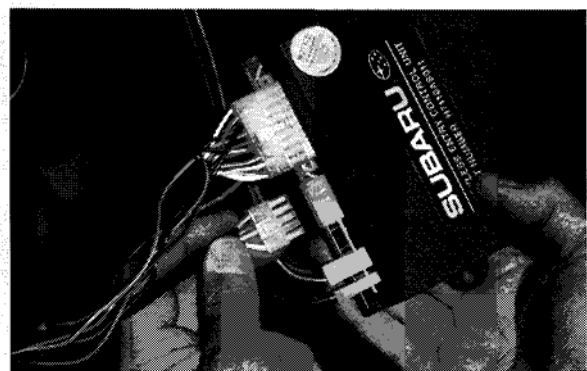

**Connecting 18-Pin and 5-Pin Connectors  
into Keyless Entry Module**

# AN INTRODUCTION TO KEYLESS ENTRY AND THEFT DETERRENT SYSTEMS

## Testing the Theft Deterrent System

Exit from the vehicle and close all the doors.

Press the Lock button on the remote transmitter. The doors should lock; if they don't check the door lock connections. The siren should "chirp" twice and the parking lamps should flash twice. If they don't make sure all doors are closed.

The status indicator should flash at a steady rate (about once per second). If it doesn't, but the siren chirps twice, check the indicator connections. If the status indicator does not flash and the siren does not chirp, make sure all doors are closed.

Open the vehicle door. The siren should sound and the parking lights should flash. If they don't, check the dome light connections. Also, the status indicator should flash quickly.

With the alarm sounding, try starting the engine; the engine should not start. If it does, make sure the emergency override (programming) button is not pressed in.

Press the Unlock button on the transmitter to disarm the system. Attempt to start the engine. The siren and parking lights should stop, the driver's door should unlock, and the engine should start. If not, check the ignition switch connections.

Press both the Lock and Unlock buttons simultaneously. The panic alarm should sound. Press either button to turn it off.

With the ignition switch Off, press and release the status indicator/valet button. The indicator should begin flashing in a quick double-flash pattern (valet mode). Pressing the transmitter buttons will lock and unlock the doors, with the siren and the parking lights emitting one pulse, but the system will not arm. Press the valet button again to exit from the valet mode.

Close all the doors. With the driver's window down, arm the system and wait 10 seconds. Reach inside the vehicle and hit the rim of the steering wheel firmly. (Do not hit the horn or the air bag!) The alarm should sound. Press the Unlock button to stop the alarm. If it does not sound, adjust the sensitivity of the shock sensor (See the *Keyless Entry and Vehicle Security Systems Installation Reference Guide* for the procedure.)

Close all the doors. With the driver's window down, arm the system and wait 10 seconds. Then trigger the system by opening a door, from inside, by reaching into the vehicle. The siren should sound. Turn the ignition switch to the On position, then press the emergency override button. The alarm will shut off. If the siren does not sound, or does not go off when the emergency override button is pushed, check the button and wiring.

# AN INTRODUCTION TO KEYLESS ENTRY AND THEFT DETERRENT SYSTEMS

## Finishing the Installation Procedure

Once the system has been completely tested, mount the keyless entry module with the connectors facing upward in the area above the fuse box, and secure it with tie wraps.

Put the window decals on the inside of the rear passenger windows at the lower front edge of each window.

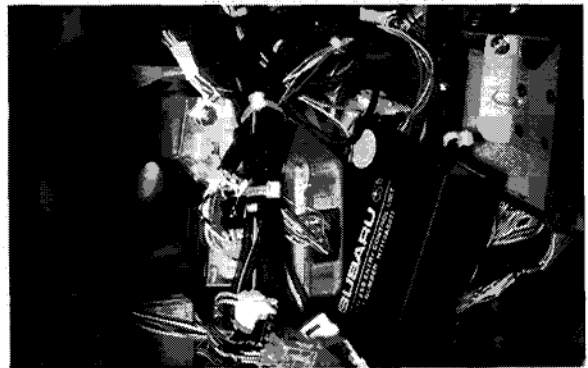

Mounting the Keyless Entry Module

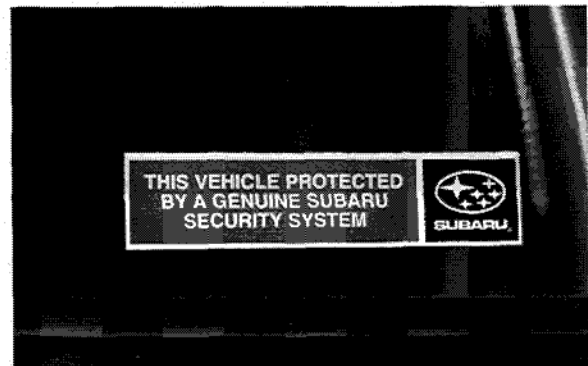

Window Decal

# AN INTRODUCTION TO KEYLESS ENTRY AND THEFT DETERRENT SYSTEMS

## CONCLUSION

Be sure to use the *Keyless Entry and Vehicle Security Systems Installation Reference Guide* and this Video Reference Booklet, and you will be able to program the SVX, 1990 - '94 Legacy, and Code Alarm systems, and install the Code Alarm systems.

### Service Bulletins and Helpline Updates

#### SVX

*SB 15-90-01* SVX Security System Precaution

*SB 15-97-93* SVX Security System (Main Switch)

*HU 10-91* SVX Security System

*HU 1-92* SVX Security System Warning

*HU 2-92* LED Interpretation

*HU 8-93* '93 SVX New Security System Installation Tips

*HU 10-93* Legacy and SVX Security System Transmitter Battery Servicing

*HU 10-94* Security System in 1997 SVX with Dual SRS System

#### 1990-'94 Legacy

*HU 4-92* Legacy Security System Wiring Information

*HU 10-93*

*HU 10-94* 1990 - 1994 Legacy Security System Operation Q&A

#### 1995 - '97 LSi

*HU 7-94* 1995 Legacy Security System

*HU 9-94* 1995 Legacy LSi Security System

*HU 4-95* 1995 Legacy LSi Security Systems Module

*HU 6-95* 1995 Subaru Legacy LSi Alarm System

*HU 12-95* Legacy Remote Keyless Entry System

*HU 1-96* Legacy Keyless Entry Diagnosis

Legacy Accessory Keyless Entry System

*HU 8-96* '97 Legacy Keyless Entry

# AN INTRODUCTION TO KEYLESS ENTRY AND THEFT DETERRENT SYSTEMS

Mark your answers to the following questions and mail the quiz to Subaru Video Training Program Headquarters.

Name \_\_\_\_\_

Dealer \_\_\_\_\_ Dealer Code \_\_\_\_\_

1. The original SVX theft deterrent system is...
  - a. Active only.
  - b. Passive only.
  - c. Active and passive.
  - d. None of the above.
2. The original SVX theft deterrent system needs to be reprogrammed for the remote transmitters:
  - a. When a transmitter battery is replaced.
  - b. Any time vehicle battery power is lost.
  - c. Only when a transmitter is replaced.
  - d. None of the above.
3. The original SVX theft deterrent system is Off when the security button is out, and On when the button is pushed in.
  - a. True
  - b. False
4. The revised SVX theft deterrent system, introduced in 1993, is ...
  - a. Active only.
  - b. Passive only.
  - c. Active and passive.
  - d. None of the above.
5. The revised SVX theft deterrent system is...
  - a. Off when the switch is out, and On when the switch is pushed in.
  - b. On when the switch is out, and Off when the switch is pushed in.
  - c. On when the switch's LED is dark, and Off when the switch's LED blinks.
  - d. Off when the switch's LED is dark, and On when the switch's LED blinks.
6. The base theft deterrent system on a 1990 - '94 Legacy is...
  - a. Active only.
  - b. Passive only.
  - c. Active and passive.
  - d. None of the above.
7. The mid-level theft deterrent system on a 1990 - '94 Legacy includes...
  - a. Keyless entry only.
  - b. Remote arming and disarming only.
  - c. Both keyless entry and remote arming/disarming.
  - d. None of the above.
8. The mid-level and high-level 1990 - '94 Legacy theft deterrent systems need to be reprogrammed:
  - a. When a transmitter battery is replaced.
  - b. Any time vehicle power is lost.
  - c. Only when a transmitter is replaced.
  - d. None of the above.
9. The theft deterrent system on a 1995 - '96 LSi arms itself...
  - a. When the driver exits from the vehicle and locks the doors with a key.
  - b. When the driver locks the door with a door lock.
  - c. When the driver presses the "Lock" button on the remote transmitter, on 1995 - '96 LSi's equipped with keyless entry.
  - d. All of the above.
10. With the Code Alarm systems for the 1997 - '98 Impreza, 1995 - '98 Legacy, and 1998 Forester, the keyless entry control module includes the electronics for theft deterrent.
  - a. True
  - b. False

Tear out answer sheet and insert it in the envelope provided