

POWER SUPPLY ROUTING

Wiring System

4. Power Supply Routing

S903465

A: SCHEMATIC

S903465A21

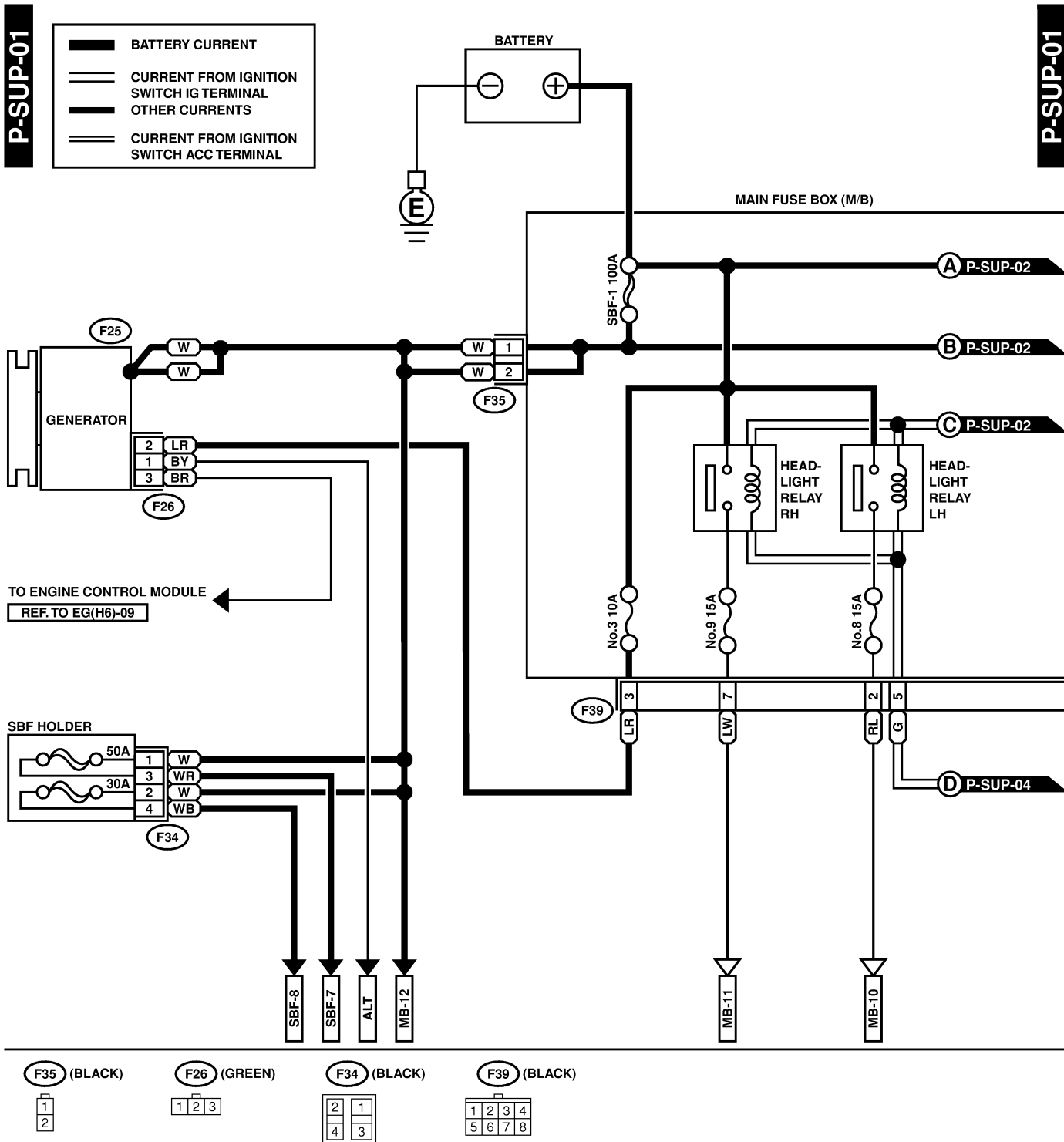

POWER SUPPLY ROUTING

Wiring System

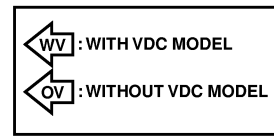
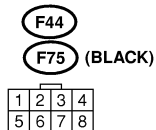
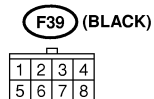
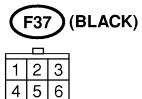
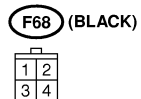
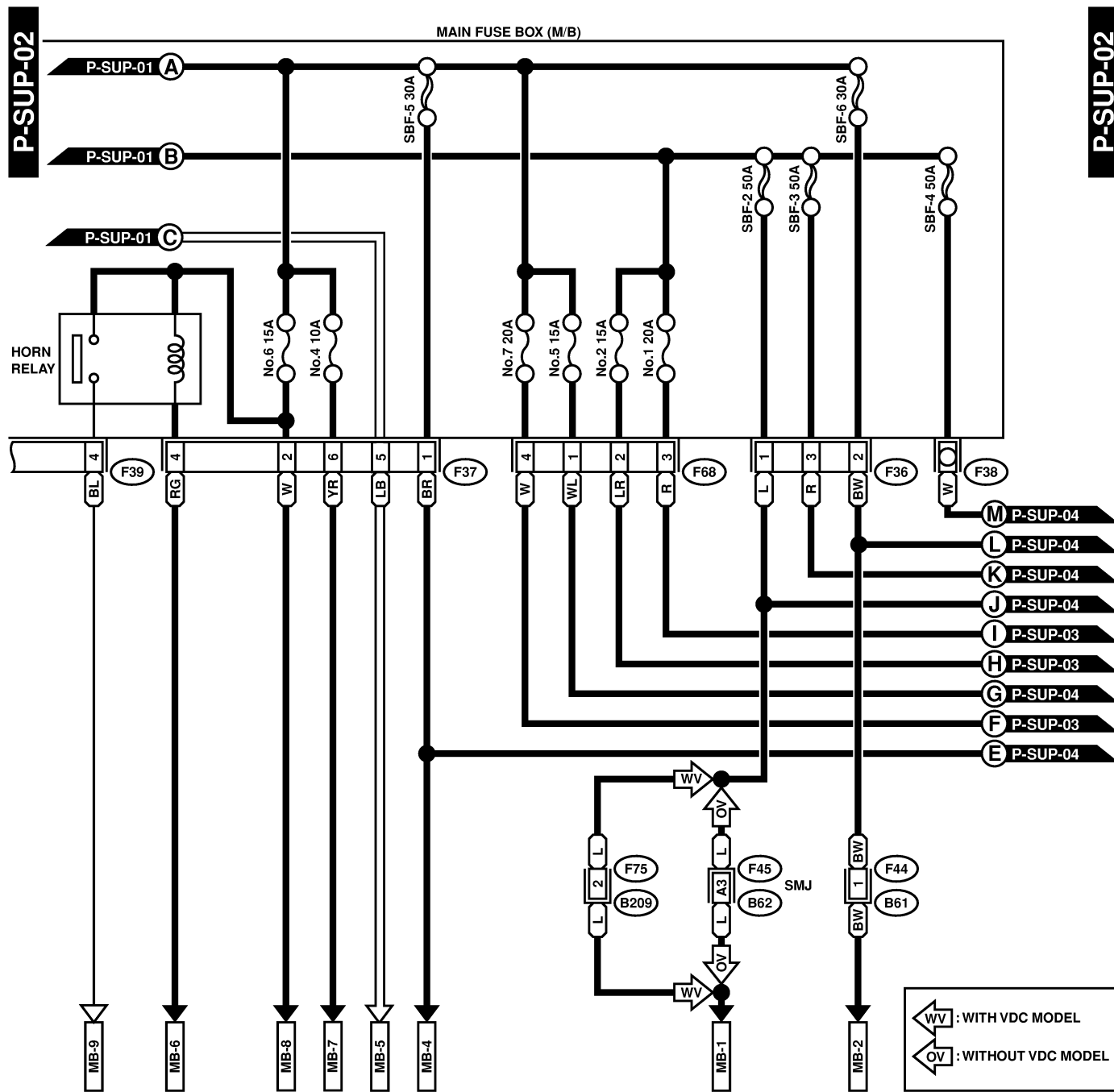

POWER SUPPLY ROUTING

Wiring System

P-SUP-03

P-SUP-03

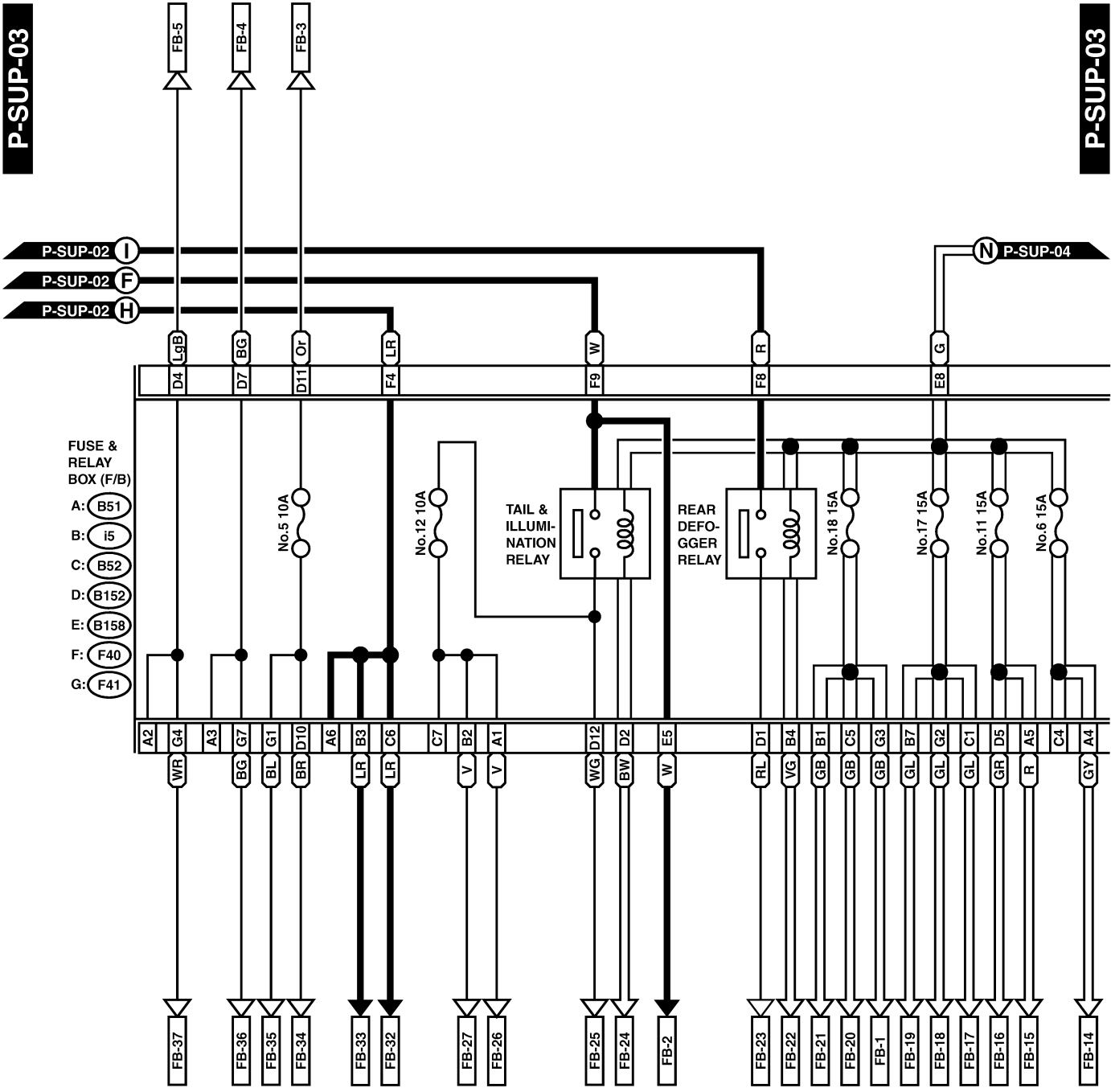

C: (B52) G: (F41) (GRAY)

A: (B51)

F: (F40) (BROWN)

E: (B158)

B: (i5) D: (B152)

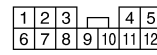
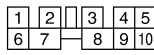
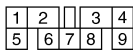
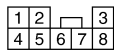
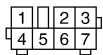

POWER SUPPLY ROUTING

Wiring System

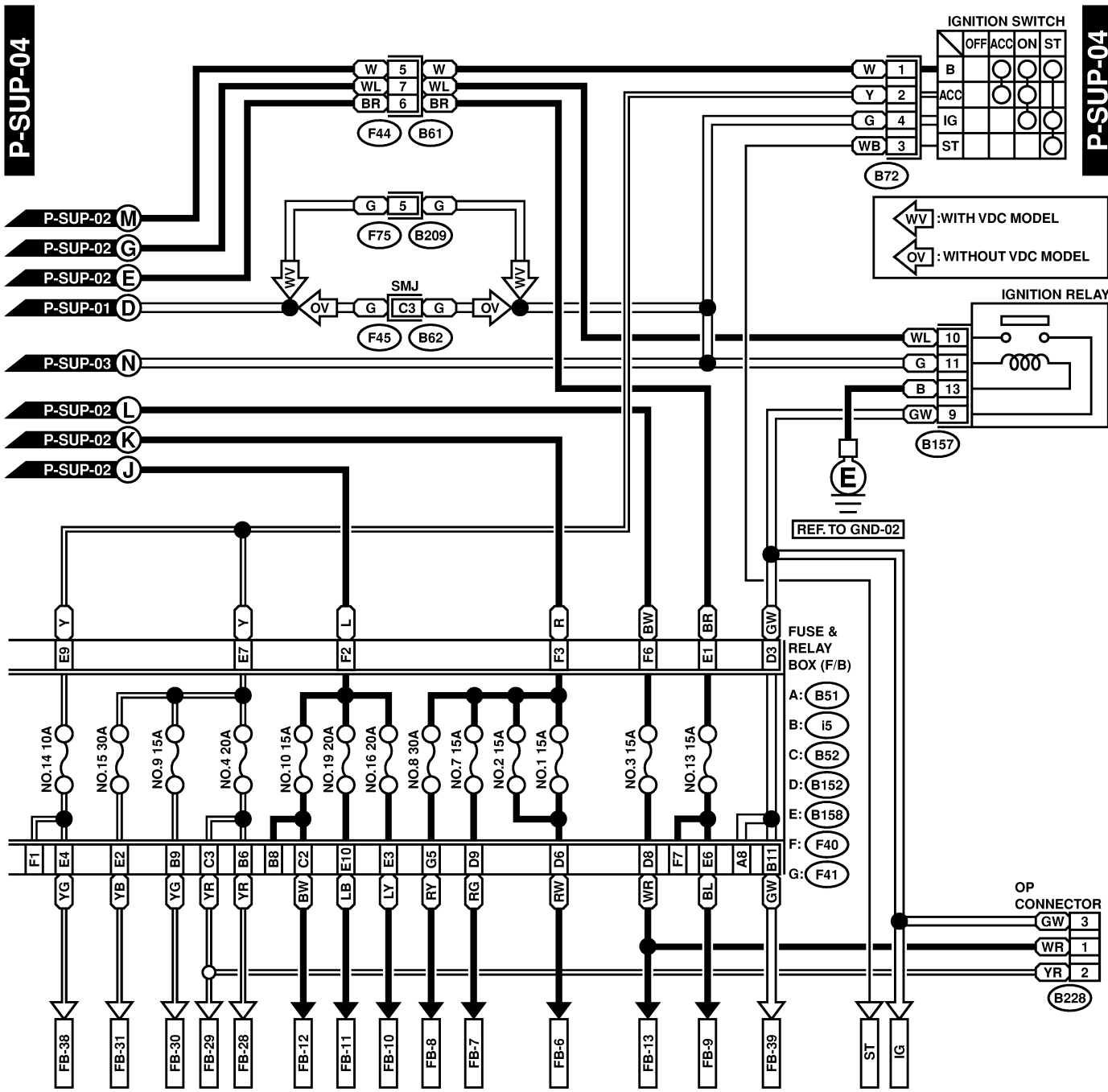

B72 (BLUE)



C: B52

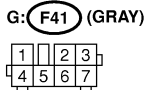

A: B51

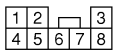

F44



F: F40 (BROWN)

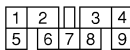

E: B158

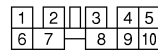

B: I5

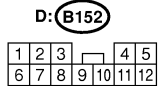

B228

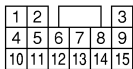

B157

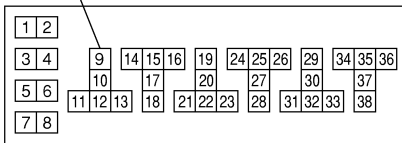

RELAY BLOCK (BLACK)

POWER SUPPLY ROUTING

Wiring System

No.	Load
MB-1	Fuse (Seat heater)
MB-2	Power window circuit breaker
MB-4	Data link connector Engine control module Main relay
MB-5	Daytime running light control module OP connector
MB-6	Cruise control sub switch Horn switch Keyless entry control module Security horn relay
MB-7	Transmission control module
MB-8	AT shift lock control module Hazard switch Key warning switch
MB-9	Horn
MB-10	Headlight LH
MB-11	Combination meter Headlight RH
MB-12	A/C relay holder (Fuse)
SBF-7	ABS control module Relay box (VDC)
SBF-8	Fuse (Mcintosh audio)
ALT	Combination meter
IG	Check connector Keyless entry control module Seat belt timer Security control module Vehicle speed sensor (MT)
ST	Cruise control module (AT) Engine control module Inhibitor switch (AT) Interrupt relay Starter interlock relay (MT)
FB-1	ABS control module Main fan relay (4-cylinder engine model) Main fan relay-1 (6-cylinder engine model) Main fan relay-2 (6-cylinder engine model) VDC control module
FB-2	Parking switch Security control module
FB-3	Parking switch Security control module
FB-4	Combination meter Hazard switch Rear turn signal light LH Trailer connector Turn signal switch
FB-5	Combination meter Hazard switch Rear turn signal light RH Trailer connector Turn signal switch
FB-6	Blower motor relay
FB-7	Front fog light relay
FB-8	ABS control module Relay box (VDC)

No.	Load
FB-9	Fuel pump relay
FB-10	Stop light switch
FB-11	Wiper deicer relay
FB-12	Trailer connector
FB-13	Door lock timer Keyless entry control module
FB-14	Airbag control module
FB-15	Airbag control module
FB-16	Daytime running light control module Daytime running light relay (4-light model) Engine control module Fuel pump relay Ignition coil and ignitor (4-cylinder engine model) Ignition coil No. 1 — 6 (6-cylinder engine model) Transmission control module
FB-17	A/C pressure switch Blower motor relay Fan relay (6-cylinder engine model)
FB-18	A/C relay Sub fan relay (4-cylinder engine model) Sub fan relay-1 (6-cylinder engine model) Sub fan relay-2 (6-cylinder engine model)
FB-19	Auto A/C control module Mode control panel
FB-20	AT shift lock control module Back-up light switch (MT) Cruise control module Inhibitor switch (AT) Power window relay Wiper deicer relay Wiper deicer timer
FB-21	Cruise control main switch
FB-22	Engine control module Rear defogger switch
FB-23	Rear defogger Rear defogger condenser
FB-24	Engine control module Lighting switch OP connector
FB-25	Parking switch
FB-26	Illumination control module Illumination light OP connector
FB-27	Combination meter Illumination light
FB-28	Auto A/C control module Front accessory power supply socket Multiple power socket relay (Option)
FB-29	AT shift lock control module Mirror heater LH Mirror heater RH Remote control rearview mirror switch Seat heater/rear accessory power supply relay Vanity mirror illumination light

POWER SUPPLY ROUTING

Wiring System

No.	Load
FB-30	Radio
FB-31	Front washer motor Front wiper motor Front wiper & washer switch
FB-32	Luggage room light Room light Security control module Security horn relay Spot light Step light Trunk room light
FB-33	Auto A/C control module Combination meter Radio
FB-34	License plate light LH License plate light RH Rear finisher light LH Rear finisher light RH Tail light LH Tail light RH Trailer connector
FB-35	Front clearance light LH Front clearance light RH
FB-36	Front turn signal light LH
FB-37	Front turn signal light RH
FB-38	Rear washer motor Rear wiper intermittent module Rear wiper motor
FB-39	Combination meter Hazard switch