

AUTOMATIC AIR CONDITIONING SYSTEM

Wiring System

8. Automatic Air Conditioning System

S903806

A: SCHEMATIC

S903806A21

1. 4-CYLINDER ENGINE MODEL

S903806A2101

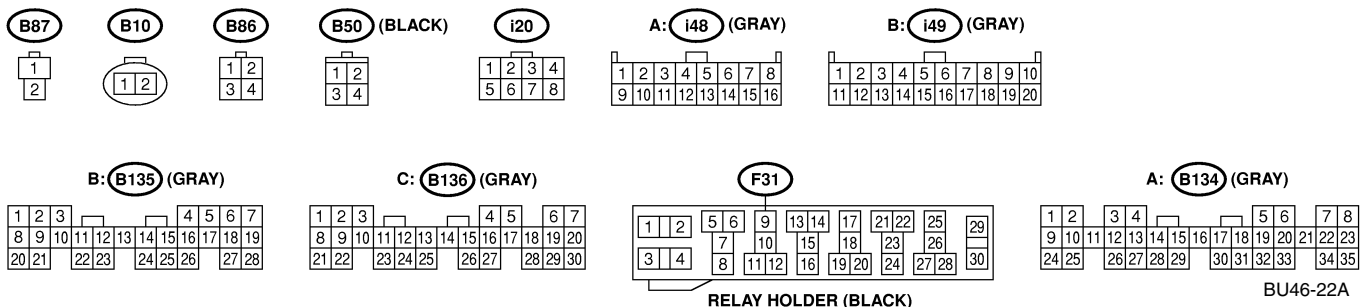
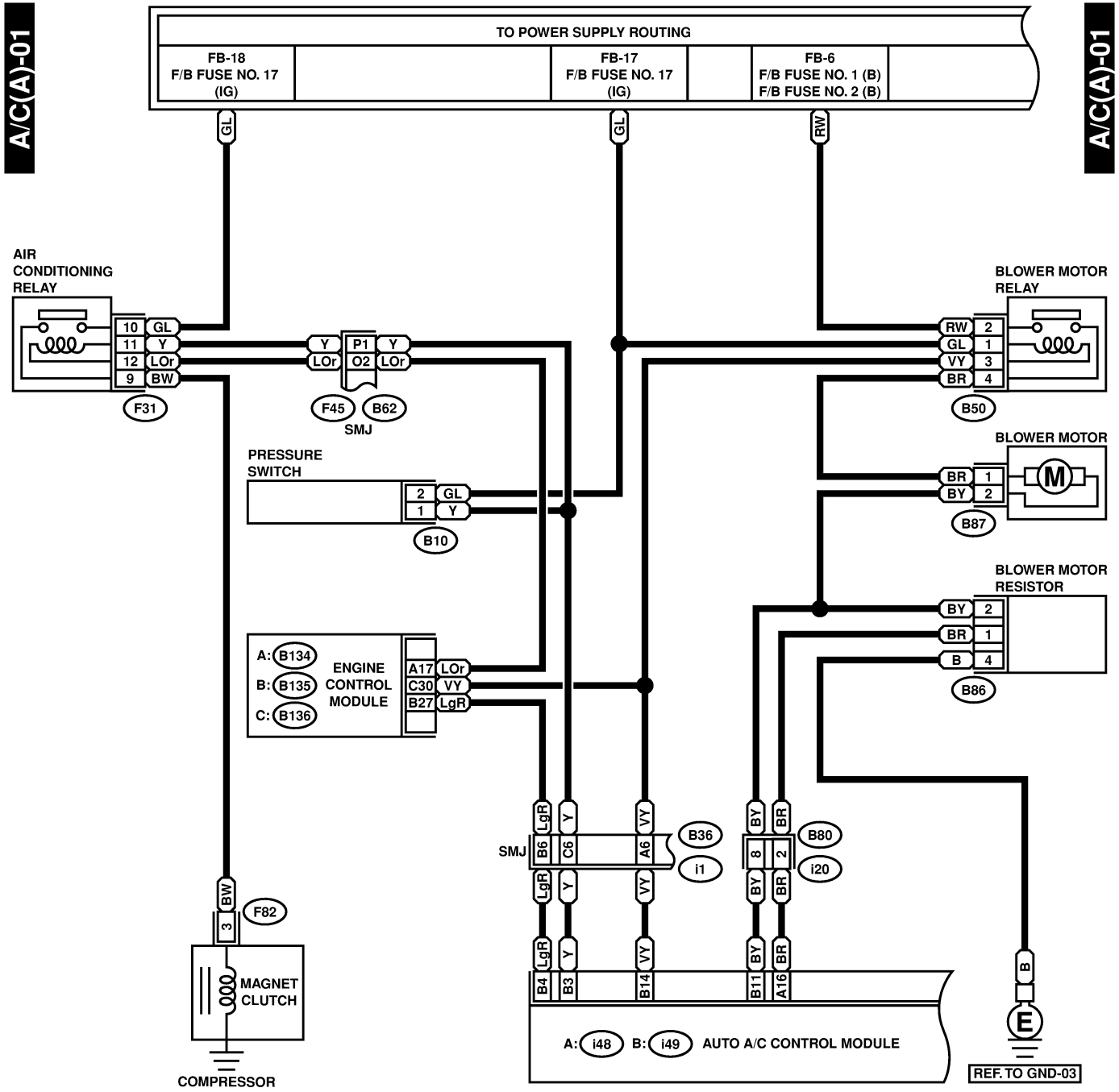

BU46-22A

AUTOMATIC AIR CONDITIONING SYSTEM

Wiring System

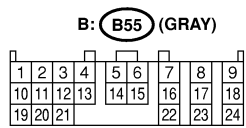
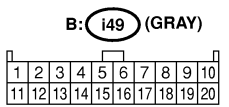
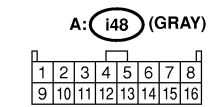
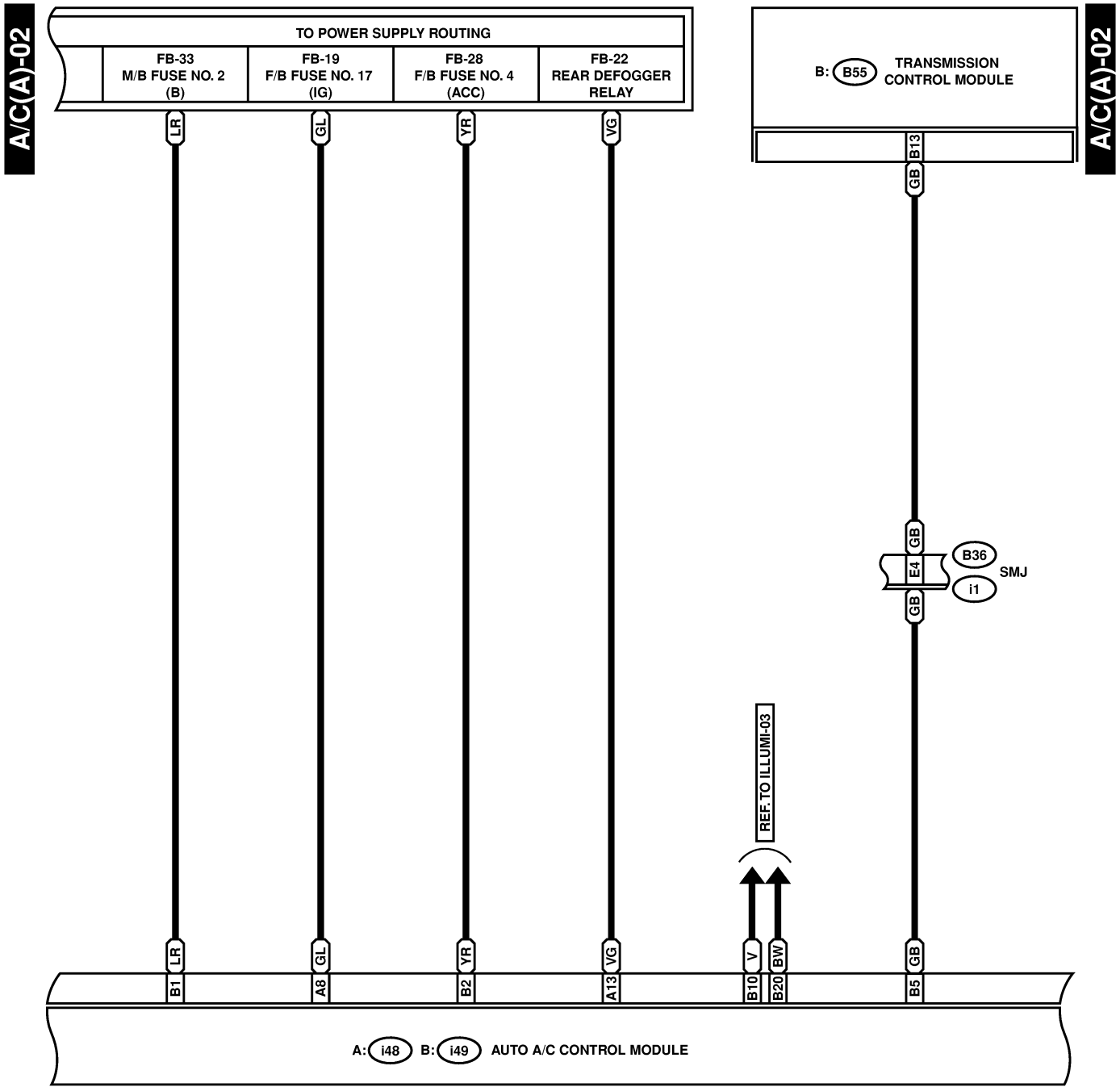

AUTOMATIC AIR CONDITIONING SYSTEM

Wiring System

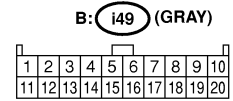
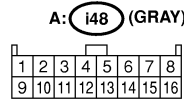
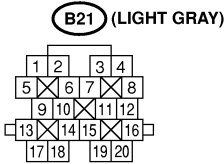
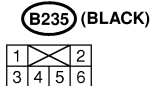
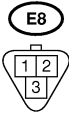
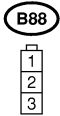
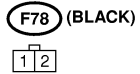
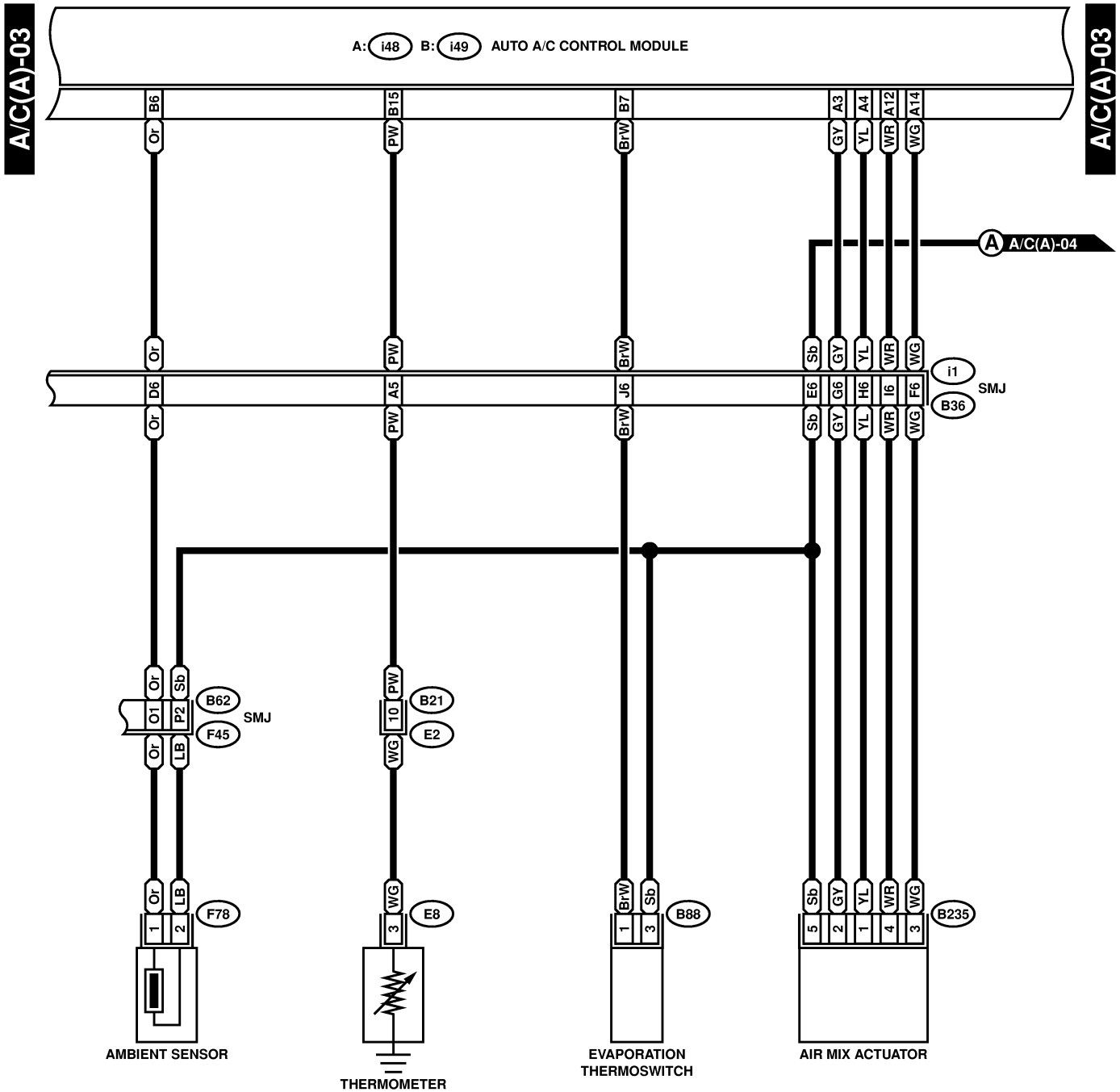

AUTOMATIC AIR CONDITIONING SYSTEM

Wiring System

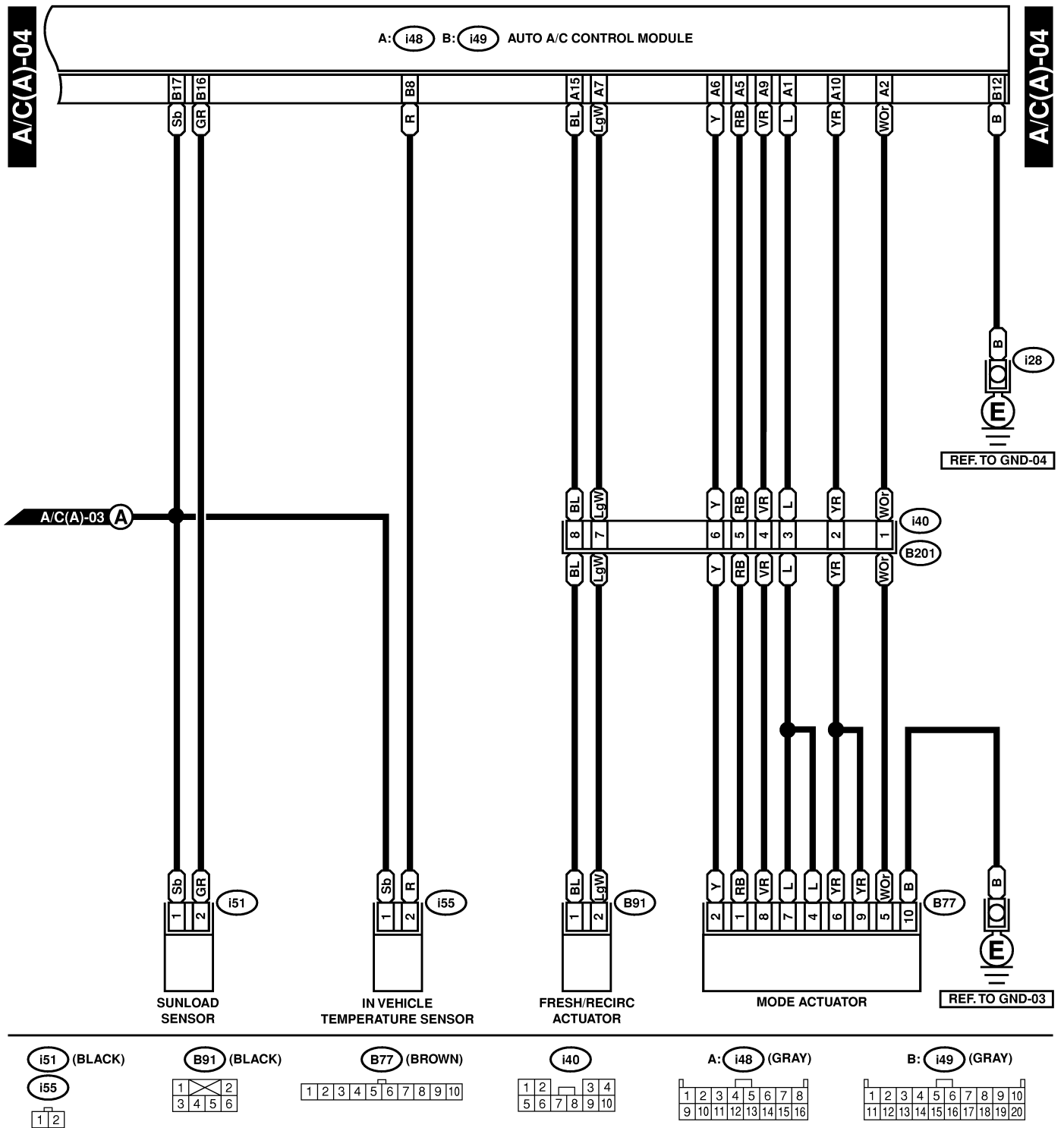

AUTOMATIC AIR CONDITIONING SYSTEM

Wiring System

2. 6-CYLINDER ENGINE MODEL S903806A2102

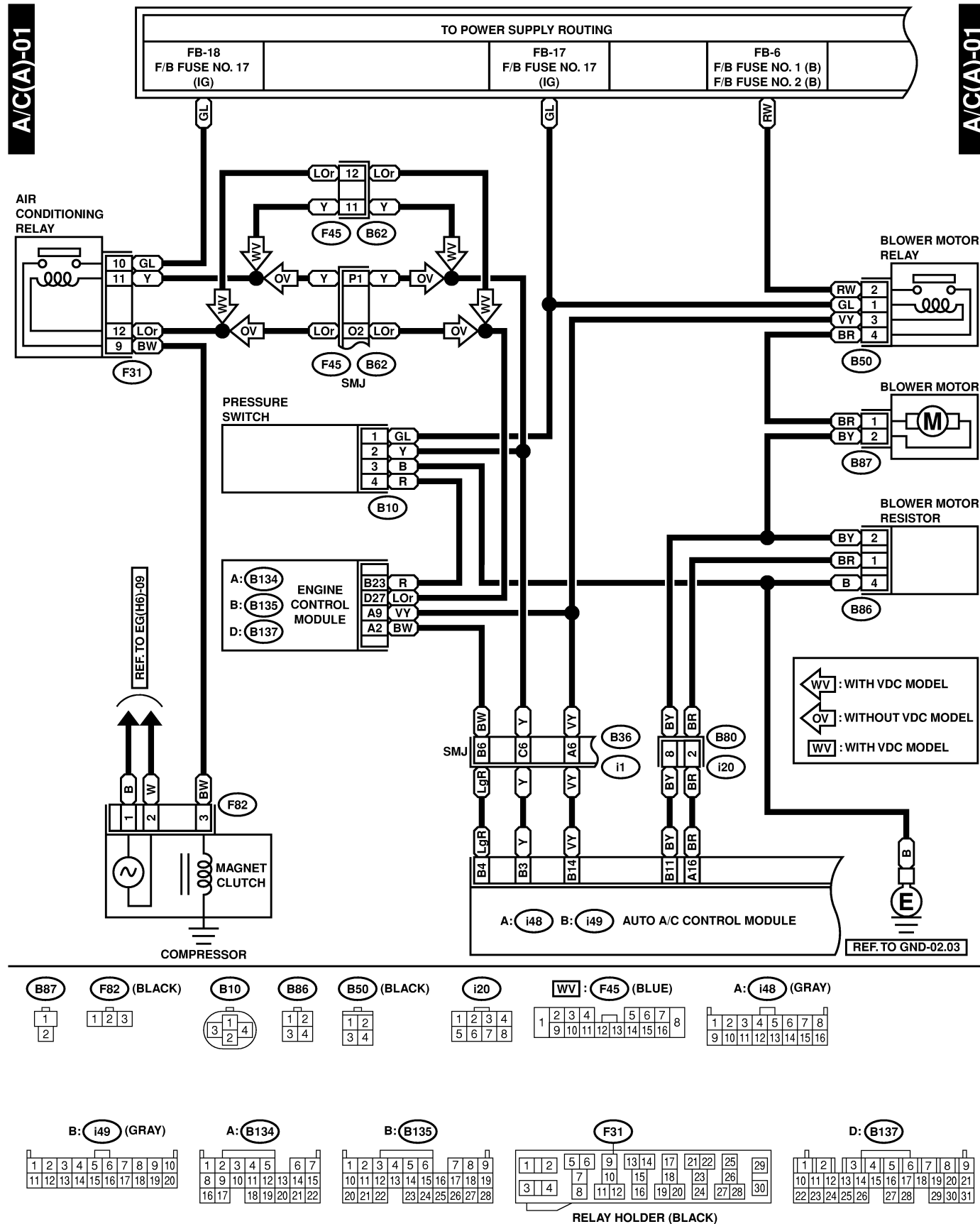

AUTOMATIC AIR CONDITIONING SYSTEM

Wiring System

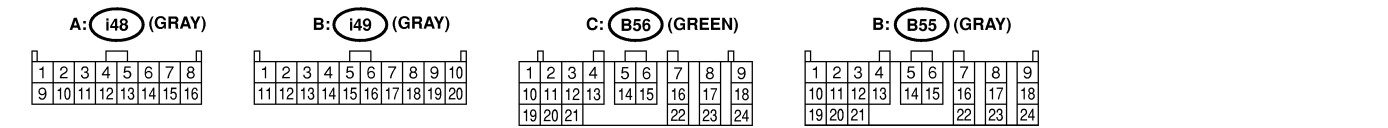
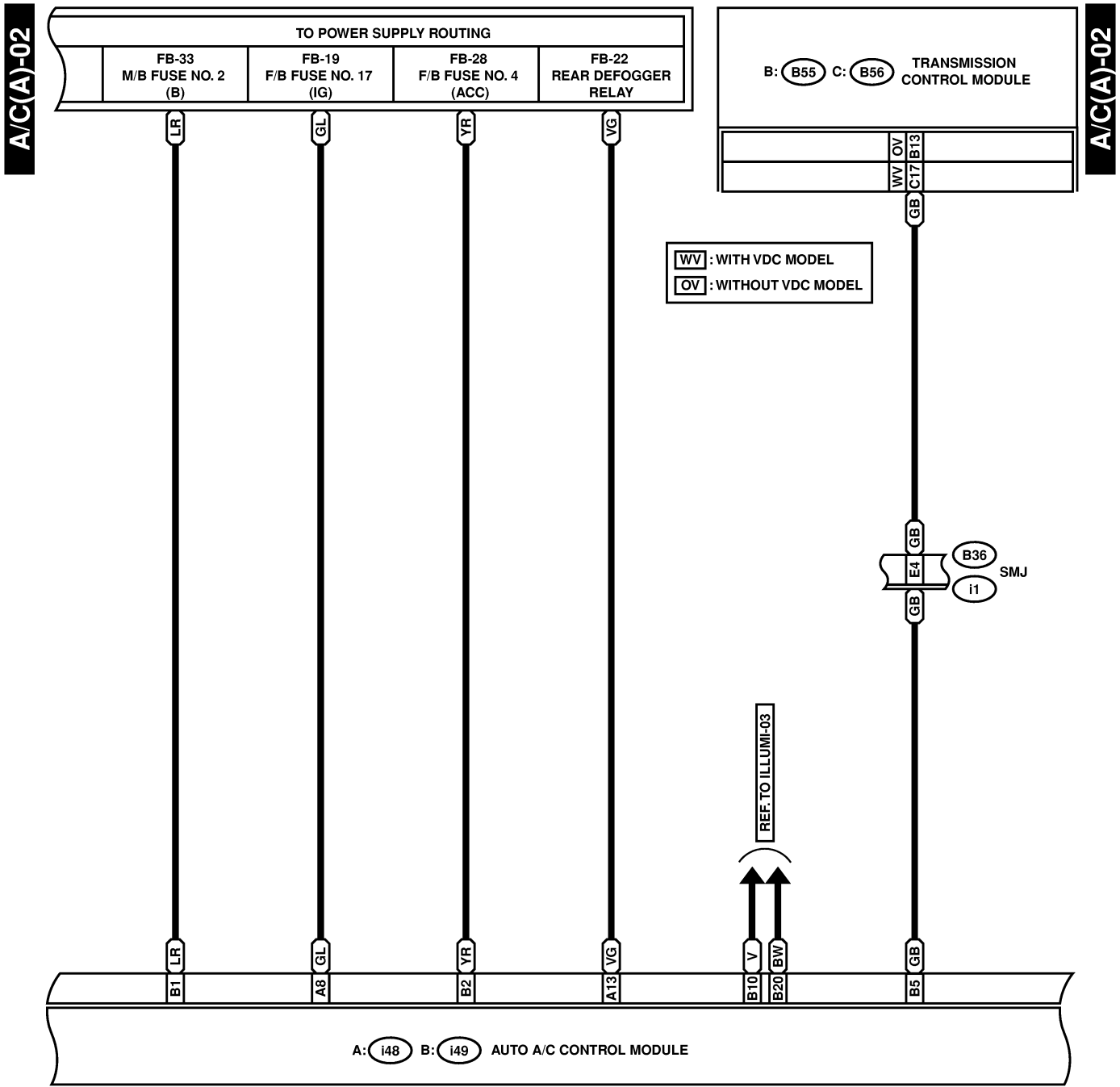

AUTOMATIC AIR CONDITIONING SYSTEM

Wiring System

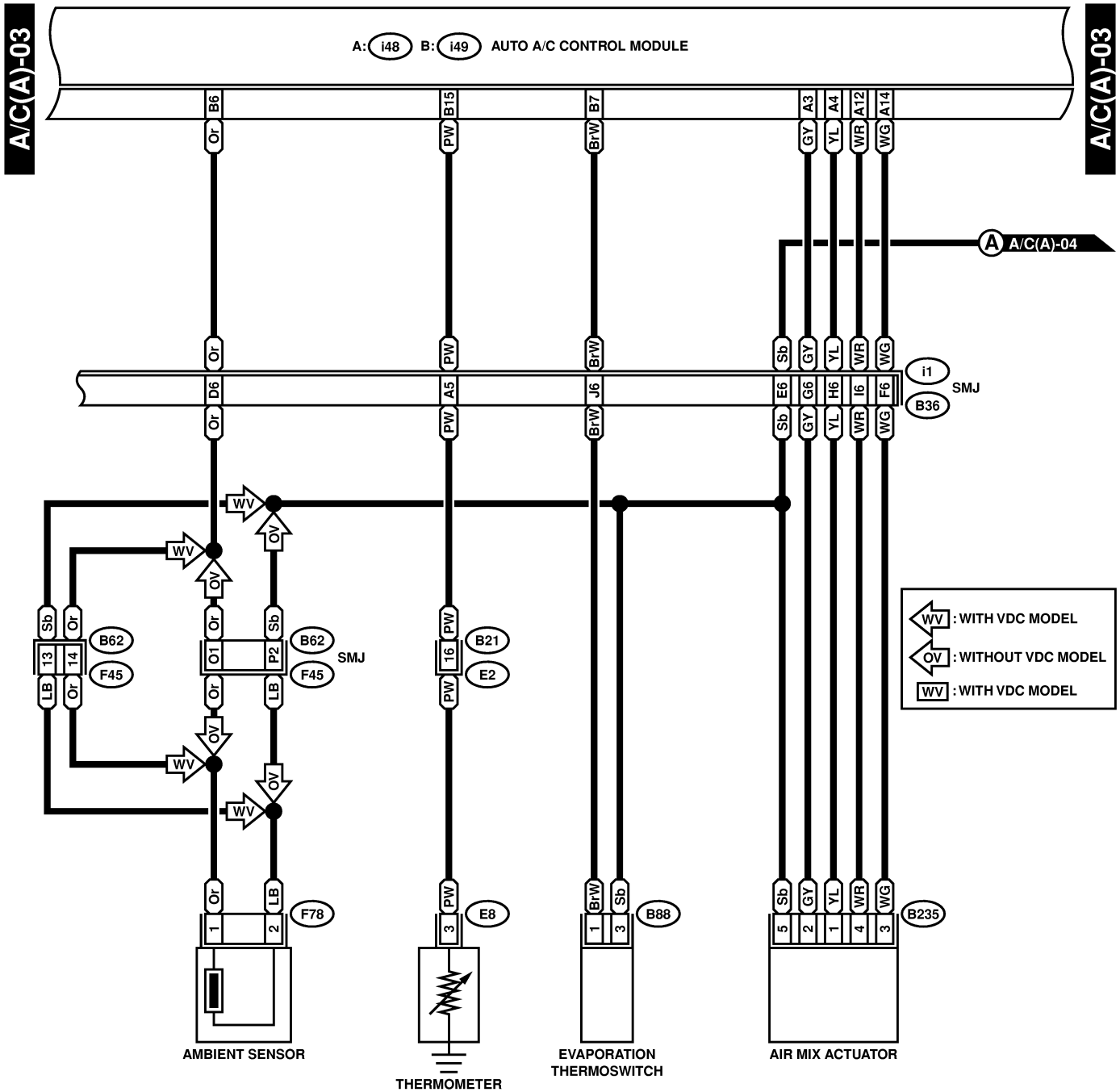

F78 (BLACK)



B88



E8 (LIGHT GRAY)



B235 (BLACK)



WV : F45 (BLUE)

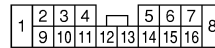

A: i48 (GRAY)

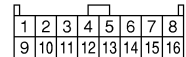

B21 (LIGHT GRAY)

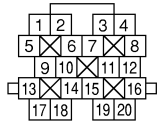

B: i49 (GRAY)

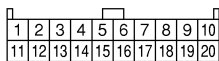

AUTOMATIC AIR CONDITIONING SYSTEM

Wiring System

