

12. Front Sub Sensor

A: REMOVAL

- 1) Turn ignition switch OFF.
- 2) Disconnect the ground cable from the battery, and wait for at least 20 seconds before starting work.
- 3) Remove front bumper. <Ref. to EI-14, REMOVAL, Front Bumper.>
- 4) Disconnect connector from front sub sensor.

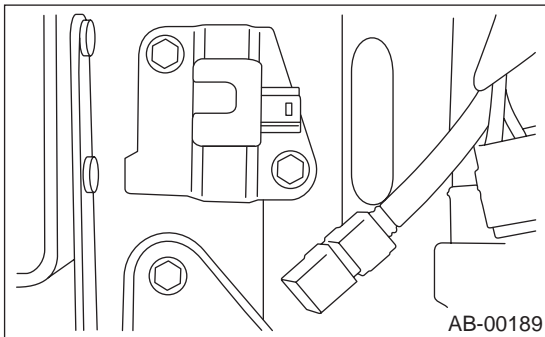

- 5) Remove front sub sensor (A).

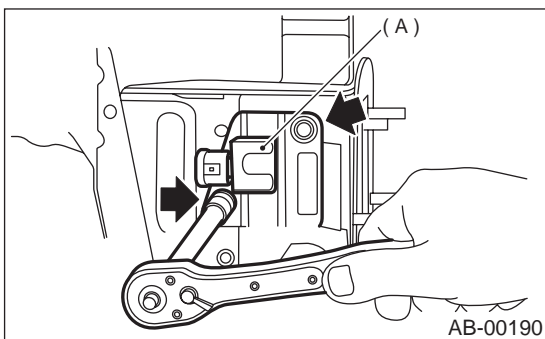

B: INSTALLATION

Install in the reverse order of removal.

C: INSPECTION

Check for the following, and replace damaged parts with new parts.

- Front sub sensor, mounting bracket, and connector are damaged.