

FRONT SUB SENSOR HARNESS

AIRBAG SYSTEM

13. Front Sub Sensor Harness

A: REMOVAL

- 1) Turn ignition switch OFF.
- 2) Disconnect the ground cable from the battery, and wait for at least 20 seconds before starting work.
- 3) Remove instrument panel. <Ref. to EI-37, REMOVAL, Instrument Panel Assembly.>
- 4) Disconnect front sub sensor connector (blue) from airbag main harness.

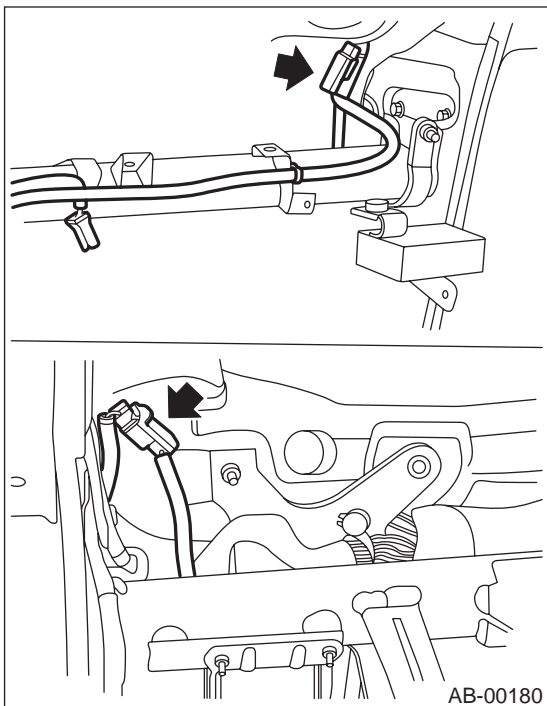

- 5) Remove front bumper. <Ref. to EI-14, REMOVAL, Front Bumper.>
- 6) Disconnect connector from front sub sensor.

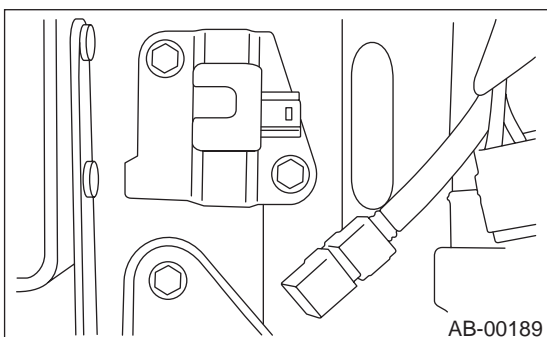

- 7) Remove wiring harness clips.

- 8) Remove grommet, and then detach front sub sensor harness (A).

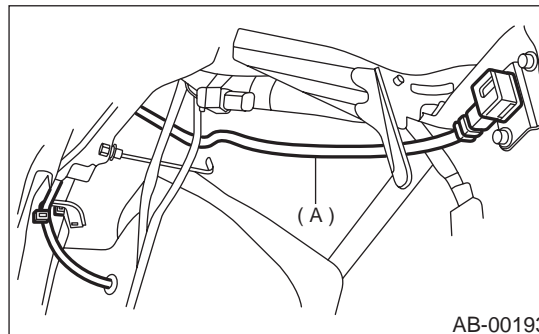

B: INSTALLATION

Install in the reverse order of removal.

C: INSPECTION

Check for the following, and replace damaged parts.

- Harness and/or connector is damaged.