

FUEL TEMPERATURE SENSOR

EMISSION CONTROL (AUX. EMISSION CONTROL DEVICES)

8. Fuel Temperature Sensor

A: REMOVAL

WARNING:

During work procedures, if fuel tank is more than 3/4 full, be careful because fuel may spill.

NOTE:

Fuel temperature sensor is built in fuel pump assembly.

- 1) Remove fuel pump assembly. <Ref. to FU(H4SO)-69, REMOVAL, Fuel Pump.>
- 2) Disconnect connector from fuel pump bracket.

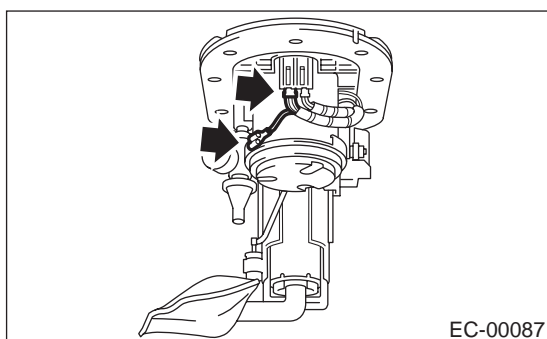

- 3) Remove fuel temperature sensor.

NOTE:

When replacing fuel temperature sensor, also replace fuel level sensor. <Ref. to FU(H4SO)-71, REMOVAL, Fuel Level Sensor.>

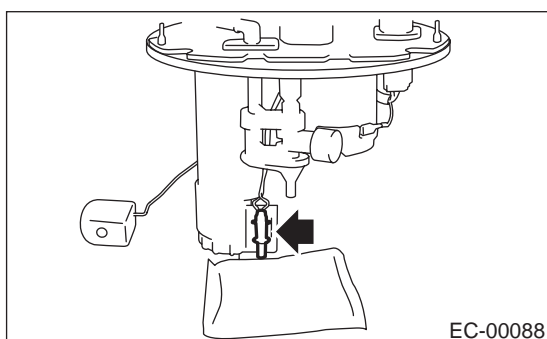

B: INSTALLATION

- 1) Install in the reverse order of removal.

WARNING:

- Ground cable must be connected.
- Spark may occur and ignite if fuel is nearby.

