

VENT VALVE

EMISSION CONTROL (AUX. EMISSION CONTROL DEVICES)

14. Vent Valve

A: REMOVAL

- 1) Remove fuel tank. <Ref. to FU(H4SO)-53, REMOVAL, Fuel Tank.>
- 2) Move clips, and disconnect hoses from vent valve.

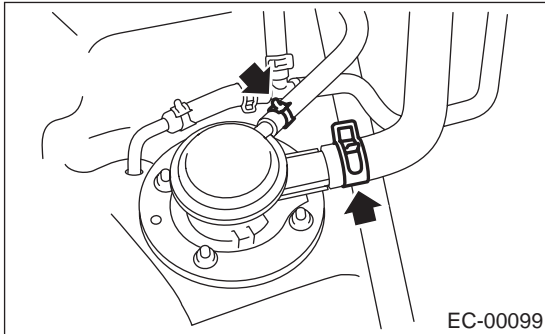

- 3) Remove nuts which install vent valve on fuel tank.

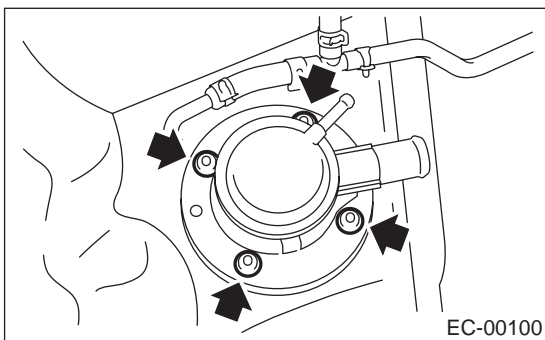

B: INSTALLATION

Install in the reverse order of removal.

NOTE:

Replace rubber seat with a new one.

Tightening torque:

4.4 N·m (0.45 kgf-m, 3.3 ft-lb)

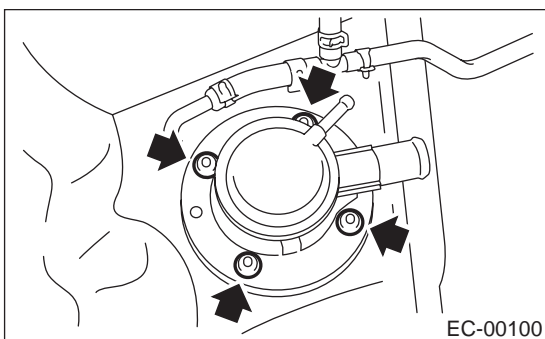

C: INSPECTION

Make sure that hoses are not cracked or loose.