

PRESSURE CONTROL SOLENOID VALVE

EMISSION CONTROL (AUX. EMISSION CONTROL DEVICES)

11. Pressure Control Solenoid Valve

A: REMOVAL

- 1) Set the vehicle on the lift.
- 2) Disconnect battery ground cable.

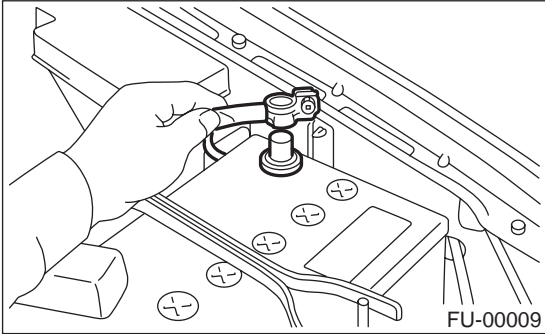

- 3) Lift-up the vehicle.
- 4) Disconnect connector from pressure control solenoid valve.

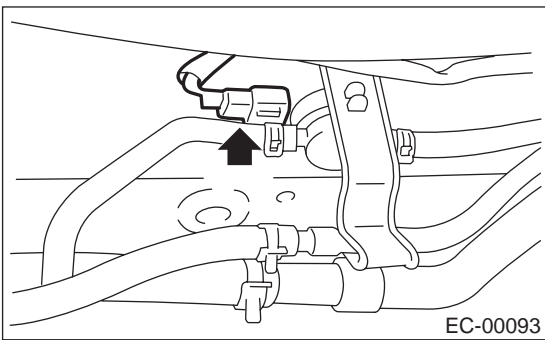

- 5) Disconnect two evaporation hoses from pressure control solenoid valve.

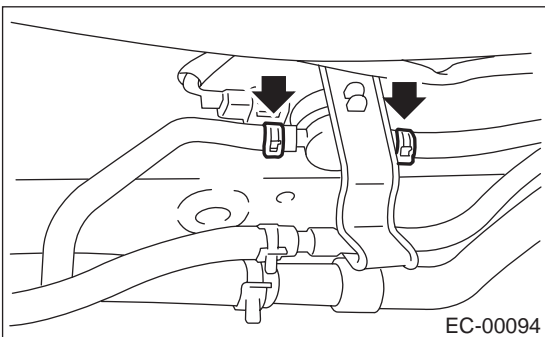

- 6) Remove pressure control solenoid valve from bracket.

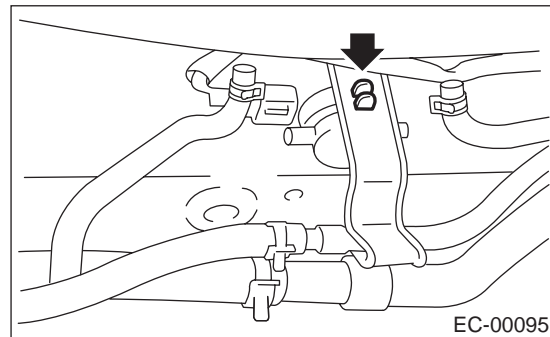

B: INSTALLTION

Install in the reverse order of removal.

C: INSPECTION

Make sure that hoses are not cracked or loose.