

ABS (DIAGNOSTICS)

ABS

	Page
1. Basic Diagnostic Procedure	2
2. Check List for Interview	5
3. General Description	8
4. Electrical Components Location.....	10
5. Control Module I/O Signal	12
6. Subaru Select Monitor.....	16
7. Read Diagnostic Trouble Code (DTC)	19
8. Inspection Mode	21
9. Clear Memory Mode.....	22
10. ABS Warning Light Illumination Pattern	23
11. List of Diagnostics Trouble Code (DTC)	24
12. Diagnostics Chart with Diagnosis Connector	28
13. Diagnostics Chart with Subaru Select Monitor	78
14. General Diagnostics Table	145

BASIC DIAGNOSTIC PROCEDURE

ABS (DIAGNOSTICS)

1. Basic Diagnostic Procedure

A: PROCEDURE

1. WITHOUT SUBARU SELECT MONITOR

CAUTION:

Remove foreign matter (dust, water, etc.) from the ABSCM&H/U connector during removal and installation.

NOTE:

- To check harness for broken wires or short circuits, shake it while holding it or the connector.
- When ABS warning light illuminates, read and record diagnostic trouble code (DTC) indicated by ABS warning light.

Step	Check	Yes	No
1 CHECK PRE-INSPECTION. 1) Ask the customer when and how the trouble occurred using interview checklist. <Ref. to ABS-5, Check List for Interview.> 2) Before performing diagnosis, inspect unit which might influence the ABS problem. <Ref. to ABS-8, INSPECTION, General Description.>	Is the component part that might influence the ABS problem normal?	Go to step 2.	Repair or replace each unit.
2 CHECK INDICATION OF DIAGNOSTIC TROUBLE CODE (DTC). Calling up diagnostic trouble code (DTC). <Ref. to ABS-19, Read Diagnostic Trouble Code (DTC).>	Is ABS warning light normal?	Go to step 3.	Inspect using diagnostic chart for ABS warning light failure.<Ref. to ABS-28, Diagnostics Chart with Diagnosis Connector.> NOTE: Call up diagnostic trouble code (DTC) again after inspecting ABS warning light. <Ref. to ABS-19, Read Diagnostic Trouble Code (DTC).>
3 CHECK DIAGNOSTIC TROUBLE CODE (DTC). NOTE: Record all diagnostic trouble codes (DTC).	Is only the start code displayed?	Go to step 4.	Go to step 5.
4 PERFORM THE GENERAL DIAGNOSTICS. 1) Inspect using "General Diagnostics Table". <Ref. to ABS-145, General Diagnostics Table.> 2) Perform the clear memory mode. <Ref. to ABS-22, WITHOUT SUBARU SELECT MONITOR, OPERATION, Clear Memory Mode.> 3) Perform the inspection mode. <Ref. to ABS-21, Inspection Mode.> Calling up the diagnostic trouble code (DTC). <Ref. to ABS-19, Read Diagnostic Trouble Code (DTC).>	Is only the start code displayed?	Complete the diagnosis.	Go to step 5.

BASIC DIAGNOSTIC PROCEDURE

ABS (DIAGNOSTICS)

Step	Check	Yes	No
<p>5 PERFORM THE DIAGNOSIS.</p> <p>1) Inspect using "Diagnostics Chart with Diagnostic Connector". <Ref. to ABS-28, Diagnostics Chart with Diagnosis Connector.></p> <p>NOTE: For diagnostic trouble code (DTC) list, refer to "List of Diagnostics Trouble Code (DTC)". <Ref. to ABS-24, WITHOUT SUBARU SELECT MONITOR, LIST, List of Diagnostics Trouble Code (DTC).></p> <p>2) Repair trouble cause.</p> <p>3) Perform the clear memory mode. <Ref. to ABS-22, WITHOUT SUBARU SELECT MONITOR, OPERATION, Clear Memory Mode.></p> <p>4) Perform the inspection mode. <Ref. to ABS-21, Inspection Mode.></p> <p>5) Calling up the diagnostic trouble code (DTC). <Ref. to ABS-19, Read Diagnostic Trouble Code (DTC).></p>	Is only the start code displayed?	Complete the diagnosis.	Inspect using "Diagnostics Chart with Diagnostic Connector". <Ref. to ABS-28, Diagnostics Chart with Diagnosis Connector.>

2. WITH SUBARU SELECT MONITOR

CAUTION:

Remove foreign matter (dust, water, etc.) from the ABSCM&H/U connector during removal and installation.

NOTE:

- To check harness for broken wires or short circuits, shake it while holding it or the connector.
- Check list for interview. <Ref. to ABS-25, WITH SUBARU SELECT MONITOR, LIST, List of Diagnostics Trouble Code (DTC).>

Step	Check	Yes	No
<p>1 CHECK PRE-INSPECTION.</p> <p>1) Ask the customer when and how the trouble occurred using interview checklist. <Ref. to ABS-5, Check List for Interview.></p> <p>2) Before performing diagnosis, inspect unit which might influence the ABS problem. <Ref. to ABS-8, INSPECTION, General Description.></p>	Is unit that might influence the ABS problem normal?	Go to step 2.	Repair or replace each unit.
<p>2 CHECK INDICATION OF TROUBLE CODE DISPLAY.</p> <p>1) Turn ignition switch to OFF.</p> <p>2) Connect the SUBARU SELECT MONITOR to data link connector.</p> <p>3) Turn ignition switch to ON and SUBARU SELECT MONITOR to ON.</p> <p>NOTE: If the communication function of the select monitor cannot be executed normally, check the communication circuit. <Ref. to ABS-78, COMMUNICATION FOR INITIALIZING IMPOSSIBLE, Diagnostics Chart with Subaru Select Monitor.></p> <p>4) Read diagnostic trouble code (DTC). <Ref. to ABS-17, READ CURRENT DATA, OPERATION, Subaru Select Monitor.></p> <p>5) Record all diagnostic trouble codes (DTC) and frame data.</p>	Is the DTC displayed?	Go to step 4.	Go to step 3.

BASIC DIAGNOSTIC PROCEDURE

ABS (DIAGNOSTICS)

Step	Check	Yes	No
3 PERFORM THE GENERAL DIAGNOSTICS. 1) Inspect using "General Diagnostics Table". <Ref. to ABS-145, General Diagnostics Table.> 2) Perform the clear memory mode. <Ref. to ABS-17, CLEAR MEMORY MODE, OPERATION, Subaru Select Monitor.> 3) Perform the inspection mode. <Ref. to ABS-21, Inspection Mode.> 4) Calling up the diagnostic trouble code (DTC). <Ref. to ABS-16, READ DIAGNOSTIC TROUBLE CODE (DTC), OPERATION, Subaru Select Monitor.> Confirm that no DTC is displayed.	Does ABS warning light remain off?	Complete the diagnosis.	Go to step 4.
4 PERFORM THE DIAGNOSIS. 1) Inspect using "Diagnostics Chart with Subaru Select Monitor".<Ref. to ABS-78, Diagnostics Chart with Subaru Select Monitor.> NOTE: For diagnostic trouble code (DTC) list, refer to "List of Diagnostics Trouble Code (DTC)". <Ref. to ABS-24, WITHOUT SUBARU SELECT MONITOR, LIST, List of Diagnostics Trouble Code (DTC).> 2) Repair trouble cause. 3) Perform the clear memory mode. <Ref. to ABS-17, CLEAR MEMORY MODE, OPERATION, Subaru Select Monitor.> 4) Perform the inspection mode. <Ref. to ABS-21, Inspection Mode.> 5) Calling up the diagnostic trouble code (DTC). <Ref. to ABS-16, READ DIAGNOSTIC TROUBLE CODE (DTC), OPERATION, Subaru Select Monitor.> Confirm that no DTC is displayed.	Does ABS warning light remain off?	Complete the diagnosis.	Inspect using "Diagnostics Chart with Subaru Select Monitor". <Ref. to ABS-<Ref. to ABS-78, Diagnostics Chart with Subaru Select Monitor.>, Diagnostics Chart with Subaru Select Monitor.>

CHECK LIST FOR INTERVIEW

ABS (DIAGNOSTICS)

2. Check List for Interview

A: CHECK

Check the following items about the vehicle's state.

1. STATE OF ABS WARNING LIGHT

ABS warning light comes on.	<input type="checkbox"/> Always <input type="checkbox"/> Sometimes <input type="checkbox"/> Only once <input type="checkbox"/> Does not come on • When / how long does it come on?:		
Ignition key position	<input type="checkbox"/> LOCK <input type="checkbox"/> ACC <input type="checkbox"/> ON (before starting engine) <input type="checkbox"/> START <input type="checkbox"/> On after starting (Engine is running) <input type="checkbox"/> On after starting (Engine is stop)		
Timing	<input type="checkbox"/> Immediately after ignition is ON. <input type="checkbox"/> Immediately after ignition starts.		
	<input type="checkbox"/> When advancing	km/h to	km/h
		MPH to	MPH
	<input type="checkbox"/> While traveling at a constant speed	km/h	MPH
	<input type="checkbox"/> When decelerating	km/h to	km/h
		MPH to	MPH
	<input type="checkbox"/> When turning to right	Steering angle:	deg
		Steering time:	sec
	<input type="checkbox"/> When turning to left	Steering angle:	deg
		Steering time:	sec
<input type="checkbox"/> When moving other electrical parts	• Parts name: • Operating condition:		

CHECK LIST FOR INTERVIEW

ABS (DIAGNOSTICS)

2. SYMPTOMS

ABS operating condition	<input type="checkbox"/> Performs no work.		
	<input type="checkbox"/> Operates only when abruptly applying brakes.	Vehicle speed:	km/h
			MPH
	• How to step on brake pedal:		
	a) Operating time:		sec
	b) Operating noise: <input type="checkbox"/> Produce / <input type="checkbox"/> Does not produce		
	• What kind of noise?	<input type="checkbox"/> Knock <input type="checkbox"/> Gong gong <input type="checkbox"/> Bong <input type="checkbox"/> Buzz <input type="checkbox"/> Gong gong buzz <input type="checkbox"/> Others:	
c) Reaction force of brake pedal			
	<input type="checkbox"/> Stick <input type="checkbox"/> Press down once with a clunk <input type="checkbox"/> Press and released <input type="checkbox"/> Others:		
Behavior of vehicle	a) Directional stability cannot be obtained or steering arm refuses to work when applying brakes: <input type="checkbox"/> Yes / <input type="checkbox"/> No		
	• When:	<input type="checkbox"/> Vehicle turns to right <input type="checkbox"/> Vehicle turns to left <input type="checkbox"/> Spins <input type="checkbox"/> Others:	
	b) Directional stability cannot be obtained or steering arm refuses to work when accelerating: <input type="checkbox"/> Yes / <input type="checkbox"/> No		
	• When:	<input type="checkbox"/> Vehicle turns to right <input type="checkbox"/> Vehicle turns to left <input type="checkbox"/> Spins <input type="checkbox"/> Others:	
	c) Brakes are out of order: <input type="checkbox"/> Yes / <input type="checkbox"/> No		
	• What:	<input type="checkbox"/> Braking distance is long <input type="checkbox"/> Brakes lock or drag <input type="checkbox"/> Pedal stroke is long <input type="checkbox"/> Pedal sticks <input type="checkbox"/> Others:	
	d) Poor acceleration: <input type="checkbox"/> Yes / <input type="checkbox"/> No		
	• What:	<input type="checkbox"/> Fails to accelerate <input type="checkbox"/> Engine stalls <input type="checkbox"/> Others:	
	e) Occurrence of vibration: <input type="checkbox"/> Yes / <input type="checkbox"/> No		
	• Where		
• What kind:			
f) Occurrence of abnormal noise: <input type="checkbox"/> Yes / <input type="checkbox"/> No			
• Where			
• What kind:			
g) Occurrence of other phenomena: <input type="checkbox"/> Yes / <input type="checkbox"/> No			
• What kind:			

CHECK LIST FOR INTERVIEW

ABS (DIAGNOSTICS)

3. CONDITIONS UNDER WHICH TROUBLE OCCURS

Environment	a) Weather	<input type="checkbox"/> Fine <input type="checkbox"/> Cloudy <input type="checkbox"/> Rainy <input type="checkbox"/> Snowy <input type="checkbox"/> Various/Others:	
	b) Ambient temperature	°F (°C)	
	c) Road	<input type="checkbox"/> Urban area <input type="checkbox"/> Suburbs <input type="checkbox"/> Highway <input type="checkbox"/> General road <input type="checkbox"/> Ascending slope <input type="checkbox"/> Descending slope <input type="checkbox"/> Paved road <input type="checkbox"/> Gravel road <input type="checkbox"/> Muddy road <input type="checkbox"/> Sandy place <input type="checkbox"/> Others:	
	d) Road surface	<input type="checkbox"/> Dry <input type="checkbox"/> Wet <input type="checkbox"/> New-fallen snow <input type="checkbox"/> Compressed snow <input type="checkbox"/> Frozen slope <input type="checkbox"/> Others:	
Condition	a) Brakes	Deceleration: g	
		<input type="checkbox"/> Continuous / <input type="checkbox"/> Intermittent	
	b) Accelerator	Acceleration: g	
		<input type="checkbox"/> Continuous / <input type="checkbox"/> Intermittent	
	c) Vehicle speed	km/h	MPH
		<input type="checkbox"/> Advancing <input type="checkbox"/> Accelerating <input type="checkbox"/> Reducing speed <input type="checkbox"/> Low speed <input type="checkbox"/> Turning <input type="checkbox"/> Others:	
	d) Tire inflation pressure	Front RH tire:	kPa
		Front LH tire:	kPa
		Rear RH tire:	kPa
		Rear LH tire:	kPa
	e) Degree of wear	Front RH tire:	
		Front LH tire:	
		Rear RH tire:	
		Rear LH tire:	
f) Genuine parts are used.:	<input type="checkbox"/> Yes / <input type="checkbox"/> No		
g) Chain is passed around tires.:	<input type="checkbox"/> Yes / <input type="checkbox"/> No		
h) T tire is used.:	<input type="checkbox"/> Yes / <input type="checkbox"/> No		
i) Condition of suspension alignment:			
j) Loading state:			
k) Repair parts are used.:	<input type="checkbox"/> Yes / <input type="checkbox"/> No		
• What:			
l) Others:			

3. General Description

A: CAUTION

1. SUPPLEMENTAL RESTRAINT SYSTEM “AIRBAG”

Airbag system wiring harness is routed near the ABS sensor, ABS control module and hydraulic control unit.

CAUTION:

- All airbag system wiring harness and connectors are colored yellow. Do not use electrical test equipment on these circuit.
- Be careful not to damage airbag system wiring harness when servicing the ABS sensor, ABS control module and hydraulic control unit.

B: INSPECTION

Before performing diagnostics, check the following items which might affect ABS problems:

1. BATTERY

Measure battery voltage and specific gravity of electrolyte.

Standard voltage: 12 V, or more

Specific gravity: Above 1.260

2. BRAKE FLUID

- 1) Check brake fluid level.
- 2) Check brake fluid leakage.

3. HYDRAULIC UNIT

Check the hydraulic unit.

- With brake tester <Ref. to ABS-8, CHECKING THE HYDRAULIC UNIT ABS OPERATION WITH BRAKE TESTER, INSPECTION, ABS Control Module and Hydraulic Control Unit (ABSCM&H/U).>
- Without brake tester <Ref. to ABS-7, CHECKING THE HYDRAULIC UNIT ABS OPERATION BY PRESSURE GAUGE, INSPECTION, ABS Control Module and Hydraulic Control Unit (ABSCM&H/U).>

4. BRAKE DRAG

Check brake drag.

5. BRAKE PAD AND ROTOR

Check brake pad and rotor.

- Front <Ref. to BR-14, INSPECTION, Front Brake Pad.> and <Ref. to BR-15, INSPECTION, Front Disc Rotor.>
- Rear <Ref. to BR-19, INSPECTION, Rear Brake Pad.> and <Ref. to BR-20, INSPECTION, Rear Disc Rotor.>

6. TIRE



Check tire specifications, tire wear and air pressure. <Ref. to WT-2, SPECIFICATIONS, General Description.>

GENERAL DESCRIPTION

ABS (DIAGNOSTICS)

C: PREPARATION TOOL

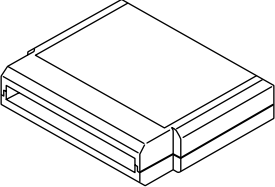
1. SPECIAL TOOLS

ILLUSTRATION	TOOL NUMBER	DESCRIPTION	REMARKS
 ST24082AA230	24082AA230	CARTRIDGE	Troubleshooting for electrical systems.
 ST22771AA030	22771AA030	SELECT MONITOR KIT	Troubleshooting for electrical systems. <ul style="list-style-type: none"> • English: 22771AA030 (Without printer) • German: 22771AA070 (Without printer) • French: 22771AA080 (Without printer) • Spanish: 22771AA090 (Without printer)

2. GENERAL PURPOSE TOOLS

TOOL NAME	REMARKS
Circuit Tester	Used for measuring resistance, voltage and ampere.
Oscilloscope	Used for measuring sensor.

ELECTRICAL COMPONENTS LOCATION

ABS (DIAGNOSTICS)

4. Electrical Components Location

A: LOCATION

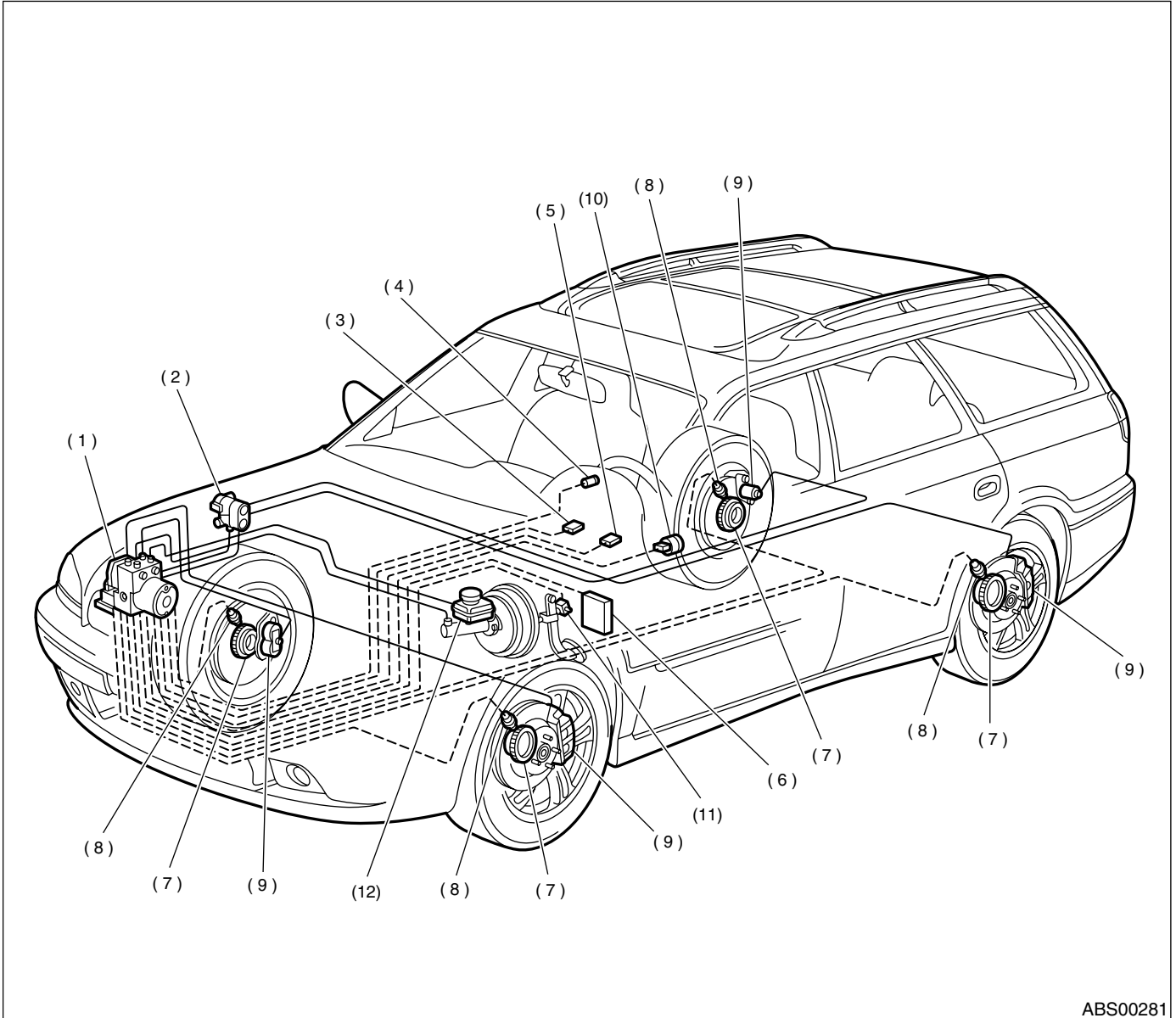

ABS00281

- (1) ABS control module and hydraulic control unit (ABSCM&H/U)
- (2) Proportioning valve
- (3) Diagnosis connector
- (4) ABS warning light

- (5) Data link connector (for Subaru select monitor)
- (6) Transmission control module (AT models)
- (7) Tone wheel

- (8) ABS sensor
- (9) Wheel cylinder
- (10) G sensor
- (11) Stop light switch
- (12) Master cylinder

ELECTRICAL COMPONENTS LOCATION

ABS (DIAGNOSTICS)

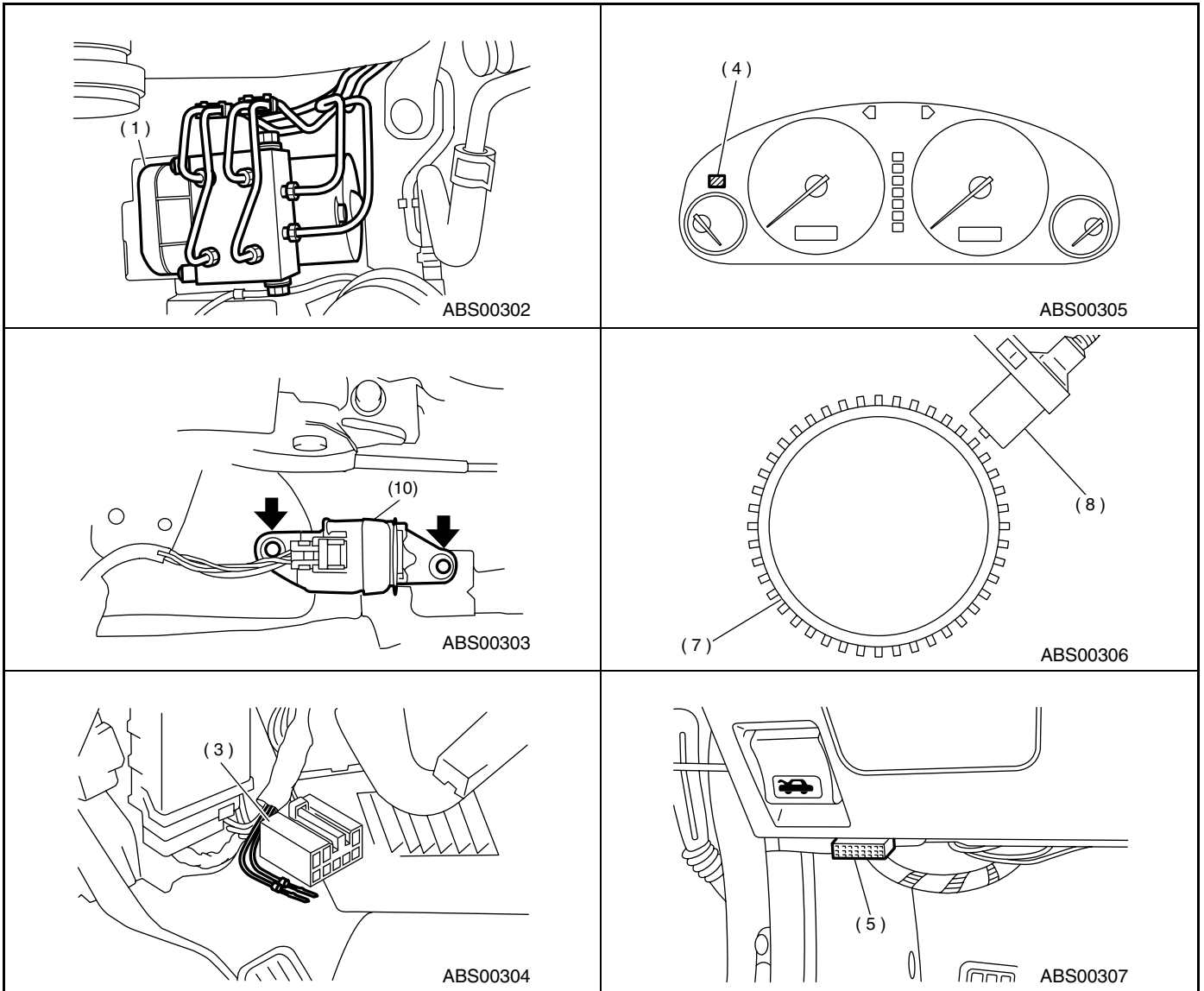

CONTROL MODULE I/O SIGNAL

ABS (DIAGNOSTICS)

5. Control Module I/O Signal

A: ELECTRICAL SPECIFICATION

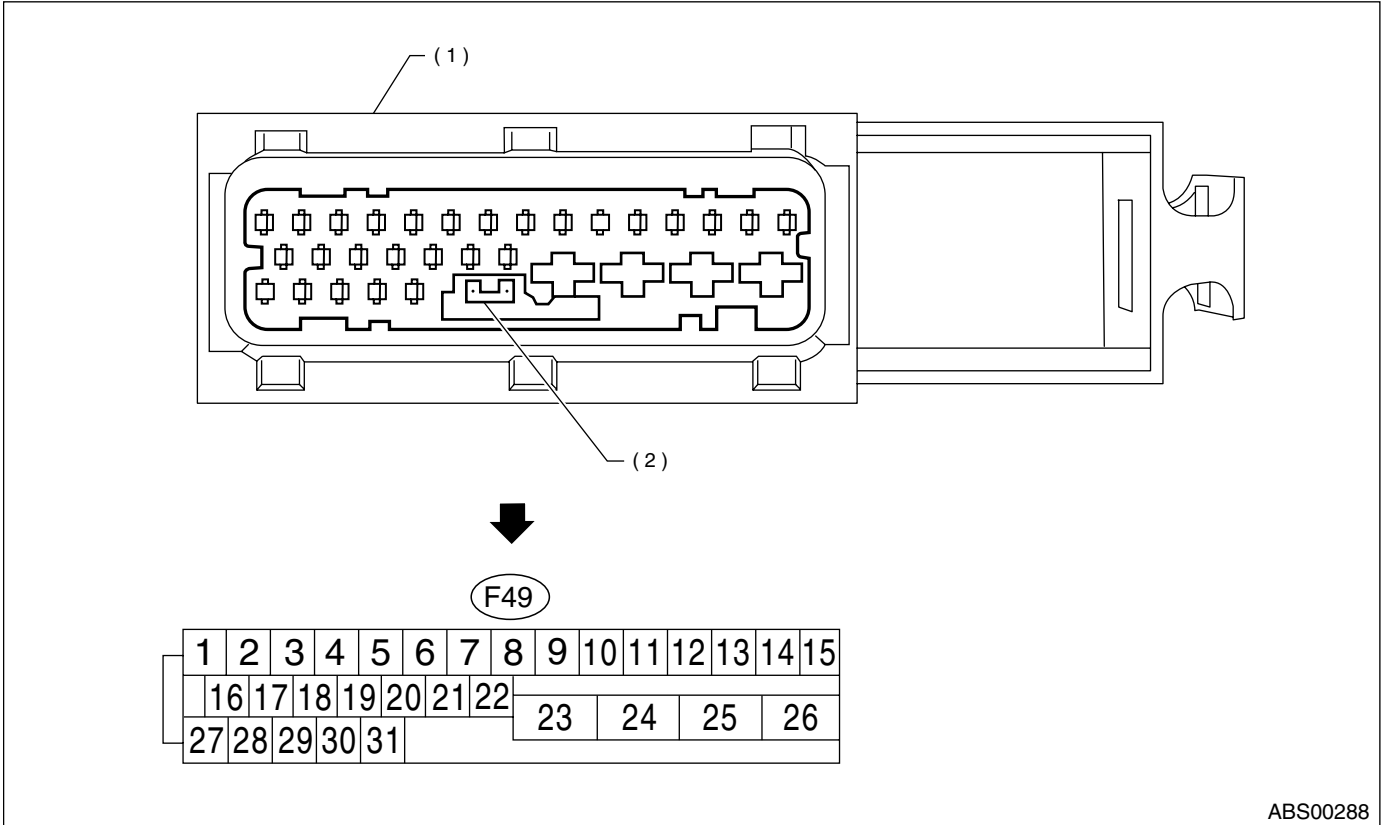

ABS00288

- (1) ABSCM&HU connector
- (2) Connector switch

NOTE:

- The terminal numbers in the ABS control module and hydraulic control unit connector are as shown in the figure.
- When the connector is removed from the ABSCM&H/U, the connector switch closes the circuit between terminal No. 22 and No. 23. The ABS warning light illuminates.

CONTROL MODULE I/O SIGNAL

ABS (DIAGNOSTICS)

Contents		Terminal No. (+)-(-)	Input/Output signal
			Measured value and measuring conditions
ABS sensor*2 (Wheel speed sensor)	Front left wheel	9—10	0.12 — 1 V (When it is 20 Hz.)
	Front right wheel	11—12	
	Rear left wheel	7—8	
	Rear right wheel	14—15	
Valve relay power supply		24—23	10 — 15 V
Motor relay power supply		25—23	10 — 15 V
G sensor*2	power supply	30—28	4.75 — 5.25 V
	ground	28	—
	output	6—28	2.3±0.2 V when vehicle is in horizontal position.
Stop light switch*1		2—23	Less than 1.5 V when the stop light is OFF and, 10 — 15 V when the stop light is ON.
ABS warning light*2		22—23	Less than 1.5 V during 1.5 seconds when ignition switch is ON, and 10 — 15 V after 1.5 seconds.
AT ABS signal*2 (AT model only)		31—23	Less than 1.5 V when the ABS control still operates and more than 5.5 V when ABS does not operate.
ABS operation signal monitor*2		3—23	Less than 1.5 V when the ABS control still operates and more than 5.5 V when ABS does not operate.
Select monitor*2	Data is received.	20—23	Less than 1.5 V when no data is received.
	Data is sent.	5—23	4.75 — 5.25 V when no data is sent.
ABS diagnosis connector*2	Terminal No. 3	29—23	10 — 15 V when ignition switch is ON.
	Terminal No. 6	4—23	10 — 15 V when ignition switch is ON.
Power supply*1		1—23	10 — 15 V when ignition switch is ON.
Grounding line		23	—
Grounding line		26	—

*1: Measure the I/O signal voltage after removing the connector from the ABSCM&H/U terminal.

*2: Measure the I/O signal voltage at connector (B62) or (F55).

CONTROL MODULE I/O SIGNAL

ABS (DIAGNOSTICS)

B: SCHEMATIC

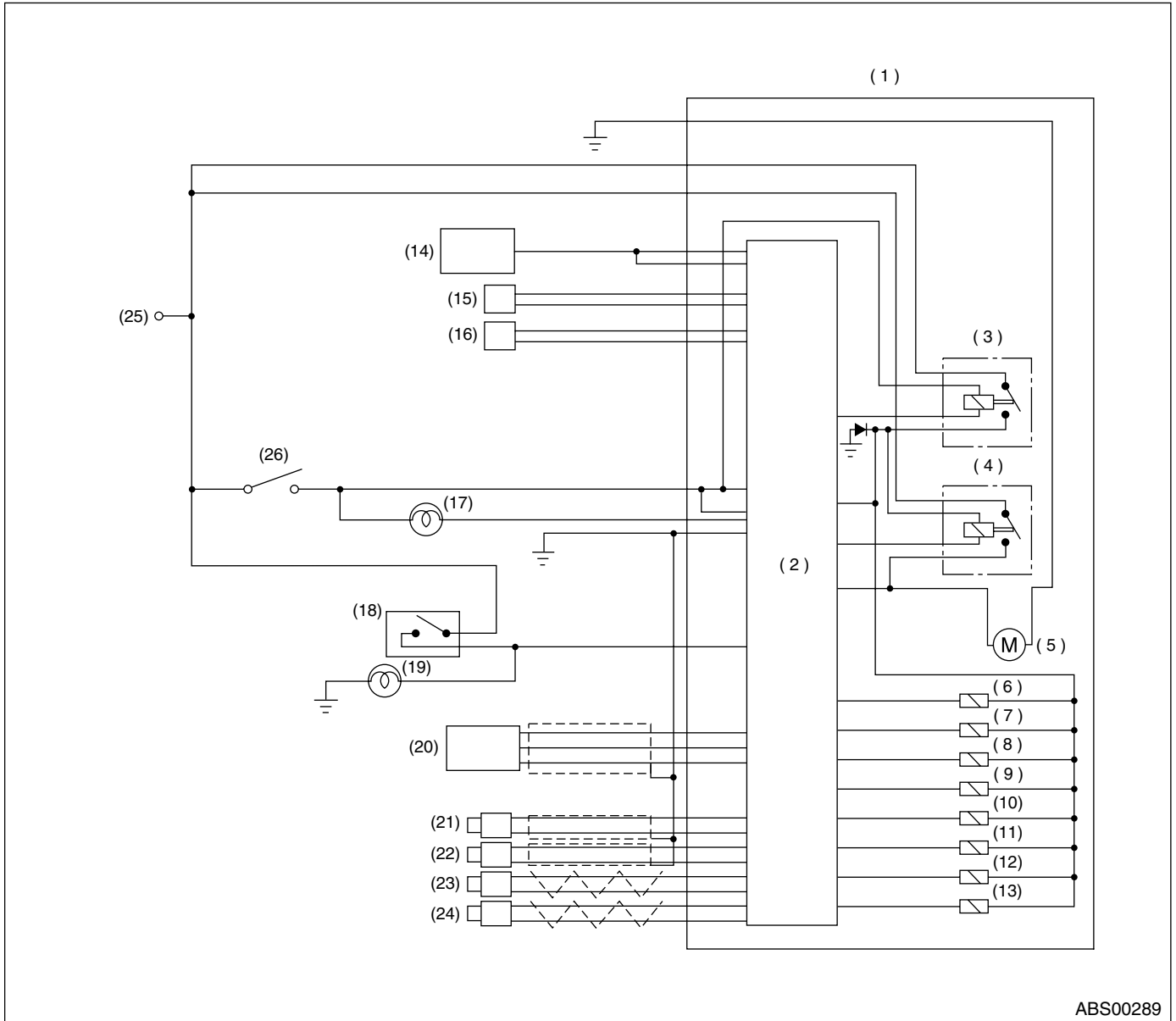

ABS00289

- | | | |
|---|--|-----------------------------|
| (1) ABS control module and hydraulic control unit (ABSCM&H/U) | (10) Rear left inlet solenoid valve | (18) Stop light switch |
| (2) ABS control module area | (11) Rear left outlet solenoid valve | (19) Stop light |
| (3) Valve relay | (12) Rear right inlet solenoid valve | (20) G sensor |
| (4) Motor relay | (13) Rear right outlet solenoid valve | (21) Front left ABS sensor |
| (5) Motor | (14) Transmission control module (only AT model) | (22) Front right ABS sensor |
| (6) Front left inlet solenoid valve | (15) Diagnosis connector | (23) Rear left ABS sensor |
| (7) Front left outlet solenoid valve | (16) Data link connector | (24) Rear right ABS sensor |
| (8) Front right inlet solenoid valve | (17) ABS warning light | (25) Battery |
| (9) Front right outlet solenoid valve | | (26) IGN |

C: WAVEFORM

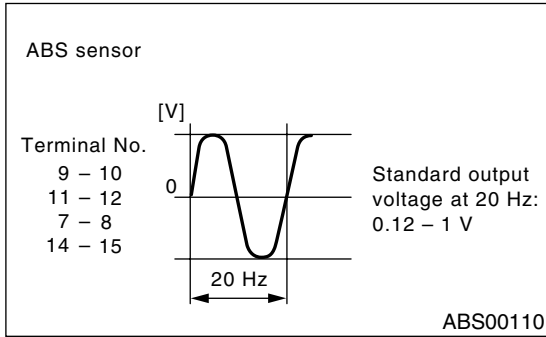

SUBARU SELECT MONITOR

ABS (DIAGNOSTICS)

6. Subaru Select Monitor

A: OPERATION

1. READ DIAGNOSTIC TROUBLE CODE (DTC)

1) Prepare Subaru Select Monitor kit.

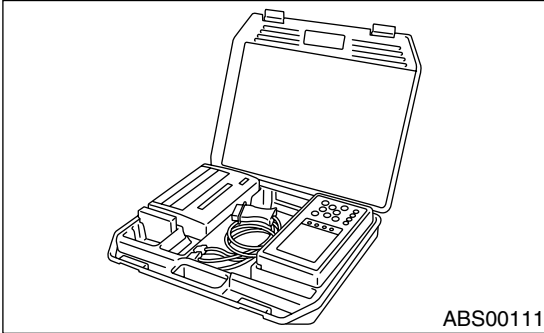

2) Connect diagnosis cable to Subaru Select Monitor.

3) Insert cartridge into Subaru Select Monitor. <Ref. to ABS-9, SPECIAL TOOLS, PREPARATION TOOL, General Description.>

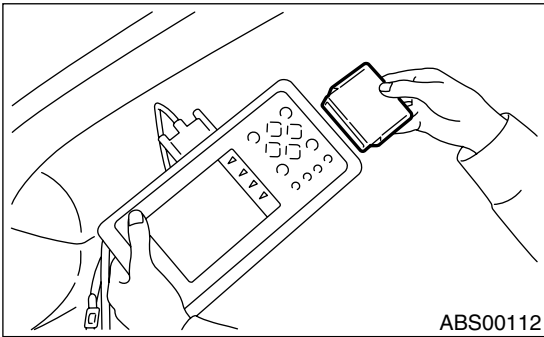

4) Connect Subaru Select Monitor to data link connector.

(1) Data link connector located in the lower portion of the instrument panel (on the driver's side).

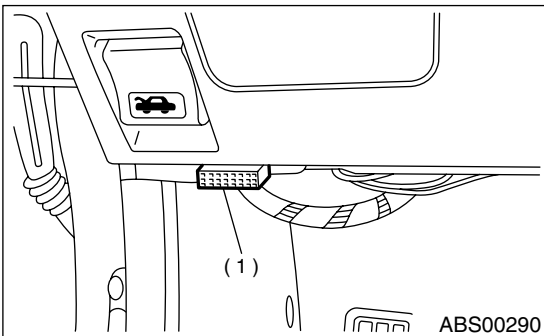

(1) Data link connector

(2) Connect diagnosis cable to data link connector.

5) Turn ignition switch to ON (engine OFF) and Subaru Select Monitor switch to ON.

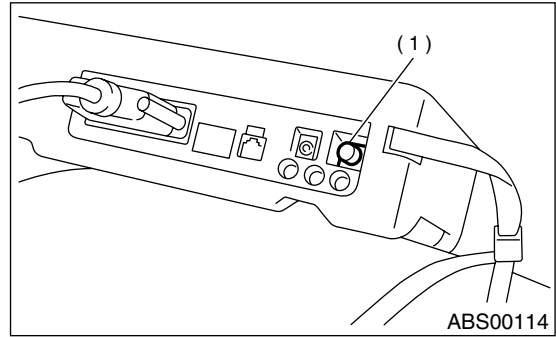

(1) Power switch

6) On the «Main Menu» display screen, select the {Each System Check} and press the [YES] key.

7) On the «System Selection Menu» display screen, select the {Brake Control System} and press the [YES] key.

8) Press the [YES] key after displayed the information of ABS type.

9) On the «ABS Diagnosis» display screen, select the {Diagnostic Code(s) Display} and press the [YES] key.

10) On the «Diagnostic Code(s) Display» display screen, select the {Current Diagnostic Code(s)} or {History Diagnostic Code(s)} and press the [YES] key.

NOTE:

- For detailed operation procedure, refer to the SUBARU SELECT MONITOR OPERATION MANUAL.
- For detailed concerning diagnostic trouble codes, refer to the LIST OF DIAGNOSTICS TROUBLE CODE. <Ref. to ABS-24, List of Diagnostics Trouble Code (DTC).>
- A maximum of 3 DTC are displayed in order of occurrence.
- If a particular DTC is not properly stored in memory (due to a drop in ABSCM&H/U power supply, etc.) when a problem occurs, the DTC, followed by a question mark "?", appears on the select monitor display. This shows it may be an unreliable reading.

Display screen	Contents to be monitored
Latest	The most recent trouble code appears on the select monitor display.
Old	The second most recent trouble code appears on the select monitor display.
Older	The third most recent trouble code appears on the select monitor display.
Reference	A specified period of time preceding trouble code appears on the select monitor display.

2. READ CURRENT DATA

- 1) On the «Main Menu» display screen, select the {Each System Check} and press the «YES» key.
 - 2) On the «System Selection Menu» display screen, select the {Brake Control System} and press the «YES» key.
 - 3) Press the «YES» key after displayed the information of ABS type.
 - 4) On the «Brake Control Diagnosis» display screen, select the {Current Data Display & Save} and press the «YES» key.
 - 5) On the «Data Display Menu» display screen, select the {Data Display} and press the «YES» key.
 - 6) Using the scroll key, move the display screen up or down until the desired data is shown.
- A list of the support data is shown in the following table.

Display screen	Contents to be monitored	Unit of measure
FR Wheel Speed	Wheel speed detected by the Front Right ABS sensor is displayed	km/h or MPH
FL Wheel Speed	Wheel speed detected by the Front Left ABS sensor is displayed	km/h or MPH
RR Wheel Speed	Wheel speed detected by the Rear Right ABS sensor is displayed	km/h or MPH
RL Wheel Speed	Wheel speed detected by the Rear Left ABS sensor is displayed	km/h or MPH
Stop Light Switch	Stop light switch signal	ON or OFF
Stop Light Switch	Stop light switch monitor voltage is displayed.	V
G sensor output Signal	Refers to vehicle acceleration detecting by the analog G sensor. It appears on the select monitor display in volts.	V
Valve Relay Signal	Valve Relay Signal	ON or OFF
Motor Relay Signal	Motor Relay Signal	ON or OFF
ABS Signal to TCM	ABS operation signal from ABS control module to TCM	ON or OFF
ABS Warning Lamp	ON operation of the ABS warning light is displayed.	ON or OFF
Motor Relay Monitor	Operating condition of the motor relay is displayed.	ON or OFF
Valve Relay Monitor	Operating condition of the valve relay is displayed.	ON or OFF
CCM Signal	ABS operation signal from ABS control module to TCM	ON or OFF

NOTE:

For detailed operation procedure, refer to the SUBARU SELECT MONITOR OPERATION MANUAL.

3. CLEAR MEMORY MODE

- 1) On the «Main Menu» display screen, select the {2. Each System Check} and press the «YES» key.
- 2) On the «System Select Menu» display screen, select {Brake System} and press the «YES» key.
- 3) Press the «YES» key after displayed the information of ABS type.
- 4) On the «Brake Control Diagnosis» display screen, select the {Clear Memory} and press the «YES» key.

Display screen	Contents to be monitored
Clear memory?	Function of clearing trouble code.

- 5) When the “Done” and “turn ignition switch OFF” are shown on the display screen, turn the Subaru Select Monitor and ignition switch to OFF.

NOTE:

For detailed operation procedure, refer to the SUBARU SELECT MONITOR OPERATION MANUAL.

4. ABS SEQUENCE CONTROL

Display screen	Contents to be monitored	Index No.
ABS sequence control	Perform ABS sequence control by operating valve and pump motor sequentially.	<Ref. to ABS-9, ABS Sequence Control.>

SUBARU SELECT MONITOR

ABS (DIAGNOSTICS)

5. FREEZE FRAME DATA

NOTE:

- Data stored at the time of trouble occurrence is shown on display.
- Each time trouble occurs, the latest information is stored in the freeze frame data in memory.
- If freeze frame data is not properly stored in memory (due to a drop in ABSCM power supply, etc.), a DTC, preceded by a question mark “?”, appears on the select monitor display. This shows it may be an unreliable reading.
- In case of no trouble code, the initial value of freeze frame data will be displayed.

Display screen	Contents to be monitored	Initial value
FR wheel speed	Wheel speed detected by the Front Right ABS sensor is displayed in km/h or mile/h.	255 km/h [158 mile/h]
FL wheel speed	Wheel speed detected by the Front Left ABS sensor is displayed in km/h or mile/h.	↑
RR wheel speed	Wheel speed detected by the Rear Right ABS sensor is displayed in km/h or mile/h.	↑
RL wheel speed	Wheel speed detected by the Rear Left ABS sensor is displayed in km/h or mile/h.	↑
ABSCM power voltage	Power (in volts) supplied to ABSCM&H/U appears on the select monitor display.	18 V
G sensor output voltage	Refers to vehicle acceleration detected by the analog G sensor. It appears on the select monitor display in volts.	5 V
Motor relay monitor	Motor relay operation monitor signal	ON
Stop light switch	Stop light switch signal	OFF
ABS signal to TCM	ABS operation signal from ABS control module to TCM	OFF
ABS-AT control	ABS operation signal from ABS control module to TCM	OFF
ABS operation signal	ABS operation signal	ON

6. ANALOG DATA ARE DISPLAYED.

Display screen	Contents to be monitored
FR wheel speed	Wheel speed detected by the Front Right ABS sensor is displayed in km/h or mile/h.
FL wheel speed	Wheel speed detected by the Front Left ABS sensor is displayed in km/h or mile/h.
RR wheel speed	Wheel speed detected by the Rear Right ABS sensor is displayed in km/h or mile/h.
RL wheel speed	Wheel speed detected by the Rear Left ABS sensor is displayed in km/h or mile/h.
Stop light switch	Stop light switch monitor voltage is displayed.
G sensor output voltage	Refers to vehicle acceleration detecting by the analog G sensor. It appears on the select monitor display in volts.

7. ON/OFF DATA ARE DISPLAYED.

Display screen	Contents to be monitored
Stop light switch	Stop light switch signal
Valve relay signal	Valve relay signal
Motor relay signal	Motor relay signal
ABS signal to TCM	ABS operation signal from ABS control module to TCM
ABS warning light	ABS warning light
Valve relay monitor	Valve relay operation monitor signal
Motor relay monitor	Motor relay operation monitor signal
CCM signal	ABS operation signal from ABS control module to TCM

7. Read Diagnostic Trouble Code (DTC)

A: OPERATION

1. WITHOUT SUBARU SELECT MONITOR

1) Take out diagnosis connector from side of driver's seat heater unit.

- 2) Turn ignition switch OFF.
- 3) Connect diagnosis connector terminal 8 to diagnosis terminal.
- 4) Turn ignition switch ON.
- 5) ABS warning light is set in the diagnostic mode and blinks to identify diagnostic trouble code (DTC).

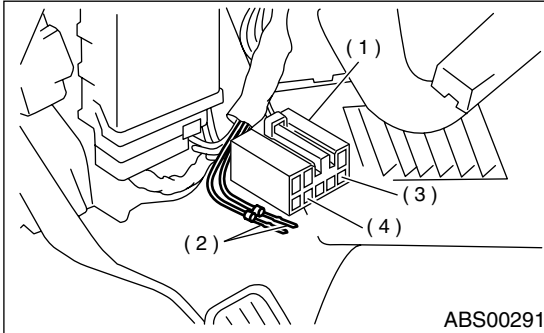

- (1) Diagnosis connector
- (2) Diagnosis terminal
- (3) 8 terminal
- (4) 5 terminal

6) After the start code (11) is shown, the diagnostic trouble codes (DTC) will be shown in order of the last information first.

These repeat for a maximum of 3 minutes.

NOTE:

- When there are no diagnostic trouble codes (DTC) in memory, only the start code (11) is shown.
- When on-board diagnosis of the ABS control module detects a problem, the information (up to a maximum of three) will be stored in the EEPROM as a diagnostic trouble code (DTC). When there are more than three, the most recent three will be stored. (Stored codes will stay in memory until they are cleared.)

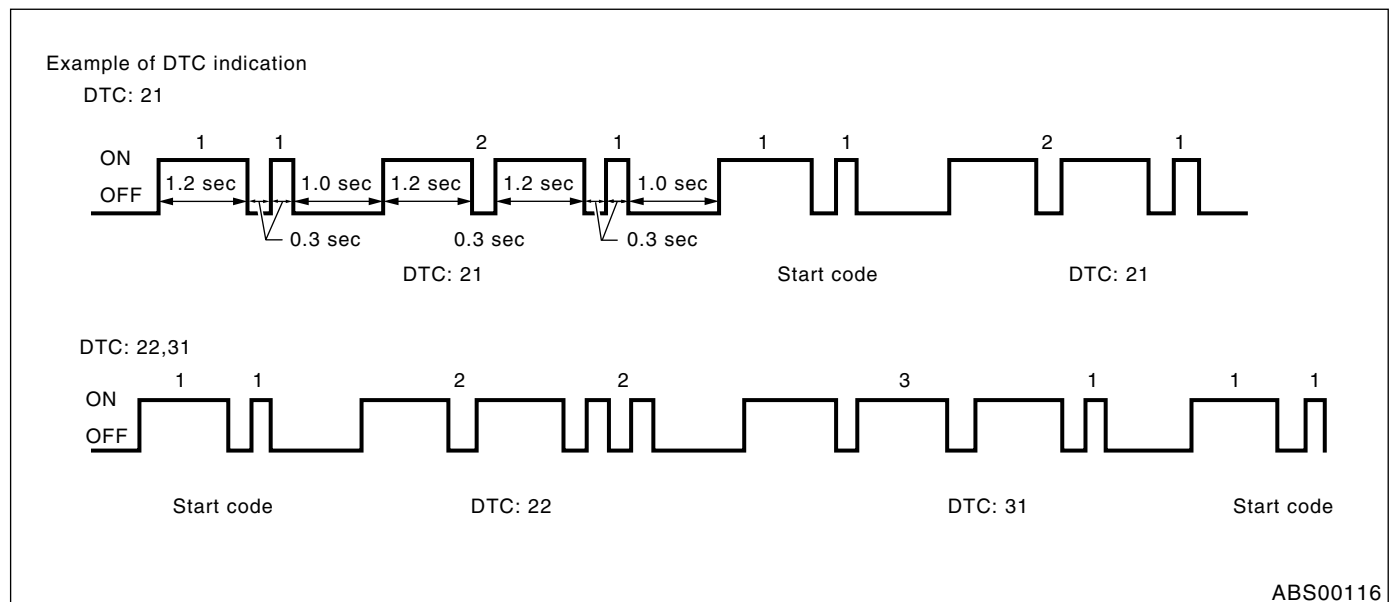

READ DIAGNOSTIC TROUBLE CODE (DTC)

ABS (DIAGNOSTICS)

2. WITH SUBARU SELECT MONITOR

Refer to SUBARU SELECT MONITOR for information about how to obtain and understand diagnostic trouble codes (DTC). <Ref. to ABS-16, Subaru Select Monitor.>

8. Inspection Mode

A: OPERATION

Reproduce the condition under which the problem has occurred as much as possible.

Drive the vehicle at a speed more than 40 km/h (25 MPH) for at least one minute.

CLEAR MEMORY MODE

ABS (DIAGNOSTICS)

9. Clear Memory Mode

A: OPERATION

1. WITHOUT SUBARU SELECT MONITOR

1) After calling up a diagnostic trouble code (DTC), disconnect diagnosis connector terminal 8 from diagnosis terminal.

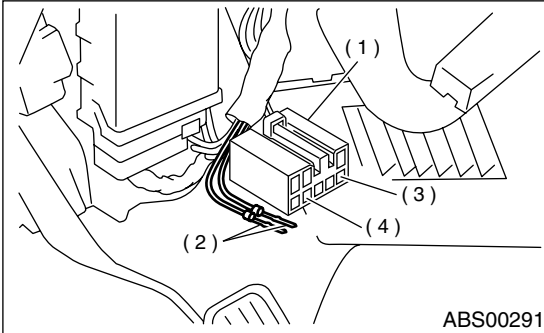

- (1) Diagnosis connector
- (2) Diagnosis terminal
- (3) 8 terminal
- (4) 5 terminal

2) Repeat 3 times within approx. 12 seconds; connecting and disconnecting terminal 8 and diagnosis terminal for at least 0.2 seconds each time.

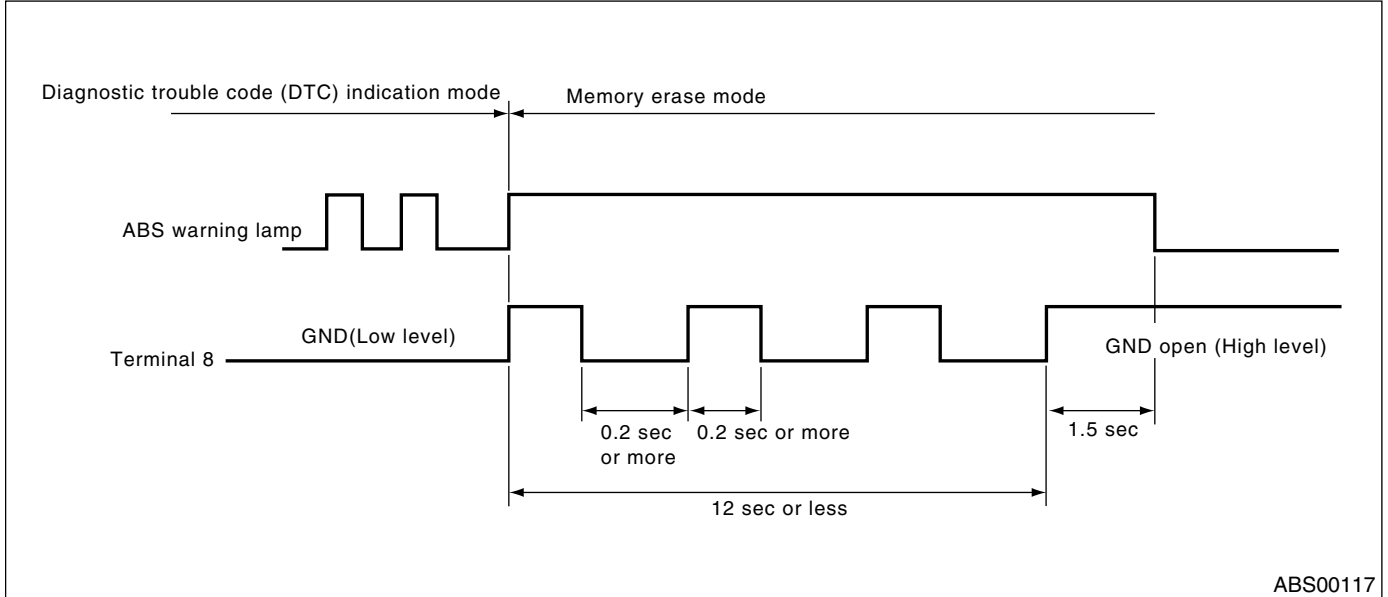

NOTE:

After diagnostics is completed, make sure to clear memory. Make sure only start code (11) is shown after memory is cleared.

2. WITH SUBARU SELECT MONITOR

Refer to SUBARU SELECT MONITOR for information about how to clear diagnostic trouble codes (DTC).
<Ref. to ABS-16, Subaru Select Monitor.>

10.ABS Warning Light Illumination Pattern

A: INSPECTION

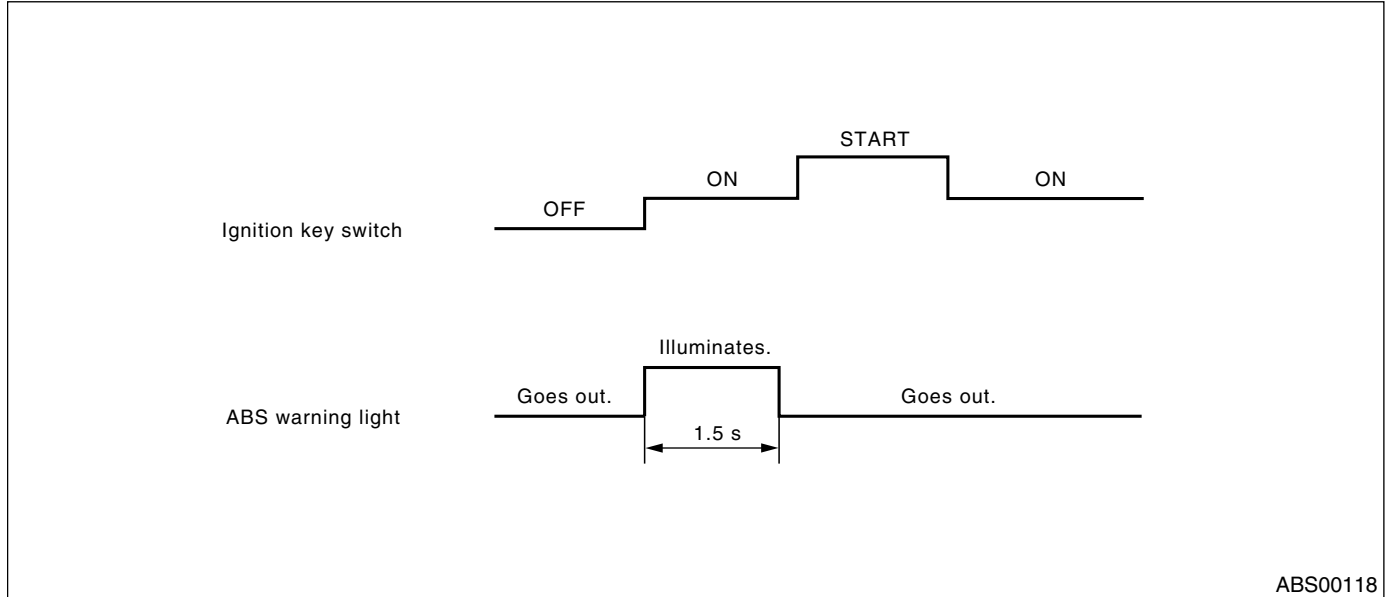

1) When the ABS warning light does not illuminate in accordance with this illumination pattern, there must be an electrical malfunction.

2) When the ABS warning light remains constantly OFF, repair the ABS warning light circuit or diagnosis circuit. <Ref. to ABS-28, Diagnostics Chart with Diagnosis Connector.>

NOTE:

Even though the ABS warning light does not go out 1.5 seconds after it illuminates, the ABS system operates normally when the warning light goes out while driving at approximately 12 km/h (7 MPH). However, the Anti-lock brakes do not work while the ABS warning light is illuminated.

LIST OF DIAGNOSTICS TROUBLE CODE (DTC)

ABS (DIAGNOSTICS)

11. List of Diagnostics Trouble Code (DTC)

A: LIST

1. WITHOUT SUBARU SELECT MONITOR

DTC No.	Contents of diagnosis		Index No.
11	Start code • DTC is shown after start code. • Only start code is shown in normal condition.		—
21	Abnormal ABS sensor (Open circuit or input voltage too high)	Front right ABS sensor	<Ref. to ABS-38, DTC 21 ABNORMAL ABS SENSOR (OPEN CIRCUIT OR INPUT VOLTAGE TOO HIGH) (FRONT RH), Diagnostics Chart with Diagnosis Connector.>
23		Front left ABS sensor	<Ref. to ABS-38, DTC 23 ABNORMAL ABS SENSOR (OPEN CIRCUIT OR INPUT VOLTAGE TOO HIGH) (FRONT LH), Diagnostics Chart with Diagnosis Connector.>
25		Rear right ABS sensor	<Ref. to ABS-38, DTC 25 ABNORMAL ABS SENSOR (OPEN CIRCUIT OR INPUT VOLTAGE TOO HIGH) (REAR RH), Diagnostics Chart with Diagnosis Connector.>
27		Rear left ABS sensor	<Ref. to ABS-40, DTC 27 ABNORMAL ABS SENSOR (OPEN CIRCUIT OR INPUT VOLTAGE TOO HIGH) (REAR LH), Diagnostics Chart with Diagnosis Connector.>
22	Abnormal ABS sensor (Abnormal ABS sensor signal)	Front right ABS sensor	<Ref. to ABS-44, DTC 22 ABNORMAL ABS SENSOR (FRONT RH), Diagnostics Chart with Diagnosis Connector.>
24		Front left ABS sensor	<Ref. to ABS-44, DTC 24 ABNORMAL ABS SENSOR (FRONT LH), Diagnostics Chart with Diagnosis Connector.>
26		Rear right ABS sensor	<Ref. to ABS-44, DTC 26 ABNORMAL ABS SENSOR (REAR RH), Diagnostics Chart with Diagnosis Connector.>
28		Rear left ABS sensor	<Ref. to ABS-46, DTC 28 ABNORMAL ABS SENSOR (REAR LH), Diagnostics Chart with Diagnosis Connector.>
29		Any one of four	<Ref. to ABS-50, DTC 29 ABNORMAL ABS SENSOR SIGNAL (ANY ONE OF FOUR), Diagnostics Chart with Diagnosis Connector.>
31	Abnormal solenoid valve circuit(s) in ABS control module and hydraulic unit	Front right inlet valve	<Ref. to ABS-53, DTC 31 ABNORMAL INLET SOLENOID VALVE CIRCUIT(S) IN ABSCM&H/U (FRONT RH), Diagnostics Chart with Diagnosis Connector.>
32		Front right outlet valve	<Ref. to ABS-56, DTC 32 ABNORMAL OUTLET SOLENOID VALVE CIRCUIT(S) IN ABSCM&H/U (FRONT RH), Diagnostics Chart with Diagnosis Connector.>
33		Front left inlet valve	<Ref. to ABS-53, DTC 33 ABNORMAL INLET SOLENOID VALVE CIRCUIT(S) IN ABSCM&H/U (FRONT LH), Diagnostics Chart with Diagnosis Connector.>
34		Front left outlet valve	<Ref. to ABS-56, DTC 34 ABNORMAL OUTLET SOLENOID VALVE CIRCUIT(S) IN ABSCM&H/U (FRONT LH), Diagnostics Chart with Diagnosis Connector.>
35		Rear right inlet valve	<Ref. to ABS-53, DTC 35 ABNORMAL INLET SOLENOID VALVE CIRCUIT(S) IN ABSCM&H/U (REAR RH), Diagnostics Chart with Diagnosis Connector.>
36		Rear right outlet valve	<Ref. to ABS-56, DTC 36 ABNORMAL OUTLET SOLENOID VALVE CIRCUIT(S) IN ABSCM&H/U (REAR RH), Diagnostics Chart with Diagnosis Connector.>
37		Rear left inlet valve	<Ref. to ABS-54, DTC 37 ABNORMAL INLET SOLENOID VALVE CIRCUIT(S) IN ABSCM&H/U (REAR LH), Diagnostics Chart with Diagnosis Connector.>
38		Rear left outlet valve	<Ref. to ABS-58, DTC 38 ABNORMAL OUTLET SOLENOID VALVE CIRCUIT(S) IN ABSCM&H/U (REAR LH), Diagnostics Chart with Diagnosis Connector.>

LIST OF DIAGNOSTICS TROUBLE CODE (DTC)

ABS (DIAGNOSTICS)

DTC No.	Contents of diagnosis	Index No.
41	Abnormal ABS control module	<Ref. to ABS-60, DTC 41 ABNORMAL ABS CONTROL MODULE, Diagnostics Chart with Diagnosis Connector.>
42	Source voltage is abnormal.	<Ref. to ABS-62, DTC 42 SOURCE VOLTAGE IS ABNORMAL., Diagnostics Chart with Diagnosis Connector.>
44	A combination of AT control abnormal	<Ref. to ABS-64, DTC 44 A COMBINATION OF AT CONTROL ABNORMAL, Diagnostics Chart with Diagnosis Connector.>
51	Abnormal valve relay	<Ref. to ABS-68, DTC 51 ABNORMAL VALVE RELAY, Diagnostics Chart with Diagnosis Connector.>
52	Abnormal motor and/or motor relay	<Ref. to ABS-70, DTC 52 ABNORMAL MOTOR AND/OR MOTOR RELAY, Diagnostics Chart with Diagnosis Connector.>
54	Abnormal stop light switch	<Ref. to ABS-72, DTC 54 ABNORMAL STOP LIGHT SWITCH, Diagnostics Chart with Diagnosis Connector.>
56	Abnormal G sensor output voltage	<Ref. to ABS-74, DTC 56 ABNORMAL G SENSOR OUTPUT VOLTAGE, Diagnostics Chart with Diagnosis Connector.>

2. WITH SUBARU SELECT MONITOR

DTC No.	Display screen	Contents of diagnosis	Index No.
—	Communication for initializing impossible	Select monitor communication failure	<Ref. to ABS-78, COMMUNICATION FOR INITIALIZING IMPOSSIBLE, Diagnostics Chart with Subaru Select Monitor.>
—	No trouble code	Although no diagnostic trouble code appears on the select monitor display, the ABS warning light remains on.	<Ref. to ABS-81, NO TROUBLE CODE, Diagnostics Chart with Subaru Select Monitor.>
21	Open or short circuit in front right ABS sensor circuit	Open or short circuit in front right ABS sensor circuit	<Ref. to ABS-84, DTC 21 OPEN OR SHORT CIRCUIT IN FRONT RIGHT ABS SENSOR CIRCUIT, Diagnostics Chart with Subaru Select Monitor.>
22	Front right ABS sensor abnormal signal	Front right ABS sensor abnormal signal	<Ref. to ABS-91, DTC 22 FRONT RIGHT ABNORMAL ABS SENSOR SIGNAL, Diagnostics Chart with Subaru Select Monitor.>
23	Open or short circuit in front left ABS sensor circuit	Open or short circuit in front left ABS sensor circuit	<Ref. to ABS-84, DTC 23 OPEN OR SHORT CIRCUIT IN FRONT LEFT ABS SENSOR CIRCUIT, Diagnostics Chart with Subaru Select Monitor.>
24	Front left ABS sensor abnormal signal	Front left ABS sensor abnormal signal	<Ref. to ABS-91, DTC 24 FRONT LEFT ABNORMAL ABS SENSOR SIGNAL, Diagnostics Chart with Subaru Select Monitor.>
25	Open or short circuit in rear right ABS sensor circuit	Open or short circuit in rear right ABS sensor circuit	<Ref. to ABS-84, DTC 25 OPEN OR SHORT CIRCUIT IN REAR RIGHT ABS SENSOR CIRCUIT, Diagnostics Chart with Subaru Select Monitor.>
26	Rear right ABS sensor abnormal signal	Rear right ABS sensor abnormal signal	<Ref. to ABS-91, DTC 26 REAR RIGHT ABNORMAL ABS SENSOR SIGNAL, Diagnostics Chart with Subaru Select Monitor.>
27	Open or short circuit in rear left ABS sensor circuit	Open or short circuit in rear left ABS sensor circuit	<Ref. to ABS-86, DTC 27 OPEN OR SHORT CIRCUIT IN REAR LEFT ABS SENSOR CIRCUIT, Diagnostics Chart with Subaru Select Monitor.>
28	Rear left ABS sensor abnormal signal	Rear left ABS sensor abnormal signal	<Ref. to ABS-92, DTC 28 REAR LEFT ABNORMAL ABS SENSOR SIGNAL, Diagnostics Chart with Subaru Select Monitor.>
29	Abnormal ABS sensor signal on any one of four sensor	Abnormal ABS sensor signal on any one of four	<Ref. to ABS-98, DTC 29 ABNORMAL ABS SENSOR SIGNAL ON ANY ONE OF FOUR SENSOR, Diagnostics Chart with Subaru Select Monitor.>
31	Front right inlet valve malfunction	Front right inlet valve malfunction	<Ref. to ABS-101, DTC 31 FRONT RIGHT INLET VALVE MALFUNCTION, Diagnostics Chart with Subaru Select Monitor.>
32	Front right outlet valve malfunction	Front right outlet valve malfunction	<Ref. to ABS-104, DTC 32 FRONT RIGHT OUTLET VALVE MALFUNCTION, Diagnostics Chart with Subaru Select Monitor.>

LIST OF DIAGNOSTICS TROUBLE CODE (DTC)

ABS (DIAGNOSTICS)

DTC No.	Display screen	Contents of diagnosis	Index No.
33	Front left inlet valve malfunction	Front left inlet valve malfunction	<Ref. to ABS-101, DTC 33 FRONT LEFT INLET VALVE MALFUNCTION, Diagnostics Chart with Subaru Select Monitor.>
34	Front left outlet valve malfunction	Front left outlet valve malfunction	<Ref. to ABS-104, DTC 34 FRONT LEFT OUTLET VALVE MALFUNCTION, Diagnostics Chart with Subaru Select Monitor.>
35	Rear right inlet valve malfunction	Rear right inlet valve malfunction	<Ref. to ABS-101, DTC 35 REAR RIGHT INLET VALVE MALFUNCTION, Diagnostics Chart with Subaru Select Monitor.>
36	Rear right outlet valve malfunction	Rear right outlet valve malfunction	<Ref. to ABS-104, DTC 36 REAR RIGHT OUTLET VALVE MALFUNCTION, Diagnostics Chart with Subaru Select Monitor.>
37	Rear left inlet valve malfunction	Rear left inlet valve malfunction	<Ref. to ABS-102, DTC 37 REAR LEFT INLET VALVE MALFUNCTION, Diagnostics Chart with Subaru Select Monitor.>
38	Rear left outlet valve malfunction	Rear left outlet valve malfunction	<Ref. to ABS-106, DTC 38 REAR LEFT OUTLET VALVE MALFUNCTION, Diagnostics Chart with Subaru Select Monitor.>
41	ABS control module malfunction	ABS control module and hydraulic control unit malfunction	<Ref. to ABS-108, DTC 41 ABS CONTROL MODULE MALFUNCTION, Diagnostics Chart with Subaru Select Monitor.>
42	Power supply voltage too low	Power supply voltage too low	<Ref. to ABS-110, DTC 42 POWER SUPPLY VOLTAGE TOO LOW, Diagnostics Chart with Subaru Select Monitor.>
42	Power supply voltage too high	Power supply voltage too high	<Ref. to ABS-112, DTC 42 POWER SUPPLY VOLTAGE TOO HIGH, Diagnostics Chart with Subaru Select Monitor.>
44	ABS-AT control (Non Controlled)	ABS-AT control (Non Controlled)	<Ref. to ABS-114, DTC 44 ABS-AT CONTROL (NON CONTROLLED), Diagnostics Chart with Subaru Select Monitor.>
44	ABS-AT control (Controlled)	ABS-AT control (Controlled)	<Ref. to ABS-116, DTC 44 ABS-AT CONTROL (CONTROLLED), Diagnostics Chart with Subaru Select Monitor.>
51	Valve relay malfunction	Valve relay malfunction	<Ref. to ABS-118, DTC 51 VALVE RELAY MALFUNCTION, Diagnostics Chart with Subaru Select Monitor.>
51	Valve relay ON failure	Valve relay ON failure	<Ref. to ABS-120, DTC 51 VALVE RELAY ON FAILURE, Diagnostics Chart with Subaru Select Monitor.>
52	Open circuit in motor relay circuit	Open circuit in motor relay circuit	<Ref. to ABS-122, DTC 52 OPEN CIRCUIT IN MOTOR RELAY CIRCUIT, Diagnostics Chart with Subaru Select Monitor.>
52	Motor relay ON failure	Motor relay ON failure	<Ref. to ABS-124, DTC 52 MOTOR RELAY ON FAILURE, Diagnostics Chart with Subaru Select Monitor.>
52	Motor malfunction	Motor malfunction	<Ref. to ABS-126, DTC 52 MOTOR MALFUNCTION, Diagnostics Chart with Subaru Select Monitor.>
54	Stop light switch signal circuit malfunction	Stop light switch signal circuit malfunction	<Ref. to ABS-128, DTC 54 STOP LIGHT SWITCH SIGNAL CIRCUIT MALFUNCTION, Diagnostics Chart with Subaru Select Monitor.>
56	Open or short circuit in G sensor circuit	Open or short circuit in G sensor circuit	<Ref. to ABS-130, DTC 56 OPEN OR SHORT CIRCUIT IN G SENSOR CIRCUIT, Diagnostics Chart with Subaru Select Monitor.>
56	Battery short in G sensor circuit	Battery short in G sensor circuit	<Ref. to ABS-134, DTC 56 BATTERY SHORT IN G SENSOR CIRCUIT, Diagnostics Chart with Subaru Select Monitor.>
56	Abnormal G sensor high μ output	Abnormal G sensor high μ output	<Ref. to ABS-126, DTC 56 ABNORMAL G SENSOR HIGH μ OUTPUT, Diagnostics Chart with Subaru Select Monitor.>
56	Detection of G sensor stick	Detection of G sensor stick	<Ref. to ABS-142, DTC 56 DETECTION OF G SENSOR STICK, Diagnostics Chart with Subaru Select Monitor.>

LIST OF DIAGNOSTICS TROUBLE CODE (DTC)

ABS (DIAGNOSTICS)

MEMO:

DIAGNOSTICS CHART WITH DIAGNOSIS CONNECTOR

ABS (DIAGNOSTICS)

12. Diagnostics Chart with Diagnosis Connector

A: ABS WARNING LIGHT DOES NOT COME ON.

DIAGNOSIS:

- ABS warning light circuit is open or shorted.

TROUBLE SYMPTOM:

- When ignition switch is turned ON (engine OFF), ABS warning light does not come on

WIRING DIAGRAM:

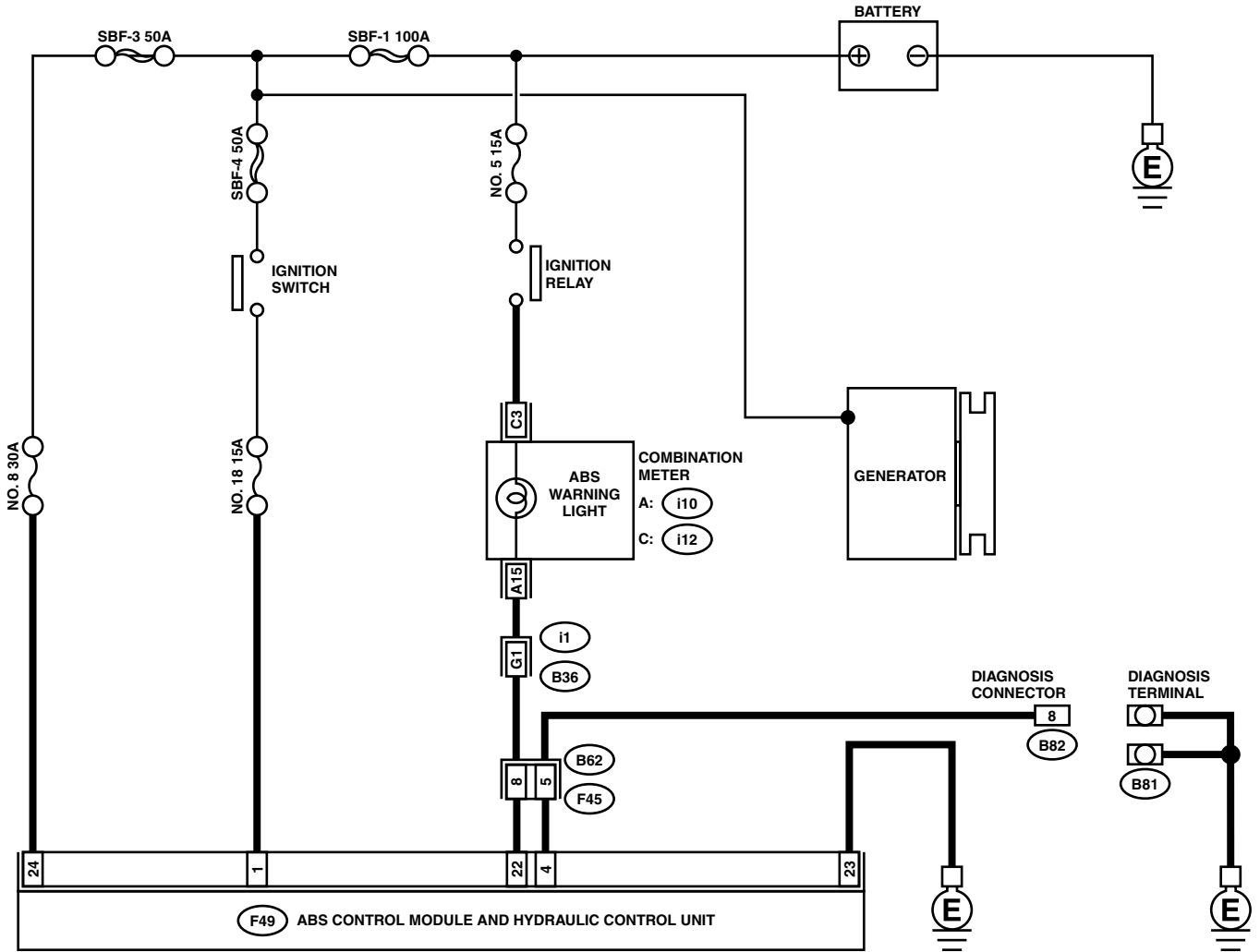

B82

1	2	3
4	5	6

i12

1	2	3	4	5	6
7	8	9	10	11	12

F45

1	2	3	4	5	6	7
8	9	10	11	12	13	14

F49

1	2	3	4	5	6	7	8	9	10	11	12	13	14	15
16	17	18	19	20	21	22	23	24	25	26				
27	28	29	30	31										

B36

A1	A2	A3	A4	A5	A6
B1	B2	B3	B4	B5	B6
C1	C2	C3	C4	C5	C6
D1	D2	D3	D4	D5	D6
E1	E2	E3	E4	E5	E6
F1	F2	F3	F4	F5	F6
G1	G2	G3	G4	G5	G6
H1	H2	H3	H4	H5	H6
I1	I2	I3	I4	I5	I6
J1	J2	J3	J4	J5	J6
K1	K2	K3	K4	K5	K6
L1	L2	L3	L4	L5	L6
M1	M2	M3	M4	M5	M6
N1	N2	N3	N4	N5	N6
O1	O2	O3	O4	O5	O6
P1	P2	P3	P4	P5	P6

i10

1	2	3	4	5	6	7	8	9	10	11	12	13	14
15	16	17	18	19	20	21	22	23	24	25	26	27	28
29	30												

ABS00425

DIAGNOSTICS CHART WITH DIAGNOSIS CONNECTOR

ABS (DIAGNOSTICS)

Step	Check	Yes	No
1 CHECK IF OTHER WARNING LIGHTS TURN ON. Turn ignition switch to ON (engine OFF).	Do other warning lights turn on?	Go to step 2.	Repair combination meter. -<Ref. to IDI-13, Combination Meter Assembly.>
2 CHECK ABS WARNING LIGHT BULB. 1) Turn ignition switch to OFF. 2) Remove combination meter. 3) Remove ABS warning light bulb from combination meter.	Is ABS warning light bulb OK?	Go to step 3.	Replace ABS warning light bulb. <Ref. to IDI-13, Combination Meter Assembly.>
3 CHECK BATTERY SHORT OF ABS WARNING LIGHT HARNESS. 1) Disconnect connector (B62) from connector (F45). 2) Measure voltage between connector (B62) and chassis ground. <i>Connector & terminal</i> <i>(B62) No. 8 (+) — Chassis ground (-):</i>	Is the measured value less than 3 V?	Go to step 4.	Repair warning light harness.
4 CHECK BATTERY SHORT OF ABS WARNING LIGHT HARNESS. 1) Turn ignition switch to ON. 2) Measure voltage between connector (B62) and chassis ground. <i>Connector & terminal</i> <i>(B62) No. 8 (+) — Chassis ground (-):</i>	Is the measured value less than 3 V?	Go to step 5.	Repair warning light harness.
5 CHECK WIRING HARNESS. 1) Turn ignition switch to OFF. 2) Install ABS warning light bulb from combination meter. 3) Install combination meter. 4) Turn ignition switch to ON. 5) Measure voltage between connector (B62) and chassis ground. <i>Connector & terminal</i> <i>(B62) No. 8 (+) — Chassis ground (-):</i>	Is the measured value within 10 to 15 V?	Go to step 6.	Repair wiring harness.
6 CHECK BATTERY SHORT OF ABS WARNING LIGHT HARNESS. 1) Turn ignition switch to OFF. 2) Measure voltage between connector (F45) and chassis ground. <i>Connector & terminal</i> <i>(F45) No. 8 (+) — Chassis ground (-):</i>	Is the measured value less than 3 V?	Go to step 7.	Repair wiring harness.
7 CHECK BATTERY SHORT OF ABS WARNING LIGHT HARNESS. 1) Turn ignition switch to ON. 2) Measure voltage between connector (F45) and chassis ground. <i>Connector & terminal</i> <i>(F45) No. 8 (+) — Chassis ground (-):</i>	Is the measured value less than 3 V?	Go to step 8.	Repair wiring harness.
8 CHECK GROUND CIRCUIT OF ABSCM&H/U. Measure resistance between ABSCM&H/U and chassis ground. <i>Connector & terminal</i> <i>(F49) No. 23 — Chassis ground:</i>	Is the measured value less than 0.5 Ω?	Go to step 9.	Repair ABSCM&H/U ground harness.
9 CHECK WIRING HARNESS. Measure resistance between connector (F45) and chassis ground. <i>Connector & terminal</i> <i>(F45) No. 8 — Chassis ground:</i>	Is the measured value less than 0.5 Ω?	Go to step 10.	Repair harness/connector.

DIAGNOSTICS CHART WITH DIAGNOSIS CONNECTOR

ABS (DIAGNOSTICS)

Step	Check	Yes	No
10	CHECK POOR CONTACT IN CONNECTORS. Turn ignition switch to OFF.	Is there poor contact in connectors between combination meter and ABSCM&H/U?	Replace ABSCM&H/U. <Ref. to ABS-6, ABS Control Module and Hydraulic Control Unit (ABSCM&H/U).>

DIAGNOSTICS CHART WITH DIAGNOSIS CONNECTOR

ABS (DIAGNOSTICS)

MEMO:

DIAGNOSTICS CHART WITH DIAGNOSIS CONNECTOR

ABS (DIAGNOSTICS)

B: ABS WARNING LIGHT DOES NOT GO OFF.

DIAGNOSIS:

- ABS warning light circuit is open or shorted.

TROUBLE SYMPTOM:

- When starting the engine and while ABS warning light is kept ON.

WIRING DIAGRAM:

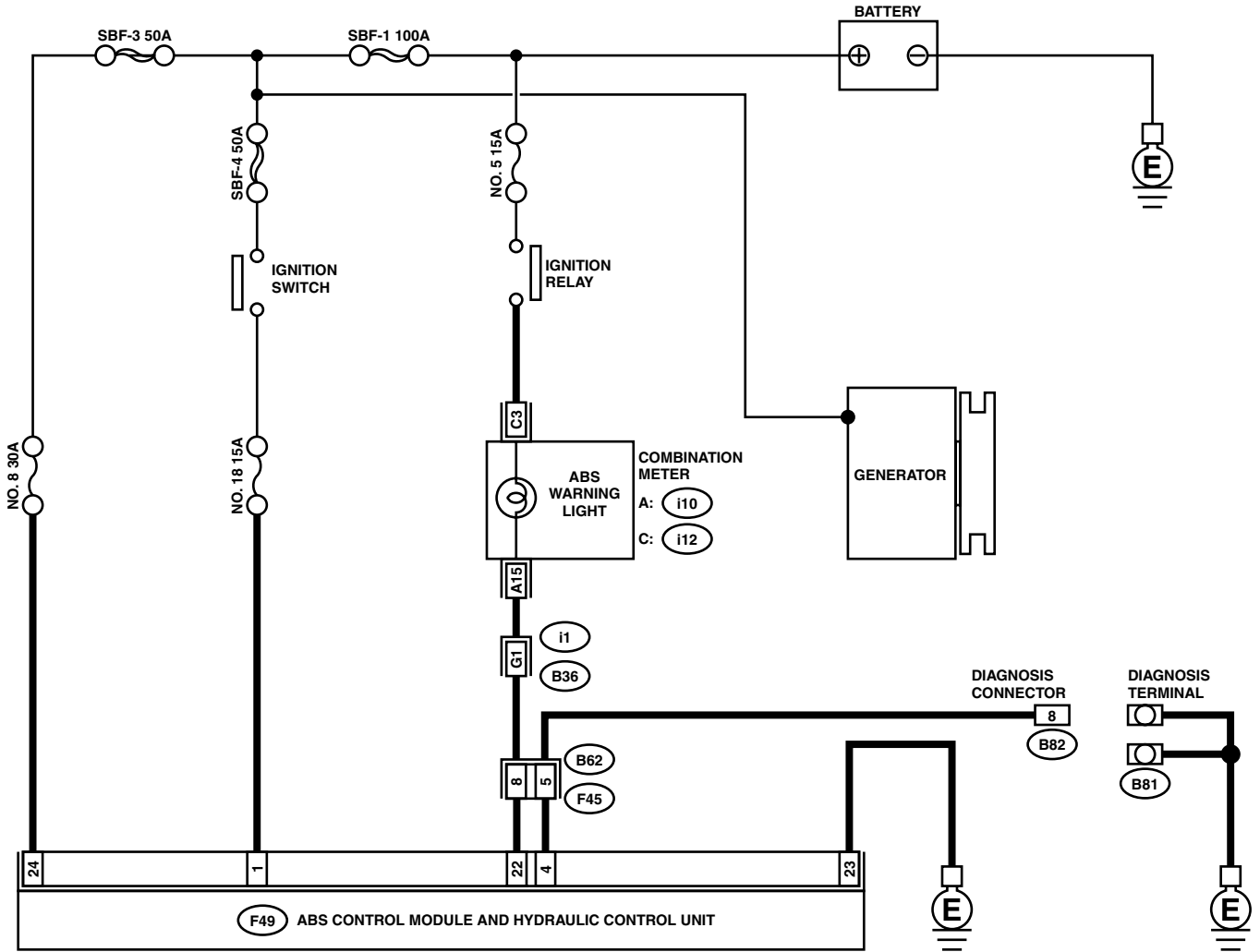

B82

1	2	3	4
5	6	7	8

i12

1	2	3	4	5	6		
7	8	9	10	11	12	13	14

F45

1	2	3	4	5	6	7		
8	9	10	11	12	13	14	15	16

F49

1	2	3	4	5	6	7	8	9	10	11	12	13	14	15
16	17	18	19	20	21	22	23	24	25	26				
27	28	29	30	31										

i10

1	2	3	4	5	6	7	8	9	10	11	12	13	14		
15	16	17	18	19	20	21	22	23	24	25	26	27	28	29	30

B36

A1	A2	A3	A4	A5	A6
B1	B2	B3	B4	B5	B6
C1	C2	C3	C4	C5	C6
D1	D2	D3	D4	D5	D6
E1	E2	E3	E4	E5	E6
F1	F2	F3	F4	F5	F6
G1	G2	G3	G4	G5	G6
H1	H2	H3	H4	H5	H6
I1	I2	I3	I4	I5	I6
J1	J2	J3	J4	J5	J6
K1	K2	K3	K4	K5	K6
L1	L2	L3	L4	L5	L6
M1	M2	M3	M4	M5	M6
N1	N2	N3	N4	N5	N6
O1	O2	O3	O4	O5	O6
P1	P2	P3	P4	P5	P6

ABS00425

DIAGNOSTICS CHART WITH DIAGNOSIS CONNECTOR

ABS (DIAGNOSTICS)

Step	Check	Yes	No
1 CHECK INSTALLATION OF ABSCM&H/U CONNECTOR. Turn ignition switch to OFF.	Is ABSCM&H/U connector inserted into ABSCM until the clamp locks onto it?	Go to step 2.	Insert ABSCM&H/U connector into ABSCM&H/U until the clamp locks onto it.
2 CHECK DIAGNOSIS TERMINAL. Measure resistance between diagnosis terminals (B81) and chassis ground. <i>Terminals</i> <i>Diagnosis terminal (A) — Chassis ground:</i> <i>Diagnosis terminal (B) — Chassis ground:</i>	Is the measured value less than 0.5 Ω?	Go to step 3.	Repair diagnosis terminal harness.
3 CHECK DIAGNOSIS LINE. 1) Turn ignition switch to OFF. 2) Connect diagnosis terminal (B81) to diagnosis connector (B82) No. 8. 3) Disconnect connector from ABSCM&H/U. 4) Measure resistance between ABSCM&H/U connector and chassis ground. <i>Connector & terminal</i> <i>(F49) No. 4 — Chassis ground:</i>	Is the measured value less than 0.5 Ω?	Go to step 4.	Repair harness connector between ABSCM&H/U and diagnosis connector.
4 CHECK GENERATOR. 1) Start the engine. 2) Idle the engine. 3) Measure voltage between generator and chassis ground. <i>Terminal</i> <i>Generator B terminal (+) — Chassis ground (-):</i>	Is the measured value within 10 to 15 V?	Go to step 5.	Repair generator. H4 engine model: <Ref. to SC(H4SO)-15, Generator.> H6 engine model: <Ref. to SC(H6DO)-14, Generator.>
5 CHECK BATTERY TERMINAL. Turn ignition switch to OFF.	Is there poor contact at battery terminal?	Repair battery terminal.	Go to step 6.
6 CHECK POWER SUPPLY OF ABSCM. 1) Disconnect connector from ABSCM&H/U. 2) Start engine. 3) Idle the engine. 4) Measure voltage between ABSCM&H/U connector and chassis ground. <i>Connector & terminal</i> <i>(F49) No. 1 (+) — Chassis ground (-):</i>	Is the measured value within 10 to 15 V?	Go to step 7.	Repair ABSCM&H/U power supply circuit.
7 CHECK WIRING HARNESS. 1) Disconnect connector (F45) from connector (B62). 2) Turn ignition switch to ON.	Does the ABS warning light turn on?	Repair front wiring harness.	Go to step 8.
8 CHECK ABSCM&H/U TERMINAL. 1) Turn ignition switch to OFF. 2) Check for damage at the ABSCM&H/U terminal.	Is there any damage on terminal?	Replace ABSCM&H/U. <Ref. to ABS-6, ABS Control Module and Hydraulic Control Unit (ABSCM&H/U).>	Go to step 9.
9 CHECK ABSCM&H/U. Measure resistance between ABSCM&H/U terminals. <i>Terminal</i> <i>No. 22 — No. 23:</i>	Is the measured value more than 1 MΩ?	Go to step 10.	Replace ABSCM&H/U. <Ref. to ABS-6, ABS Control Module and Hydraulic Control Unit (ABSCM&H/U).>

DIAGNOSTICS CHART WITH DIAGNOSIS CONNECTOR

ABS (DIAGNOSTICS)

Step	Check	Yes	No
10 CHECK WIRING HARNESS. Measure resistance between connector (F45) and chassis ground. <i>Connector & terminal</i> <i>(F45) No. 8 — Chassis ground:</i>	Is the measured value less than 0.5 Ω ?	Go to step 11 .	Repair harness.
11 CHECK WIRING HARNESS. 1) Connect connector to ABSCM&H/U. 2) Measure resistance between connector (F45) and chassis ground. <i>Connector & terminal</i> <i>(F45) No. 8 — Chassis ground:</i>	Is the measured value more than 1 M Ω ?	Go to step 12 .	Repair harness.
12 CHECK POOR CONTACT IN ABSCM&H/U CONNECTOR.	Is there poor contact in ABSCM&H/U connector?	Repair connector.	Replace ABSCM&H/U. <Ref. to ABS-6, ABS Control Module and Hydraulic Control Unit (ABSCM&H/U).>

DIAGNOSTICS CHART WITH DIAGNOSIS CONNECTOR

ABS (DIAGNOSTICS)

MEMO:

DIAGNOSTICS CHART WITH DIAGNOSIS CONNECTOR

ABS (DIAGNOSTICS)

C: DIAGNOSTIC TROUBLE CODE (DTC) DOES NOT APPEAR.

DIAGNOSIS:

- Diagnosis circuit is open.

TROUBLE SYMPTOM:

- The ABS warning light turns on or off normally but the start code cannot be read out in the diagnostic mode.

WIRING DIAGRAM:

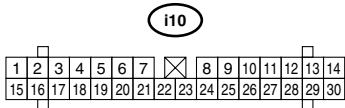
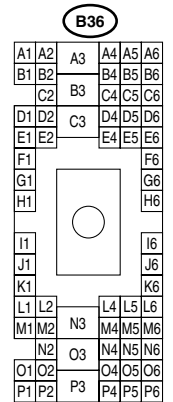
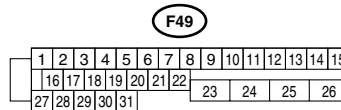
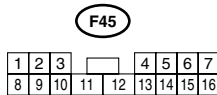
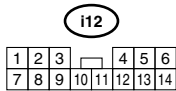
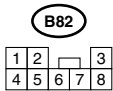
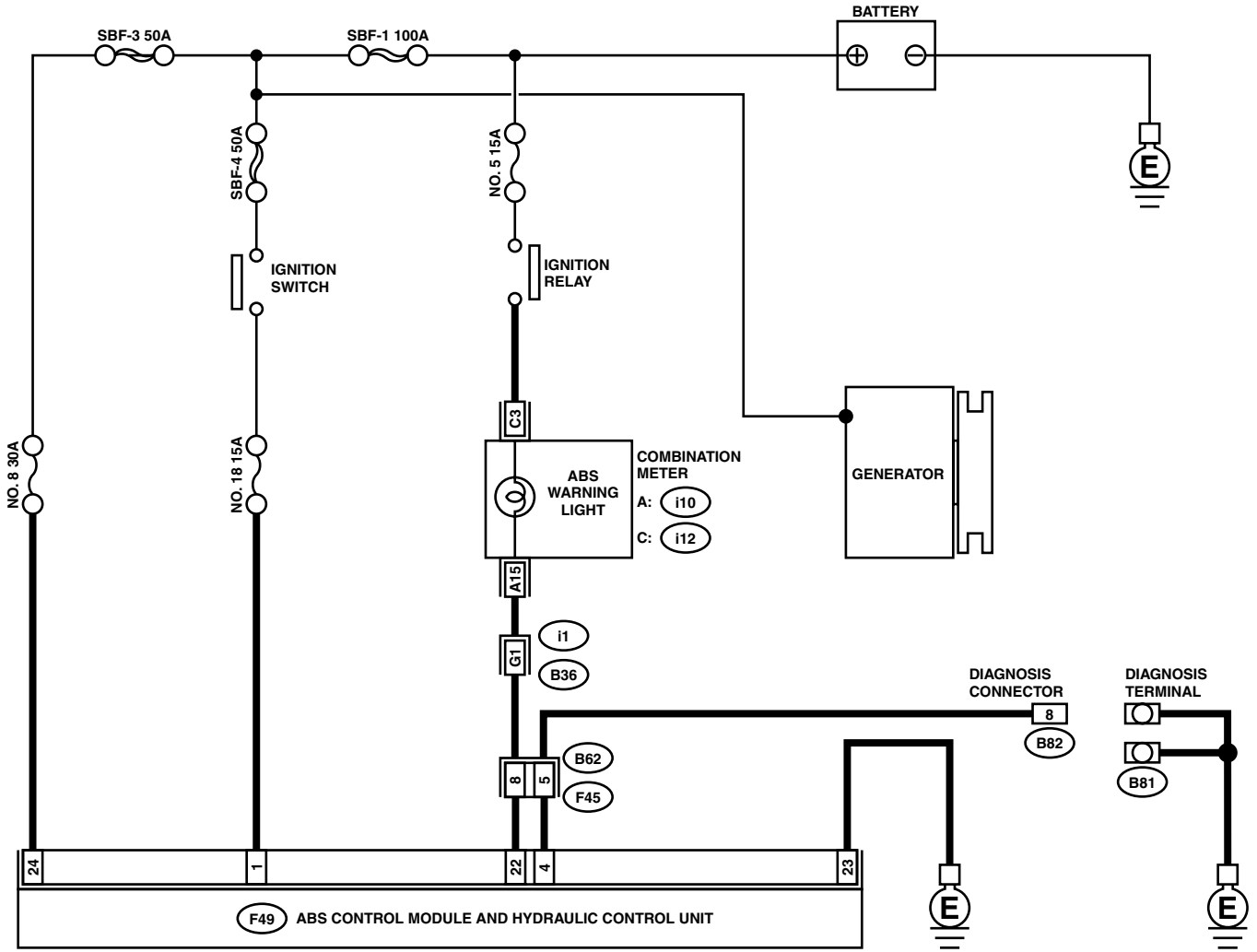

ABS00425

DIAGNOSTICS CHART WITH DIAGNOSIS CONNECTOR

ABS (DIAGNOSTICS)

Step	Check	Yes	No
1 CHECK DIAGNOSIS TERMINAL. 1) Turn ignition switch to OFF. 2) Measure resistance between diagnosis terminals (B81) and chassis ground. Terminals <i>Diagnosis terminal (A) — Chassis ground:</i> <i>Diagnosis terminal (B) — Chassis ground:</i>	Is the measured value less than 0.5 Ω?	Go to step 2.	Repair diagnosis terminal harness.
2 CHECK DIAGNOSIS LINE. 1) Turn ignition switch to OFF. 2) Connect diagnosis terminal (B81) to diagnosis connector (B82) No. 8. 3) Disconnect connector from ABSCM&H/U. 4) Measure resistance between ABSCM&H/U connector and chassis ground. Connector & terminal <i>(F49) No. 4 — Chassis ground:</i>	Is the measured value less than 0.5 Ω?	Go to step 3.	Repair harness connector between ABSCM&H/U and diagnosis connector.
3 CHECK POOR CONTACT IN ABSCM&H/U CONNECTOR.	Is there poor contact in ABSCM&H/U connector?	Replace ABSCM&H/U. <Ref. to ABS-6, ABS Control Module and Hydraulic Control Unit (ABSCM&H/U).>	Repair connector.

DIAGNOSTICS CHART WITH DIAGNOSIS CONNECTOR

ABS (DIAGNOSTICS)

D: DTC 21 ABNORMAL ABS SENSOR (OPEN CIRCUIT OR INPUT VOLTAGE TOO HIGH) (FRONT RH)

NOTE:

For the diagnostic procedure, refer to DTC 27. <Ref. to ABS-40, DTC 27 ABNORMAL ABS SENSOR (OPEN CIRCUIT OR INPUT VOLTAGE TOO HIGH) (REAR LH), Diagnostics Chart with Diagnosis Connector.>

E: DTC 23 ABNORMAL ABS SENSOR (OPEN CIRCUIT OR INPUT VOLTAGE TOO HIGH) (FRONT LH)

NOTE:

For the diagnostic procedure, refer to DTC 27. <Ref. to ABS-40, DTC 27 ABNORMAL ABS SENSOR (OPEN CIRCUIT OR INPUT VOLTAGE TOO HIGH) (REAR LH), Diagnostics Chart with Diagnosis Connector.>

F: DTC 25 ABNORMAL ABS SENSOR (OPEN CIRCUIT OR INPUT VOLTAGE TOO HIGH) (REAR RH)

NOTE:

For the diagnostic procedure, refer to DTC 27. <Ref. to ABS-40, DTC 27 ABNORMAL ABS SENSOR (OPEN CIRCUIT OR INPUT VOLTAGE TOO HIGH) (REAR LH), Diagnostics Chart with Diagnosis Connector.>

DIAGNOSTICS CHART WITH DIAGNOSIS CONNECTOR

ABS (DIAGNOSTICS)

MEMO:

DIAGNOSTICS CHART WITH DIAGNOSIS CONNECTOR

ABS (DIAGNOSTICS)

G: DTC 27 ABNORMAL ABS SENSOR (OPEN CIRCUIT OR INPUT VOLTAGE TOO HIGH) (REAR LH)

DIAGNOSIS:

- Faulty ABS sensor (Broken wire, input voltage too high)
- Faulty harness connector

TROUBLE SYMPTOM:

- ABS does not operate.

WIRING DIAGRAM:

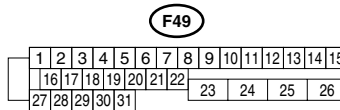
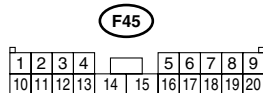
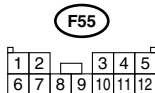
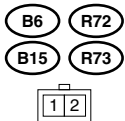
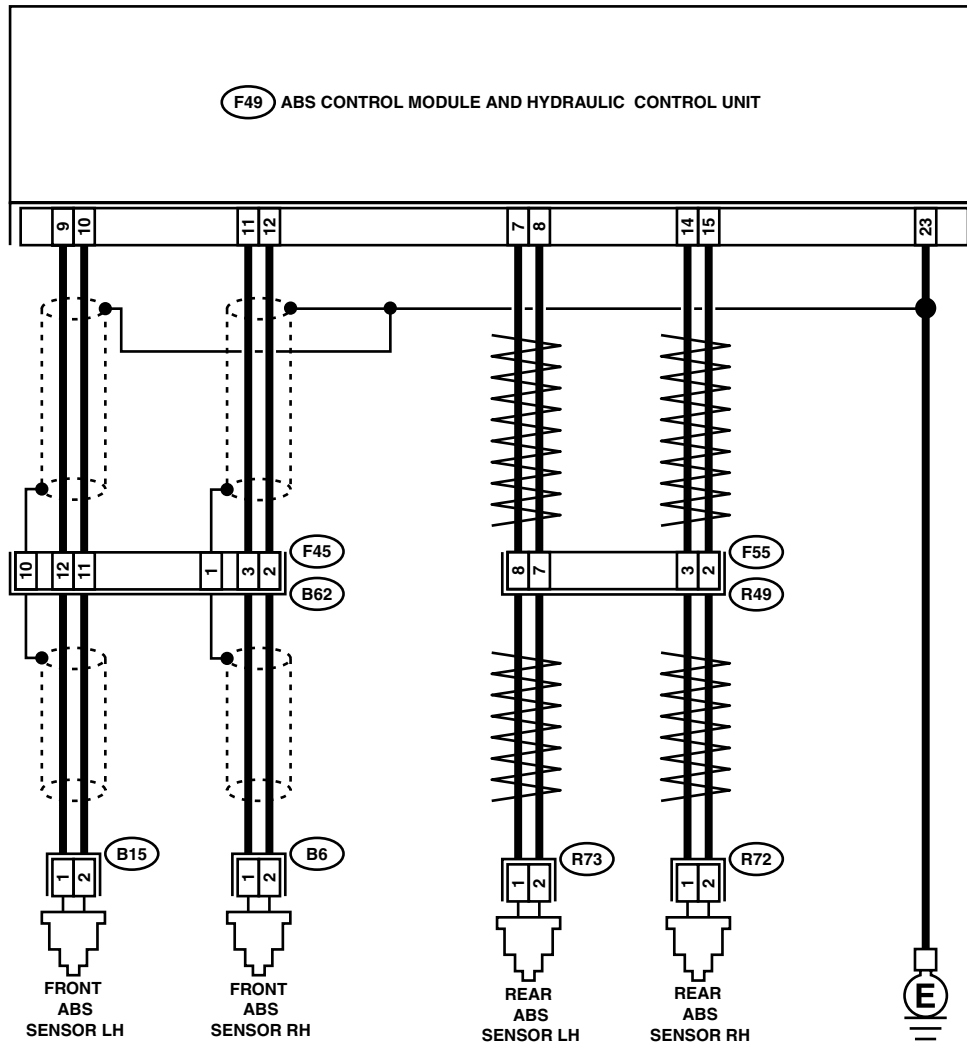

DIAGNOSTICS CHART WITH DIAGNOSIS CONNECTOR

ABS (DIAGNOSTICS)

Step	Check	Yes	No
<p>1 CHECK ABS SENSOR. 1) Turn ignition switch to OFF. 2) Disconnect connector from ABS sensor. 3) Measure resistance of ABS sensor connector terminals.</p> <p>Terminal <i>Front RH No. 1 — No. 2:</i> <i>Front LH No. 1 — No. 2:</i> <i>Rear RH No. 1 — No. 2:</i> <i>Rear LH No. 1 — No. 2:</i></p>	Is the measured value within 1 to 1.5 kΩ?	Go to step 2.	Replace ABS sensor. Front: <Ref. to ABS-12, Front ABS Sensor.> Rear: <Ref. to ABS-15, Rear ABS Sensor.>
<p>2 CHECK BATTERY SHORT OF ABS SENSOR. 1) Disconnect connector from ABSCM&H/U. 2) Measure voltage between ABS sensor and chassis ground.</p> <p>Terminal <i>Front RH No. 1 (+) — Chassis ground (-):</i> <i>Front LH No. 1 (+) — Chassis ground (-):</i> <i>Rear RH No. 1 (+) — Chassis ground (-):</i> <i>Rear LH No. 1 (+) — Chassis ground (-):</i></p>	Is the measured value less than 1 V?	Go to step 3.	Replace ABS sensor. Front: <Ref. to ABS-12, Front ABS Sensor.> Rear: <Ref. to ABS-15, Rear ABS Sensor.>
<p>3 CHECK BATTERY SHORT OF ABS SENSOR. 1) Turn ignition switch to ON. 2) Measure voltage between ABS sensor and chassis ground.</p> <p>Terminal <i>Front RH No. 1 (+) — Chassis ground (-):</i> <i>Front LH No. 1 (+) — Chassis ground (-):</i> <i>Rear RH No. 1 (+) — Chassis ground (-):</i> <i>Rear LH No. 1 (+) — Chassis ground (-):</i></p>	Is the measured value less than 1 V?	Go to step 4.	Replace ABS sensor. Front: <Ref. to ABS-12, Front ABS Sensor.> Rear: <Ref. to ABS-15, Rear ABS Sensor.>
<p>4 CHECK HARNESS/CONNECTOR BETWEEN ABSCM&H/U AND ABS SENSOR. 1) Turn ignition switch to OFF. 2) Connect connector to ABS sensor. 3) Measure resistance between ABSCM&H/U connector terminals.</p> <p>Connector & terminal <i>DTC 21 / (F49) No. 11 — No. 12:</i> <i>DTC 23 / (F49) No. 9 — No. 10:</i> <i>DTC 25 / (F49) No. 14 — No. 15:</i> <i>DTC 27 / (F49) No. 7 — No. 8:</i></p>	Is the measured value within 1 to 1.5 kΩ?	Go to step 5.	Repair harness/connector between ABSCM&H/U and ABS sensor.

DIAGNOSTICS CHART WITH DIAGNOSIS CONNECTOR

ABS (DIAGNOSTICS)

Step	Check	Yes	No
5 CHECK BATTERY SHORT OF HARNESS. Measure voltage between ABSCM&H/U connector and chassis ground. Connector & terminal <i>DTC 21 / (F49) No. 11 (+) — Chassis ground (-):</i> <i>DTC 23 / (F49) No. 9 (+) — Chassis ground (-):</i> <i>DTC 25 / (F49) No. 14 (+) — Chassis ground (-):</i> <i>DTC 27 / (F49) No. 7 (+) — Chassis ground (-):</i>	Is the measured value less than 1 V?	Go to step 6.	Repair harness between ABSCM&H/U and ABS sensor.
6 CHECK BATTERY SHORT OF HARNESS. 1) Turn ignition switch to ON. 2) Measure voltage between ABSCM&H/U connector and chassis ground. Connector & terminal <i>DTC 21 / (F49) No. 11 (+) — Chassis ground (-):</i> <i>DTC 23 / (F49) No. 9 (+) — Chassis ground (-):</i> <i>DTC 25 / (F49) No. 14 (+) — Chassis ground (-):</i> <i>DTC 27 / (F49) No. 7 (+) — Chassis ground (-):</i>	Is the measured value less than 1 V?	Go to step 7.	Repair harness between ABSCM&H/U and ABS sensor.
7 CHECK INSTALLATION OF ABS SENSOR. Turn ignition switch to OFF.	Are the ABS sensor installation bolts tightened to 33 N·m (3.4 kgf·m, 25 ft·lb)?	Go to step 8.	Tighten ABS sensor installation bolts securely.
8 CHECK ABS SENSOR GAP. Measure tone wheel to ABS sensor piece gap over entire perimeter of the wheel.	Is the measured value within the range indicated below? Front wheel 0.3 — 0.8 mm (0.012 — 0.031 in) and Rear wheel 0.44 — 0.94 mm (0.0173 — 0.0370 in)	Go to step 9.	Adjust the gap. NOTE: Adjust the gap using spacers (Part No. 26755AA000). If spacers cannot correct the gap, replace worn sensor or worn tone wheel.
9 CHECK TONE WHEEL RUNOUT. Measure tone wheel runout.	Is the measured value less than 0.05 mm (0.0020 in)?	Go to step 10.	Replace tone wheel. Front: <Ref. to ABS-19, Front Tone Wheel.> Rear: <Ref. to ABS-20, Rear Tone Wheel.>
10 CHECK GROUND SHORT OF ABS SENSOR. 1) Turn ignition switch to ON. 2) Measure resistance between ABS sensor and chassis ground. Terminal <i>Front RH No. 1 — Chassis ground:</i> <i>Front LH No. 1 — Chassis ground:</i> <i>Rear RH No. 1 — Chassis ground:</i> <i>Rear LH No. 1 — Chassis ground:</i>	Is the measured value more than 1 MΩ?	Go to step 11.	Replace ABS sensor and ABSCM&H/U. Front: <Ref. to ABS-12, Front ABS Sensor.> Rear: <Ref. to ABS-15, Rear ABS Sensor.> and <Ref. to ABS-6, ABS Control Module and Hydraulic Control Unit (ABSCM&H/U).>

DIAGNOSTICS CHART WITH DIAGNOSIS CONNECTOR

ABS (DIAGNOSTICS)

Step	Check	Yes	No
11 CHECK GROUND SHORT OF HARNESS. 1) Turn ignition switch to OFF. 2) Connect connector to ABS sensor. 3) Measure resistance between ABSCM&H/U connector terminal and chassis ground. Connector & terminal <i>DTC 21 / (F49) No. 11 — Chassis ground:</i> <i>DTC 23 / (F49) No. 9 — Chassis ground:</i> <i>DTC 25 / (F49) No. 14 — Chassis ground:</i> <i>DTC 27 / (F49) No. 7 — Chassis ground:</i>	Is the measured value more than 1 MΩ?	Go to step 12.	Repair harness between ABSCM&H/U and ABS sensor. Replace ABSCM&H/U. <Ref. to ABS-6, ABS Control Module and Hydraulic Control Unit (ABSCM&H/U).>
12 CHECK POOR CONTACT IN CONNECTORS.	Is there poor contact in connectors between ABSCM&H/U and ABS sensor?	Repair connector.	Go to step 13.
13 CHECK ABSCM&H/U. 1) Connect all connectors. 2) Erase the memory. 3) Perform inspection mode. 4) Read out the DTC.	Is the same DTC still being output?	Replace ABSCM&H/U. <Ref. to ABS-6, ABS Control Module and Hydraulic Control Unit (ABSCM&H/U).>	Go to step 14.
14 CHECK ANY OTHER DTC APPEARANCE.	Are other DTC being output?	Proceed with the diagnosis corresponding to the DTC.	A temporary poor contact. NOTE: Check harness and connectors between ABSCM&H/U and ABS sensor.

DIAGNOSTICS CHART WITH DIAGNOSIS CONNECTOR

ABS (DIAGNOSTICS)

H: DTC 22 ABNORMAL ABS SENSOR (FRONT RH)

NOTE:

For the diagnostic procedure, refer to DTC 28. <Ref. to ABS-46, DTC 28 ABNORMAL ABS SENSOR (REAR LH), Diagnostics Chart with Diagnosis Connector.>

I: DTC 24 ABNORMAL ABS SENSOR (FRONT LH)

NOTE:

For the diagnostic procedure, refer to DTC 28. <Ref. to ABS-46, DTC 28 ABNORMAL ABS SENSOR (REAR LH), Diagnostics Chart with Diagnosis Connector.>

J: DTC 26 ABNORMAL ABS SENSOR (REAR RH)

NOTE:

For the diagnostic procedure, refer to DTC 28. <Ref. to ABS-46, DTC 28 ABNORMAL ABS SENSOR (REAR LH), Diagnostics Chart with Diagnosis Connector.>

DIAGNOSTICS CHART WITH DIAGNOSIS CONNECTOR

ABS (DIAGNOSTICS)

MEMO:

DIAGNOSTICS CHART WITH DIAGNOSIS CONNECTOR

ABS (DIAGNOSTICS)

K: DTC 28 ABNORMAL ABS SENSOR (REAR LH)

DIAGNOSIS:

- Faulty ABS sensor signal (noise, irregular signal, etc.)
- Faulty harness/connector

TROUBLE SYMPTOM:

- ABS does not operate.

WIRING DIAGRAM:

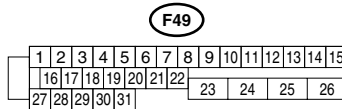
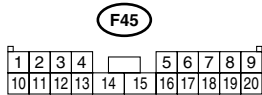
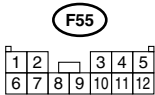
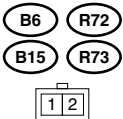
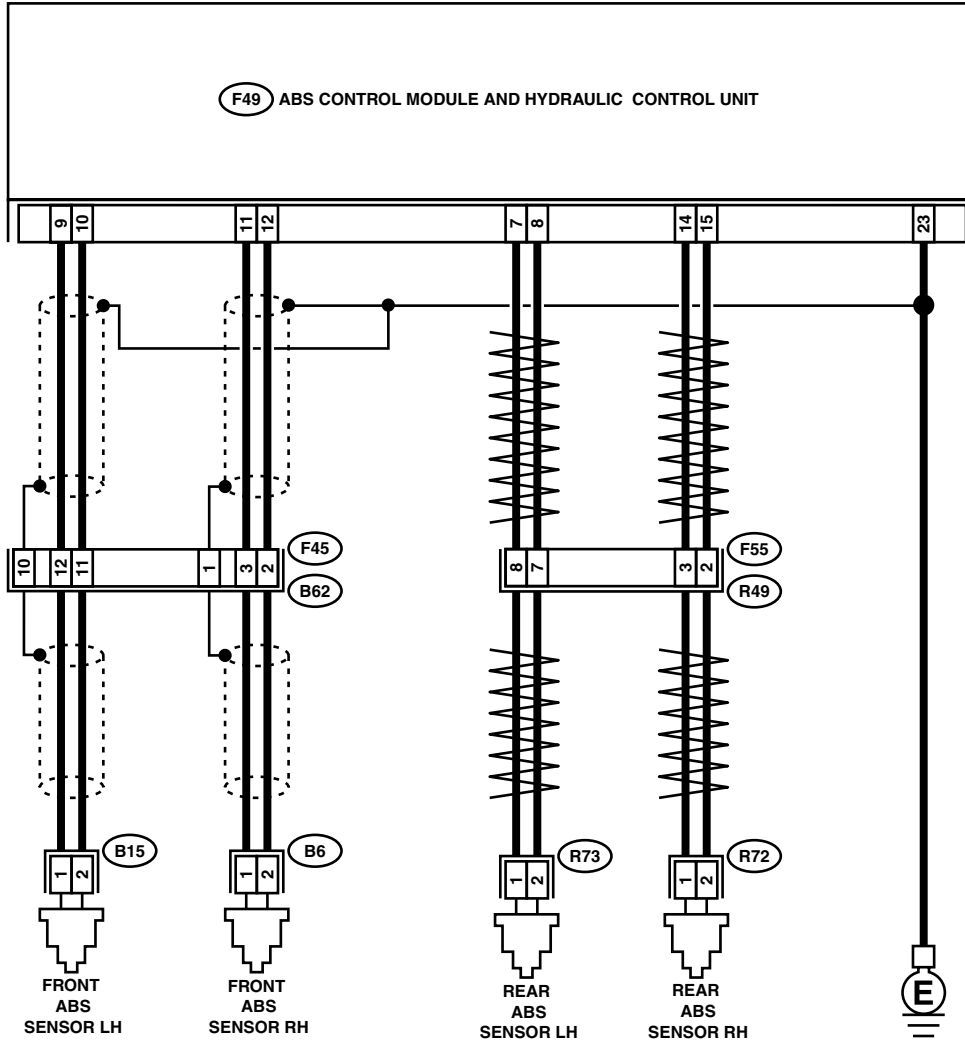

DIAGNOSTICS CHART WITH DIAGNOSIS CONNECTOR

ABS (DIAGNOSTICS)

Step	Check	Yes	No	
1	CHECK INSTALLATION OF ABS SENSOR. Turn ignition switch to OFF.	Are the ABS sensor installation bolts tightened to 33 N·m (3.4 kgf-m, 25 ft-lb)?	Go to step 2.	Tighten ABS sensor installation bolts securely.
2	CHECK ABS SENSOR GAP. Measure tone wheel to ABS sensor piece gap over entire perimeter of the wheel.	Is the measured value within the range indicated below? Front wheel 0.3 — 0.8 mm (0.012 — 0.031 in) and Rear wheel 0.44 — 0.94 mm (0.0173 — 0.0370 in)	Go to step 3.	Adjust the gap. NOTE: Adjust the gap using spacer (Part No. 26755AA000). If spacers cannot correct the gap, replace worn sensor or worn tone wheel.
3	PREPARE OSCILLOSCOPE.	Is an oscilloscope available?	Go to step 4.	Go to step 5.
4	CHECK ABS SENSOR SIGNAL. 1) Lift-up the vehicle. 2) Turn ignition switch OFF. 3) Connect the oscilloscope to the connector. 4) Turn ignition switch ON. 5) Rotate wheels and measure voltage at specified frequency. <Ref. to ABS-15, WAVEFORM, Control Module I/O Signal.> NOTE: When this inspection is completed, the ABS control module sometimes stores the trouble code 29. Connector & terminal DTC 22 / (B62) No. 3 (+) — No. 2 (-): DTC 24 / (B62) No. 12 (+) — No. 11 (-): DTC 26 / (F55) No. 3 (+) — No. 2 (-): DTC 28 / (F55) No. 8 (+) — No. 7 (-):	Is the oscilloscope pattern the same as that shown in the figure?	Go to step 8.	Go to step 7.
5	CHECK CONTAMINATION OF ABS SENSOR OR TONE WHEEL. Remove disc rotor or drum from hub in accordance with trouble code.	Is the ABS sensor piece or the tone wheel contaminated by mud or other foreign matter?	Thoroughly remove mud or other foreign matter.	Go to step 6.
6	CHECK DAMAGE OF ABS SENSOR OR TONE WHEEL.	Are there broken or damaged in the ABS sensor piece or the tone wheel?	Replace ABS sensor or tone wheel. Front: <Ref. to ABS-12, Front ABS Sensor.> Rear: <Ref. to ABS-15, Rear ABS Sensor.> and Front: <Ref. to ABS-19, Front Tone Wheel.> Rear: <Ref. to ABS-20, Rear Tone Wheel.>	Go to step 7.
7	CHECK TONE WHEEL RUNOUT. Measure tone wheel runout.	Is the measured value less than 0.05 mm (0.0020 in)?	Go to step 8.	Replace tone wheel. Front: <Ref. to ABS-19, Front Tone Wheel.> Rear: <Ref. to ABS-20, Rear Tone Wheel.>

DIAGNOSTICS CHART WITH DIAGNOSIS CONNECTOR

ABS (DIAGNOSTICS)

Step	Check	Yes	No
8 CHECK RESISTANCE OF ABS SENSOR. 1) Turn ignition switch OFF. 2) Disconnect connector from ABS sensor. 3) Measure resistance between ABS sensor connector terminals. Terminal <i>Front RH No. 1 — No. 2:</i> <i>Front LH No. 1 — No. 2:</i> <i>Rear RH No. 1 — No. 2:</i> <i>Rear LH No. 1 — No. 2:</i>	Is the measured value within 1 to 1.5 k Ω ?	Go to step 9.	Replace ABS sensor. Front: <Ref. to ABS-12, Front ABS Sensor.> Rear: <Ref. to ABS-15, Rear ABS Sensor.>
9 CHECK GROUND SHORT OF ABS SENSOR. Measure resistance between ABS sensor and chassis ground. Terminal <i>Front RH No. 1 — Chassis ground:</i> <i>Front LH No. 1 — Chassis ground:</i> <i>Rear RH No. 1 — Chassis ground:</i> <i>Rear LH No. 1 — Chassis ground:</i>	Is the measured value more than 1 M Ω ?	Go to step 10.	Replace ABS sensor. Front: <Ref. to ABS-12, Front ABS Sensor.> Rear: <Ref. to ABS-15, Rear ABS Sensor.>
10 CHECK HARNESS/CONNECTOR BETWEEN ABSCM&H/U AND ABS SENSOR. 1) Connect connector to ABS sensor. 2) Disconnect connector from ABSCM&H/U. 3) Measure resistance at ABSCM&H/U connector terminals. Connector & terminal <i>DTC 22 / (F49) No. 11 — No. 12:</i> <i>DTC 24 / (F49) No. 9 — No. 10:</i> <i>DTC 26 / (F49) No. 14 — No. 15:</i> <i>DTC 28 / (F49) No. 7 — No. 8:</i>	Is the measured value within 1 to 1.5 k Ω ?	Go to step 11.	Repair harness/connector between ABSCM&H/U and ABS sensor.
11 CHECK GROUND SHORT OF HARNESS. Measure resistance between ABSCM&H/U connector and chassis ground. Connector & terminal <i>DTC 22 / (F49) No. 11 — Chassis ground:</i> <i>DTC 24 / (F49) No. 9 — Chassis ground:</i> <i>DTC 26 / (F49) No. 14 — Chassis ground:</i> <i>DTC 28 / (F49) No. 7 — Chassis ground:</i>	Is the measured value more than 1 M Ω ?	Go to step 12.	Repair harness/connector between ABSCM&H/U and ABS sensor.
12 CHECK GROUND CIRCUIT OF ABSCM&H/U. Measure resistance between ABSCM&H/U and chassis ground. Connector & terminal <i>(F49) No. 23 — GND:</i>	Is the measured value less than 0.5 Ω ?	Go to step 13.	Repair ABSCM&H/U ground harness.
13 CHECK POOR CONTACT IN CONNECTORS.	Is there poor contact in connectors between ABSCM&H/U and ABS sensor?	Repair connector.	Go to step 14.
14 CHECK SOURCES OF SIGNAL NOISE.	Is the car telephone or the wireless transmitter properly installed?	Go to step 15.	Properly install the car telephone or the wireless transmitter.
15 CHECK SOURCES OF SIGNAL NOISE.	Are noise sources (such as an antenna) installed near the sensor harness?	Install the noise sources apart from the sensor harness.	Go to step 16.

DIAGNOSTICS CHART WITH DIAGNOSIS CONNECTOR

ABS (DIAGNOSTICS)

Step	Check	Yes	No
16 CHECK SHIELD CIRCUIT. 1) Connect all connectors. 2) Measure resistance between shield connector and chassis ground. Connector & terminal DTC 22 / (B62) No. 1 — Chassis ground: DTC 24 / (B62) No. 10 — Chassis ground: NOTE: For the DTC 26 and 28 : Go to step 17 .	Is the measured value less than 0.5 Ω?	Go to step 17 .	Repair shield harness.
17 CHECK ABSCM&H/U. 1) Connect all connectors. 2) Erase the memory. 3) Perform inspection mode. 4) Read out the DTC.	Is the same DTC still being output?	Replace ABSCM&H/U. <Ref. to ABS-6, ABS Control Module and Hydraulic Control Unit (ABSCM&H/U).>	Go to step 18 .
18 CHECK ANY OTHER DTC APPEARANCE.	Are other DTC being output?	Proceed with the diagnosis corresponding to the DTC.	A temporary noise interference.

DIAGNOSTICS CHART WITH DIAGNOSIS CONNECTOR

ABS (DIAGNOSTICS)

L: DTC 29 ABNORMAL ABS SENSOR SIGNAL (ANY ONE OF FOUR)

DIAGNOSIS:

- Faulty ABS sensor signal (noise, irregular signal, etc.)
- Faulty tone wheel
- Turning wheels freely for a long time

TROUBLE SYMPTOM:

- ABS does not operate.

WIRING DIAGRAM:

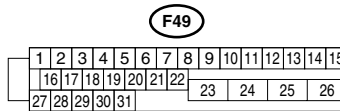
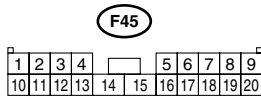
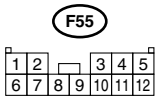
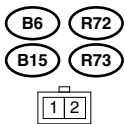
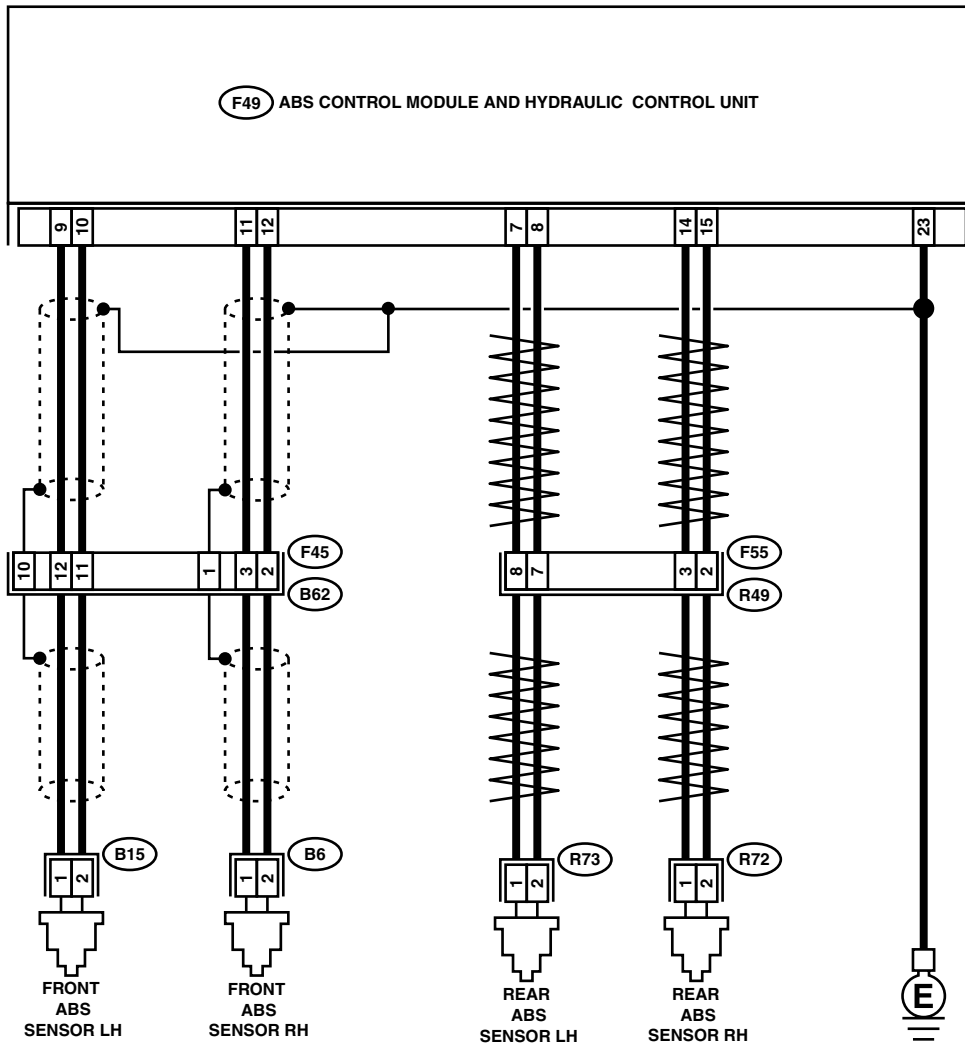

DIAGNOSTICS CHART WITH DIAGNOSIS CONNECTOR

ABS (DIAGNOSTICS)

Step	Check	Yes	No
1 CHECK IF THE WHEELS HAVE TURNED FREELY. Check if the wheels have been turned freely for more than one minute, such as when the vehicle is jacked-up, under full-lock cornering or when tire is not in contact with road surface.	Do wheels turn freely?	NOTE: When the wheels turn freely for a long time, such as when the vehicle is towed or jacked-up, or when steering wheel is continuously turned all the way, this trouble code may sometimes occur. The ABS is normal. Erase the DTC.	Go to step 2.
2 CHECK TIRE SPECIFICATIONS. Turn ignition switch to OFF.	Are the tire specifications correct?	Go to step 3.	Replace tire.
3 CHECK WEAR OF TIRE.	Is the tire worn excessively?	Replace tire.	Go to step 4.
4 CHECK TIRE PRESSURE.	Is the tire pressure correct?	Go to step 5.	Adjust tire pressure.
5 CHECK INSTALLATION OF ABS SENSOR. <i>Tightening torque:</i>	Are the ABS sensor installation bolts tightened to 33 N·m (3.4 kgf·m, 25 ft·lb)?	Go to step 6.	Tighten ABS sensor installation bolts.
6 CHECK ABS SENSOR GAP. Measure tone wheel to ABS sensor piece gap over entire perimeter of the wheel.	Is the measured value within the range indicated below? Front wheel 0.3 — 0.8 mm (0.012 — 0.031 in) and Rear wheel 0.44 — 0.94 mm (0.0173 — 0.0370 in)	Go to step 7.	Adjust the gap. NOTE: Adjust the gap using spacer (Part No. 26755AA000). If spacers cannot correct the gap, replace worn sensor or worn tone wheel.
7 PREPARE OSCILLOSCOPE.	Is an oscilloscope available?	Go to step 8.	Go to step 9.
8 CHECK ABS SENSOR SIGNAL. 1) Lift up the vehicle. 2) Turn ignition switch OFF. 3) Connect the oscilloscope to the connector. 4) Turn ignition switch ON. 5) Rotate wheels and measure voltage at specified frequency. <Ref. to ABS-15, WAVEFORM, Control Module I/O Signal.> NOTE: When this inspection is completed, the ABS/SCM&H/U sometimes stores the DTC 29. Connector & terminal (B62) No. 3 (+) — No. 2 (-) (Front RH): (B62) No. 12 (+) — No. 11 (-) (Front LH): (F55) No. 3 (+) — No. 2 (-) (Rear RH): (F55) No. 8 (+) — No. 7 (-) (Rear LH):	Is the oscilloscope pattern the same as that shown in the figure?	Go to step 12.	Go to step 9.
9 CHECK CONTAMINATION OF ABS SENSOR OR TONE WHEEL. Remove disc rotor from hub.	Is the ABS sensor piece or the tone wheel contaminated by dirt or other foreign matter?	Go to step 10.	Thoroughly remove dirt or other foreign matter.

DIAGNOSTICS CHART WITH DIAGNOSIS CONNECTOR

ABS (DIAGNOSTICS)

Step	Check	Yes	No	
10	CHECK DAMAGE OF ABS SENSOR OR TONE WHEEL.	Are there broken or damaged teeth in the ABS sensor piece or the tone wheel?	Replace ABS sensor or tone wheel. Front: <Ref. to ABS-12, Front ABS Sensor.> Rear: <Ref. to ABS-15, Rear ABS Sensor.> and Front: <Ref. to ABS-19, Front Tone Wheel.> Rear: <Ref. to ABS-20, Rear Tone Wheel.>	Go to step 11.
11	CHECK TONE WHEEL RUNOUT. Measure tone wheel runout.	Is the measured value less than 0.05 mm (0.0020 in)?	Go to step 12.	Replace tone wheel. Front: <Ref. to ABS-19, Front Tone Wheel.> Rear: <Ref. to ABS-20, Rear Tone Wheel.>
12	CHECK ABSCM&H/U. 1) Turn ignition switch to OFF. 2) Connect all connectors. 3) Erase the memory. 4) Perform inspection mode. 5) Read out the DTC.	Is the same DTC still being output?	Replace ABSCM&H/U. <Ref. to ABS-6, ABS Control Module and Hydraulic Control Unit (ABSCM&H/U).>	Go to step 13.
13	CHECK ANY OTHER DTC APPEARANCE.	Are other DTC being output?	Proceed with the diagnosis corresponding to the DTC.	A temporary poor contact.

DIAGNOSTICS CHART WITH DIAGNOSIS CONNECTOR

ABS (DIAGNOSTICS)

M: DTC 31 ABNORMAL INLET SOLENOID VALVE CIRCUIT(S) IN ABSCM&H/U (FRONT RH)

NOTE:

For the diagnostic procedure, refer to DTC 37. <Ref. to ABS-54, DTC 37 ABNORMAL INLET SOLENOID VALVE CIRCUIT(S) IN ABSCM&H/U (REAR LH), Diagnostics Chart with Diagnosis Connector.>

N: DTC 33 ABNORMAL INLET SOLENOID VALVE CIRCUIT(S) IN ABSCM&H/U (FRONT LH)

NOTE:

For the diagnostic procedure, refer to DTC 37. <Ref. to ABS-54, DTC 37 ABNORMAL INLET SOLENOID VALVE CIRCUIT(S) IN ABSCM&H/U (REAR LH), Diagnostics Chart with Diagnosis Connector.>

O: DTC 35 ABNORMAL INLET SOLENOID VALVE CIRCUIT(S) IN ABSCM&H/U (REAR RH)

NOTE:

For the diagnostic procedure, refer to DTC 37. <Ref. to ABS-54, DTC 37 ABNORMAL INLET SOLENOID VALVE CIRCUIT(S) IN ABSCM&H/U (REAR LH), Diagnostics Chart with Diagnosis Connector.>

DIAGNOSTICS CHART WITH DIAGNOSIS CONNECTOR

ABS (DIAGNOSTICS)

P: DTC 37 ABNORMAL INLET SOLENOID VALVE CIRCUIT(S) IN ABSCM&H/U (REAR LH)

DIAGNOSIS:

- Faulty harness/connector
- Faulty inlet solenoid valve in ABSCM&H/U

TROUBLE SYMPTOM:

- ABS does not operate.

WIRING DIAGRAM:

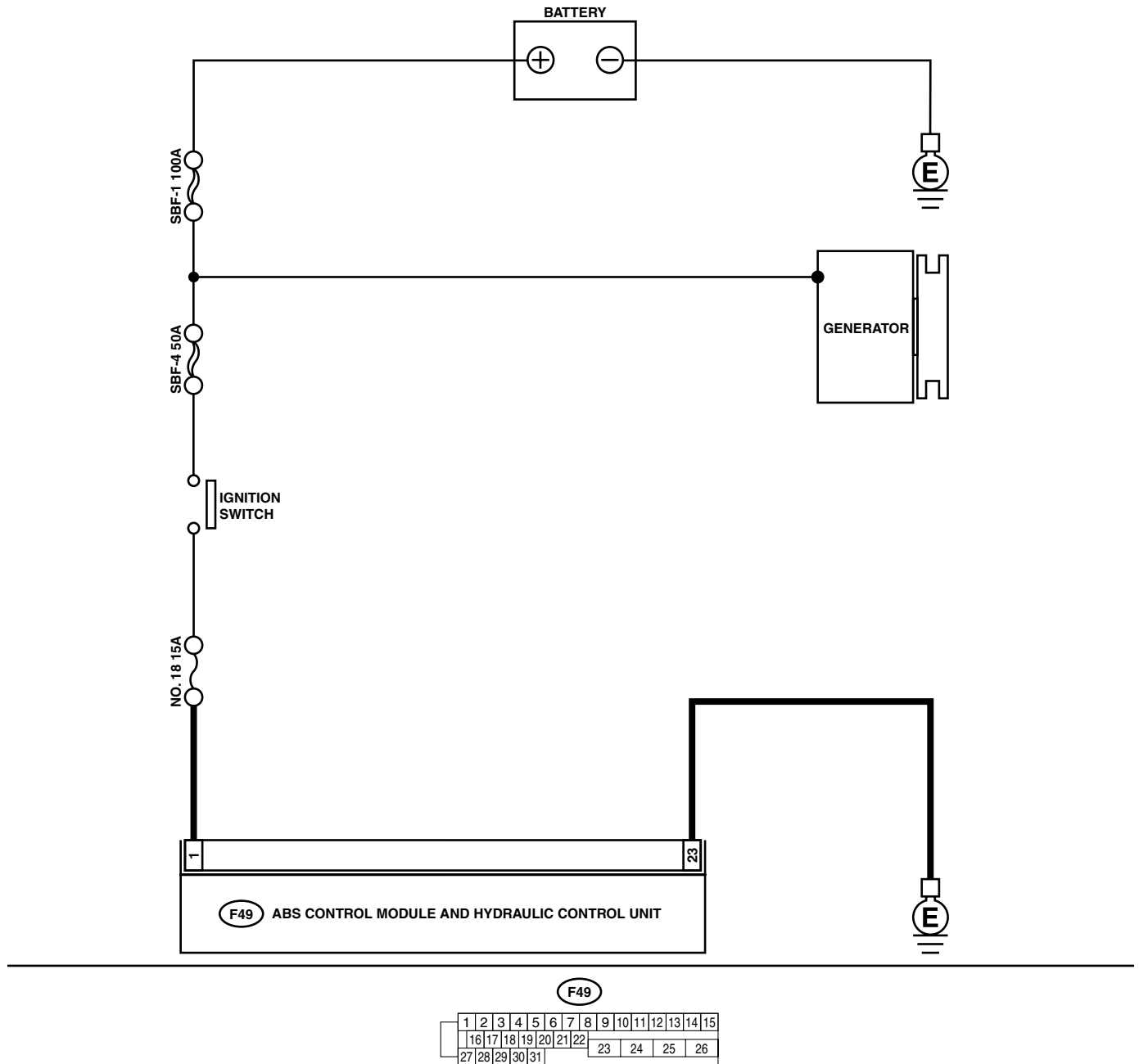

DIAGNOSTICS CHART WITH DIAGNOSIS CONNECTOR

ABS (DIAGNOSTICS)

Step	Check	Yes	No
1 CHECK INPUT VOLTAGE OF ABSCM&H/U. 1) Disconnect connector from ABSCM&H/U. 2) Run the engine at idle. 3) Measure voltage between ABSCM&H/U connector and chassis ground. Connector & terminal (F49) No. 1 (+) — Chassis ground (-):	Is the measured value within 10 to 15 V?	Go to step 2.	Repair harness connector between battery, ignition switch and ABSCM&H/U.
2 CHECK GROUND CIRCUIT OF ABSCM&H/U. 1) Turn ignition switch to OFF. 2) Measure resistance between ABSCM&H/U connector and chassis ground. Connector & terminal (F49) No. 23 — Chassis ground:	Is the measured value less than 0.5 Ω?	Go to step 3.	Repair ABSCM&H/U ground harness.
3 CHECK POOR CONTACT IN CONNECTORS.	Is there poor contact in connectors between generator, battery and ABSCM&H/U?	Repair connector.	Go to step 4.
4 CHECK ABSCM&H/U. 1) Connect all connectors. 2) Erase the memory. 3) Perform inspection mode. 4) Read out the DTC.	Is the same DTC still being output?	Replace ABSCM&H/U. <Ref. to ABS-6, ABS Control Module and Hydraulic Control Unit (ABSCM&H/U).>	Go to step 5.
5 CHECK ANY OTHER DTC APPEARANCE.	Are other DTC being output?	Proceed with the diagnosis corresponding to the DTC.	A temporary poor contact.

DIAGNOSTICS CHART WITH DIAGNOSIS CONNECTOR

ABS (DIAGNOSTICS)

Q: DTC 32 ABNORMAL OUTLET SOLENOID VALVE CIRCUIT(S) IN ABSCM&H/ U (FRONT RH)

NOTE:

For the diagnostic procedure, refer to DTC 38. <Ref. to ABS-58, DTC 38 ABNORMAL OUTLET SOLENOID VALVE CIRCUIT(S) IN ABSCM&H/U (REAR LH), Diagnostics Chart with Diagnosis Connector.>

R: DTC 34 ABNORMAL OUTLET SOLENOID VALVE CIRCUIT(S) IN ABSCM&H/ U (FRONT LH)

NOTE:

For the diagnostic procedure, refer to DTC 38. <Ref. to ABS-58, DTC 38 ABNORMAL OUTLET SOLENOID VALVE CIRCUIT(S) IN ABSCM&H/U (REAR LH), Diagnostics Chart with Diagnosis Connector.>

S: DTC 36 ABNORMAL OUTLET SOLENOID VALVE CIRCUIT(S) IN ABSCM&H/ U (REAR RH)

NOTE:

For the diagnostic procedure, refer to DTC 38. <Ref. to ABS-58, DTC 38 ABNORMAL OUTLET SOLENOID VALVE CIRCUIT(S) IN ABSCM&H/U (REAR LH), Diagnostics Chart with Diagnosis Connector.>

DIAGNOSTICS CHART WITH DIAGNOSIS CONNECTOR

ABS (DIAGNOSTICS)

MEMO:

DIAGNOSTICS CHART WITH DIAGNOSIS CONNECTOR

ABS (DIAGNOSTICS)

T: DTC 38 ABNORMAL OUTLET SOLENOID VALVE CIRCUIT(S) IN ABSCM&H/ U (REAR LH)

DIAGNOSIS:

- Faulty harness/connector
- Faulty outlet solenoid valve in ABSCM&H/U

TROUBLE SYMPTOM:

- ABS does not operate.

WIRING DIAGRAM:

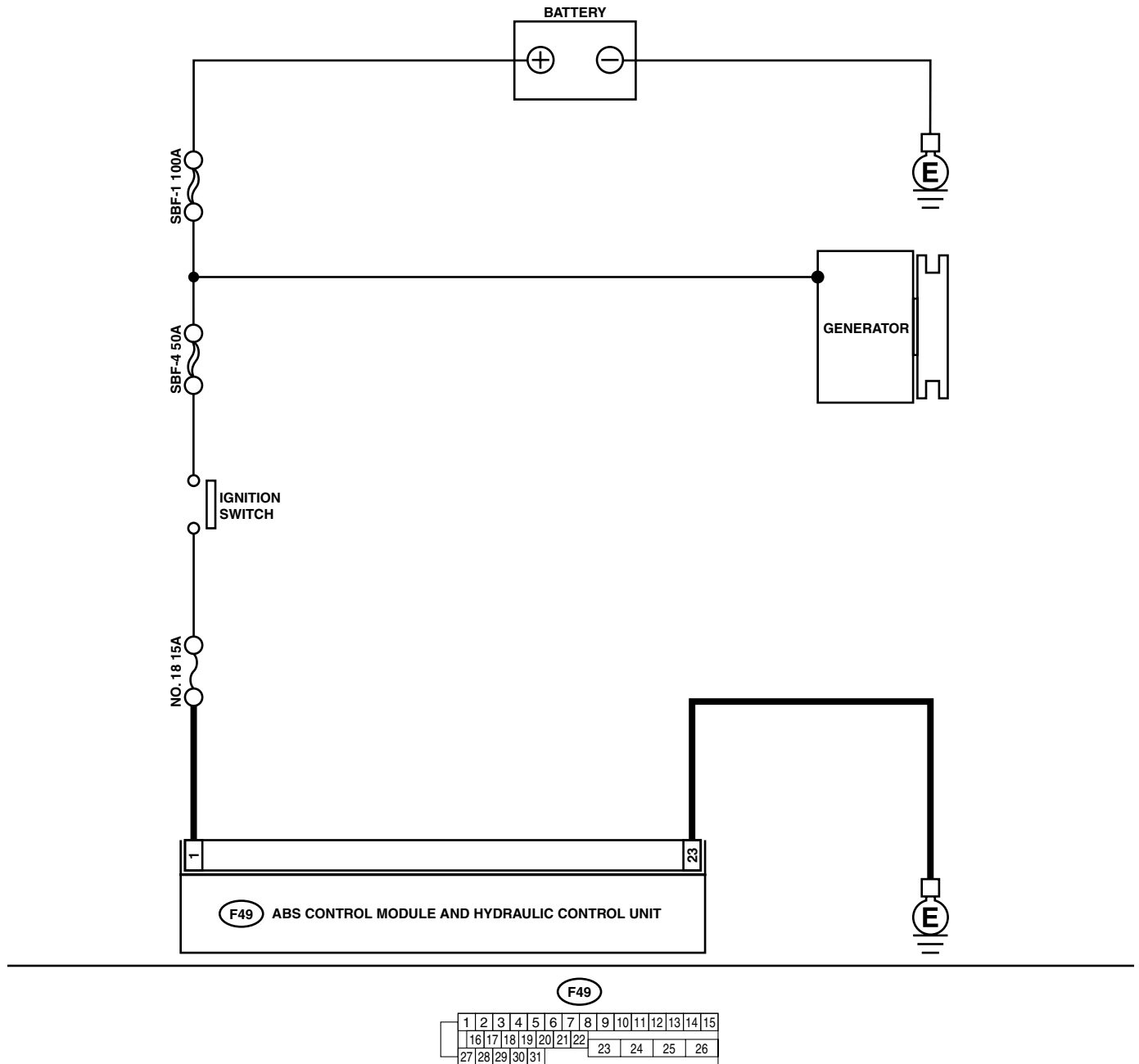

DIAGNOSTICS CHART WITH DIAGNOSIS CONNECTOR

ABS (DIAGNOSTICS)

Step	Check	Yes	No
1 CHECK INPUT VOLTAGE OF ABSCM&H/U. 1) Disconnect connector from ABSCM&H/U. 2) Run the engine at idle. 3) Measure voltage between ABSCM&H/U connector and chassis ground. Connector & terminal (F49) No. 1 (+) — Chassis ground (-):	Is the measured value within 10 to 15 V?	Go to step 2.	Repair harness connector between battery, ignition switch and ABSCM&H/U.
2 CHECK GROUND CIRCUIT OF ABSCM&H/U. 1) Turn ignition switch to OFF. 2) Measure resistance between ABSCM&H/U connector and chassis ground. Connector & terminal (F49) No. 23 — Chassis ground:	Is the measured value less than 0.5 Ω?	Go to step 3.	Repair ABSCM&H/U ground harness.
3 CHECK POOR CONTACT IN CONNECTORS.	Is there poor contact in connectors between generator, battery and ABSCM&H/U?	Repair connector.	Go to step 4.
4 CHECK ABSCM&H/U. 1) Connect all connectors. 2) Erase the memory. 3) Perform inspection mode. 4) Read out the DTC.	Is the same DTC still being output?	Replace ABSCM&H/U. <Ref. to ABS-6, ABS Control Module and Hydraulic Control Unit (ABSCM&H/U).>	Go to step 5.
5 CHECK ANY OTHER DTC APPEARANCE.	Are other DTC being output?	Proceed with the diagnosis corresponding to the DTC.	A temporary poor contact.

DIAGNOSTICS CHART WITH DIAGNOSIS CONNECTOR

ABS (DIAGNOSTICS)

U: DTC 41 ABNORMAL ABS CONTROL MODULE

DIAGNOSIS:

- Faulty ABSCM&H/U.

TROUBLE SYMPTOM:

- ABS does not operate.

WIRING DIAGRAM:

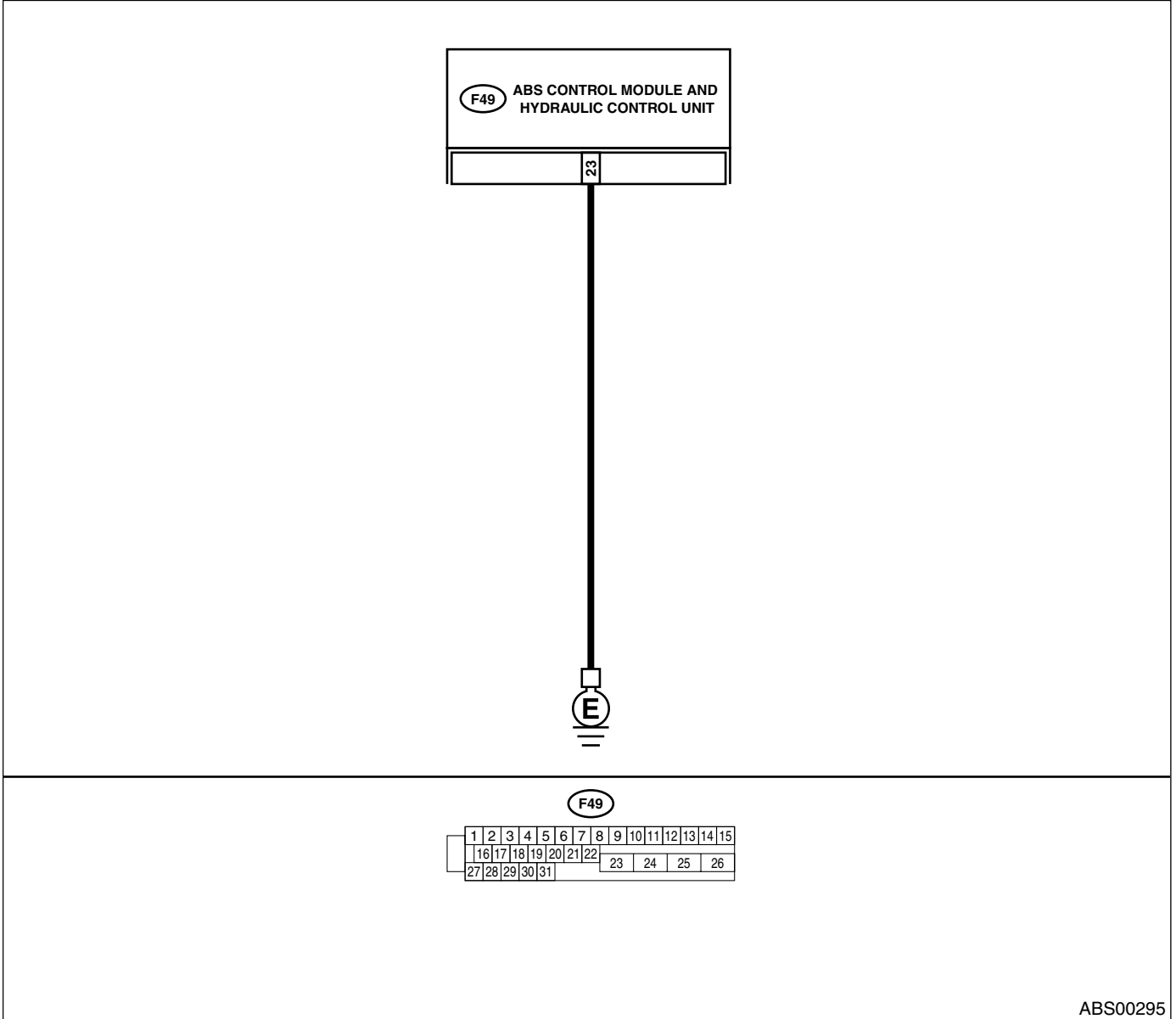

Step	Check	Yes	No	
1	CHECK GROUND CIRCUIT OF ABSCM&H/U. 1) Turn ignition switch to OFF. 2) Disconnect connector from ABSCM&H/U. 3) Measure resistance between ABSCM&H/U and chassis ground. Connector & terminal (F49) No. 23 — Chassis ground:	Is the measured value less than 0.5 Ω?	Go to step 2.	Repair ABSCM&H/U ground harness.
2	CHECK POOR CONTACT IN CONNECTORS.	Is there poor contact in connectors between battery, ignition switch and ABSCM&H/U?	Repair connector.	Go to step 3.

DIAGNOSTICS CHART WITH DIAGNOSIS CONNECTOR

ABS (DIAGNOSTICS)

Step	Check	Yes	No	
3	CHECK SOURCES OF SIGNAL NOISE.	Is the car telephone or the wireless transmitter properly installed?	Properly install the car telephone or the wireless transmitter.	Go to step 4.
4	CHECK SOURCES OF SIGNAL NOISE.	Are noise sources (such as an antenna) installed near the sensor harness?	Install the noise sources apart from the sensor harness.	Go to step 5.
5	CHECK ABSCM&H/U. 1) Connect all connectors. 2) Erase the memory. 3) Perform inspection mode. 4) Read out the DTC.	Is the same DTC as in the current diagnosis still being output?	Replace ABSCM&H/U. <Ref. to ABS-6, ABS Control Module and Hydraulic Control Unit (ABSCM&H/U).>	Go to step 6.
6	CHECK ANY OTHER DTC APPEARANCE.	Are other DTC being output?	Proceed with the diagnosis corresponding to the DTC.	A temporary poor contact.

DIAGNOSTICS CHART WITH DIAGNOSIS CONNECTOR

ABS (DIAGNOSTICS)

V: DTC 42 SOURCE VOLTAGE IS ABNORMAL.

DIAGNOSIS:

- Power source voltage of the ABSCM&H/U is low or high.

TROUBLE SYMPTOM:

- ABS does not operate.

WIRING DIAGRAM:

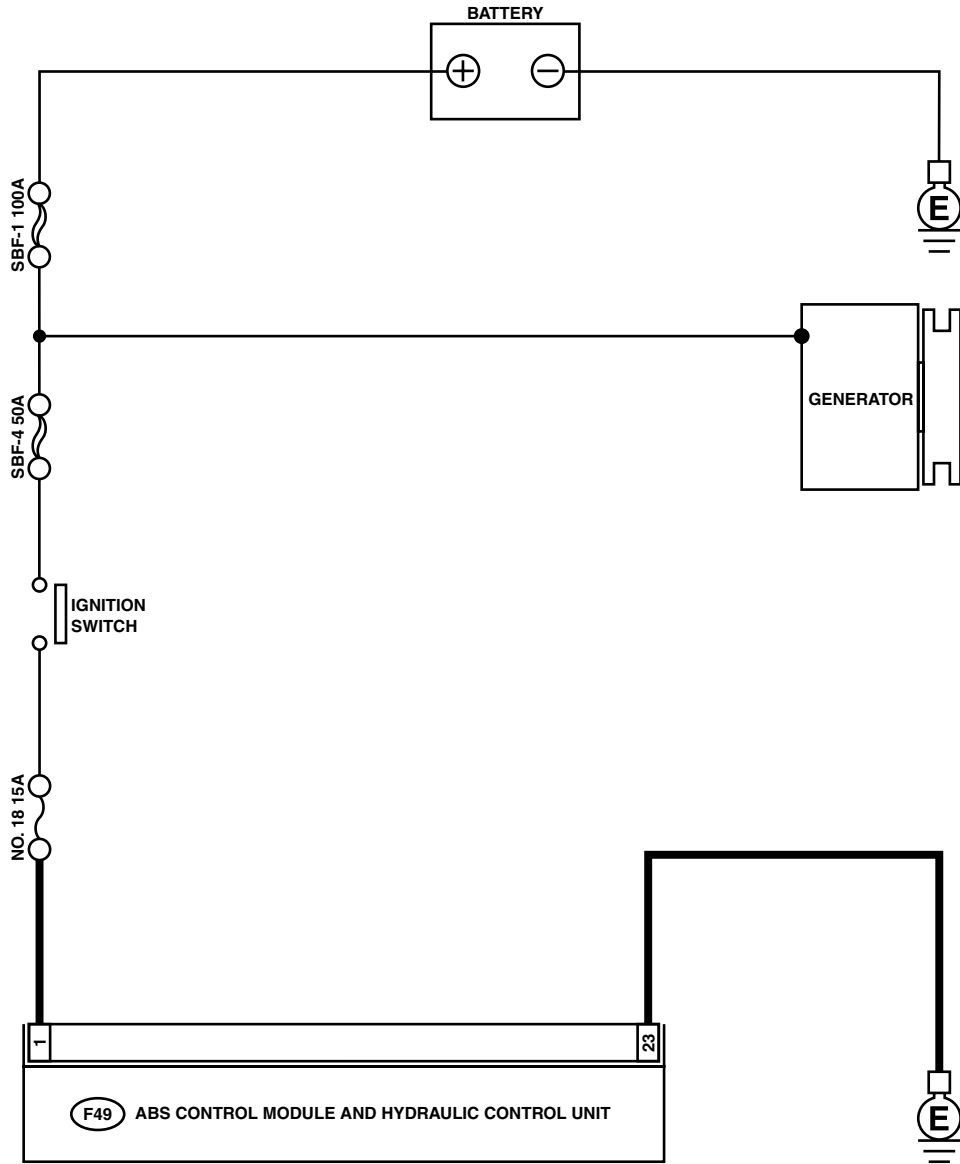

F49

1	2	3	4	5	6	7	8	9	10	11	12	13	14	15
16	17	18	19	20	21	22	23	24	25	26				
27	28	29	30	31										

ABS00294

DIAGNOSTICS CHART WITH DIAGNOSIS CONNECTOR

ABS (DIAGNOSTICS)

Step	Check	Yes	No
1 CHECK GENERATOR. 1) Start engine. 2) Idling after warm-up. 3) Measure voltage between generator B terminal and chassis ground. <i>Terminal</i> <i>Generator B terminal — Chassis ground:</i>	Is the measured value within 10 to 17 V?	Go to step 2.	Repair generator. H4 engine model: <Ref. to SC-<Ref. to SC(H4SO)-15, Generator.>, Generator.> H6 engine model: <Ref. to SC(H6)-<Ref. to SC(H6DO)-14, Generator.>, Generator.>
2 CHECK BATTERY TERMINAL. Turn ignition switch to OFF.	Are the positive and negative battery terminals tightly clamped?	Go to step 3.	Tighten the clamp of terminal.
3 CHECK INPUT VOLTAGE OF ABSCM&H/U. 1) Disconnect connector from ABSCM&H/U. 2) Run the engine at idle. 3) Measure voltage between ABSCM&H/U connector and chassis ground. <i>Connector & terminal</i> <i>(F49) No. 1 (+) — Chassis ground (-):</i>	Is the measured value within 10 to 17 V?	Go to step 4.	Repair harness connector between battery, ignition switch and ABSCM&H/U.
4 CHECK GROUND CIRCUIT OF ABSCM&H/U. 1) Turn ignition switch to OFF. 2) Measure resistance between ABSCM&H/U connector and chassis ground. <i>Connector & terminal</i> <i>(F49) No. 23 — Chassis ground:</i>	Is the measured value less than 0.5 Ω?	Go to step 5.	Repair ABSCM&H/U ground harness.
5 CHECK POOR CONTACT IN CONNECTORS.	Is there poor contact in connectors between generator, battery and ABSCM&H/U?	Repair connector.	Go to step 6.
6 CHECK ABSCM&H/U. 1) Connect all connectors. 2) Erase the memory. 3) Perform inspection mode. 4) Read out the DTC.	Is the same DTC still being output?	Replace ABSCM&H/U. <Ref. to ABS-6, ABS Control Module and Hydraulic Control Unit (ABSCM&H/U).>	Go to step 7.
7 CHECK ANY OTHER DTC APPEARANCE.	Are other DTC being output?	Proceed with the diagnosis corresponding to the DTC.	A temporary poor contact.

DIAGNOSTICS CHART WITH DIAGNOSIS CONNECTOR

ABS (DIAGNOSTICS)

W: DTC 44 A COMBINATION OF AT CONTROL ABNORMAL

DIAGNOSIS:

- Combination of AT control faults

TROUBLE SYMPTOM:

- ABS does not operate.

WIRING DIAGRAM:

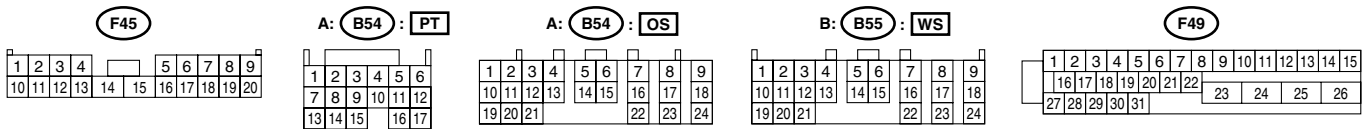
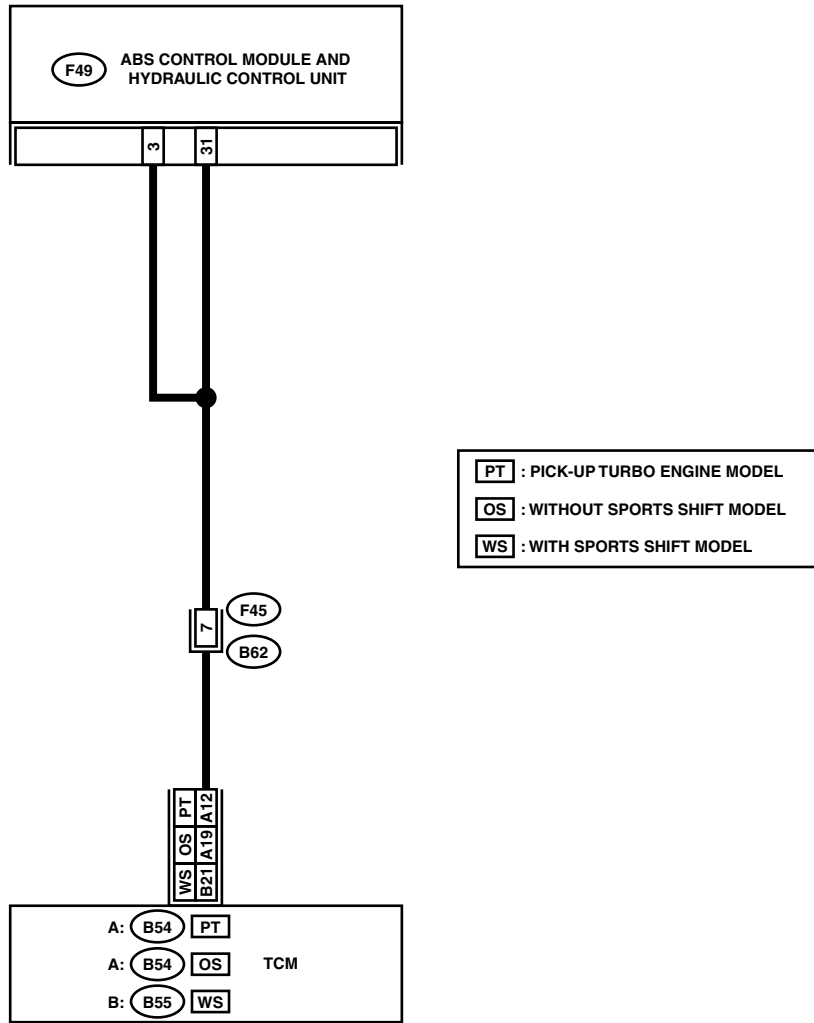

ABS00426

DIAGNOSTICS CHART WITH DIAGNOSIS CONNECTOR

ABS (DIAGNOSTICS)

Step	Check	Yes	No
1 CHECK SPECIFICATIONS OF THE AB-SCM&H/U. Check specifications of the mark to the ABSCM&H/U. CG: AT (Except OUTBACK,BAJA) CH: MT (Except OUTBACK,BAJA) CI: AT (OUTBACK,BAJA) CJ: MT (OUTBACK,BAJA)	Do the vehicle specification and the specification of ABSCM&HU match?	Go to step 2.	Replace ABSCM&H/U. <Ref. to ABS-6, ABS Control Module and Hydraulic Control Unit (ABSCM&H/U).>
2 CHECK GROUND SHORT OF HARNESS. 1) Turn ignition switch to OFF. 2) Disconnect two connectors from TCM. 3) Disconnect connector from ABSCM&H/U. 4) Measure resistance between ABSCM&H/U connector and chassis ground. Connector & terminal (F49) No. 3 — Chassis ground:	Is the measured value less than 1 MΩ?	Go to step 3.	Repair harness between TCM and ABSCM&H/U.
3 CHECK BATTERY SHORT OF HARNESS. Measure voltage between ABSCM&H/U connector and chassis ground. Connector & terminal (F49) No. 3 (+) — Chassis ground (-):	Is the measured value less than 1 V?	Go to step 4.	Repair harness between TCM and ABSCM&H/U.
4 CHECK BATTERY SHORT OF HARNESS. 1) Turn ignition switch to ON. 2) Measure voltage between ABSCM&H/U connector and chassis ground. Connector & terminal (F49) No. 3 (+) — Chassis ground (-):	Is the measured value less than 1 V?	Go to step 5.	Repair harness between TCM and ABSCM&H/U.
5 CHECK TCM. 1) Turn ignition switch to OFF. 2) Connect all connectors to TCM. 3) Turn ignition switch to ON. 4) Measure voltage between TCM connector terminal and chassis ground. Connector & terminal PT: (B54) No. 12 (+) — Chassis ground (-): DS: (B54) No. 19 (+) — Chassis ground (-): WS: (B55) No. 21 (+) — Chassis ground (-):	Is the measured value within 10 to 15 V?	Go to step 7.	Go to step 6.
6 CHECK AT.	Is the AT functioning normally?	Replace TCM.	Repair AT.
7 CHECK OPEN CIRCUIT OF HARNESS. Measure voltage between ABSCM&H/U connector and chassis ground. Connector & terminal (F49) No. 3 (+) — Chassis ground (-): (F49) No. 31 (+) — Chassis ground (-):	Is the measured value within 10 to 15 V?	Go to step 8.	Repair harness/connector between TCM and ABSCM&H/U.
8 CHECK POOR CONTACT IN CONNECTORS.	Is there poor contact in connectors between TCM and ABSCM&H/U?	Repair connector.	Go to step 9.
9 CHECK ABSCM&H/U. 1) Turn ignition switch to OFF. 2) Connect all connectors. 3) Erase the memory. 4) Perform inspection mode. 5) Read out the DTC.	Is the same DTC still being output?	Replace ABSCM&H/U. <Ref. to ABS-6, ABS Control Module and Hydraulic Control Unit (ABSCM&H/U).>	Go to step 10.

DIAGNOSTICS CHART WITH DIAGNOSIS CONNECTOR

ABS (DIAGNOSTICS)

Step	Check	Yes	No
10 CHECK ANY OTHER DTC APPEARANCE.	Are other DTC being output?	Proceed with the diagnosis corresponding to the DTC.	A temporary poor contact.

DIAGNOSTICS CHART WITH DIAGNOSIS CONNECTOR

ABS (DIAGNOSTICS)

MEMO:

DIAGNOSTICS CHART WITH DIAGNOSIS CONNECTOR

ABS (DIAGNOSTICS)

X: DTC 51 ABNORMAL VALVE RELAY

DIAGNOSIS:

- Faulty valve relay

TROUBLE SYMPTOM:

- ABS does not operate.

WIRING DIAGRAM:

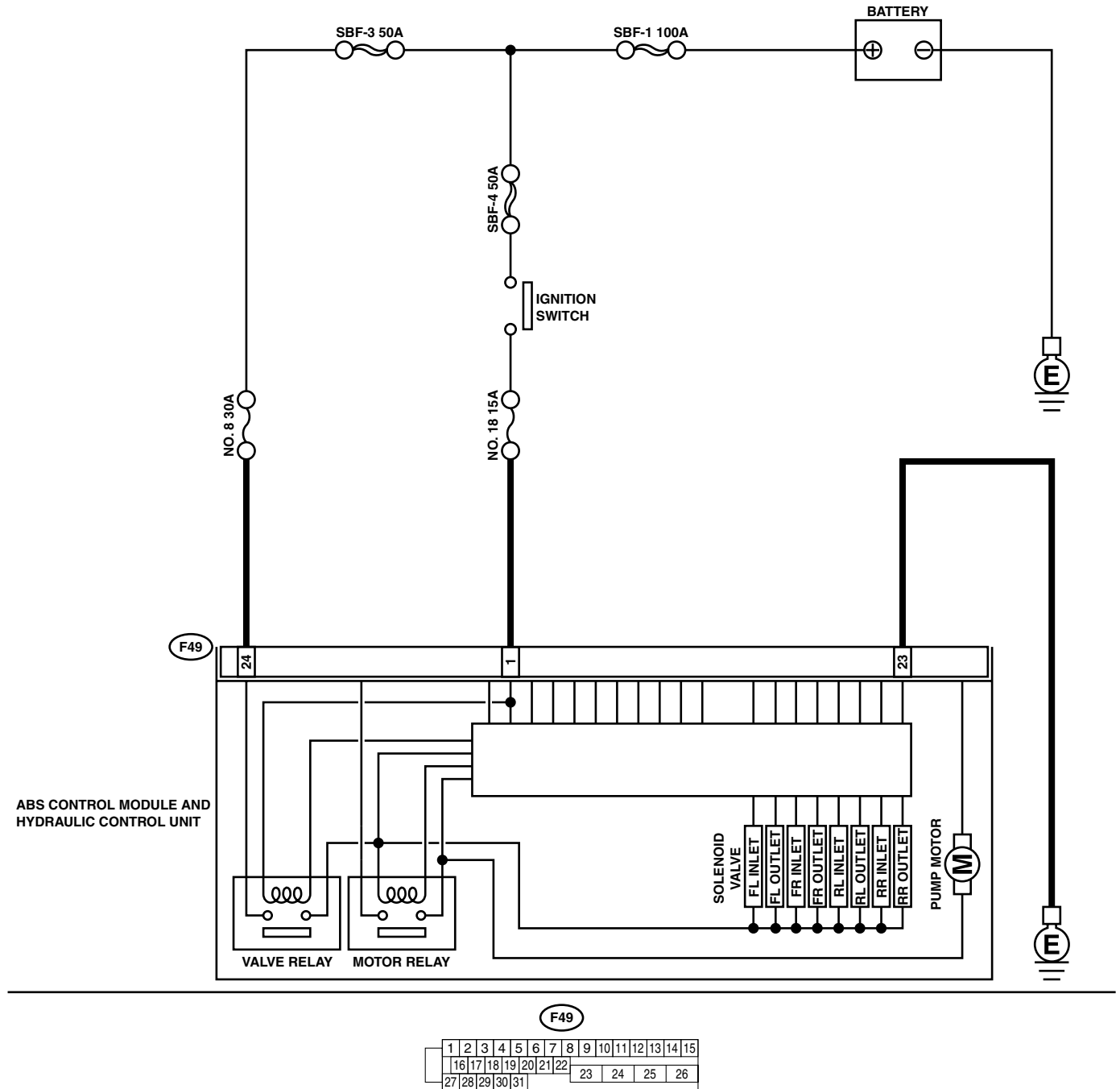

F49

1	2	3	4	5	6	7	8	9	10	11	12	13	14	15
16	17	18	19	20	21	22	23	24	25	26				
27	28	29	30	31										

ABS00297

DIAGNOSTICS CHART WITH DIAGNOSIS CONNECTOR

ABS (DIAGNOSTICS)

Step	Check	Yes	No
1 CHECK INPUT VOLTAGE OF ABSCM&H/U. 1) Turn ignition switch to OFF. 2) Disconnect connector from ABSCM&H/U. 3) Run the engine at idle. 4) Measure voltage between ABSCM&H/U connector and chassis ground. Connector & terminal (F49) No. 1 (+) — Chassis ground (-): (F49) No. 24 (+) — Chassis ground (-):	Is the measured value within 10 to 15 V?	Go to step 2.	Repair harness connector between battery and ABSCM&H/U.
2 CHECK GROUND CIRCUIT OF ABSCM&H/U. 1) Turn ignition switch to OFF. 2) Measure resistance between ABSCM&H/U connector and chassis ground. Connector & terminal (F49) No. 23 — Chassis ground:	Is the measured value less than 0.5 Ω?	Go to step 3.	Repair ABSCM&H/U ground harness.
3 CHECK VALVE RELAY IN ABSCM&H/U. Measure resistance between ABSCM&H/U and terminals. Terminals No. 23 (+) — No. 24 (-):	Is the measured value more than 1 MΩ?	Go to step 4.	Replace ABSCM&H/U. <Ref. to ABS-6, ABS Control Module and Hydraulic Control Unit (ABSCM&H/U).>
4 CHECK POOR CONTACT IN CONNECTORS.	Is there poor contact in connectors between generator, battery and ABSCM&H/U?	Repair connector.	Go to step 5.
5 CHECK ABSCM&H/U. 1) Connect all connectors. 2) Erase the memory. 3) Perform inspection mode. 4) Read out the DTC.	Is the same DTC still being output?	Replace ABSCM&H/U. <Ref. to ABS-6, ABS Control Module and Hydraulic Control Unit (ABSCM&H/U).>	Go to step 6.
6 CHECK ANY OTHER DTC APPEARANCE.	Are other DTC being output?	Proceed with the diagnosis corresponding to the DTC.	A temporary poor contact.

DIAGNOSTICS CHART WITH DIAGNOSIS CONNECTOR

ABS (DIAGNOSTICS)

Y: DTC 52 ABNORMAL MOTOR AND/OR MOTOR RELAY

DIAGNOSIS:

- Faulty motor
- Faulty motor relay
- Faulty harness connector

TROUBLE SYMPTOM:

- ABS does not operate.

WIRING DIAGRAM:

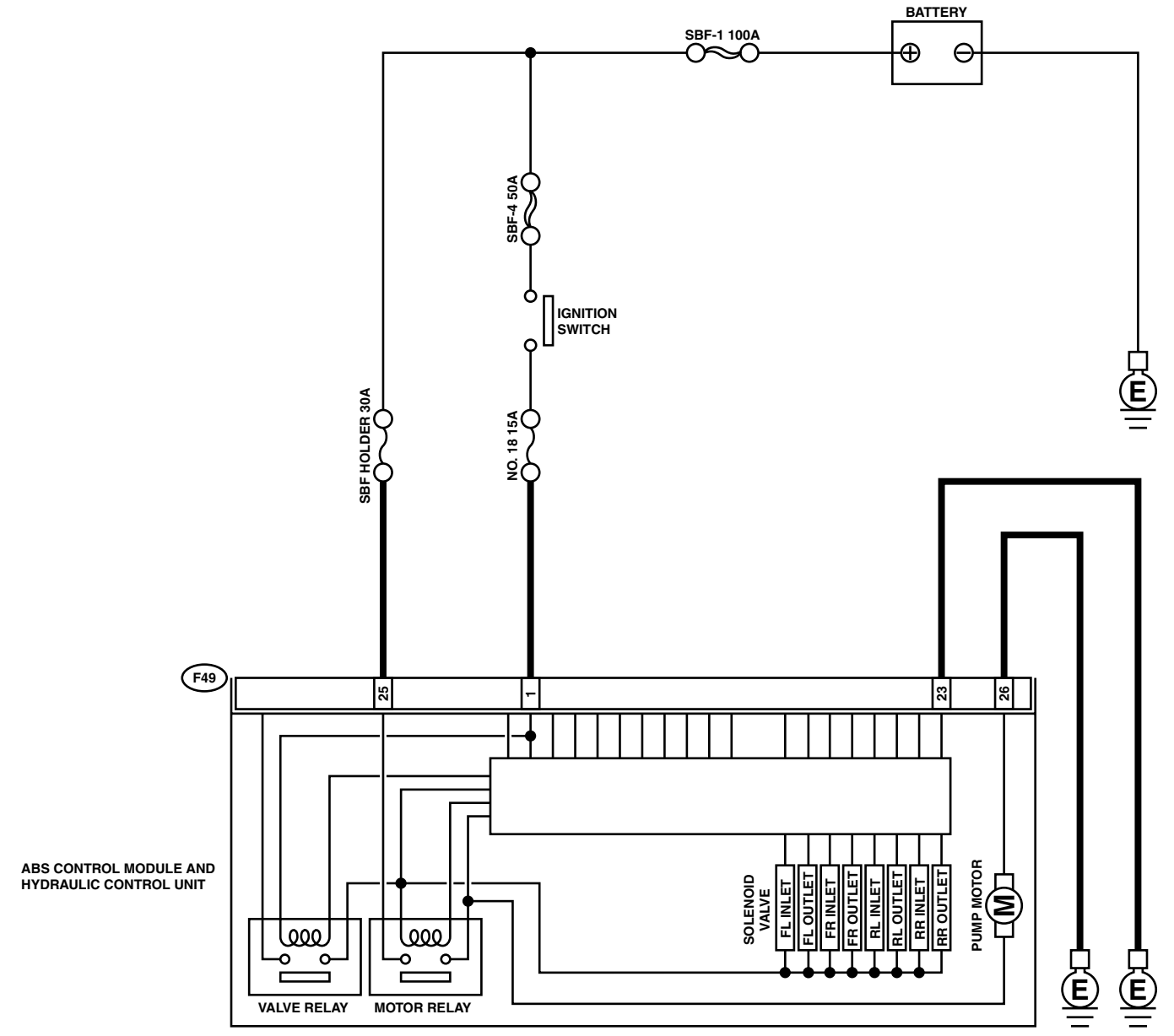

F49

1	2	3	4	5	6	7	8	9	10	11	12	13	14	15
16	17	18	19	20	21	22	23	24	25	26				
27	28	29	30	31										

ABS00427

DIAGNOSTICS CHART WITH DIAGNOSIS CONNECTOR

ABS (DIAGNOSTICS)

Step	Check	Yes	No
1 CHECK INPUT VOLTAGE OF ABSCM&H/U. 1) Turn ignition switch to OFF. 2) Disconnect connector from ABSCM&H/U. 3) Turn ignition switch to ON. 4) Measure voltage between ABSCM&H/U connector and chassis ground. Connector & terminal (F49) No. 25 (+) — Chassis ground (-):	Is the measured value within 10 to 15 V?	Go to step 2.	Repair harness/connector between battery and ABSCM&H/U and check fuse SBF-holder.
2 CHECK GROUND CIRCUIT OF MOTOR. 1) Turn ignition switch to OFF. 2) Measure resistance between ABSCM&H/U connector and chassis ground. Connector & terminal (F49) No. 26 — Chassis ground:	Is the measured value less than 0.5 Ω?	Go to step 3.	Repair ABSCM&H/U ground harness.
3 CHECK INPUT VOLTAGE OF ABSCM&H/U. 1) Run the engine at idle. 2) Measure voltage between ABSCM&H/U connector and chassis ground. Connector & terminal (F49) No. 1 (+) — Chassis ground (-):	Is the measured value within 10 to 15 V?	Go to step 4.	Repair harness connector between battery, ignition switch and ABSCM&H/U.
4 CHECK GROUND CIRCUIT OF ABSCM&H/U. 1) Turn ignition switch to OFF. 2) Measure resistance between ABSCM&H/U connector and chassis ground. Connector & terminal (F49) No. 23 — Chassis ground:	Is the measured value less than 0.5 Ω?	Go to step 5.	Repair ABSCM&H/U ground harness.
5 CHECK MOTOR OPERATION. Operate the sequence control. <Ref. to ABS-9, ABS Sequence Control.> NOTE: Use the diagnosis connector to operate the sequence control.	Can motor revolution noise (buzz) be heard when carrying out the sequence control?	Go to step 6.	Replace ABSCM&H/U. <Ref. to ABS-6, ABS Control Module and Hydraulic Control Unit (ABSCM&H/U).>
6 CHECK POOR CONTACT IN CONNECTORS. Turn ignition switch to OFF.	Is there poor contact in connector between generator, battery and ABSCM&H/U?	Repair connector.	Go to step 7.
7 CHECK ABSCM&H/U. 1) Connect all connectors. 2) Erase the memory. 3) Perform inspection mode. 4) Read out the DTC.	Is the same DTC still being output?	Replace ABSCM&H/U. <Ref. to ABS-6, ABS Control Module and Hydraulic Control Unit (ABSCM&H/U).>	Go to step 8.
8 CHECK ANY OTHER DTC APPEARANCE.	Are other DTC being output?	Proceed with the diagnosis corresponding to the DTC.	A temporary poor contact.

DIAGNOSTICS CHART WITH DIAGNOSIS CONNECTOR

ABS (DIAGNOSTICS)

Z: DTC 54 ABNORMAL STOP LIGHT SWITCH

DIAGNOSIS:

- Faulty stop light switch

TROUBLE SYMPTOM:

- ABS does not operate.

WIRING DIAGRAM:

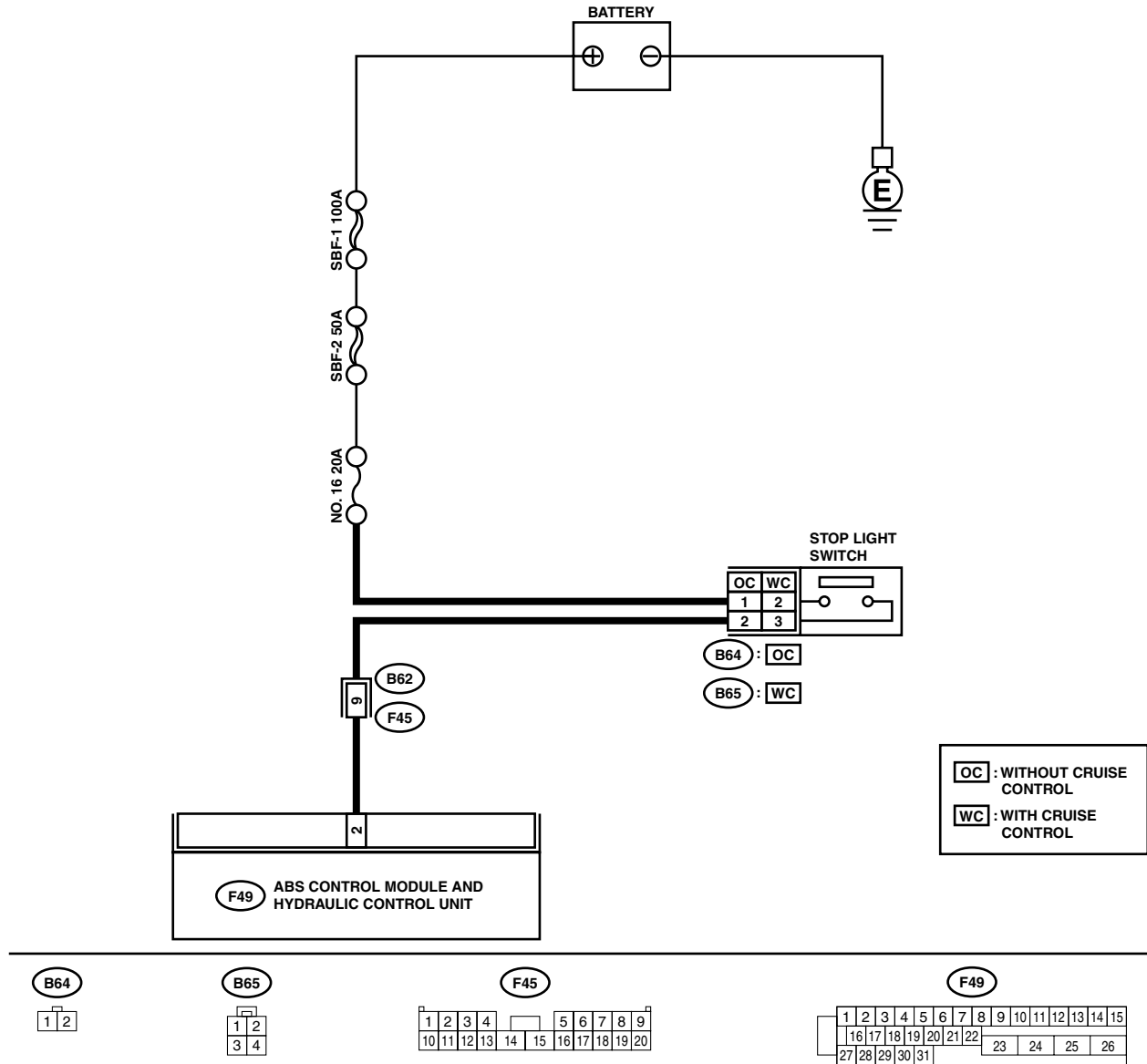

ABS00428

DIAGNOSTICS CHART WITH DIAGNOSIS CONNECTOR

ABS (DIAGNOSTICS)

Step	Check	Yes	No
1 CHECK STOP LIGHTS COME ON. Depress the brake pedal.	Do stop lights come on?	Go to step 2.	Repair stop lights circuit.
2 CHECK OPEN CIRCUIT IN HARNESS. 1) Turn ignition switch to OFF. 2) Disconnect connector from ABSCM&H/U. 3) Depress brake pedal. 4) Measure voltage between ABSCM&H/U connector and chassis ground. <i>Connector & terminal</i> <i>(F49) No. 2 (+) — Chassis ground (-):</i>	Is the measured value within 10 to 15 V?	Go to step 3.	Repair harness between stop light switch and ABSCM&H/U.
3 CHECK POOR CONTACT IN CONNECTORS.	Is there poor contact in connector between stop light switch and ABSCM&H/U?	Repair connector.	Go to step 4.
4 CHECK ABSCM&H/U. 1) Connect all connectors. 2) Erase the memory. 3) Perform inspection mode. 4) Read out the DTC.	Is the same DTC still being output?	Replace ABSCM&H/U. <Ref. to ABS-6, ABS Control Module and Hydraulic Control Unit (ABSCM&H/U).>	Go to step 5.
5 CHECK ANY OTHER DTC APPEARANCE.	Are other DTC being output?	Proceed with the diagnosis corresponding to the DTC.	A temporary poor contact.

DIAGNOSTICS CHART WITH DIAGNOSIS CONNECTOR

ABS (DIAGNOSTICS)

AA:DTC 56 ABNORMAL G SENSOR OUTPUT VOLTAGE

DIAGNOSIS:

- Faulty G sensor output voltage

TROUBLE SYMPTOM:

- ABS does not operate.

WIRING DIAGRAM:

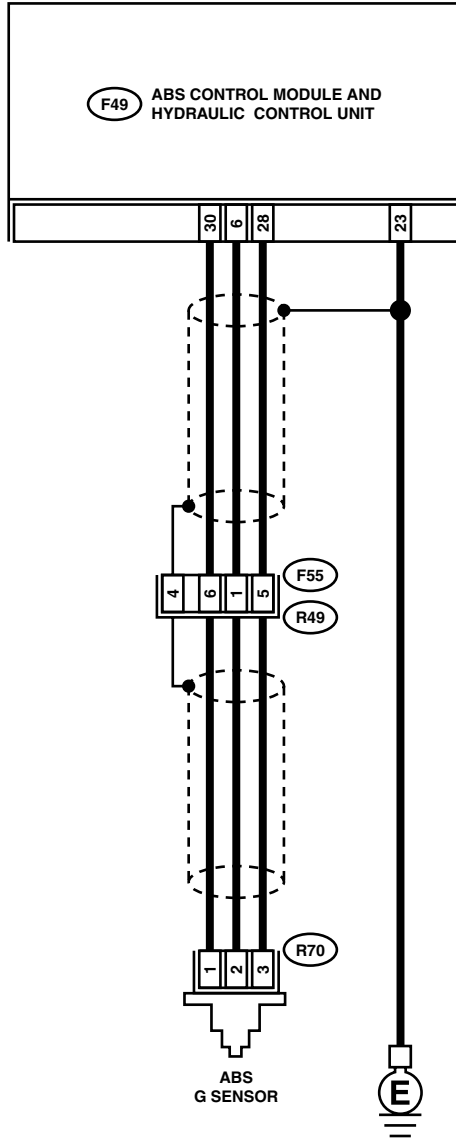

R70

1	2	3
---	---	---

F55

1	2	3	4	5		
6	7	8	9	10	11	12

F49

1	2	3	4	5	6	7	8	9	10	11	12	13	14	15
16	17	18	19	20	21	22	23	24	25	26				
27	28	29	30	31										

ABS00429

DIAGNOSTICS CHART WITH DIAGNOSIS CONNECTOR

ABS (DIAGNOSTICS)

Step	Check	Yes	No
1 CHECK WHEELS FOR FREE TURNING. Check if the wheels have been turned freely such as when the vehicle is lifted up, or operated on a rolling road.	Have wheels turned freely?	The ABS is normal. Erase the DTC.	Go to step 2.
2 CHECK SPECIFICATIONS OF ABSCM&H/U. Check specifications of the mark to the ABSCM&H/U. CG: AT (Except OUTBACK) CH: MT (Except OUTBACK) CI: AT (OUTBACK) CJ: MT (OUTBACK)	Does the vehicle specification and the ABSCM&H/U specification match?	Go to step 3.	Replace ABSCM&H/U. <Ref. to ABS-6, ABS Control Module and Hydraulic Control Unit (ABSCM&H/U).> CAUTION: Be sure to turn ignition switch to OFF when removing ABSCM&H/U.
3 CHECK INPUT VOLTAGE OF G SENSOR. 1) Turn ignition switch to OFF. 2) Remove console box. 3) Disconnect G sensor from body. (Do not disconnect connector.) 4) Turn ignition switch to ON. 5) Measure voltage between G sensor connector terminals. Connector & terminal (R70) No. 1 (+) — No. 3 (-):	Is the measured value within 4.75 to 5.25 V?	Go to step 4.	Repair harness/connector between G sensor and ABSCM&H/U.
4 CHECK OPEN CIRCUIT IN G SENSOR OUTPUT HARNESS AND GROUND HARNESS. 1) Turn ignition switch to OFF. 2) Disconnect connector from ABSCM&H/U. 3) Measure resistance between ABSCM&H/U connector terminals. Connector & terminal (F49) No. 6 — No. 28:	Is the measured value within 5.0 to 5.6 k Ω ?	Go to step 5.	Repair harness/connector between G sensor and ABSCM&H/U.
5 CHECK GROUND SHORT IN G SENSOR OUTPUT HARNESS. 1) Disconnect connector from G sensor. 2) Measure resistance between ABSCM&H/U connector and chassis ground. Connector & terminal (F49) No. 6 — Chassis ground:	Is the measured value more than 1 M Ω ?	Go to step 6.	Repair harness between G sensor and ABSCM&H/U.
6 CHECK BATTERY SHORT OF HARNESS. Measure voltage between ABSCM&H/U connector and chassis ground. Connector & terminal (F49) No. 6 (+) — Chassis ground (-):	Is the measured value less than 1 V?	Go to step 7.	Repair harness between G sensor and ABSCM&H/U.
7 CHECK BATTERY SHORT OF HARNESS. 1) Turn ignition switch to ON. 2) Measure voltage between ABSCM&H/U connector and chassis ground. Connector & terminal (F49) No. 6 (+) — Chassis ground (-):	Is the measured value less than 1 V?	Go to step 8.	Repair harness between G sensor and ABSCM&H/U.

DIAGNOSTICS CHART WITH DIAGNOSIS CONNECTOR

ABS (DIAGNOSTICS)

Step	Check	Yes	No
8 CHECK GROUND SHORT OF HARNESS. Measure resistance between ABSCM&H/U connector and chassis ground. <i>Connector & terminal</i> <i>(F49) No. 28 — Chassis ground:</i>	Is the measured value more than 1 MΩ?	Go to step 9.	Repair harness between G sensor and ABSCM&H/U. Replace ABSCM&H/U. <Ref. to ABS-6, ABS Control Module and Hydraulic Control Unit (ABSCM&H/U).>
9 CHECK G SENSOR. 1) Turn ignition switch to OFF. 2) Remove G sensor from vehicle. 3) Connect connector to G sensor. 4) Connect connector to ABSCM&H/U. 5) Turn ignition switch to ON. 6) Measure voltage between G sensor connector terminals. <i>Connector & terminal</i> <i>(R70) No. 2 (+) — No. 3 (-):</i>	Is the measured value within 2.1 to 2.5 V when G sensor is horizontal?	Go to step 10.	Replace G sensor. <Ref. to ABS-21, G Sensor.>
10 CHECK G SENSOR. Measure voltage between G sensor connector terminals. <i>Connector & terminal</i> <i>(R70) No. 2 (+) — No. 3 (-):</i>	Is the measured value within 3.7 to 4.1 V when G sensor is inclined forward to 90°?	Go to step 11.	Replace G sensor. <Ref. to ABS-21, G Sensor.>
11 CHECK G SENSOR. Measure voltage between G sensor connector terminals. <i>Connector & terminal</i> <i>(R70) No. 2 (+) — No. 3 (-):</i>	Is the measured value within 0.5 to 0.9 V when G sensor is inclined backward to 90°?	Go to step 12.	Replace G sensor. <Ref. to ABS-21, G Sensor.>
12 CHECK POOR CONTACT IN CONNECTORS.	Is there poor contact in connector between ABSCM&H/U and G sensor?	Repair connector.	Go to step 13.
13 CHECK ABSCM&H/U. 1) Connect all connectors. 2) Erase the memory. 3) Perform inspection mode. 4) Read out the DTC.	Is the same DTC still being output?	Replace ABSCM&H/U. <Ref. to ABS-6, ABS Control Module and Hydraulic Control Unit (ABSCM&H/U).>	Go to step 14.
14 CHECK ANY OTHER DTC APPEARANCE.	Are other DTC being output?	Proceed with the diagnosis corresponding to the DTC.	A temporary poor contact.

DIAGNOSTICS CHART WITH DIAGNOSIS CONNECTOR

ABS (DIAGNOSTICS)

MEMO:

DIAGNOSTICS CHART WITH SUBARU SELECT MONITOR

ABS (DIAGNOSTICS)

13. Diagnostics Chart with Subaru Select Monitor

A: COMMUNICATION FOR INITIALIZING IMPOSSIBLE

DIAGNOSIS:

- Faulty harness connector

TROUBLE SYMPTOM:

- ABS warning light remains on.

WIRING DIAGRAM:

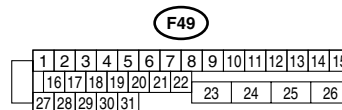
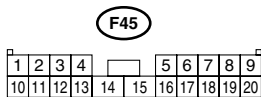
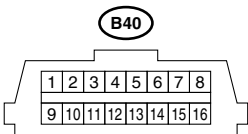
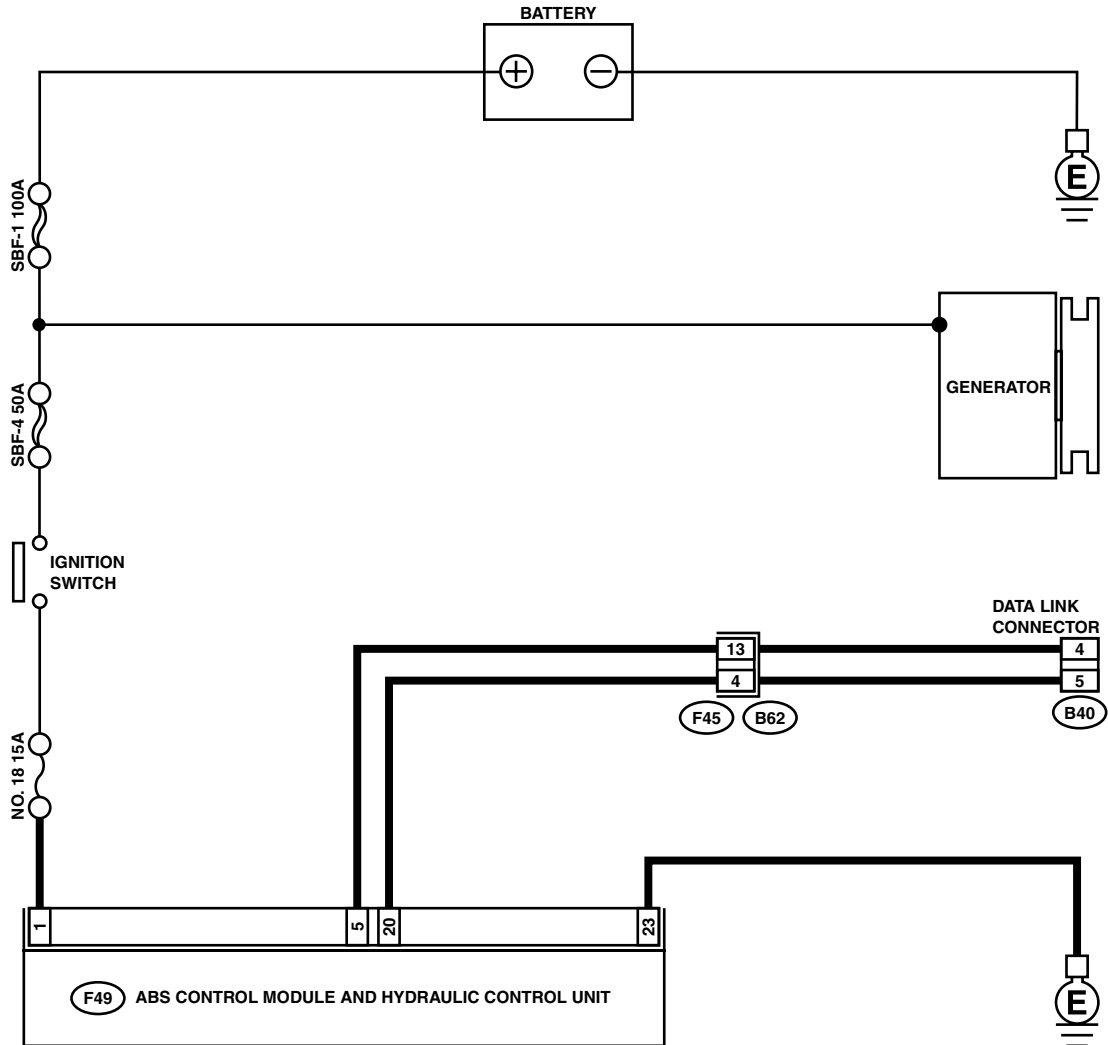

DIAGNOSTICS CHART WITH SUBARU SELECT MONITOR

ABS (DIAGNOSTICS)

Step	Check	Yes	No	
1	CHECK IGNITION SWITCH.	Is ignition switch to ON?	Go to step 2.	Turn ignition switch to ON, and select ABS mode using the select monitor.
2	CHECK BATTERY. 1) Turn ignition switch to OFF. 2) Measure battery voltage.	Is the measured value more than 11 V?	Go to step 3.	Charge or replace battery.
3	CHECK BATTERY TERMINAL.	Is there poor contact at battery terminal?	Repair or tighten battery terminal.	Go to step 4.
4	CHECK COMMUNICATION OF SELECT MONITOR. 1) Turn ignition switch to ON. 2) Using the select monitor, check whether communication to other systems can be executed normally.	Are the name and year of the system displayed on the select monitor?	Go to step 7.	Go to step 5.
5	CHECK COMMUNICATION OF SELECT MONITOR. 1) Turn ignition switch to OFF. 2) Disconnect ABSCM&H/U connector. 3) Check whether communication to other systems can be executed normally.	Are the name and year of the system displayed on the select monitor?	Go to step 7.	Go to step 6.
6	CHECK HARNESS CONNECTOR BETWEEN EACH CONTROL MODULE AND DATA LINK CONNECTOR. 1) Turn ignition switch to OFF. 2) Disconnect ABSCM&H/U, cruise control module and immobilizer control module connectors. 3) Measure resistance between data link connector and chassis ground. Connector & terminal (B40) No. 5 — Chassis ground: (B40) No. 4 — Chassis ground:	Is the measured value more than 1 MΩ?	Go to step 7.	Repair harness and connector between each control module and data link connector.
7	CHECK OUTPUT SIGNAL FOR ABSCM&H/U. 1) Turn ignition switch to ON. 2) Measure voltage between data link connector and chassis ground. Connector & terminal (B40) No. 5 (+) — Chassis ground (-): (B40) No. 4 (+) — Chassis ground (-):	Is the measured value more than 1 V?	Repair harness and connector between each control module and data link connector.	Go to step 8.
8	CHECK HARNESS/CONNECTOR BETWEEN ABSCM&H/U AND DATA LINK CONNECTOR. Measure resistance between ABSCM&H/U connector and data link connector. Connector & terminal (F49) No. 20 — (B40) No. 5: (F49) No. 5 — (B40) No. 4:	Is the measured value less than 0.5 Ω?	Repair harness and connector between ABSCM&H/U and data link connector.	Go to step 9.
9	CHECK INSTALLATION OF ABSCM&H/U CONNECTOR. Turn ignition switch to OFF.	Is ABSCM&H/U connector inserted into ABSCM&H/U until the clamp locks onto it?	Go to step 10.	Insert ABSCM&H/U connector into ABSCM&H/U.

DIAGNOSTICS CHART WITH SUBARU SELECT MONITOR

ABS (DIAGNOSTICS)

Step	Check	Yes	No
10 CHECK POWER SUPPLY CIRCUIT. 1) Turn ignition switch to ON (engine OFF). 2) Measure ignition power supply voltage between ABSCM&H/U connector and chassis ground. Connector & terminal (F49) No. 1 (+) — Chassis ground (-):	Is the measured value more than 10 V?	Go to step 11.	Repair open circuit in harness between ABSCM&H/U and battery.
11 CHECK HARNESS CONNECTOR BETWEEN ABSCM&H/U AND CHASSIS GROUND. 1) Turn ignition switch to OFF. 2) Disconnect connector from ABSCM&H/U and transmission. 3) Measure resistance of harness between ABSCM&H/U and chassis ground. Connector & terminal (F49) No. 23 — Chassis ground:	Is the measured value less than 1 Ω?	Go to step 12.	Repair open circuit in harness between ABSCM&H/U and inhibitor side connector, and poor contact in coupling connector.
12 CHECK POOR CONTACT IN CONNECTORS.	Is there poor contact in control module power supply, ground line and data link connector?	Repair connector.	Replace ABSCM&H/U. <Ref. to ABS-6, ABS Control Module and Hydraulic Control Unit (ABSCM&H/U).>

B: NO TROUBLE CODE

DIAGNOSIS:

- ABS warning light circuit is shorted.

TROUBLE SYMPTOM:

- ABS warning light remains on.
- NO TROUBLE CODE displayed on the select monitor.

NOTE:

When the ABS warning light is OFF and "NO TROUBLE CODE" is displayed on the select monitor, the system is in normal condition.

DIAGNOSTICS CHART WITH SUBARU SELECT MONITOR

ABS (DIAGNOSTICS)

WIRING DIAGRAM:

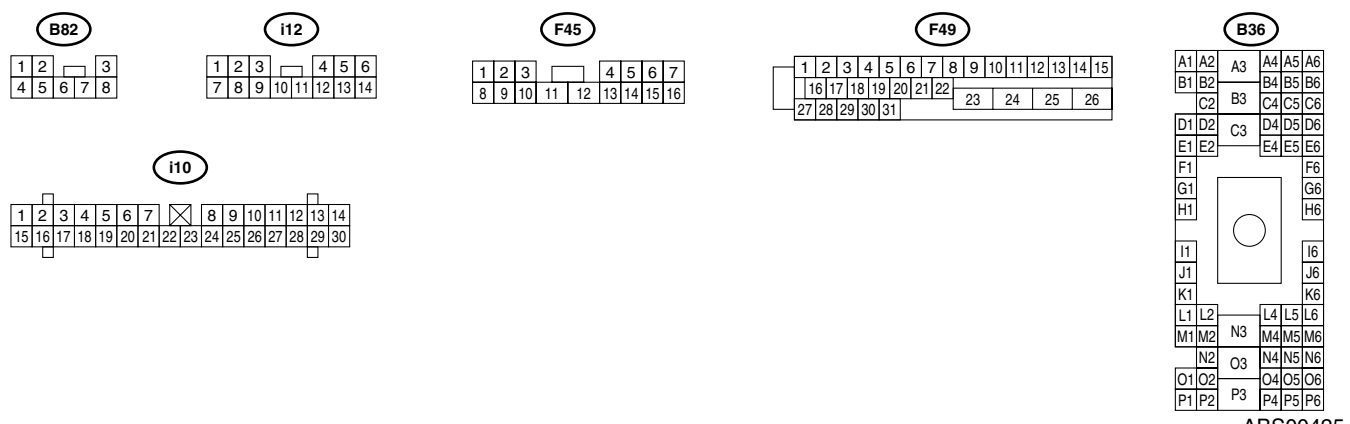
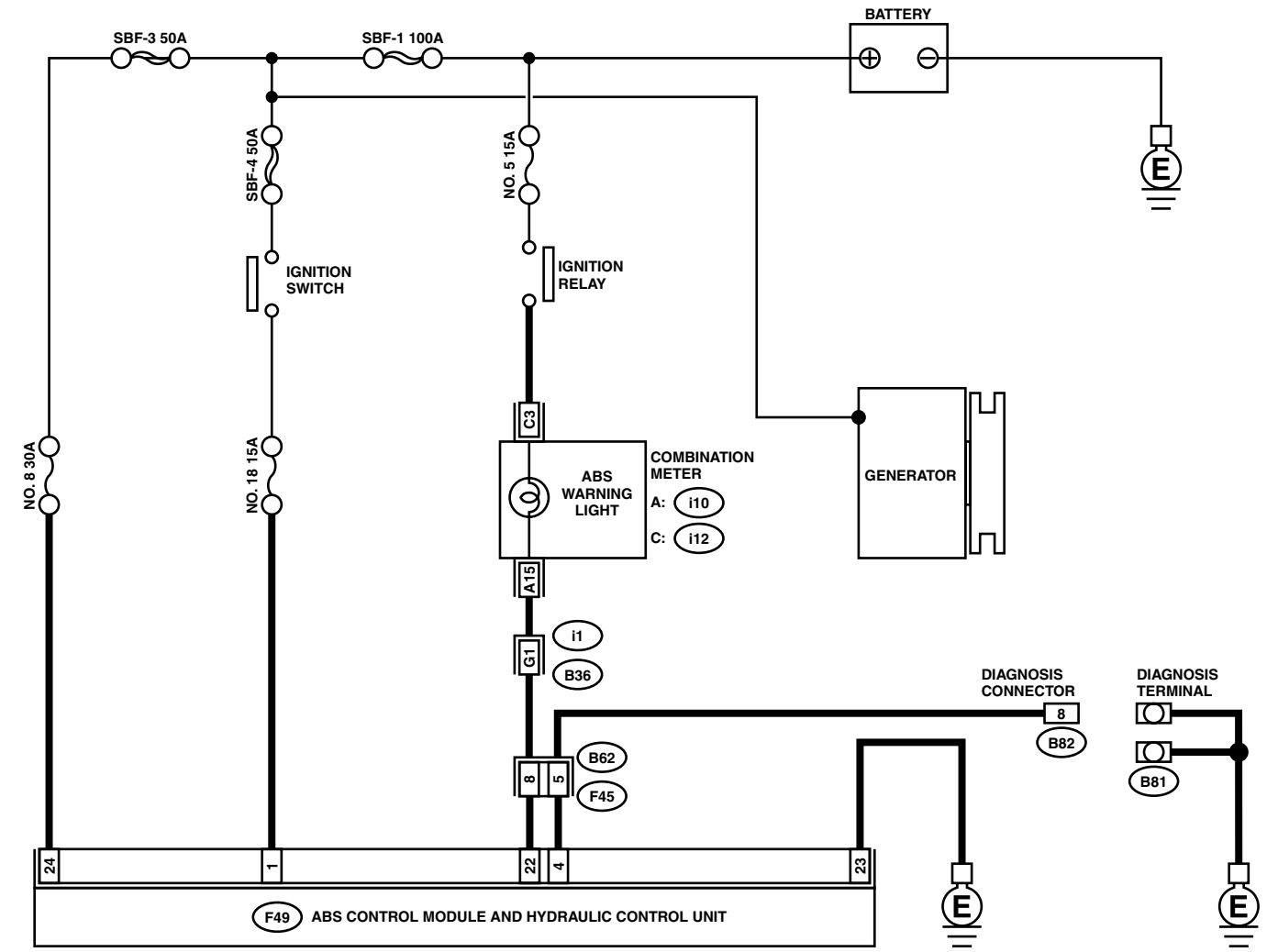

ABS00425

Step	Check	Yes	No
1 CHECK WIRING HARNESS. 1) Turn ignition switch to OFF. 2) Disconnect connector (F45) from connector (B62). 3) Turn ignition switch to ON.	Does the ABS warning light turn on?	Go to step 2.	Repair front wiring harness.

DIAGNOSTICS CHART WITH SUBARU SELECT MONITOR

ABS (DIAGNOSTICS)

Step	Check	Yes	No
2 CHECK PROJECTION AT ABSCM&H/U. 1) Turn ignition switch to OFF. 2) Disconnect connector from ABSCM&H/U. 3) Check for broken projection at the ABSCM&H/U terminal.	Is there any damage on ABSCM&HU terminal?	Replace ABSCM&H/U. <Ref. to ABS-6, ABS Control Module and Hydraulic Control Unit (ABSCM&H/U).>	Go to step 3.
3 CHECK ABSCM&H/U. Measure resistance between ABSCM&H/U terminals. <i>Terminals</i> <i>No. 22 — No. 23:</i>	Is the measured value more than 1 MΩ?	Go to step 4.	Replace ABSCM&H/U. <Ref. to ABS-6, ABS Control Module and Hydraulic Control Unit (ABSCM&H/U).>
4 CHECK WIRING HARNESS. Measure resistance between connector (F45) and chassis ground. <i>Connector & terminal</i> <i>(F45) No. 8 — Chassis ground:</i>	Is the measured value less than 0.5 Ω?	Go to step 5.	Repair harness.
5 CHECK WIRING HARNESS. 1) Connect connector to ABSCM&H/U. 2) Measure resistance between connector (F45) and chassis ground. <i>Connector & terminal</i> <i>(F45) No. 8 — Chassis ground:</i>	Is the measured value more than 1 MΩ?	Go to step 6.	Repair harness.
6 CHECK POOR CONTACT IN ABSCM&H/U CONNECTOR.	Is there poor contact in ABSCM&H/U connector?	Repair connector.	Replace ABSCM&H/U. <Ref. to ABS-6, ABS Control Module and Hydraulic Control Unit (ABSCM&H/U).>

DIAGNOSTICS CHART WITH SUBARU SELECT MONITOR

ABS (DIAGNOSTICS)

C: DTC 21 OPEN OR SHORT CIRCUIT IN FRONT RIGHT ABS SENSOR CIRCUIT

NOTE:

For the diagnostic procedure, refer to DTC 27. <Ref. to ABS-86, DTC 27 OPEN OR SHORT CIRCUIT IN REAR LEFT ABS SENSOR CIRCUIT, Diagnostics Chart with Subaru Select Monitor.>

D: DTC 23 OPEN OR SHORT CIRCUIT IN FRONT LEFT ABS SENSOR CIRCUIT

NOTE:

For the diagnostic procedure, refer to DTC 27. <Ref. to ABS-86, DTC 27 OPEN OR SHORT CIRCUIT IN REAR LEFT ABS SENSOR CIRCUIT, Diagnostics Chart with Subaru Select Monitor.>

E: DTC 25 OPEN OR SHORT CIRCUIT IN REAR RIGHT ABS SENSOR CIRCUIT

NOTE:

For the diagnostic procedure, refer to DTC 27. <Ref. to ABS-86, DTC 27 OPEN OR SHORT CIRCUIT IN REAR LEFT ABS SENSOR CIRCUIT, Diagnostics Chart with Subaru Select Monitor.>

DIAGNOSTICS CHART WITH SUBARU SELECT MONITOR

ABS (DIAGNOSTICS)

MEMO:

DIAGNOSTICS CHART WITH SUBARU SELECT MONITOR

ABS (DIAGNOSTICS)

F: DTC 27 OPEN OR SHORT CIRCUIT IN REAR LEFT ABS SENSOR CIRCUIT

DIAGNOSIS:

- Faulty ABS sensor (Broken wire, input voltage too high)
- Faulty harness connector

TROUBLE SYMPTOM:

- ABS does not operate.

WIRING DIAGRAM:

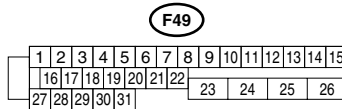
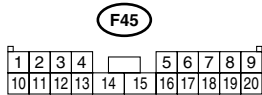
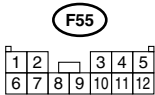
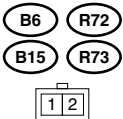
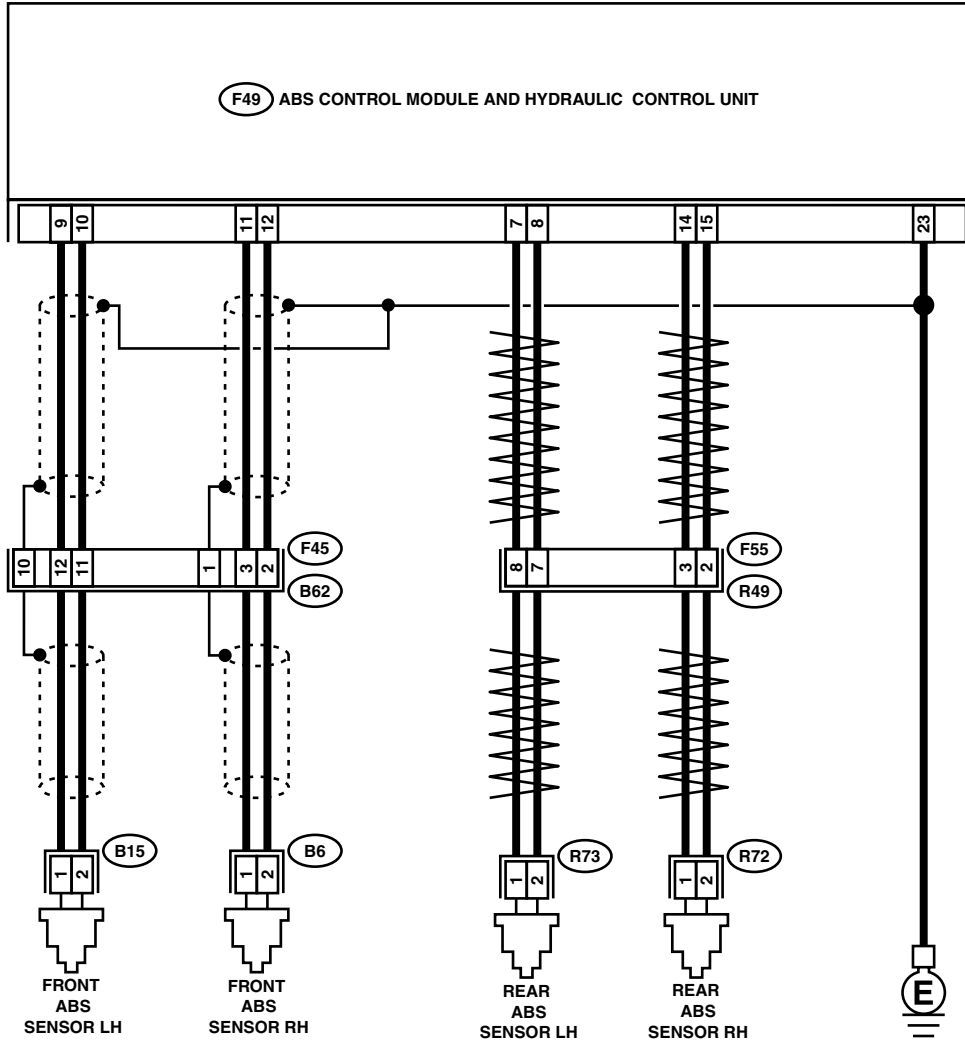

ABS00293

DIAGNOSTICS CHART WITH SUBARU SELECT MONITOR

ABS (DIAGNOSTICS)

Step	Check	Yes	No
1 CHECK OUTPUT OF ABS SENSOR USING SELECT MONITOR. 1) Select "Current data display & Save" on the select monitor. 2) Read the ABS sensor output corresponding to the faulty system in the select monitor data display mode.	Does the speed indicated on the display change in response to the speedometer reading during acceleration/deceleration when the steering wheel is in the straight-ahead position?	Go to step 2.	Go to step 8.
2 CHECK INSTALLATION OF ABS SENSOR.	Are the ABS sensor installation bolts tightened to 33 N·m (3.4 kgf-m, 25 ft-lb)?	Go to step 3.	Tighten ABS sensor installation bolts securely.
3 CHECK ABS SENSOR GAP. Measure tone wheel to ABS sensor piece gap over entire perimeter of the wheel. Is the measured value within the specified range?	Is the measured value within the range indicated below? Front wheel 0.3 — 0.8 mm (0.012 — 0.031 in) and Rear wheel 0.44 — 0.94 mm (0.0173 — 0.0370 in)	Go to step 4.	Adjust the gap. NOTE: Adjust the gap using spacers (Part No. 26755AA000). If spacers cannot correct the gap, replace worn sensor or worn tone wheel.
4 CHECK TONE WHEEL RUNOUT. Measure tone wheel runout.	Is the measured value less than 0.05 mm (0.0020 in)?	Go to step 5.	Replace tone wheel. Front: <Ref. to ABS-19, Front Tone Wheel.> Rear: <Ref. to ABS-20, Rear Tone Wheel.>
5 CHECK POOR CONTACT IN CONNECTORS. Turn ignition switch to OFF.	Is there poor contact in connectors between ABSCM&H/U and ABS sensor?	Repair connector.	Go to step 6.
6 CHECK ABSCM&H/U. 1) Connect all connectors. 2) Erase the memory. 3) Perform inspection mode. 4) Read out the DTC.	Is the same DTC still being output?	Replace ABSCM&H/U. <Ref. to ABS-6, ABS Control Module and Hydraulic Control Unit (ABSCM&H/U).>	Go to step 7.
7 CHECK ANY OTHER DTC APPEARANCE.	Are other DTC being output?	Proceed with the diagnosis corresponding to the DTC.	A temporary poor contact. NOTE: Check harness and connectors between ABSCM&H/U and ABS sensor.
8 CHECK ABS SENSOR. 1) Turn ignition switch to OFF. 2) Disconnect connector from ABS sensor. 3) Measure resistance of ABS sensor connector terminals. Terminal <i>Front RH No. 1 — No. 2:</i> <i>Front LH No. 1 — No. 2:</i> <i>Rear RH No. 1 — No. 2:</i> <i>Rear LH No. 1 — No. 2:</i>	Is the measured value within 1 to 1.5 kΩ?	Go to step 9.	Replace ABS sensor. Front: <Ref. to ABS-12, Front ABS Sensor.> Rear: <Ref. to ABS-15, Rear ABS Sensor.>

DIAGNOSTICS CHART WITH SUBARU SELECT MONITOR

ABS (DIAGNOSTICS)

Step	Check	Yes	No
<p>9 CHECK BATTERY SHORT OF ABS SENSOR.</p> <p>1) Disconnect connector from ABSCM&H/U. 2) Measure voltage between ABS sensor and chassis ground.</p> <p>Terminal Front RH No. 1 (+) — Chassis ground (-): Front LH No. 1 (+) — Chassis ground (-): Rear RH No. 1 (+) — Chassis ground (-): Rear LH No. 1 (+) — Chassis ground (-):</p>	Is the measured value less than 1 V?	Go to step 10.	Replace ABS sensor. Front: <Ref. to ABS-12, Front ABS Sensor.> Rear: <Ref. to ABS-15, Rear ABS Sensor.>
<p>10 CHECK BATTERY SHORT OF ABS SENSOR.</p> <p>1) Turn ignition switch to ON. 2) Measure voltage between ABS sensor and chassis ground.</p> <p>Terminal Front RH No. 1 (+) — Chassis ground (-): Front LH No. 1 (+) — Chassis ground (-): Rear RH No. 1 (+) — Chassis ground (-): Rear LH No. 1 (+) — Chassis ground (-):</p>	Is the measured value less than 1 V?	Go to step 11.	Replace ABS sensor. Front: <Ref. to ABS-12, Front ABS Sensor.> Rear: <Ref. to ABS-15, Rear ABS Sensor.>
<p>11 CHECK HARNESS/CONNECTOR BETWEEN ABSCM&H/U AND ABS SENSOR.</p> <p>1) Turn ignition switch to OFF. 2) Connect connector to ABS sensor. 3) Measure resistance between ABSCM&H/U connector terminals.</p> <p>Connector & terminal DTC 21 / (F49) No. 11 — No. 12: DTC 23 / (F49) No. 9 — No. 10: DTC 25 / (F49) No. 14 — No. 15: DTC 27 / (F49) No. 7 — No. 8:</p>	Is the measured value within 1 to 1.5 kΩ?	Go to step 12.	Repair harness/connector between ABSCM&H/U and ABS sensor.
<p>12 CHECK BATTERY SHORT OF HARNESS.</p> <p>Measure voltage between ABSCM&H/U connector and chassis ground.</p> <p>Connector & terminal DTC 21 / (F49) No. 11 (+) — Chassis ground (-): DTC 23 / (F49) No. 9 (+) — Chassis ground (-): DTC 25 / (F49) No. 14 (+) — Chassis ground (-): DTC 27 / (F49) No. 7 (+) — Chassis ground (-):</p>	Is the measured value less than 1 V?	Go to step 13.	Repair harness between ABSCM&H/U and ABS sensor.

DIAGNOSTICS CHART WITH SUBARU SELECT MONITOR

ABS (DIAGNOSTICS)

Step	Check	Yes	No
13 CHECK BATTERY SHORT OF HARNESS. 1) Turn ignition switch to ON. 2) Measure voltage between ABSCM&H/U connector and chassis ground. Connector & terminal <i>DTC 21 / (F49) No. 11 (+) — Chassis ground (-):</i> <i>DTC 23 / (F49) No. 9 (+) — Chassis ground (-):</i> <i>DTC 25 / (F49) No. 14 (+) — Chassis ground (-):</i> <i>DTC 27 / (F49) No. 7 (+) — Chassis ground (-):</i>	Is the measured value less than 1 V?	Go to step 14.	Repair harness between ABSCM&H/U and ABS sensor.
14 CHECK INSTALLATION OF ABS SENSOR.	Are the ABS sensor installation bolts tightened to 33 N·m (3.4 kgf-m, 25 ft-lb)?	Go to step 15.	Tighten ABS sensor installation bolts securely.
15 CHECK ABS SENSOR GAP. Measure tone wheel to ABS sensor piece gap over entire perimeter of the wheel.	Is the measured value within the range indicated below? Front wheel 0.3 — 0.8 mm (0.012 — 0.031 in) and Rear wheel 0.44 — 0.94 mm (0.0173 — 0.0370 in)	Go to step 16.	Adjust the gap. NOTE: Adjust the gap using spacers (Part No. 26755AA000). If spacers cannot correct the gap, replace worn sensor or worn tone wheel.
16 CHECK TONE WHEEL RUNOUT. Measure tone wheel runout.	Is the measured value less than 0.05 mm (0.0020 in)?	Go to step 17.	Replace tone wheel. Front: <Ref. to ABS-19, Front Tone Wheel.> Rear: <Ref. to ABS-20, Rear Tone Wheel.>
17 CHECK GROUND SHORT OF ABS SENSOR. 1) Turn ignition switch to ON. 2) Measure resistance between ABS sensor and chassis ground. Terminal <i>Front RH No. 1 — Chassis ground:</i> <i>Front LH No. 1 — Chassis ground:</i> <i>Rear RH No. 1 — Chassis ground:</i> <i>Rear LH No. 1 — Chassis ground:</i>	Is the measured value more than 1 MΩ?	Go to step 18.	Replace ABS sensor and ABSCM&H/U. Front: <Ref. to ABS-12, Front ABS Sensor.> Rear: <Ref. to ABS-15, Rear ABS Sensor.> and <Ref. to ABS-6, ABS Control Module and Hydraulic Control Unit (ABSCM&H/U).>
18 CHECK GROUND SHORT OF HARNESS. 1) Turn ignition switch to OFF. 2) Connect connector to ABS sensor. 3) Measure resistance between ABSCM&H/U connector terminal and chassis ground. Connector & terminal <i>DTC 21 / (F49) No. 11 — Chassis ground:</i> <i>DTC 23 / (F49) No. 9 — Chassis ground:</i> <i>DTC 25 / (F49) No. 14 — Chassis ground:</i> <i>DTC 27 / (F49) No. 7 — Chassis ground:</i>	Is the measured value more than 1 MΩ?	Go to step 19.	Repair harness between ABSCM&H/U and ABS sensor. And replace ABSCM&H/U. <Ref. to ABS-6, ABS Control Module and Hydraulic Control Unit (ABSCM&H/U).>

DIAGNOSTICS CHART WITH SUBARU SELECT MONITOR

ABS (DIAGNOSTICS)

Step	Check	Yes	No
19 CHECK POOR CONTACT IN CONNECTORS.	Is there poor contact in connectors between ABSCM&H/U and ABS sensor?	Repair connector.	Go to step 20 .
20 CHECK ABSCM&H/U. 1) Connect all connectors. 2) Erase the memory. 3) Perform inspection mode. 4) Read out the DTC.	Is the same DTC still being output?	Replace ABSCM&H/U.	Go to step 21 .
21 CHECK ANY OTHER DTC APPEARANCE.	Are other DTC being output?	Proceed with the diagnosis corresponding to the DTC.	A temporary poor contact. NOTE: Check harness and connectors between AB-SCM&H/U and ABS sensor.

G: DTC 22 FRONT RIGHT ABNORMAL ABS SENSOR SIGNAL

NOTE:

For the diagnostic procedure, refer to DTC 28. <Ref. to ABS-92, DTC 28 REAR LEFT ABNORMAL ABS SENSOR SIGNAL, Diagnostics Chart with Subaru Select Monitor.>

H: DTC 24 FRONT LEFT ABNORMAL ABS SENSOR SIGNAL

NOTE:

For the diagnostic procedure, refer to DTC 28. <Ref. to ABS-92, DTC 28 REAR LEFT ABNORMAL ABS SENSOR SIGNAL, Diagnostics Chart with Subaru Select Monitor.>

I: DTC 26 REAR RIGHT ABNORMAL ABS SENSOR SIGNAL

NOTE:

For the diagnostic procedure, refer to DTC 28. <Ref. to ABS-92, DTC 28 REAR LEFT ABNORMAL ABS SENSOR SIGNAL, Diagnostics Chart with Subaru Select Monitor.>

DIAGNOSTICS CHART WITH SUBARU SELECT MONITOR

ABS (DIAGNOSTICS)

J: DTC 28 REAR LEFT ABNORMAL ABS SENSOR SIGNAL

DIAGNOSIS:

- Faulty ABS sensor signal (noise, irregular signal, etc.)
- Faulty harness/connector

TROUBLE SYMPTOM:

- ABS does not operate.

WIRING DIAGRAM:

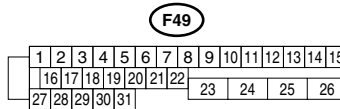
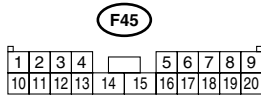
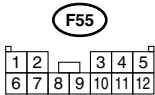
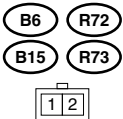
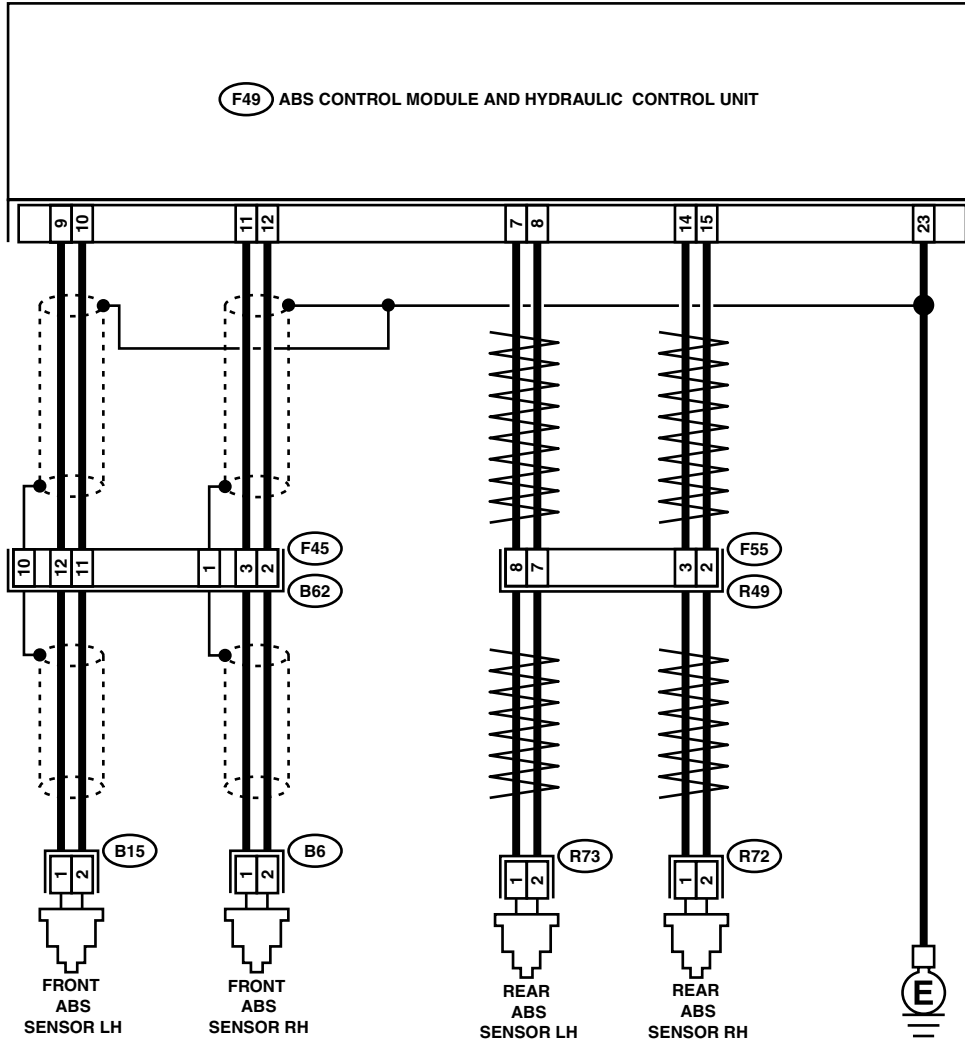

ABS00293

DIAGNOSTICS CHART WITH SUBARU SELECT MONITOR

ABS (DIAGNOSTICS)

Step	Check	Yes	No
1 CHECK OUTPUT OF ABS SENSOR USING SELECT MONITOR. 1) Select "Current data display & Save" on the select monitor. 2) Read the ABS sensor output corresponding to the faulty system in the select monitor data display mode.	Does the speed indicated on the display change in response to the speedometer reading during acceleration/deceleration when the steering wheel is in the straight-ahead position?	Go to step 2.	Go to step 8.
2 CHECK POOR CONTACT IN CONNECTORS. Turn ignition switch to OFF.	Is there poor contact in connectors between ABSCM&H/U and ABS sensor?	Repair connector.	Go to step 3.
3 CHECK SOURCES OF SIGNAL NOISE.	Is the car telephone or the wireless transmitter properly installed?	Go to step 4.	Properly install the car telephone or the wireless transmitter.
4 CHECK SOURCES OF SIGNAL NOISE.	Are noise sources (such as an antenna) installed near the sensor harness?	Install the noise sources apart from the sensor harness.	Go to step 5.
5 CHECK SHIELD CIRCUIT. 1) Turn ignition switch to OFF. 2) Connect all connectors. 3) Measure resistance between shield connector and chassis ground. Connector & terminal DTC 22 / (B62) No. 1 — Chassis ground: DTC 24 / (B62) No. 10 — Chassis ground: NOTE: For the DTC 26 and 28 : Go to step 6.	Is the measured value less than 0.5 Ω?	Go to step 6.	Repair shield harness.
6 CHECK ABSCM&H/U. 1) Connect all connectors. 2) Erase the memory. 3) Perform inspection mode. 4) Read out the DTC.	Is the same DTC still being output?	Replace ABSCM&H/U. <Ref. to ABS-6, ABS Control Module and Hydraulic Control Unit (ABSCM&H/U).>	Go to step 7.
7 CHECK ANY OTHER DTC APPEARANCE.	Are other DTC being output?	Proceed with the diagnosis corresponding to the DTC.	A temporary noise interference.
8 CHECK INSTALLATION OF ABS SENSOR.	Are the ABS sensor installation bolts tightened to 33 N·m (3.4 kgf-m, 25 ft-lb)?	Go to step 9.	Tighten ABS sensor installation bolts securely.
9 CHECK ABS SENSOR GAP. Measure tone wheel to ABS sensor piece gap over entire perimeter of the wheel.	Is the measured value within the range indicated below? Front wheel 0.3 — 0.8 mm (0.012 — 0.031 in) and Rear wheel 0.44 — 0.94 mm (0.0173 — 0.0370 in)	Go to step 10.	Adjust the gap. NOTE: Adjust the gap using spacer (Part No. 26755AA000). If spacers cannot correct the gap, replace worn sensor or worn tone wheel.
10 PREPARE OSCILLOSCOPE.	Is an oscilloscope available?	Go to step 11.	Go to step 12.

DIAGNOSTICS CHART WITH SUBARU SELECT MONITOR

ABS (DIAGNOSTICS)

Step	Check	Yes	No
11 CHECK ABS SENSOR SIGNAL. 1) Lift-up the vehicle. 2) Turn ignition switch to OFF. 3) Connect the oscilloscope to the connector. 4) Turn ignition switch to ON. 5) Rotate wheels and measure voltage at specified frequency. <Ref. to ABS-15, WAVEFORM, Control Module I/O Signal.> NOTE: When this inspection is completed, the ABS-CM&H/U sometimes stores the trouble code 29. Connector & terminal <i>DTC 22 / (B62) No. 3 (+) — No. 2 (-):</i> <i>DTC 24 / (B62) No. 12 (+) — No. 11 (-):</i> <i>DTC 26 / (F55) No. 3 (+) — No. 2 (-):</i> <i>DTC 28 / (F55) No. 8 (+) — No. 7 (-):</i>	Is the oscilloscope pattern the same as that shown in the figure?	Go to step 15.	Go to step 12.
12 CHECK CONTAMINATION OF ABS SENSOR OR TONE WHEEL. Remove disc rotor from hub in accordance with diagnostic trouble code.	Is the ABS sensor piece or the tone wheel contaminated by mud or other foreign matter?	Thoroughly remove dirt or other foreign matter.	Go to step 13.
13 CHECK DAMAGE OF ABS SENSOR OR TONE WHEEL.	Are there broken or damaged in the ABS sensor piece or the tone wheel?	Replace ABS sensor or tone wheel. Front: <Ref. to ABS-12, Front ABS Sensor.> Rear: <Ref. to ABS-15, Rear ABS Sensor.> and Front: <Ref. to ABS-19, Front Tone Wheel.> Rear: <Ref. to ABS-20, Rear Tone Wheel.>	Go to step 14.
14 CHECK TONE WHEEL RUNOUT. Measure tone wheel runout.	Is the measured value less than 0.05 mm (0.0020 in)?	Go to step 15.	Replace tone wheel. Front: <Ref. to ABS-19, Front Tone Wheel.> Rear: <Ref. to ABS-20, Rear Tone Wheel.>
15 CHECK RESISTANCE OF ABS SENSOR. 1) Turn ignition switch to OFF. 2) Disconnect connector from ABS sensor. 3) Measure resistance between ABS sensor connector terminals. Terminal <i>Front RH No. 1 — No. 2:</i> <i>Front LH No. 1 — No. 2:</i> <i>Rear RH No. 1 — No. 2:</i> <i>Rear LH No. 1 — No. 2:</i>	Is the measured value within 1 to 1.5 kΩ?	Go to step 16.	Replace ABS sensor. Front: <Ref. to ABS-12, Front ABS Sensor.> Rear: <Ref. to ABS-15, Rear ABS Sensor.>

DIAGNOSTICS CHART WITH SUBARU SELECT MONITOR

ABS (DIAGNOSTICS)

Step	Check	Yes	No
16 CHECK GROUND SHORT OF ABS SENSOR. Measure resistance between ABS sensor and chassis ground. <i>Terminal</i> <i>Front RH No. 1 — Chassis ground:</i> <i>Front LH No. 1 — Chassis ground:</i> <i>Rear RH No. 1 — Chassis ground:</i> <i>Rear LH No. 1 — Chassis ground:</i>	Is the measured value more than 1 MΩ?	Go to step 17.	Replace ABS sensor. Front: <Ref. to ABS-12, Front ABS Sensor.> Rear: <Ref. to ABS-15, Rear ABS Sensor.>
17 CHECK HARNESS/CONNECTOR BETWEEN ABSCM&H/U AND ABS SENSOR. 1) Connect connector to ABS sensor. 2) Disconnect connector from ABSCM&H/U. 3) Measure resistance at ABSCM&H/U connector terminals. <i>Connector & terminal</i> <i>DTC 22 / (F49) No. 11 — No. 12:</i> <i>DTC 24 / (F49) No. 9 — No. 10:</i> <i>DTC 26 / (F49) No. 14 — No. 15:</i> <i>DTC 28 / (F49) No. 7 — No. 8:</i>	Is the measured value within 1 to 1.5 kΩ?	Go to step 18.	Repair harness/connector between ABSCM&H/U and ABS sensor.
18 CHECK GROUND SHORT OF HARNESS. Measure resistance between ABSCM&H/U connector and chassis ground. <i>Connector & terminal</i> <i>DTC 22 / (F49) No. 11 — Chassis ground:</i> <i>DTC 24 / (F49) No. 9 — Chassis ground:</i> <i>DTC 26 / (F49) No. 14 — Chassis ground:</i> <i>DTC 28 / (F49) No. 7 — Chassis ground:</i>	Is the measured value more than 1 MΩ?	Go to step 19.	Repair harness/connector between ABSCM&H/U and ABS sensor.
19 CHECK GROUND CIRCUIT OF ABSCM&H/U. Measure resistance between ABSCM&H/U and chassis ground. <i>Connector & terminal</i> <i>(F49) No. 23 — GND:</i>	Is the measured value less than 0.5 Ω?	Go to step 20.	Repair ABSCM&H/U ground harness.
20 CHECK POOR CONTACT IN CONNECTORS.	Is there poor contact in connectors between ABSCM&H/U and ABS sensor?	Repair connector.	Go to step 21.
21 CHECK SOURCES OF SIGNAL NOISE.	Is the car telephone or the wireless transmitter properly installed?	Go to step 22.	Properly install the car telephone or the wireless transmitter.
22 CHECK SOURCES OF SIGNAL NOISE.	Are noise sources (such as an antenna) installed near the sensor harness?	Install the noise sources apart from the sensor harness.	Go to step 23.
23 CHECK SHIELD CIRCUIT. 1) Connect all connectors. 2) Measure resistance between shield connector and chassis ground. <i>Connector & terminal</i> <i>DTC 22 / (B62) No. 1 — Chassis ground:</i> <i>DTC 24 / (B62) No. 10 — Chassis ground:</i> NOTE: For the DTC 26 and 28 : Go to step 24.	Is the measured value less than 0.5 Ω?	Go to step 24.	Repair shield harness.

DIAGNOSTICS CHART WITH SUBARU SELECT MONITOR

ABS (DIAGNOSTICS)

Step	Check	Yes	No
24 CHECK ABSCM&H/U. 1) Connect all connectors. 2) Erase the memory. 3) Perform inspection mode. 4) Read out the DTC.	Is the same DTC still being output?	Replace ABSCM&H/U. <Ref. to ABS-6, ABS Control Module and Hydraulic Control Unit (ABSCM&H/U).>	Go to step 25 .
25 CHECK ANY OTHER DTC APPEARANCE.	Are other DTC being output?	Proceed with the diagnosis corresponding to the DTC.	A temporary noise interference.

DIAGNOSTICS CHART WITH SUBARU SELECT MONITOR

ABS (DIAGNOSTICS)

MEMO:

DIAGNOSTICS CHART WITH SUBARU SELECT MONITOR

ABS (DIAGNOSTICS)

K: DTC 29 ABNORMAL ABS SENSOR SIGNAL ON ANY ONE OF FOUR SENSOR

DIAGNOSIS:

- Faulty ABS sensor signal (noise, irregular signal, etc.)
- Faulty tone wheel
- Wheels turning freely for a long time

TROUBLE SYMPTOM:

- ABS does not operate.

WIRING DIAGRAM:

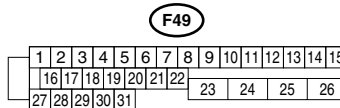
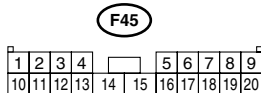
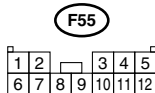
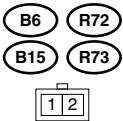
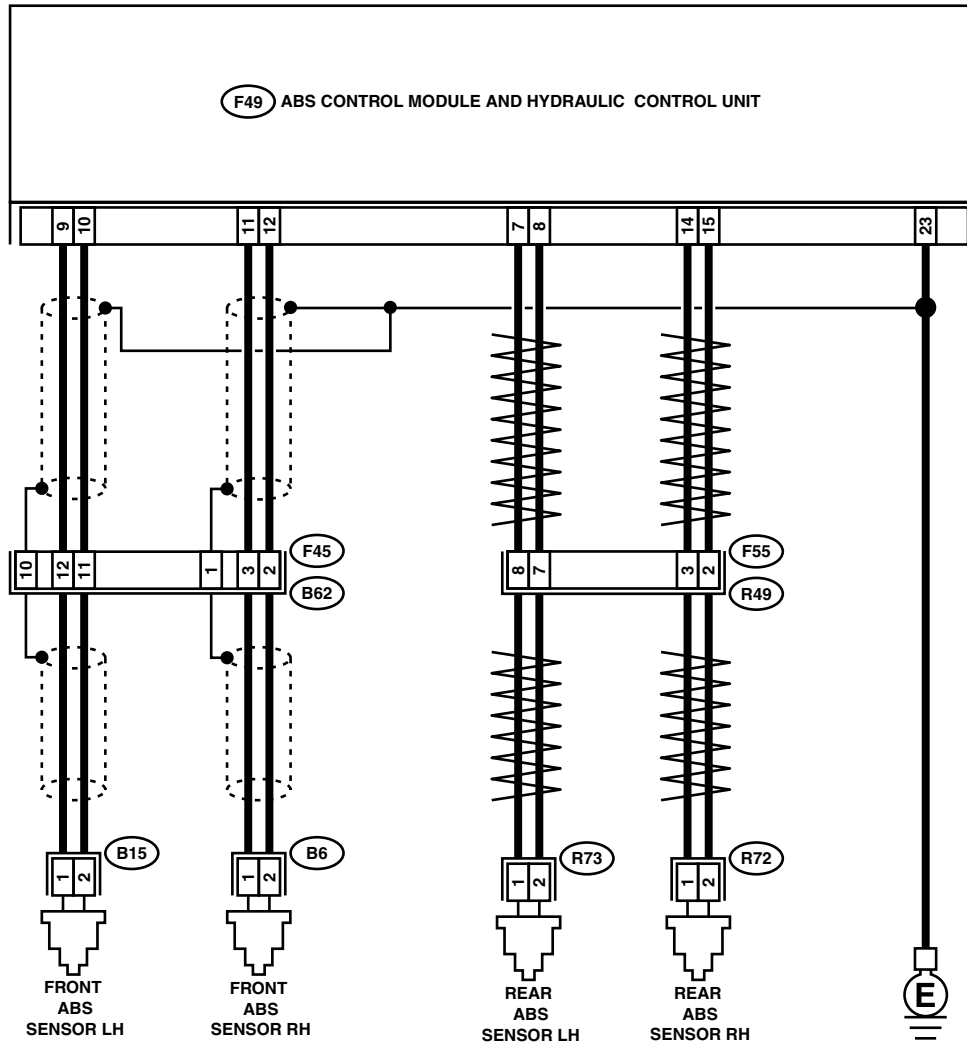

DIAGNOSTICS CHART WITH SUBARU SELECT MONITOR

ABS (DIAGNOSTICS)

Step	Check	Yes	No
1 CHECK WHEELS FOR FREE TURNING. Check if the wheels have been turned freely for more than one minute, such as when the vehicle is jacked-up, under full-lock cornering or when tire is not in contact with road surface.	Have wheels turned freely?	The ABS is normal. Erase the diagnostic trouble code. NOTE: When the wheels turn freely for a long time, such as when the vehicle is towed or jacked-up, or when steering wheel is continuously turned all the way, this trouble code may sometimes occur.	Go to step 2.
2 CHECK TIRE SPECIFICATIONS. Turn ignition switch to OFF.	Are the tire specifications correct?	Go to step 3.	Replace tire.
3 CHECK WEAR OF TIRE.	Is the tire worn excessively?	Replace tire.	Go to step 4.
4 CHECK TIRE PRESSURE.	Is the tire pressure correct?	Go to step 5.	Adjust tire pressure.
5 CHECK INSTALLATION OF ABS SENSOR.	Are the ABS sensor installation bolts tightened to 33 N·m (3.4 kgf-m, 25 ft-lb)?	Go to step 6.	Tighten ABS sensor installation bolts securely.
6 CHECK ABS SENSOR GAP. Measure tone wheel to ABS sensor piece gap over entire perimeter of the wheel.	Is the measured value within the range indicated below? Front wheel 0.3 — 0.8 mm (0.012 — 0.031 in) and Rear wheel 0.44 — 0.94 mm (0.0173 — 0.0370 in)	Go to step 7.	Adjust the gap. NOTE: Adjust the gap using spacer (Part No. 26755AA000). If spacers cannot correct the gap, replace worn sensor or worn tone wheel.
7 PREPARE OSCILLOSCOPE.	Is an oscilloscope available?	Go to step 8.	Go to step 9.
8 CHECK ABS SENSOR SIGNAL. 1) Lift up the vehicle. 2) Turn ignition switch to OFF. 3) Connect the oscilloscope to the connector (B62) in accordance with trouble code. 4) Turn ignition switch to ON. 5) Rotate wheels and measure voltage at specified frequency. <Ref. to ABS-15, WAVEFORM, Control Module I/O Signal.> NOTE: When this inspection is completed, the ABS-CM&H/U sometimes stores the DTC 29. Connector & terminal (B62) No. 3 (+) — No. 2 (-) (Front RH): (B62) No. 12 (+) — No. 11 (-) (Front LH): (F55) No. 3 (+) — No. 2 (-) (Rear RH): (F55) No. 8 (+) — No. 7 (-) (Rear LH):	Is the oscilloscope pattern the same as that shown in the figure?	Go to step 12.	Go to step 9.
9 CHECK CONTAMINATION OF ABS SENSOR OR TONE WHEEL. Remove disc rotor from hub.	Is the ABS sensor piece or the tone wheel contaminated by mud or other foreign matter?	Thoroughly remove mud or other foreign matter.	Go to step 10.

DIAGNOSTICS CHART WITH SUBARU SELECT MONITOR

ABS (DIAGNOSTICS)

Step	Check	Yes	No	
10	CHECK DAMAGE OF ABS SENSOR OR TONE WHEEL.	Are there broken or damaged teeth in the ABS sensor piece or the tone wheel?	Replace ABS sensor or tone wheel. Front: <Ref. to ABS-12, Front ABS Sensor.> Rear: <Ref. to ABS-15, Rear ABS Sensor.> and Front: <Ref. to ABS-19, Front Tone Wheel.> Rear: <Ref. to ABS-20, Rear Tone Wheel.>	Go to step 11.
11	CHECK TONE WHEEL RUNOUT. Measure tone wheel runout.	Is the measured value less than 0.05 mm (0.0020 in)?	Go to step 12.	Replace tone wheel. Front: <Ref. to ABS-19, Front Tone Wheel.> Rear: <Ref. to ABS-20, Rear Tone Wheel.>
12	CHECK ABSCM&H/U. 1) Turn ignition switch to OFF. 2) Connect all connectors. 3) Erase the memory. 4) Perform inspection mode. 5) Read out the DTC.	Is the same DTC still being output?	Replace ABSCM&H/U. <Ref. to ABS-6, ABS Control Module and Hydraulic Control Unit (ABSCM&H/U).>	Go to step 13.
13	CHECK ANY OTHER DTC APPEARANCE.	Are other DTC being output?	Proceed with the diagnosis corresponding to the DTC.	A temporary poor contact.

L: DTC 31 FRONT RIGHT INLET VALVE MALFUNCTION

NOTE:

For the diagnostic procedure, refer to DTC 37. <Ref. to ABS-102, DTC 37 REAR LEFT INLET VALVE MALFUNCTION, Diagnostics Chart with Subaru Select Monitor.>

M: DTC 33 FRONT LEFT INLET VALVE MALFUNCTION

NOTE:

For the diagnostic procedure, refer to DTC 37. <Ref. to ABS-102, DTC 37 REAR LEFT INLET VALVE MALFUNCTION, Diagnostics Chart with Subaru Select Monitor.>

N: DTC 35 REAR RIGHT INLET VALVE MALFUNCTION

NOTE:

For the diagnostic procedure, refer to DTC 37. <Ref. to ABS-102, DTC 37 REAR LEFT INLET VALVE MALFUNCTION, Diagnostics Chart with Subaru Select Monitor.>

DIAGNOSTICS CHART WITH SUBARU SELECT MONITOR

ABS (DIAGNOSTICS)

O: DTC 37 REAR LEFT INLET VALVE MALFUNCTION

DIAGNOSIS:

- Faulty harness/connector
- Faulty inlet solenoid valve

TROUBLE SYMPTOM:

- ABS does not operate.

WIRING DIAGRAM:

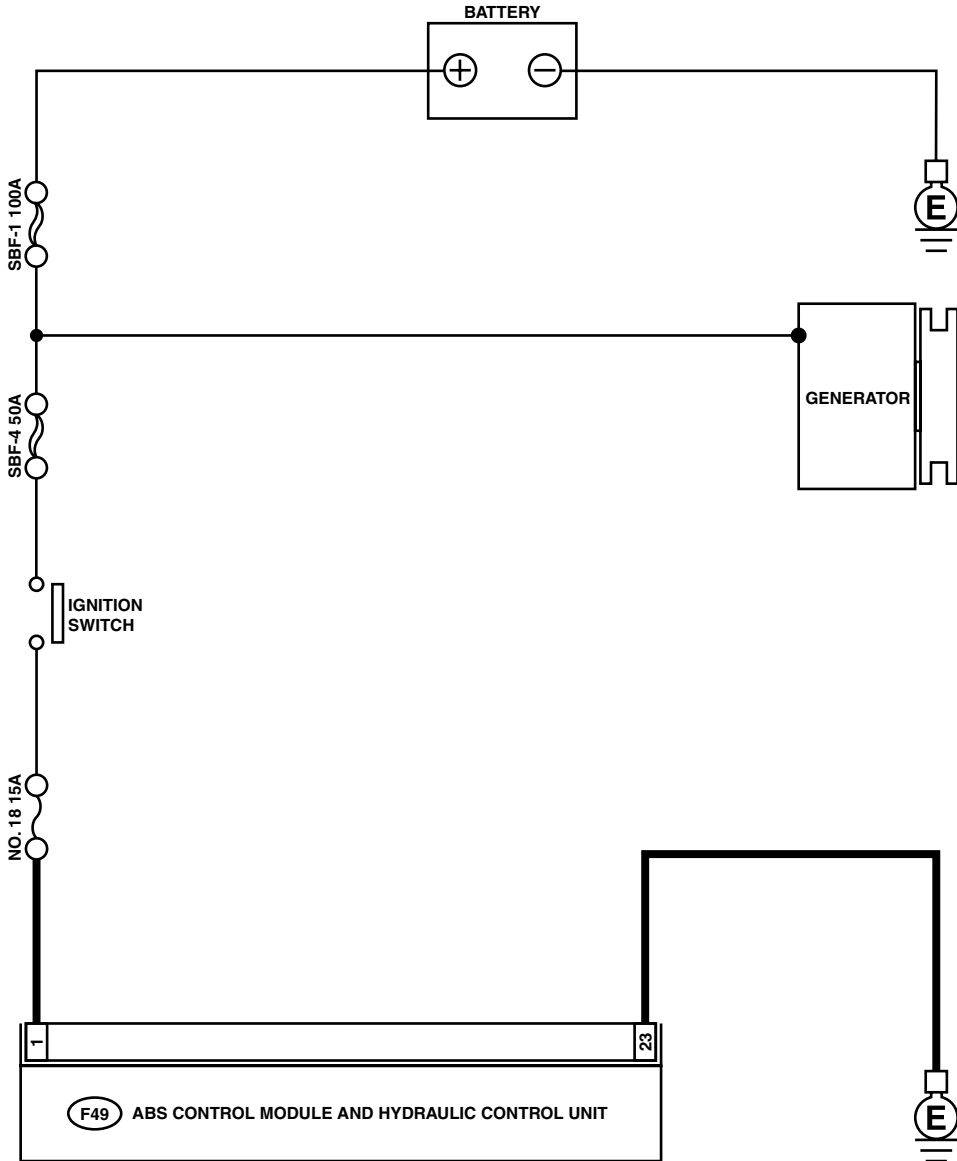

F49

1	2	3	4	5	6	7	8	9	10	11	12	13	14	15
16	17	18	19	20	21	22		23	24	25	26			
27	28	29	30	31										

ABS00294

DIAGNOSTICS CHART WITH SUBARU SELECT MONITOR

ABS (DIAGNOSTICS)

Step	Check	Yes	No
1 CHECK INPUT VOLTAGE OF ABSCM&H/U. 1) Turn ignition switch to OFF. 2) Disconnect connector from ABSCM&H/U. 3) Run the engine at idle. 4) Measure voltage between ABSCM&H/U connector and chassis ground. Connector & terminal (F49) No. 1 (+) — Chassis ground (-):	Is the measured value within 10 to 15 V?	Go to step 2.	Repair harness connector between battery, ignition switch and ABSCM&H/U.
2 CHECK GROUND CIRCUIT OF ABSCM&H/U. 1) Turn ignition switch to OFF. 2) Measure resistance between ABSCM&H/U connector and chassis ground. Connector & terminal (F49) No. 23 — Chassis ground:	Is the measured value less than 0.5 Ω?	Go to step 3.	Repair ABSCM&H/U ground harness.
3 CHECK POOR CONTACT IN CONNECTORS.	Is there poor contact in connectors between generator, battery and ABSCM&H/U?	Repair connector.	Go to step 4.
4 CHECK ABSCM&H/U. 1) Connect all connectors. 2) Erase the memory. 3) Perform inspection mode. 4) Read out the DTC.	Is the same DTC still being output?	Replace ABSCM&H/U. <Ref. to ABS-6, ABS Control Module and Hydraulic Control Unit (ABSCM&H/U).>	Go to step 5.
5 CHECK ANY OTHER DTC APPEARANCE.	Are other DTC being output?	Proceed with the diagnosis corresponding to the DTC.	A temporary poor contact.

DIAGNOSTICS CHART WITH SUBARU SELECT MONITOR

ABS (DIAGNOSTICS)

P: DTC 32 FRONT RIGHT OUTLET VALVE MALFUNCTION

NOTE:

For the diagnostic procedure, refer to DTC 38. <Ref. to ABS-106, DTC 38 REAR LEFT OUTLET VALVE MALFUNCTION, Diagnostics Chart with Subaru Select Monitor.>

Q: DTC 34 FRONT LEFT OUTLET VALVE MALFUNCTION

NOTE:

For the diagnostic procedure, refer to DTC 38. <Ref. to ABS-106, DTC 38 REAR LEFT OUTLET VALVE MALFUNCTION, Diagnostics Chart with Subaru Select Monitor.>

R: DTC 36 REAR RIGHT OUTLET VALVE MALFUNCTION

NOTE:

For the diagnostic procedure, refer to DTC 38. <Ref. to ABS-106, DTC 38 REAR LEFT OUTLET VALVE MALFUNCTION, Diagnostics Chart with Subaru Select Monitor.>

DIAGNOSTICS CHART WITH SUBARU SELECT MONITOR

ABS (DIAGNOSTICS)

MEMO:

DIAGNOSTICS CHART WITH SUBARU SELECT MONITOR

ABS (DIAGNOSTICS)

S: DTC 38 REAR LEFT OUTLET VALVE MALFUNCTION

DIAGNOSIS:

- Faulty harness/connector
- Faulty outlet solenoid valve

TROUBLE SYMPTOM:

- ABS does not operate.

WIRING DIAGRAM:

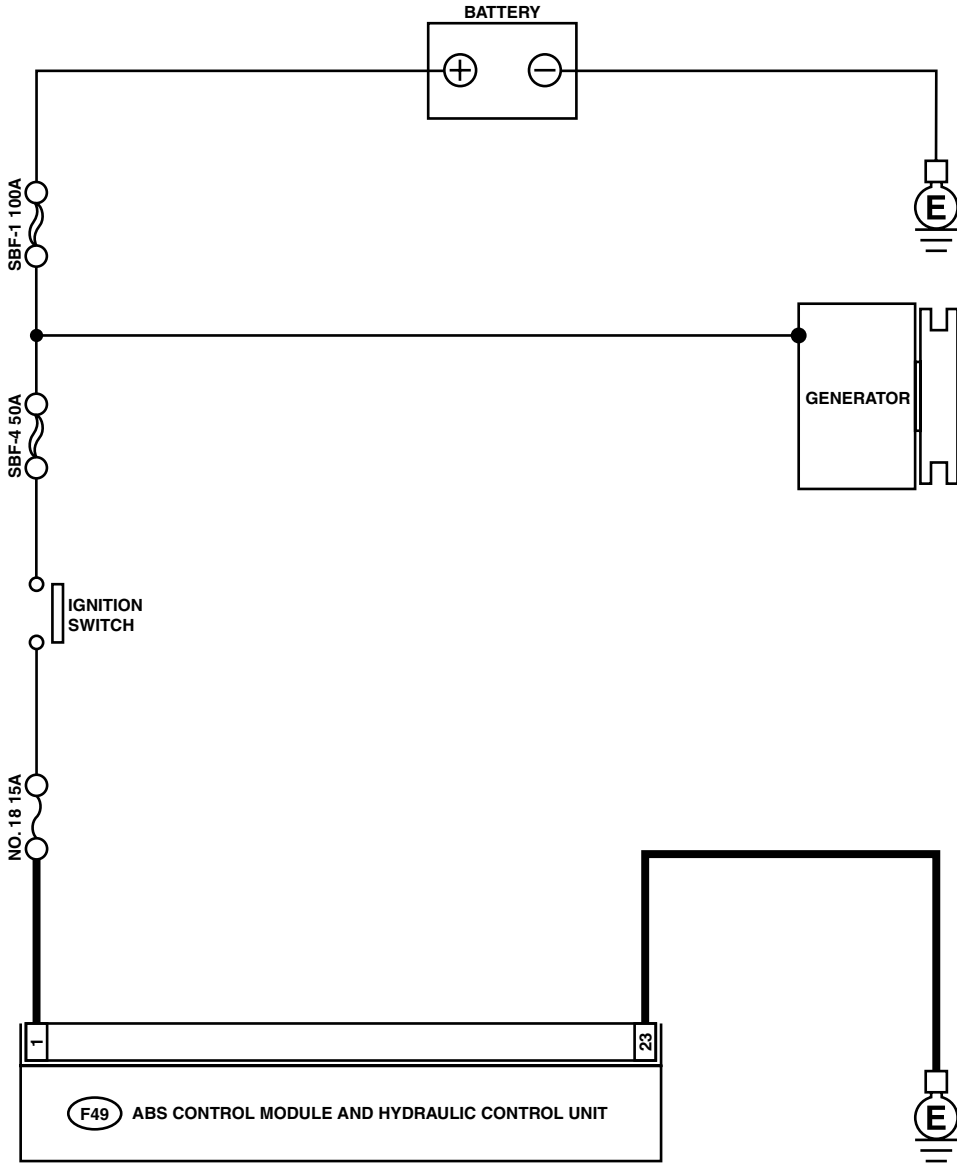

(F49)

1	2	3	4	5	6	7	8	9	10	11	12	13	14	15
16	17	18	19	20	21	22		23	24	25	26			
27	28	29	30	31										

ABS00294

DIAGNOSTICS CHART WITH SUBARU SELECT MONITOR

ABS (DIAGNOSTICS)

Step	Check	Yes	No
1 CHECK INPUT VOLTAGE OF ABSCM&H/U. 1) Turn ignition switch to OFF. 2) Disconnect connector from ABSCM&H/U. 3) Run the engine at idle. 4) Measure voltage between ABSCM&H/U connector and chassis ground. Connector & terminal (F49) No. 1 (+) — Chassis ground (-):	Is the measured value within 10 to 15 V?	Go to step 2.	Repair harness connector between battery, ignition switch and ABSCM&H/U.
2 CHECK GROUND CIRCUIT OF ABSCM&H/U. 1) Turn ignition switch to OFF. 2) Measure resistance between ABSCM&H/U connector and chassis ground. Connector & terminal (F49) No. 23 — Chassis ground:	Is the measured value less than 0.5 Ω?	Go to step 3.	Repair ABSCM&H/U ground harness.
3 CHECK POOR CONTACT IN CONNECTORS.	Is there poor contact in connectors between generator, battery and ABSCM&H/U?	Repair connector.	Go to step 4.
4 CHECK ABSCM&H/U. 1) Connect all connectors. 2) Erase the memory. 3) Perform inspection mode. 4) Read out the DTC.	Is the same DTC as in the current diagnosis still being output?	Replace ABSCM&H/U. <Ref. to ABS-6, ABS Control Module and Hydraulic Control Unit (ABSCM&H/U).>	Go to step 5.
5 CHECK ANY OTHER DTC APPEARANCE.	Are other DTC being output?	Proceed with the diagnosis corresponding to the DTC.	A temporary poor contact.

DIAGNOSTICS CHART WITH SUBARU SELECT MONITOR

ABS (DIAGNOSTICS)

T: DTC 41 ABS CONTROL MODULE MALFUNCTION

DIAGNOSIS:

- Faulty ABSCM&H/U

TROUBLE SYMPTOM:

- ABS does not operate.

WIRING DIAGRAM:

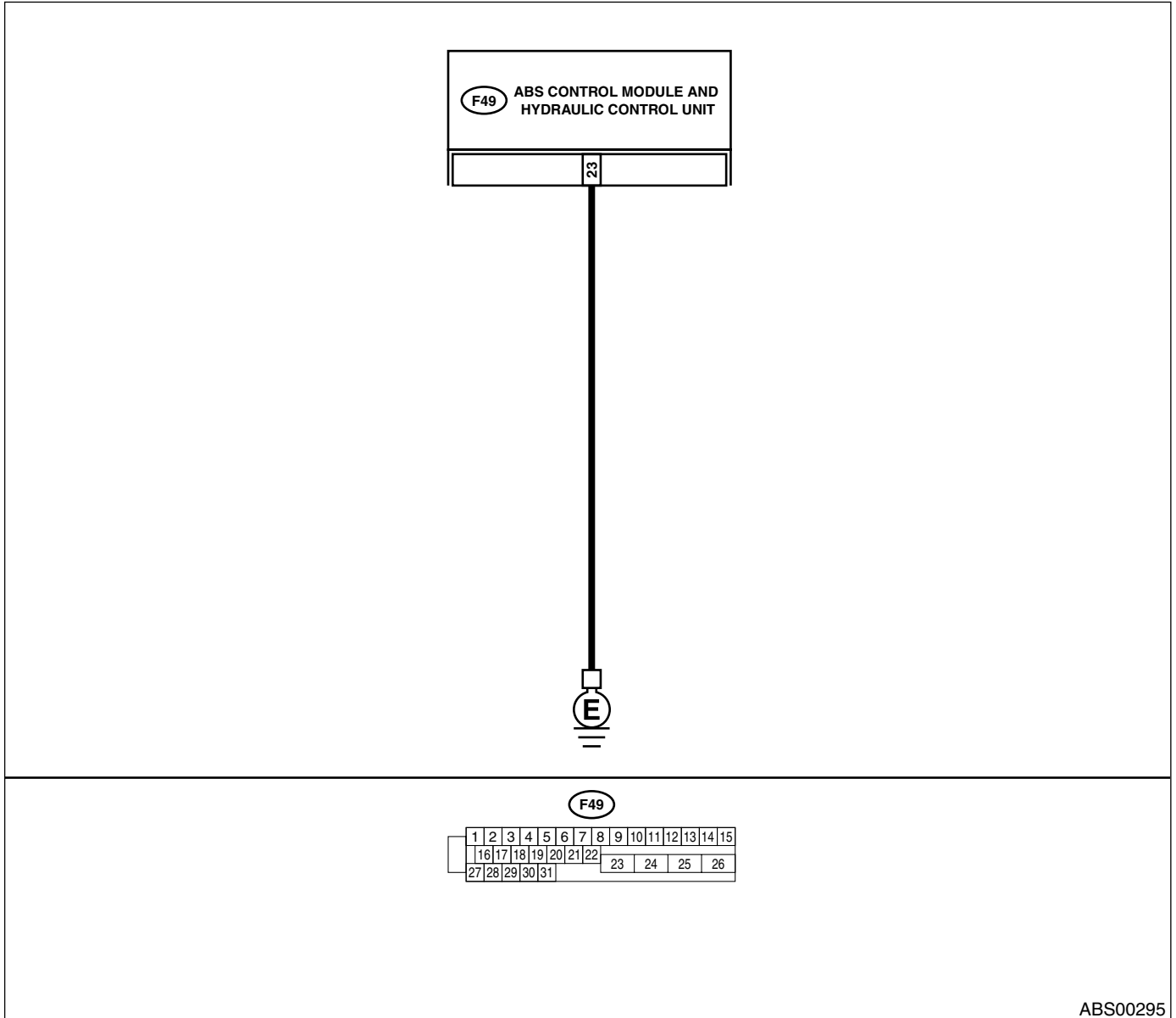

Step	Check	Yes	No	
1	CHECK GROUND CIRCUIT OF ABSCM&H/U. 1) Turn ignition switch to OFF. 2) Disconnect connector from ABSCM&H/U. 3) Measure resistance between ABSCM&H/U and chassis ground. Connector & terminal (F49) No. 23 — Chassis ground:	Is the measured value less than 0.5 Ω?	Go to step 2.	Repair ABSCM&H/U ground harness.
2	CHECK POOR CONTACT IN CONNECTORS.	Is there poor contact in connectors between battery, ignition switch and ABSCM&H/U?	Repair connector.	Go to step 3.

DIAGNOSTICS CHART WITH SUBARU SELECT MONITOR

ABS (DIAGNOSTICS)

Step	Check	Yes	No	
3	CHECK SOURCES OF SIGNAL NOISE.	Is the car telephone or the wireless transmitter properly installed?	Go to step 4.	Properly install the car telephone or the wireless transmitter.
4	CHECK SOURCES OF SIGNAL NOISE.	Are noise sources (such as an antenna) installed near the sensor harness?	Install the noise sources apart from the sensor harness.	Go to step 5.
5	CHECK ABSCM&H/U. 1) Turn ignition switch to OFF. 2) Connect all connectors. 3) Erase the memory. 4) Perform inspection mode. 5) Read out the DTC.	Is the same DTC as in the current diagnosis still being output?	Replace ABSCM&H/U. <Ref. to ABS-6, ABS Control Module and Hydraulic Control Unit (ABSCM&H/U).>	Go to step 6.
6	CHECK ANY OTHER DTC APPEARANCE.	Are other DTC being output?	Proceed with the diagnosis corresponding to the DTC.	A temporary poor contact.

DIAGNOSTICS CHART WITH SUBARU SELECT MONITOR

ABS (DIAGNOSTICS)

U: DTC 42 POWER SUPPLY VOLTAGE TOO LOW

DIAGNOSIS:

- Power source voltage of the ABSCM&H/U is low.

TROUBLE SYMPTOM:

- ABS does not operate.

WIRING DIAGRAM:

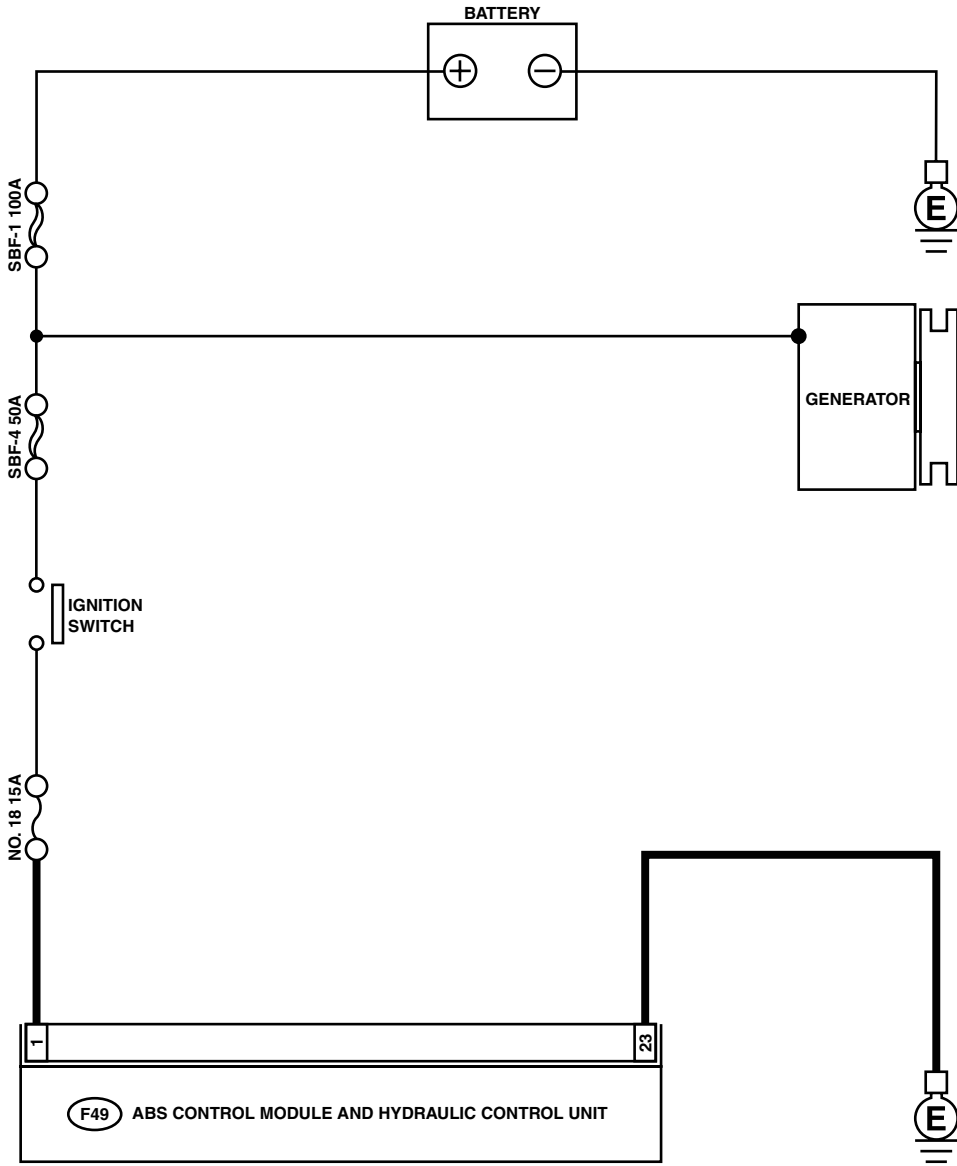

F49

1	2	3	4	5	6	7	8	9	10	11	12	13	14	15
16	17	18	19	20	21	22	23	24	25	26				
27	28	29	30	31										

ABS00294

DIAGNOSTICS CHART WITH SUBARU SELECT MONITOR

ABS (DIAGNOSTICS)

Step	Check	Yes	No
1 CHECK GENERATOR. 1) Start engine. 2) Idling after warm-up. 3) Measure voltage between generator B terminal and chassis ground. <i>Terminal</i> <i>Generator B terminal — Chassis ground:</i>	Is the measured value within 10 to 15 V?	Go to step 2.	i) Repair generator. ii) H4 engine model: iii) <Ref. to SC(H4SO)-15, Generator.> iv) H6 engine model: v) <Ref. to SC(H6DO)-14, Generator.>
2 CHECK BATTERY TERMINAL. Turn ignition switch to OFF.	Are the positive and negative battery terminals tightly clamped?	Go to step 3.	Tighten the clamp of terminal.
3 CHECK INPUT VOLTAGE OF ABSCM&H/U. 1) Disconnect connector from ABSCM&H/U. 2) Run the engine at idle. 3) Measure voltage between ABSCM&H/U connector and chassis ground. <i>Connector & terminal</i> <i>(F49) No. 1 (+) — Chassis ground (-):</i>	Is the measured value within 10 to 15 V?	Go to step 4.	Repair harness connector between battery, ignition switch and ABSCM&H/U.
4 CHECK GROUND CIRCUIT OF ABSCM&H/U. 1) Turn ignition switch to OFF. 2) Measure resistance between ABSCM&H/U connector and chassis ground. <i>Connector & terminal</i> <i>(F49) No. 23 — Chassis ground:</i>	Is the measured value less than 0.5 Ω?	Go to step 5.	Repair ABSCM&H/U ground harness.
5 CHECK POOR CONTACT IN CONNECTORS.	Is there poor contact in connectors between generator, battery and ABSCM&H/U?	Repair connector.	Go to step 6.
6 CHECK ABSCM&H/U. 1) Connect all connectors. 2) Erase the memory. 3) Perform inspection mode. 4) Read out the DTC.	Is the same DTC still being output?	Replace ABSCM&H/U. <Ref. to ABS-6, ABS Control Module and Hydraulic Control Unit (ABSCM&H/U).>	Go to step 7.
7 CHECK ANY OTHER DTC APPEARANCE.	Are other DTC being output?	Proceed with the diagnosis corresponding to the DTC.	A temporary poor contact.

DIAGNOSTICS CHART WITH SUBARU SELECT MONITOR

ABS (DIAGNOSTICS)

V: DTC 42 POWER SUPPLY VOLTAGE TOO HIGH

DIAGNOSIS:

- Power source voltage of the ABSCM&H/U is high.

TROUBLE SYMPTOM:

- ABS does not operate.

WIRING DIAGRAM:

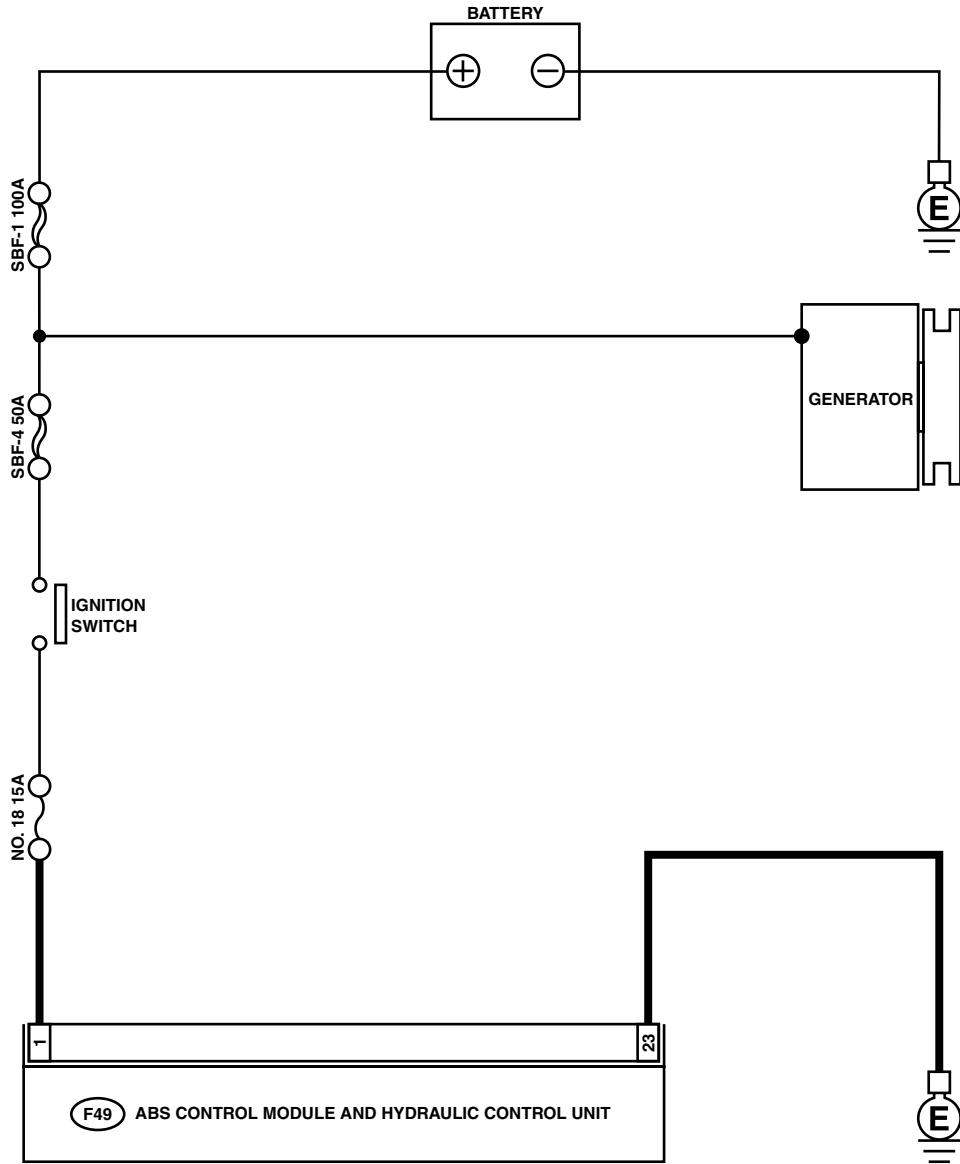

F49

1	2	3	4	5	6	7	8	9	10	11	12	13	14	15
16	17	18	19	20	21	22		23	24	25	26			
27	28	29	30	31										

ABS00294

DIAGNOSTICS CHART WITH SUBARU SELECT MONITOR

ABS (DIAGNOSTICS)

Step	Check	Yes	No
1 CHECK GENERATOR. 1) Start engine. 2) Idling after warm-up. 3) Measure voltage between generator B terminal and chassis ground. <i>Terminal</i> <i>Generator B terminal — Chassis ground:</i>	Is the measured value within 10 to 17 V?	Go to step 2.	i) Repair generator. ii) H4 engine model: iii) <Ref. to SC(H4SO)-15, Generator.> iv) H6 engine model: v) <Ref. to SC(H6DO)-14, Generator.>
2 CHECK BATTERY TERMINAL. Turn ignition switch to OFF.	Are the positive and negative battery terminals tightly clamped?	Go to step 3.	Tighten the clamp of terminal.
3 CHECK INPUT VOLTAGE OF ABSCM&H/U. 1) Disconnect connector from ABSCM&H/U. 2) Run the engine at idle. 3) Measure voltage between ABSCM&H/U connector and chassis ground. <i>Connector & terminal</i> <i>(F49) No. 1 (+) — Chassis ground (-):</i>	Is the measured value within 10 to 17 V?	Go to step 4.	Repair harness connector between battery, ignition switch and ABSCM&H/U.
4 CHECK GROUND CIRCUIT OF ABSCM&H/U. 1) Turn ignition switch to OFF. 2) Measure resistance between ABSCM&H/U connector and chassis ground. <i>Connector & terminal</i> <i>(F49) No. 23 — Chassis ground:</i>	Is the measured value less than 0.5 Ω ?	Go to step 5.	Repair ABSCM&H/U ground harness.
5 CHECK POOR CONTACT IN CONNECTORS.	Is there poor contact in connectors between generator, battery and ABSCM&H/U?	Repair connector.	Go to step 6.
6 CHECK ABSCM&H/U. 1) Connect all connectors. 2) Erase the memory. 3) Perform inspection mode. 4) Read out the DTC.	Is the same DTC still being output?	Replace ABSCM&H/U. <Ref. to ABS-6, ABS Control Module and Hydraulic Control Unit (ABSCM&H/U).>	Go to step 7.
7 CHECK ANY OTHER DTC APPEARANCE.	Are other DTC being output?	Proceed with the diagnosis corresponding to the DTC.	A temporary poor contact.

DIAGNOSTICS CHART WITH SUBARU SELECT MONITOR

ABS (DIAGNOSTICS)

W: DTC 44 ABS-AT CONTROL (NON CONTROLLED)

DIAGNOSIS:

- Combination of AT control faults

TROUBLE SYMPTOM:

- ABS does not operate.

WIRING DIAGRAM:

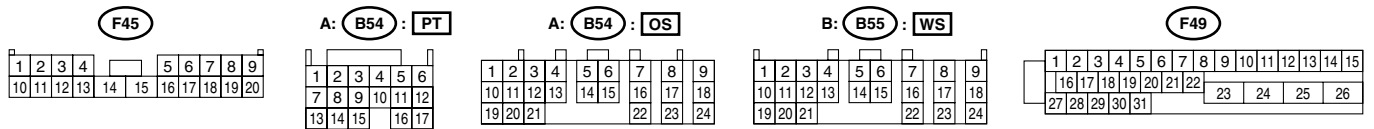
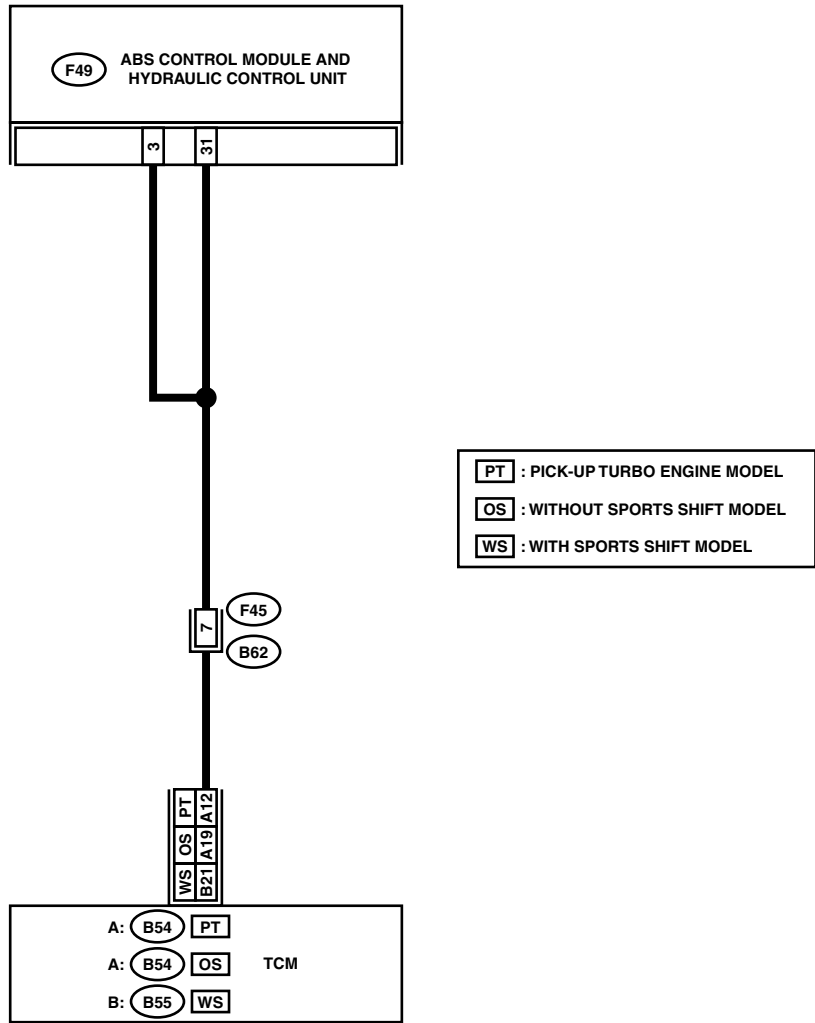

ABS00426

DIAGNOSTICS CHART WITH SUBARU SELECT MONITOR

ABS (DIAGNOSTICS)

Step	Check	Yes	No
1 CHECK SPECIFICATIONS OF THE ABSCM&H/U. Check specifications of the mark to the ABSCM&H/U. <i>CG: AT (except OUTBACK,BAJA)</i> <i>CH: MT (except OUTBACK,BAJA)</i> <i>CI: AT (OUTBACK,BAJA)</i> <i>CJ: MT (OUTBACK,BAJA)</i>	Do the vehicle specification and the specification of ABSCM&HU match?	Go to step 2.	Replace ABSCM&H/U. <Ref. to ABS-6, ABS Control Module and Hydraulic Control Unit (ABSCM&H/U).>
2 CHECK GROUND SHORT OF HARNESS. 1) Turn ignition switch to OFF. 2) Disconnect two connectors from TCM. 3) Disconnect connector from ABSCM&H/U. 4) Measure resistance between ABSCM&H/U connector and chassis ground. <i>Connector & terminal</i> <i>(F49) No. 3 — Chassis ground:</i>	Is the measured value more than 1 MΩ?	Go to step 3.	Repair harness between TCM and ABSCM&H/U.
3 CHECK TCM. 1) Connect all connectors to TCM. 2) Turn ignition switch to ON. 3) Measure voltage between TCM connector terminal and chassis ground. <i>Connector & terminal</i> <i>PT: (B54) No. 12 (+) — Chassis ground (-):</i> <i>OS: (B54) No. 19 (+) — Chassis ground (-):</i> <i>WS: (B55) No. 21 (+) — Chassis ground (-):</i>	Is the measured value within 10 to 15 V?	Go to step 5.	Go to step 4.
4 CHECK AT.	Is the AT functioning normally?	Replace TCM.	Repair AT.
5 CHECK OPEN CIRCUIT OF HARNESS. Measure voltage between ABSCM&H/U connector and chassis ground. <i>Connector & terminal</i> <i>(F49) No. 3 (+) — Chassis ground (-):</i> <i>(F49) No. 31 (+) — Chassis ground (-):</i>	Is the measured value within 10 to 15 V?	Go to step 6.	Repair harness/connector between TCM and ABSCM&H/U.
6 CHECK POOR CONTACT IN CONNECTORS.	Is there poor contact in connectors between TCM and ABSCM&H/U?	Repair connector.	Go to step 7.
7 CHECK ABSCM&H/U. 1) Connect all connectors. 2) Erase the memory. 3) Perform inspection mode. 4) Read out the DTC.	Is the same DTC still being output?	Replace ABSCM&H/U. <Ref. to ABS-6, ABS Control Module and Hydraulic Control Unit (ABSCM&H/U).>	Go to step 8.
8 CHECK ANY OTHER DTC APPEARANCE.	Are other DTC being output?	Proceed with the diagnosis corresponding to the DTC.	A temporary poor contact.

DIAGNOSTICS CHART WITH SUBARU SELECT MONITOR

ABS (DIAGNOSTICS)

X: DTC 44 ABS-AT CONTROL (CONTROLLED)

DIAGNOSIS:

- Combination of AT control faults

TROUBLE SYMPTOM:

- ABS does not operate.

WIRING DIAGRAM:

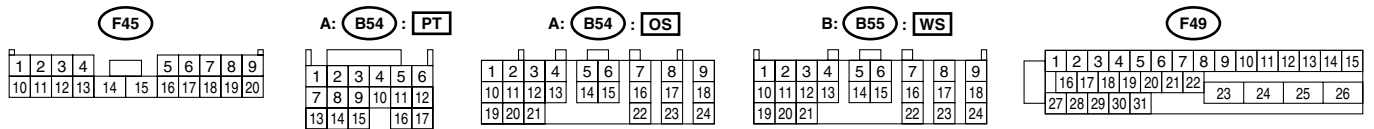
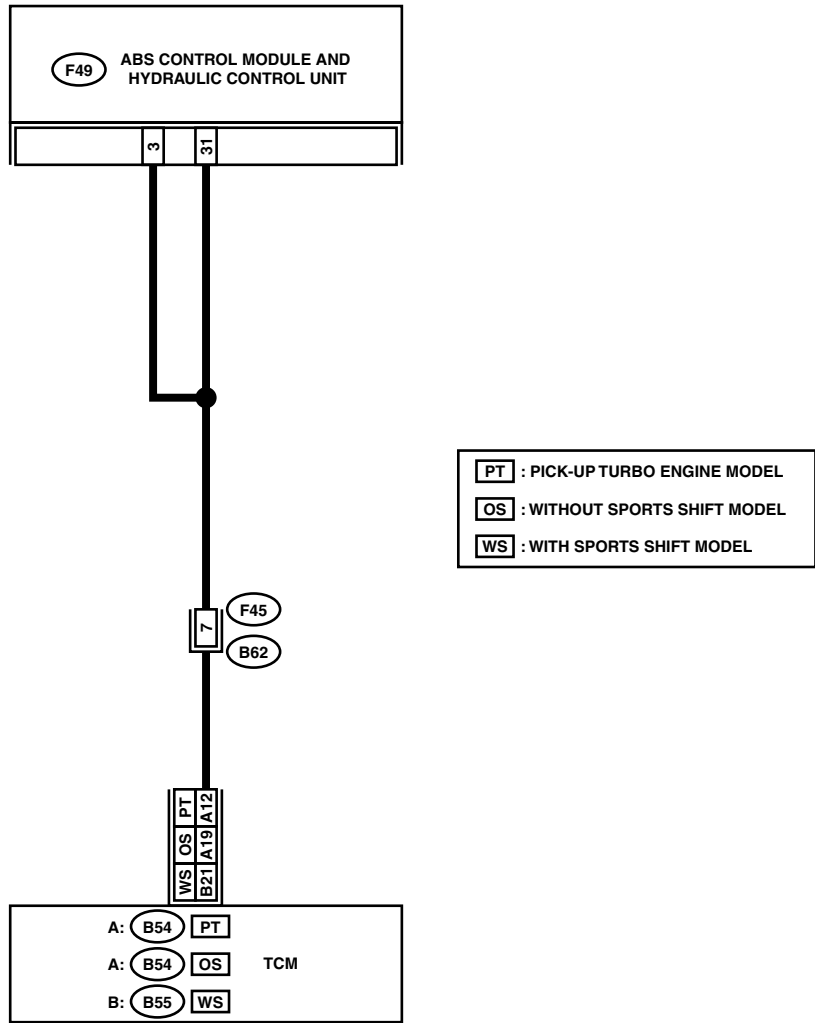

ABS00426

DIAGNOSTICS CHART WITH SUBARU SELECT MONITOR

ABS (DIAGNOSTICS)

Step	Check	Yes	No
1 CHECK BATTERY SHORT OF HARNESS. 1) Turn ignition switch to OFF. 2) Disconnect two connectors from TCM. 3) Disconnect connector from ABSCM&H/U. 4) Measure voltage between ABSCM&H/U connector and chassis ground. Connector & terminal (F49) No. 3 (+) — Chassis ground (-):	Is the measured value less than 1 V?	Go to step 2.	Repair harness between TCM and ABSCM&H/U.
2 CHECK BATTERY SHORT OF HARNESS. 1) Turn ignition switch to ON. 2) Measure voltage between ABSCM&H/U connector and chassis ground. Connector & terminal (F49) No. 3 (+) — Chassis ground (-):	Is the measured value less than 1 V?	Go to step 3.	Repair harness between TCM and ABSCM&H/U.
3 CHECK OPEN CIRCUIT OF HARNESS. 1) Turn ignition switch to OFF. 2) Connect all connectors to TCM. 3) Turn ignition switch to ON. 4) Measure voltage between ABSCM&H/U connector and chassis ground. Connector & terminal (F49) No. 3 (+) — Chassis ground (-): (F49) No. 31 (+) — Chassis ground (-):	Is the measured value within 10 to 13 V?	Go to step 4.	Repair harness/connector between TCM and ABSCM&H/U.
4 CHECK POOR CONTACT IN CONNECTORS. Turn ignition switch to OFF. Is there poor contact in connectors between TCM and ABSCM&H/U?	There is no poor contact.	Go to step 5.	Repair connector.
5 CHECK ABSCM&H/U. 1) Connect all connectors. 2) Erase the memory. 3) Perform inspection mode. 4) Read out the DTC.	Is the same DTC still being output?	Replace ABSCM&H/U. <Ref. to ABS-6, ABS Control Module and Hydraulic Control Unit (ABSCM&H/U).>	Go to step 6.
6 CHECK ANY OTHER DTC APPEARANCE.	Are other DTC being output?	Proceed with the diagnosis corresponding to the DTC.	A temporary poor contact.

DIAGNOSTICS CHART WITH SUBARU SELECT MONITOR

ABS (DIAGNOSTICS)

Y: DTC 51 VALVE RELAY MALFUNCTION

DIAGNOSIS:

- Faulty valve relay

TROUBLE SYMPTOM:

- ABS does not operate.

WIRING DIAGRAM:

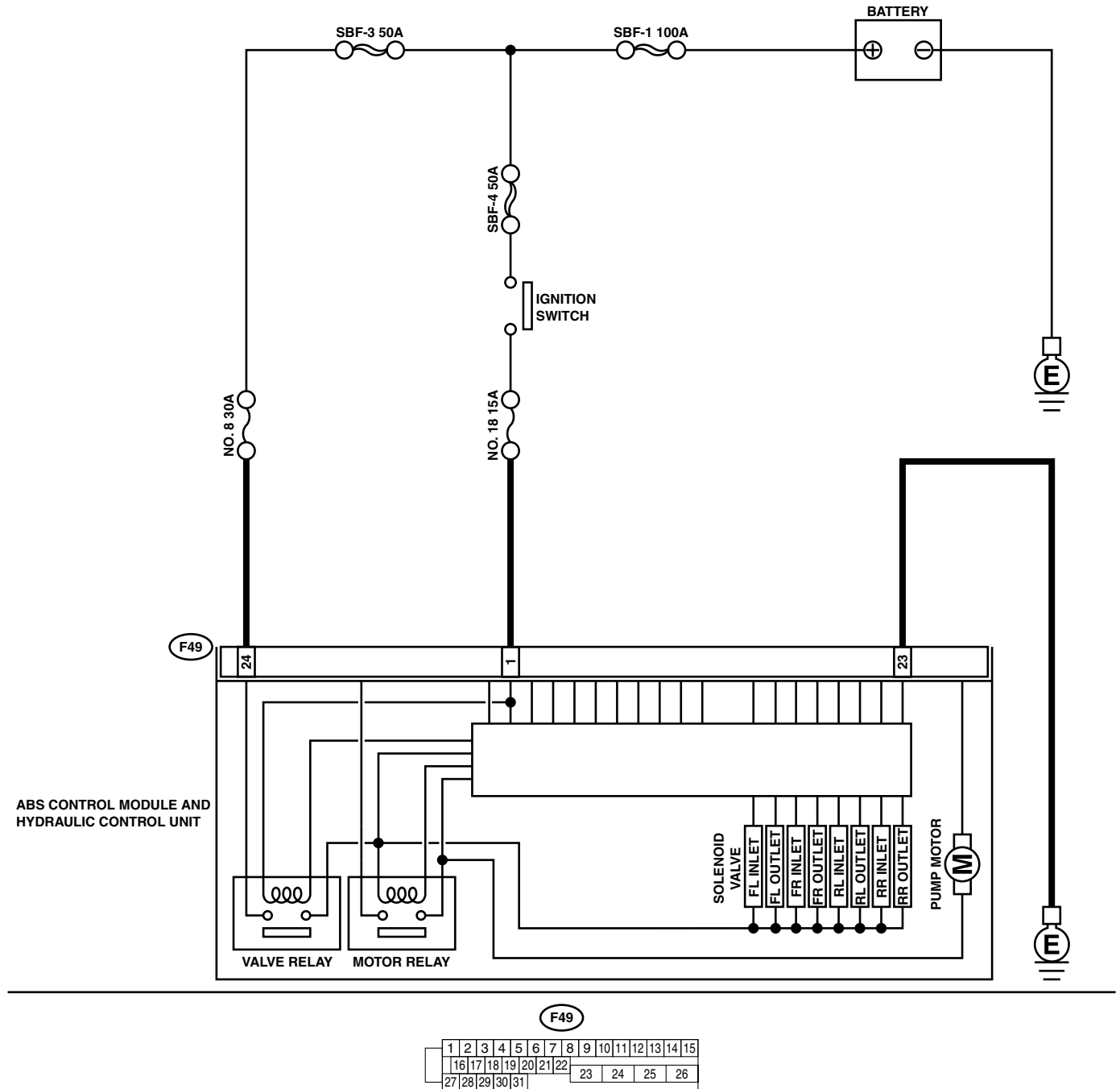

ABS00297

DIAGNOSTICS CHART WITH SUBARU SELECT MONITOR

ABS (DIAGNOSTICS)

Step	Check	Yes	No
1 CHECK INPUT VOLTAGE OF ABSCM&H/U. 1) Turn ignition switch to OFF. 2) Disconnect connector from ABSCM&H/U. 3) Run the engine at idle. 4) Measure voltage between ABSCM&H/U connector and chassis ground. Connector & terminal (F49) No. 1 (+) — Chassis ground (-): (F49) No. 24 (+) — Chassis ground (-):	Is the measured value within 10 to 15 V?	Go to step 2.	Repair harness connector between battery and ABSCM&H/U.
2 CHECK GROUND CIRCUIT OF ABSCM&H/U. 1) Turn ignition switch to OFF. 2) Measure resistance between ABSCM&H/U connector and chassis ground. Connector & terminal (F49) No. 23 — Chassis ground:	Is the measured value less than 0.5 Ω?	Go to step 3.	Repair ABSCM&H/U ground harness.
3 CHECK POOR CONTACT IN CONNECTORS.	Is there poor contact in connectors between generator, battery and ABSCM&H/U?	Repair connector.	Go to step 4.
4 CHECK ABSCM&H/U. 1) Connect all connectors. 2) Erase the memory. 3) Perform inspection mode. 4) Read out the DTC.	Is the same DTC still being output?	Replace ABSCM&H/U. <Ref. to ABS-6, ABS Control Module and Hydraulic Control Unit (ABSCM&H/U).>	Go to step 5.
5 CHECK ANY OTHER DTC APPEARANCE.	Are other DTC being output?	Proceed with the diagnosis corresponding to the DTC.	A temporary poor contact.

DIAGNOSTICS CHART WITH SUBARU SELECT MONITOR

ABS (DIAGNOSTICS)

Z: DTC 51 VALVE RELAY ON FAILURE

DIAGNOSIS:

- Faulty valve relay

TROUBLE SYMPTOM:

- ABS does not operate.

WIRING DIAGRAM:

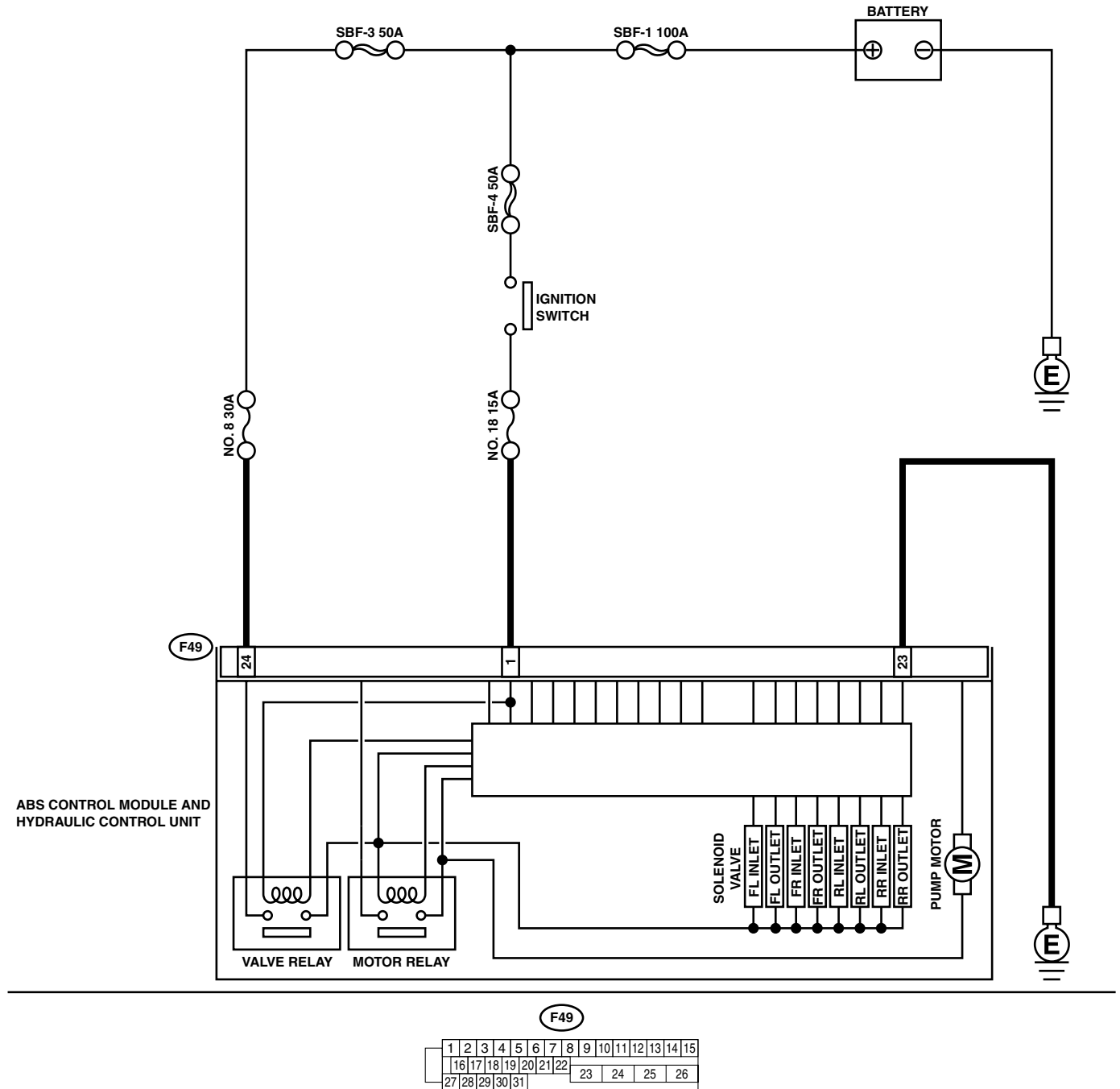

ABS00297

DIAGNOSTICS CHART WITH SUBARU SELECT MONITOR

ABS (DIAGNOSTICS)

Step	Check	Yes	No
1 CHECK VALVE RELAY IN ABSCM&H/U. Measure resistance between ABSCM&H/U terminals. <i>Terminals</i> <i>No. 23 (+) — No. 24 (-):</i>	Is the measured value more than 1 MΩ?	Go to step 2.	Replace ABSCM&H/U. <Ref. to ABS-6, ABS Control Module and Hydraulic Control Unit (ABSCM&H/U).>
2 CHECK POOR CONTACT IN CONNECTORS.	Is there poor contact in connectors between generator, battery and ABSCM&H/U?	Repair connector.	Go to step 3.
3 CHECK ABSCM&H/U. 1) Connect all connectors. 2) Erase the memory. 3) Perform inspection mode. 4) Read out the DTC.	Is the same DTC still being output?	Replace ABSCM&H/U. <Ref. to ABS-6, ABS Control Module and Hydraulic Control Unit (ABSCM&H/U).>	Go to step 4.
4 CHECK ANY OTHER DTC APPEARANCE.	Are other DTC being output?	Proceed with the diagnosis corresponding to the DTC.	A temporary poor contact.

DIAGNOSTICS CHART WITH SUBARU SELECT MONITOR

ABS (DIAGNOSTICS)

AA:DTC 52 OPEN CIRCUIT IN MOTOR RELAY CIRCUIT

DIAGNOSIS:

- Faulty motor
- Faulty motor relay
- Faulty harness connector

TROUBLE SYMPTOM:

- ABS does not operate.

WIRING DIAGRAM:

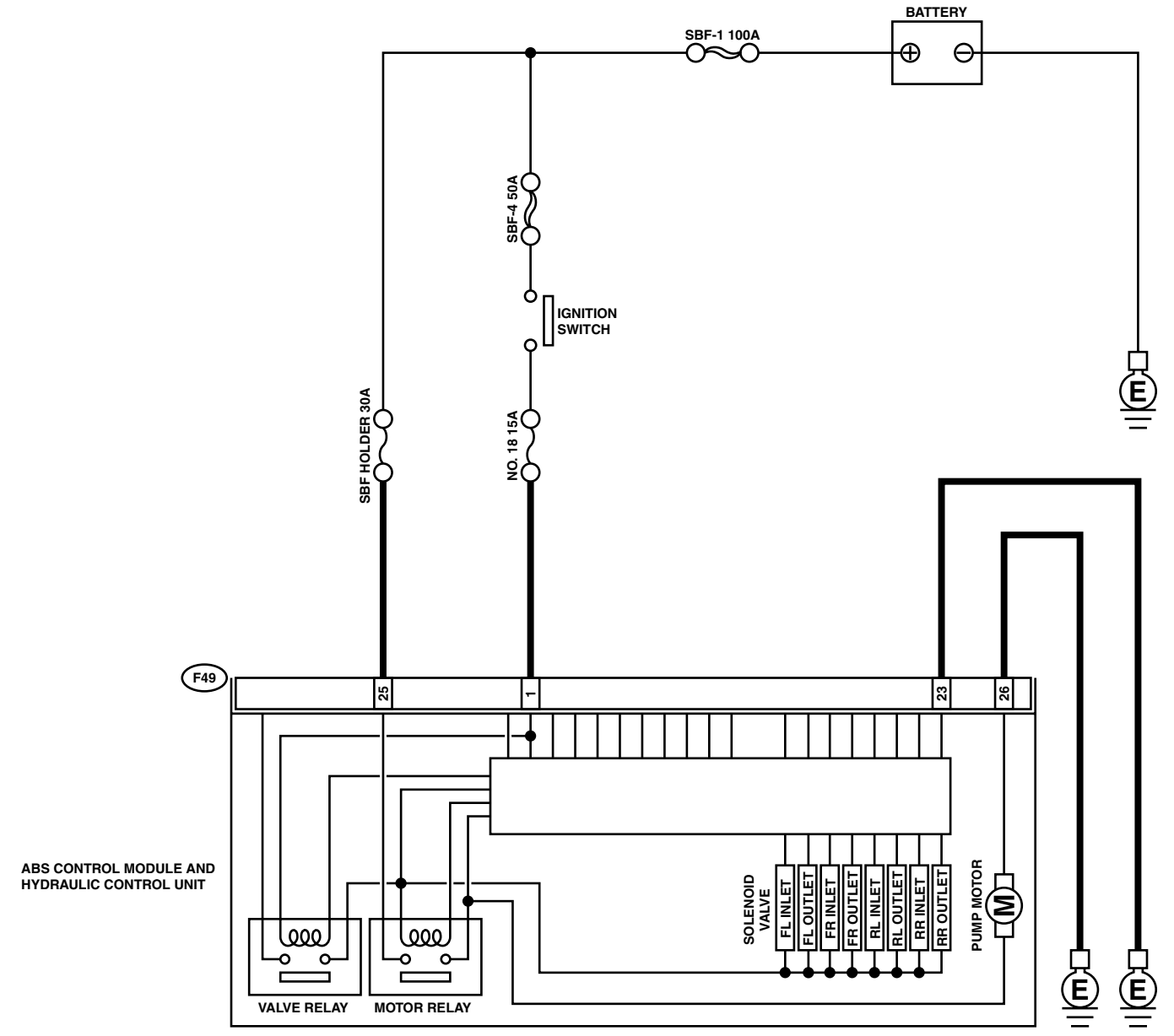

F49

1	2	3	4	5	6	7	8	9	10	11	12	13	14	15
16	17	18	19	20	21	22	23	24	25	26				
27	28	29	30	31										

ABS00427

DIAGNOSTICS CHART WITH SUBARU SELECT MONITOR

ABS (DIAGNOSTICS)

Step	Check	Yes	No
1 CHECK INPUT VOLTAGE OF ABSCM&H/U. 1) Turn ignition switch to OFF. 2) Disconnect connector from ABSCM&H/U. 3) Turn ignition switch to ON. 4) Measure voltage between ABSCM&H/U connector and chassis ground. Connector & terminal (F49) No. 25 (+) — Chassis ground (-):	Is the measured value within 10 to 15 V?	Go to step 2.	Repair harness/connector between battery and ABSCM&H/U and check fuse SBF7.
2 CHECK GROUND CIRCUIT OF MOTOR. 1) Turn ignition switch to OFF. 2) Measure resistance between ABSCM&H/U connector and chassis ground. Connector & terminal (F49) No. 26 — Chassis ground:	Is the measured value less than 0.5 Ω?	Go to step 3.	Repair ABSCM&H/U ground harness.
3 CHECK MOTOR OPERATION. Operate the sequence control. <Ref. to ABS-9, ABS Sequence Control.> NOTE: Use the diagnosis connector to operate the sequence control.	Can motor revolution noise (buzz) be heard when carrying out the sequence?	Go to step 4.	Replace ABSCM&H/U. <Ref. to ABS-6, ABS Control Module and Hydraulic Control Unit (ABSCM&H/U).>
4 CHECK POOR CONTACT IN CONNECTORS. Turn ignition switch to OFF.	Is there poor contact in connector between generator, battery and ABSCM&H/U?	Repair connector.	Go to step 5.
5 CHECK ABSCM&H/U. 1) Connect all connectors. 2) Erase the memory. 3) Perform inspection mode. 4) Read out the DTC.	Is the same DTC still being output?	Replace ABSCM&H/U. <Ref. to ABS-6, ABS Control Module and Hydraulic Control Unit (ABSCM&H/U).>	Go to step 6.
6 CHECK ANY OTHER DTC APPEARANCE.	Are other DTC being output?	Proceed with the diagnosis corresponding to the DTC.	A temporary poor contact.

DIAGNOSTICS CHART WITH SUBARU SELECT MONITOR

ABS (DIAGNOSTICS)

AB:DTC 52 MOTOR RELAY ON FAILURE

DIAGNOSIS:

- Faulty motor
- Faulty motor relay
- Faulty harness connector

TROUBLE SYMPTOM:

- ABS does not operate.

WIRING DIAGRAM:

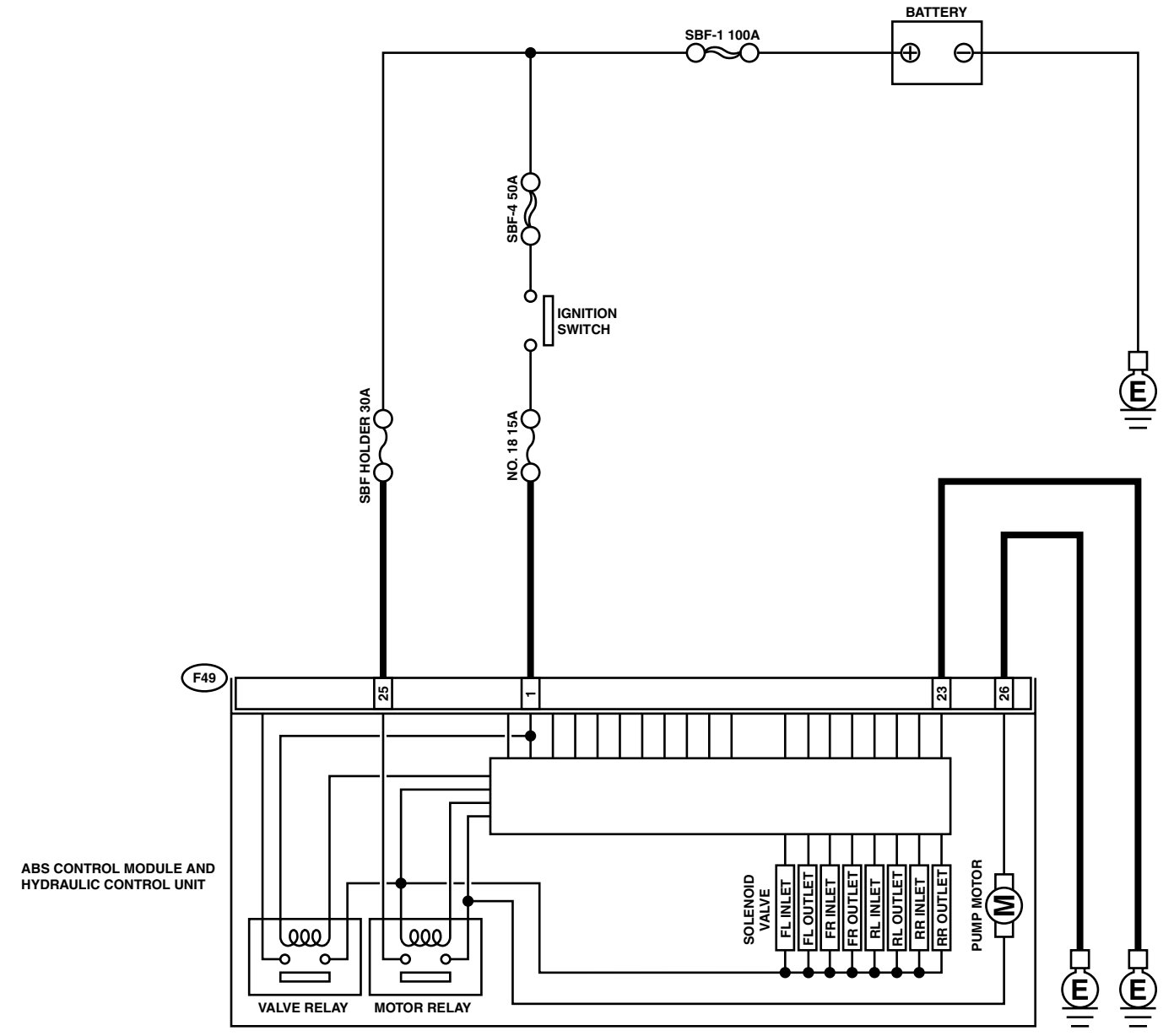

F49

1	2	3	4	5	6	7	8	9	10	11	12	13	14	15
16	17	18	19	20	21	22	23	24	25	26				
27	28	29	30	31										

ABS00427

DIAGNOSTICS CHART WITH SUBARU SELECT MONITOR

ABS (DIAGNOSTICS)

Step	Check	Yes	No
1 CHECK MOTOR RELAY IN ABSCM&H/U. Measure resistance between ABSCM&H/U terminals. <i>Terminals</i> <i>No. 25 — No. 26:</i>	Is the measured value more than 1 MΩ?	Go to step 2.	Replace ABSCM&H/U. <Ref. to ABS-6, ABS Control Module and Hydraulic Control Unit (ABSCM&H/U).>
2 CHECK MOTOR OPERATION. Operate the sequence control. <Ref. to ABS-9, ABS Sequence Control.> NOTE: Use the diagnosis connector to operate the sequence control.	Can motor revolution noise (buzz) be heard when carrying out the sequence control?	Go to step 3.	Replace ABSCM&H/U. <Ref. to ABS-6, ABS Control Module and Hydraulic Control Unit (ABSCM&H/U).>
3 CHECK POOR CONTACT IN CONNECTORS. Turn ignition switch to OFF.	Is there poor contact in connector between generator, battery and ABSCM&H/U?	Repair connector.	Go to step 4.
4 CHECK ABSCM&H/U. 1) Connect all connectors. 2) Erase the memory. 3) Perform inspection mode. 4) Read out the DTC.	Is the same DTC still being output?	Replace ABSCM&H/U. <Ref. to ABS-6, ABS Control Module and Hydraulic Control Unit (ABSCM&H/U).>	Go to step 5.
5 CHECK ANY OTHER DTC APPEARANCE.	Are other DTC being output?	Proceed with the diagnosis corresponding to the DTC.	A temporary poor contact.

DIAGNOSTICS CHART WITH SUBARU SELECT MONITOR

ABS (DIAGNOSTICS)

AC:DTC 52 MOTOR MALFUNCTION

DIAGNOSIS:

- Faulty motor
- Faulty motor relay
- Faulty harness connector

TROUBLE SYMPTOM:

- ABS does not operate.

WIRING DIAGRAM:

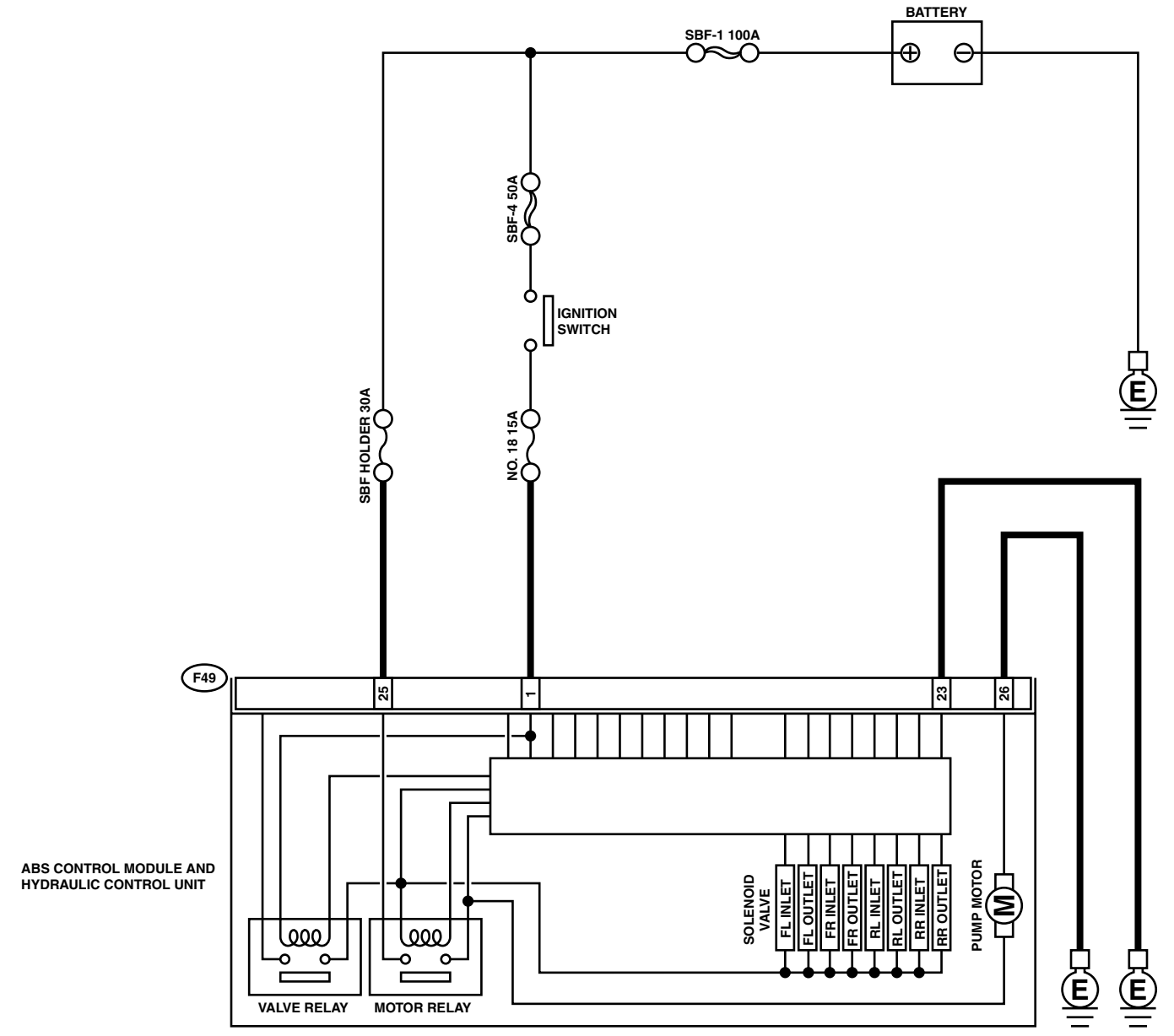

F49

1	2	3	4	5	6	7	8	9	10	11	12	13	14	15
16	17	18	19	20	21	22	23	24	25	26				
27	28	29	30	31										

DIAGNOSTICS CHART WITH SUBARU SELECT MONITOR

ABS (DIAGNOSTICS)

Step	Check	Yes	No
1 CHECK INPUT VOLTAGE OF ABSCM&H/U. 1) Turn ignition switch to OFF. 2) Disconnect connector from ABSCM&H/U. 3) Turn ignition switch to ON. 4) Measure voltage between ABSCM&H/U connector and chassis ground. Connector & terminal (F49) No. 25 (+) — Chassis ground (-):	Is the measured value within 10 to 13 V?	Go to step 2.	Repair harness/connector between battery and ABSCM&H/U and check fuse SBF7.
2 CHECK GROUND CIRCUIT OF MOTOR. 1) Turn ignition switch to OFF. 2) Measure resistance between ABSCM&H/U connector and chassis ground. Connector & terminal (F49) No. 26 — Chassis ground:	Is the measured value less than 0.5 Ω?	Go to step 3.	Repair ABSCM&H/U ground harness.
3 CHECK INPUT VOLTAGE OF ABSCM&H/U. 1) Run the engine at idle. 2) Measure voltage between ABSCM&H/U connector and chassis ground. Connector & terminal (F49) No. 1 (+) — Chassis ground (-):	Is the measured value within 10 to 15 V?	Go to step 4.	Repair harness connector between battery, ignition switch and ABSCM&H/U.
4 CHECK GROUND CIRCUIT OF ABSCM&H/U. 1) Turn ignition switch to OFF. 2) Measure resistance between ABSCM&H/U connector and chassis ground. Connector & terminal (F49) No. 23 — Chassis ground:	Is the measured value less than 0.5 Ω?	Go to step 5.	Repair ABSCM&H/U ground harness.
5 CHECK MOTOR OPERATION. Operate the sequence control. <Ref. to ABS-9, ABS Sequence Control.> NOTE: Use the diagnosis connector to operate the sequence control.	Can motor revolution noise (buzz) be heard when carrying out the sequence control?	Go to step 6.	Replace ABSCM&H/U. <Ref. to ABS-6, ABS Control Module and Hydraulic Control Unit (ABSCM&H/U).>
6 CHECK POOR CONTACT IN CONNECTORS. Turn ignition switch to OFF.	Is there poor contact in connector between generator, battery and ABSCM&H/U?	Repair connector.	Go to step 7.
7 CHECK ABSCM&H/U. 1) Connect all connectors. 2) Erase the memory. 3) Perform inspection mode. 4) Read out the DTC.	Is the same DTC still being output?	Replace ABSCM&H/U. <Ref. to ABS-6, ABS Control Module and Hydraulic Control Unit (ABSCM&H/U).>	Go to step 8.
8 CHECK ANY OTHER DTC APPEARANCE.	Are other DTC being output?	Proceed with the diagnosis corresponding to the DTC.	A temporary poor contact.

DIAGNOSTICS CHART WITH SUBARU SELECT MONITOR

ABS (DIAGNOSTICS)

AD:DTC 54 STOP LIGHT SWITCH SIGNAL CIRCUIT MALFUNCTION

DIAGNOSIS:

- Faulty stop light switch

TROUBLE SYMPTOM:

- ABS does not operate.

WIRING DIAGRAM:

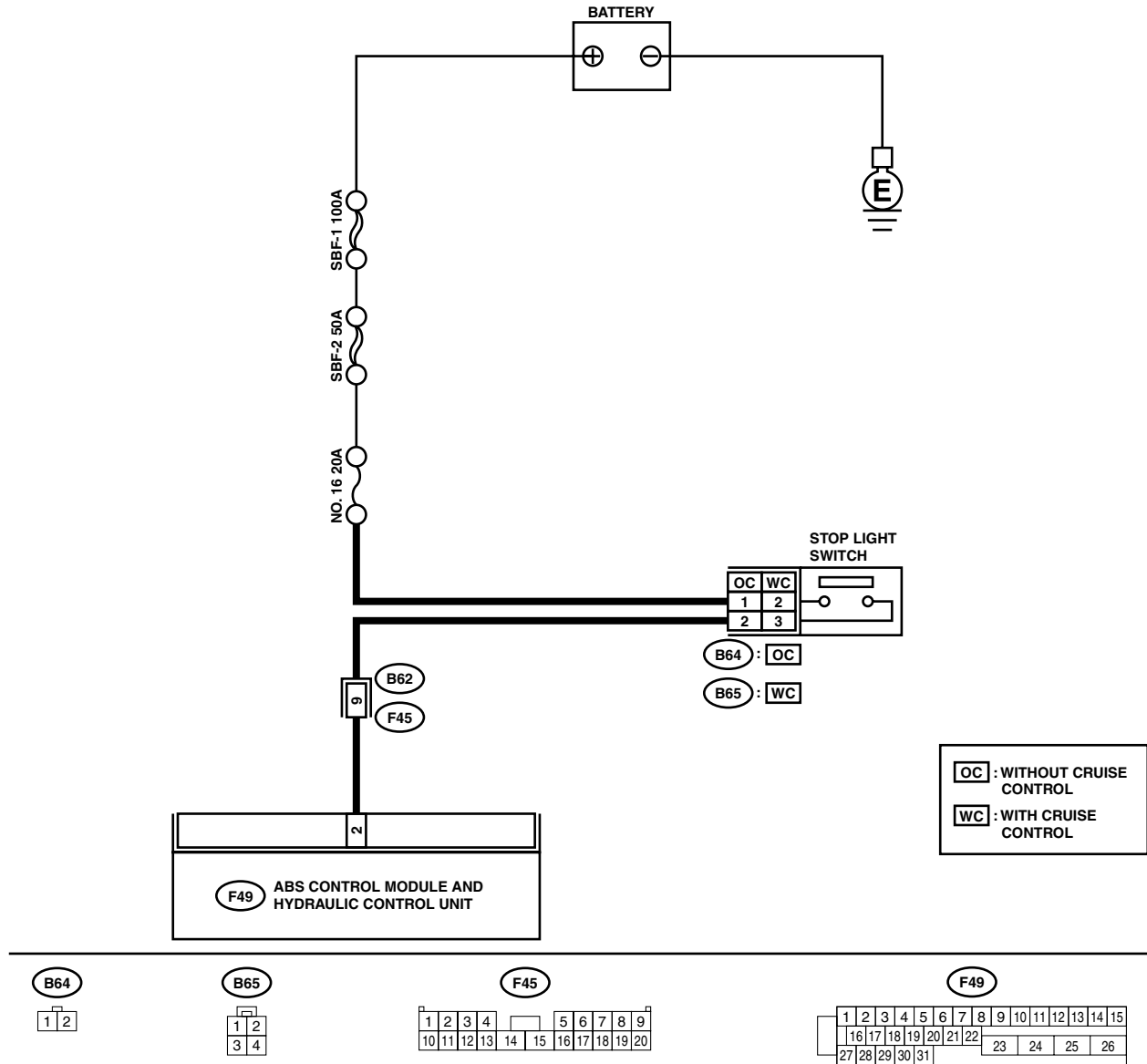

ABS00428

DIAGNOSTICS CHART WITH SUBARU SELECT MONITOR

ABS (DIAGNOSTICS)

Step	Check	Yes	No
1 CHECK OUTPUT OF STOP LIGHT SWITCH USING SELECT MONITOR. 1) Select "Current data display & Save" on the select monitor. 2) Release the brake pedal. 3) Read the stop light switch output in the select monitor data display.	Is the reading indicated on monitor display less than 1.5 V?	Go to step 2.	Go to step 3.
2 CHECK OUTPUT OF STOP LIGHT SWITCH USING SELECT MONITOR. 1) Depress the brake pedal. 2) Read the stop light switch output in the select monitor data display.	Is the reading indicated on monitor display within 10 to 15 V?	Go to step 5.	Go to step 3.
3 CHECK IF STOP LIGHTS COME ON. Depress the brake pedal.	Do stop lights turn on?	Go to step 4.	Repair stop lights circuit.
4 CHECK OPEN CIRCUIT IN HARNESS. 1) Turn ignition switch to OFF. 2) Disconnect connector from ABSCM&H/U. 3) Depress brake pedal. 4) Measure voltage between ABSCM&H/U connector and chassis ground. <i>Connector & terminal (F49) No. 2 — Chassis ground:</i>	Is the measured value within 10 to 15 V?	Go to step 5.	Repair harness between stop light switch and ABSCM&H/U connector.
5 CHECK POOR CONTACT IN CONNECTORS.	Is there poor contact in connector between stop light switch and ABSCM&H/U?	Repair connector.	Go to step 6.
6 CHECK ABSCM&H/U. 1) Connect all connectors. 2) Erase the memory. 3) Perform inspection mode. 4) Read out the DTC.	Is the same DTC still being output?	Replace ABSCM&H/U. <Ref. to ABS-6, ABS Control Module and Hydraulic Control Unit (ABSCM&H/U).>	Go to step 7.
7 CHECK ANY OTHER DTC APPEARANCE.	Are other DTC being output?	Proceed with the diagnosis corresponding to the DTC.	A temporary poor contact.

DIAGNOSTICS CHART WITH SUBARU SELECT MONITOR

ABS (DIAGNOSTICS)

AE:DTC 56 OPEN OR SHORT CIRCUIT IN G SENSOR CIRCUIT

DIAGNOSIS:

- Faulty G sensor output voltage

TROUBLE SYMPTOM:

- ABS does not operate.

WIRING DIAGRAM:

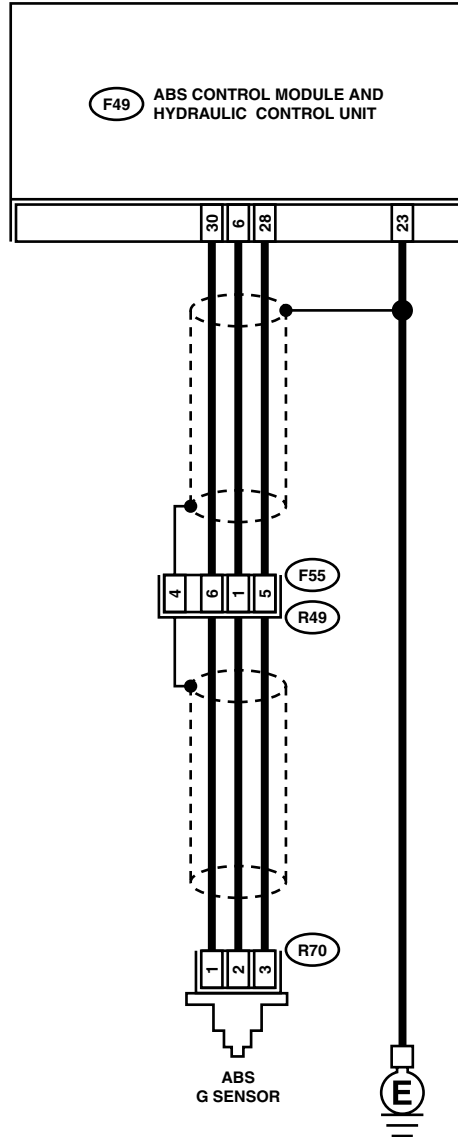

R70

1 2 3

F55

1 2 3 4 5
6 7 8 9 10 11 12

F49

1 2 3 4 5 6 7 8 9 10 11 12 13 14 15
16 17 18 19 20 21 22 23 24 25 26
27 28 29 30 31

ABS00429

DIAGNOSTICS CHART WITH SUBARU SELECT MONITOR

ABS (DIAGNOSTICS)

Step	Check	Yes	No
1 CHECK OUTPUT OF G SENSOR USING SELECT MONITOR. 1) Select "Current data display & Save" on the select monitor. 2) Read the G sensor output in select monitor data display.	Is the G sensor output on the monitor display within 2.1 to 2.5 V when the G sensor is in horizontal position?	Go to step 2.	Go to step 5.
2 CHECK POOR CONTACT IN CONNECTORS.	Is there poor contact in connector between ABSCM&H/U and G sensor?	Repair connector.	Go to step 3.
3 CHECK ABSCM&H/U. 1) Connect all connectors. 2) Erase the memory. 3) Perform inspection mode. 4) Read out the DTC.	Is the same DTC still being output?	Replace ABSCM&H/U. <Ref. to ABS-6, ABS Control Module and Hydraulic Control Unit (ABSCM&H/U).>	Go to step 4.
4 CHECK ANY OTHER DTC APPEARANCE.	Are other DTC being output?	Proceed with the diagnosis corresponding to the DTC.	A temporary poor contact.
5 CHECK INPUT VOLTAGE OF G SENSOR. 1) Turn ignition switch to OFF. 2) Remove console box. 3) Disconnect G sensor from body. (Do not disconnect connector.) 4) Turn ignition switch to ON. 5) Measure voltage between G sensor connector terminals. <i>Connector & terminal (R70) No. 1 (+) — No. 3 (-):</i>	Is the measured value within 4.75 to 5.25 V?	Go to step 6.	Repair harness/connector between G sensor and ABSCM&H/U.
6 CHECK OPEN CIRCUIT IN G SENSOR OUTPUT HARNESS AND GROUND HARNESS. 1) Turn ignition switch to OFF. 2) Disconnect connector from ABSCM&H/U. 3) Measure resistance between ABSCM&H/U connector terminals. <i>Connector & terminal (F49) No. 6 — No. 28:</i>	Is the measured value within 5.0 to 5.6 kΩ?	Go to step 7.	Repair harness/connector between G sensor and ABSCM&H/U.
7 CHECK GROUND SHORT IN G SENSOR OUTPUT HARNESS. 1) Disconnect connector from G sensor. 2) Measure resistance between ABSCM&H/U connector and chassis ground. <i>Connector & terminal (F49) No. 6 — Chassis ground:</i>	Is the measured value more than 1 MΩ?	Go to step 8.	Repair harness between G sensor and ABSCM&H/U.
8 CHECK G SENSOR. 1) Connect connector to G sensor. 2) Connect connector to ABSCM&H/U. 3) Turn ignition switch to ON. 4) Measure voltage between G sensor connector terminals. <i>Connector & terminal (R70) No. 2 (+) — No. 3 (-):</i>	Is the measured value within 2.1 to 2.5 V when G sensor is horizontal?	Go to step 9.	Replace G sensor. <Ref. to ABS-21, G Sensor.>
9 CHECK G SENSOR. Measure voltage between G sensor connector terminals. <i>Connector & terminal (R70) No. 2 (+) — No. 3 (-):</i>	Is the measured value within 3.7 to 4.1 V when G sensor is inclined forwards to 90°?	Go to step 10.	Replace G sensor. <Ref. to ABS-21, G Sensor.>

DIAGNOSTICS CHART WITH SUBARU SELECT MONITOR

ABS (DIAGNOSTICS)

Step	Check	Yes	No
10 CHECK G SENSOR. Measure voltage between G sensor connector terminals. <i>Connector & terminal</i> <i>(R70) No. 2 (+) — No. 3 (-):</i>	Is the measured value within 0.5 to 0.9 V when G sensor is inclined backwards to 90°?	Go to step 11.	Replace G sensor. <Ref. to ABS-21, G SENSOR, .>
11 CHECK POOR CONTACT IN CONNECTORS. Turn ignition switch to OFF.	Is there poor contact in connector between ABSCM&H/U and G sensor?	Repair connector.	Go to step 12.
12 CHECK ABSCM&H/U. 1) Connect all connectors. 2) Erase the memory. 3) Perform inspection mode. 4) Read out the DTC.	Is the same DTC still being output?	Replace ABSCM&H/U. <Ref. to ABS-6, ABS Control Module and Hydraulic Control Unit (ABSCM&H/U).>	Go to step 13.
13 CHECK ANY OTHER DTC APPEARANCE.	Are other DTC being output?	Proceed with the diagnosis corresponding to the DTC.	A temporary poor contact.

DIAGNOSTICS CHART WITH SUBARU SELECT MONITOR

ABS (DIAGNOSTICS)

MEMO:

DIAGNOSTICS CHART WITH SUBARU SELECT MONITOR

ABS (DIAGNOSTICS)

AF:DTC 56 BATTERY SHORT IN G SENSOR CIRCUIT

DIAGNOSIS:

- Faulty G sensor output voltage

TROUBLE SYMPTOM:

- ABS does not operate.

WIRING DIAGRAM:

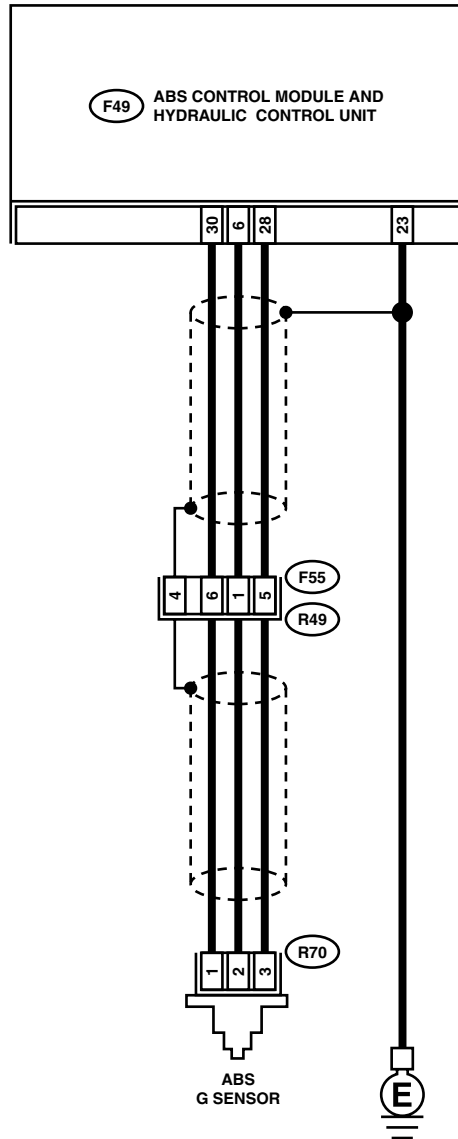

R70

1	2	3
---	---	---

F55

1	2	3	4	5		
6	7	8	9	10	11	12

F49

1	2	3	4	5	6	7	8	9	10	11	12	13	14	15
16	17	18	19	20	21	22	23	24	25	26				
27	28	29	30	31										

DIAGNOSTICS CHART WITH SUBARU SELECT MONITOR

ABS (DIAGNOSTICS)

Step	Check	Yes	No
1 CHECK OUTPUT OF G SENSOR USING SELECT MONITOR. 1) Select "Current data display & Save" on the select monitor. 2) Read the G sensor output in select monitor data display.	Is the G sensor output on the monitor display between within 2.1 to 2.5 V when the G sensor is in horizontal position?	Go to step 2.	Go to step 5.
2 CHECK POOR CONTACT IN CONNECTORS.	Is there poor contact in connector between ABSCM&H/U and G sensor?	Repair connector.	Go to step 3.
3 CHECK ABSCM&H/U. 1) Connect all connectors. 2) Erase the memory. 3) Perform inspection mode. 4) Read out the DTC.	Is the same DTC still being output?	Replace ABSCM&H/U. <Ref. to ABS-6, ABS Control Module and Hydraulic Control Unit (ABSCM&H/U).>	Go to step 4.
4 CHECK ANY OTHER DTC APPEARANCE.	Are other DTC being output?	Proceed with the diagnosis corresponding to the DTC.	A temporary poor contact.
5 CHECK FREEZE FRAME DATA. 1) Select "Freeze frame data" on the select monitor. 2) Read front right wheel speed on the select monitor display.	Is the front right wheel speed on the monitor display to 0 km/h (0 MPH)?	Go to step 6.	Go to step 16.
6 CHECK FREEZE FRAME DATA. Read front left wheel speed on the select monitor display.	Is the front left wheel speed on the monitor display to 0 km/h (0 MPH)?	Go to step 7.	Go to step 16.
7 CHECK FREEZE FRAME DATA. Read rear right wheel speed on the select monitor display.	Is the rear right wheel speed on the monitor display to 0 km/h (0 MPH)?	Go to step 8.	Go to step 16.
8 CHECK FREEZE FRAME DATA. Read rear left wheel speed on the select monitor display.	Is the rear left wheel speed on the monitor display to 0 km/h (0 MPH)?	Go to step 9.	Go to step 16.
9 CHECK FREEZE FRAME DATA. Read G sensor output on the select monitor display.	Is the G sensor output on the monitor display more than 3.65 V?	Go to step 10.	Go to step 16.
10 CHECK OPEN CIRCUIT IN G SENSOR OUTPUT HARNESS AND GROUND HARNESS. 1) Turn ignition switch to OFF. 2) Disconnect connector from ABSCM&H/U. 3) Measure resistance between ABSCM&H/U connector terminals. <i>Connector & terminal (F49) No. 6 — No. 28:</i>	Is the measured value within 5.0 to 5.6 kΩ?	Go to step 11.	Repair harness/connector between G sensor and ABSCM&H/U.
11 CHECK BATTERY SHORT OF HARNESS. 1) Turn ignition switch to OFF. 2) Remove console box. 3) Disconnect connector from G sensor. 4) Disconnect connector from ABSCM&H/U. 5) Measure voltage between ABSCM&H/U connector and chassis ground. <i>Connector & terminal (F49) No. 6 (+) — Chassis ground (-):</i>	Is the measured value less than 1 V?	Go to step 12.	Repair harness between G sensor and ABSCM&H/U.

DIAGNOSTICS CHART WITH SUBARU SELECT MONITOR

ABS (DIAGNOSTICS)

Step	Check	Yes	No
12 CHECK BATTERY SHORT OF HARNESS. 1) Turn ignition switch to ON. 2) Measure voltage between ABSCM&H/U connector and chassis ground. Connector & terminal (F49) No. 6 (+) — Chassis ground (-):	Is the measured value less than 1 V?	Go to step 13.	Repair harness between G sensor and ABSCM&H/U.
13 CHECK POOR CONTACT IN CONNECTORS.	Is there poor contact in connector between ABSCM&H/U and G sensor?	Repair connector.	Go to step 14.
14 CHECK ABSCM&H/U. 1) Connect all connectors. 2) Erase the memory. 3) Perform inspection mode. 4) Read out the DTC.	Is the same DTC still being output?	Replace ABSCM&H/U. <Ref. to ABS-6, ABS Control Module and Hydraulic Control Unit (ABSCM&H/U).>	Go to step 15.
15 CHECK ANY OTHER DTC APPEARANCE.	Are other DTC being output?	Proceed with the diagnosis corresponding to the DTC.	A temporary poor contact.
16 CHECK INPUT VOLTAGE OF G SENSOR. 1) Turn ignition switch to OFF. 2) Remove console box. 3) Disconnect G sensor from body. (Do not disconnect connector.) 4) Turn ignition switch to ON. 5) Measure voltage between G sensor connector terminals. Connector & terminal (R70) No. 1 (+) — No. 3 (-):	Is the measured value within 4.75 to 5.25 V?	Go to step 17.	Repair harness/connector between G sensor and ABSCM&H/U.
17 CHECK OPEN CIRCUIT IN G SENSOR OUTPUT HARNESS AND GROUND HARNESS. 1) Turn ignition switch to OFF. 2) Disconnect connector from ABSCM&H/U. 3) Measure resistance between ABSCM&H/U connector terminals. Connector & terminal (F49) No. 6 — No. 28:	Is the measured value within 5.0 to 5.6 k Ω ?	Go to step 18.	Repair harness/connector between G sensor and ABSCM&H/U.
18 CHECK G SENSOR. 1) Connect connector to G sensor. 2) Connect connector to ABSCM&H/U. 3) Turn ignition switch to ON. 4) Measure voltage between G sensor connector terminals. Connector & terminal (R70) No. 2 (+) — No. 3 (-):	Is the measured value within 2.1 to 2.5 V when G sensor is horizontal?	Go to step 19.	Replace G sensor. <Ref. to ABS-21, G Sensor.>
19 CHECK G SENSOR. Measure voltage between G sensor connector terminals. Connector & terminal (R70) No. 2 (+) — No. 3 (-):	Is the measured value within 3.7 to 4.1 V when G sensor is inclined forwards to 90°?	Go to step 20.	Replace G sensor. <Ref. to ABS-21, G Sensor.>
20 CHECK G SENSOR. Measure voltage between G sensor connector terminals. Connector & terminal (R70) No. 2 (+) — No. 3 (-):	Is the measured value within 0.5 to 0.9 V when G sensor is inclined backwards to 90°?	Go to step 21.	Replace G sensor. <Ref. to ABS-21, G Sensor.>
21 CHECK POOR CONTACT IN CONNECTORS. Turn ignition switch to OFF.	Is there poor contact in connector between ABSCM&H/U and G sensor?	Repair connector.	Go to step 22.

DIAGNOSTICS CHART WITH SUBARU SELECT MONITOR

ABS (DIAGNOSTICS)

Step	Check	Yes	No
22 CHECK ABSCM&H/U. 1) Connect all connectors. 2) Erase the memory. 3) Perform inspection mode. 4) Read out the DTC.	Is the same DTC still being output?	Replace ABSCM&H/U. <Ref. to ABS-6, ABS Control Module and Hydraulic Control Unit (ABSCM&H/U).>	Go to step 23 .
23 CHECK ANY OTHER DTC APPEARANCE.	Are other DTC being output?	Proceed with the diagnosis corresponding to the DTC.	A temporary poor contact.

DIAGNOSTICS CHART WITH SUBARU SELECT MONITOR

ABS (DIAGNOSTICS)

AG:DTC 56 ABNORMAL G SENSOR HIGH μ OUTPUT

DIAGNOSIS:

- Faulty G sensor output voltage

TROUBLE SYMPTOM:

- ABS does not operate.

WIRING DIAGRAM:

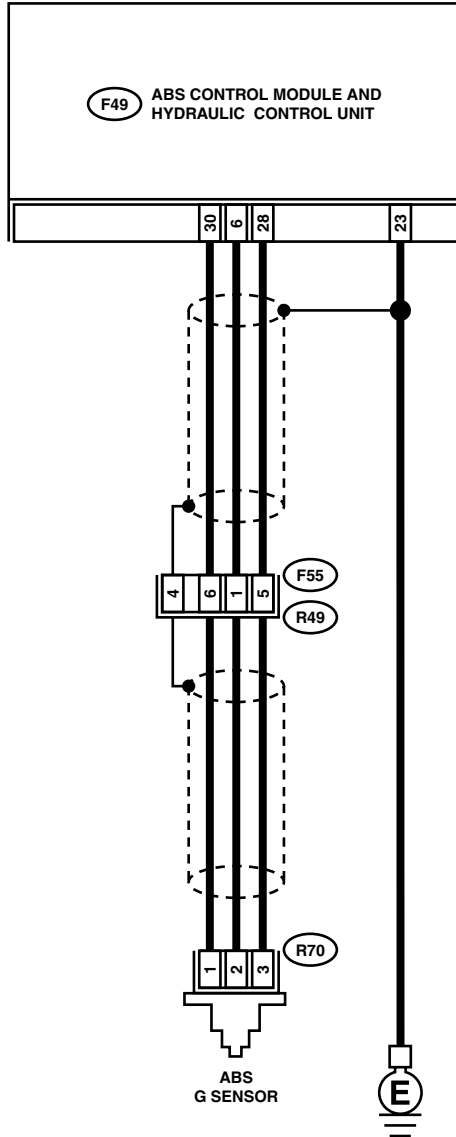

R70

1	2	3
---	---	---

F55

1	2	3	4	5		
6	7	8	9	10	11	12

F49

1	2	3	4	5	6	7	8	9	10	11	12	13	14	15
16	17	18	19	20	21	22	23	24	25	26				
27	28	29	30	31										

ABS00429

DIAGNOSTICS CHART WITH SUBARU SELECT MONITOR

ABS (DIAGNOSTICS)

Step	Check	Yes	No
1 CHECK OUTPUT OF G SENSOR USING SELECT MONITOR. 1) Select "Current data display & Save" on the select monitor. 2) Read G sensor output on the select monitor display.	Is the G sensor output on monitor display within 2.1 to 2.5 V when the G sensor is in horizontal position?	Go to step 2.	Go to step 6.
2 CHECK POOR CONTACT IN CONNECTORS. Turn ignition switch to OFF.	Is there poor contact in connector between ABSCM&H/U and G sensor?	Repair connector.	Go to step 3.
3 CHECK ABSCM&H/U. 1) Connect all connectors. 2) Erase the memory. 3) Perform inspection mode. 4) Read out the DTC.	Is the same DTC still being output?	Replace ABSCM&H/U. <Ref. to ABS-6, ABS Control Module and Hydraulic Control Unit (ABSCM&H/U).>	Go to step 4.
4 CHECK ANY OTHER DTC APPEARANCE.	Are other DTC being output?	Proceed with the diagnosis corresponding to the DTC.	A temporary poor contact.
5 CHECK OPEN CIRCUIT IN G SENSOR OUTPUT HARNESS AND GROUND HARNESS. 1) Turn ignition switch to OFF. 2) Disconnect connector from ABSCM&H/U. 3) Measure resistance between ABSCM&H/U connector terminals. <i>Connector & terminal (F49) No. 6 — No. 28:</i>	Is the measured value within 5.0 to 5.6 k Ω ?	Go to step 6.	Repair harness/connector between G sensor and ABSCM&H/U.
6 CHECK GROUND SHORT OF HARNESS. Measure resistance between ABSCM&H/U connector and chassis ground. <i>Connector & terminal (F49) No. 28 — Chassis ground:</i>	Is the measured value more than 1 M Ω ?	Go to step 7.	Repair harness between G sensor and ABSCM&H/U. Replace ABSCM&H/U. <Ref. to ABS-6, ABS Control Module and Hydraulic Control Unit (ABSCM&H/U).>
7 CHECK G SENSOR. 1) Remove console box. 2) Remove G sensor from vehicle. 3) Connect connector to G sensor. 4) Connect connector to ABSCM&H/U. 5) Turn ignition switch to ON. 6) Measure voltage between G sensor connector terminals. <i>Connector & terminal (R70) No. 2 (+) — No. 3 (-):</i>	Is the measured value within 2.1 to 2.5 V when G sensor is horizontal?	Go to step 8.	Replace G sensor. <Ref. to ABS-21, G Sensor.>
8 CHECK G SENSOR. Measure voltage between G sensor connector terminals. <i>Connector & terminal (R70) No. 2 (+) — No. 3 (-):</i>	Is the measured value within 3.7 to 4.1 V when G sensor is inclined forwards to 90°?	Go to step 9.	Replace G sensor. <Ref. to ABS-21, G Sensor.>
9 CHECK G SENSOR. Measure voltage between G sensor connector terminals. <i>Connector & terminal (R70) No. 2 (+) — No. 3 (-):</i>	Is the measured value within 0.5 to 0.9 V when G sensor is inclined backwards to 90°?	Go to step 10.	Replace G sensor. <Ref. to ABS-21, G Sensor.>

DIAGNOSTICS CHART WITH SUBARU SELECT MONITOR

ABS (DIAGNOSTICS)

Step	Check	Yes	No
10 CHECK ABSCM&H/U. 1) Turn ignition switch to OFF. 2) Connect all connectors. 3) Erase the memory. 4) Perform inspection mode. 5) Read out the DTC.	Is the same DTC still being output?	Replace ABSCM&H/U. <Ref. to ABS-6, ABS Control Module and Hydraulic Control Unit (ABSCM&H/U).>	Go to step 11.
11 CHECK ANY OTHER DTC APPEARANCE.	Are other DTC being output?	Proceed with the diagnosis corresponding to the DTC.	A temporary poor contact.

DIAGNOSTICS CHART WITH SUBARU SELECT MONITOR

ABS (DIAGNOSTICS)

MEMO:

DIAGNOSTICS CHART WITH SUBARU SELECT MONITOR

ABS (DIAGNOSTICS)

AH:DTC 56 DETECTION OF G SENSOR STICK

DIAGNOSIS:

- Faulty G sensor output voltage

TROUBLE SYMPTOM:

- ABS does not operate.

WIRING DIAGRAM:

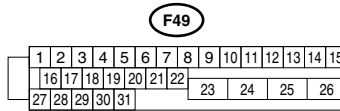
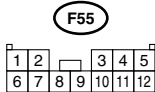
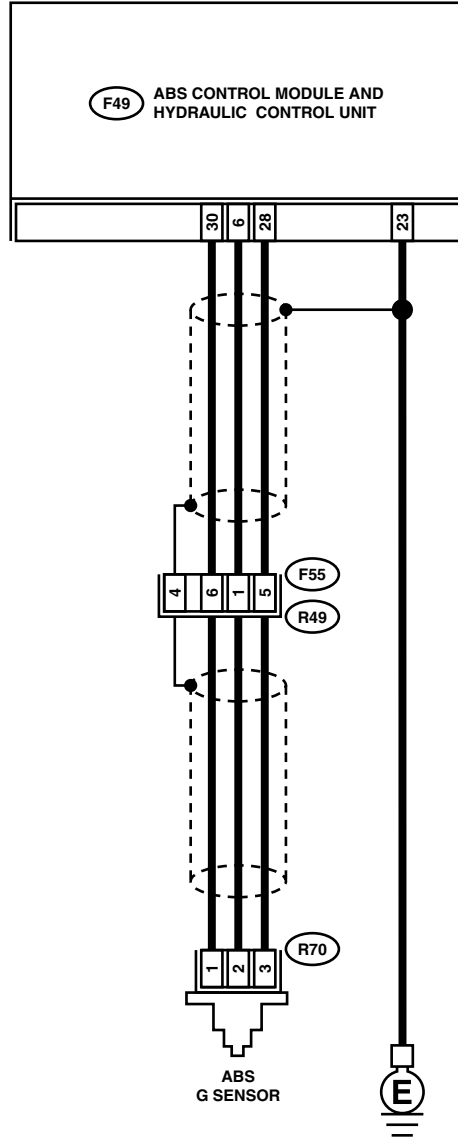

ABS00429

DIAGNOSTICS CHART WITH SUBARU SELECT MONITOR

ABS (DIAGNOSTICS)

Step	Check	Yes	No	
1	CHECK WHEELS FOR FREE TURNING. Check if the wheels have been turned freely such as when the vehicle is lifted up, or operated on a rolling road.	Have wheels turned freely?	The ABS is normal. Erase the trouble code.	Go to step 2.
2	CHECK OUTPUT OF G SENSOR USING SELECT MONITOR. 1) Select "Current data display & Save" on the select monitor. 2) Read the select monitor display.	Is the G sensor output on the monitor display within 2.1 to 2.5 V when the vehicle is in horizontal position?	Go to step 3.	Go to step 8.
3	CHECK OUTPUT OF G SENSOR USING SELECT MONITOR. 1) Turn ignition switch to OFF. 2) Remove console box. 3) Remove G sensor from vehicle. (Do not disconnect connector.) 4) Turn ignition switch to ON. 5) Select "Current data display & Save" on the select monitor. 6) Read the select monitor display.	Is the G sensor output on the monitor display within 3.7 to 4.1 V when G sensor is inclined forwards to 90°?	Go to step 4.	Replace G sensor. <Ref. to ABS-21, G Sensor.>
4	CHECK OUTPUT OF G SENSOR USING SELECT MONITOR. Read the select monitor display.	Is the G sensor output on the monitor display within 0.5 to 0.9 V when G sensor is inclined backwards to 90°?	Go to step 5.	Replace G sensor. <Ref. to ABS-21, G Sensor.>
5	CHECK POOR CONTACT IN CONNECTORS. Turn ignition switch to OFF.	Is there poor contact in connector between ABSCM&H/U and G sensor?	Repair connector.	Go to step 6.
6	CHECK ABSCM&H/U. 1) Connect all connectors. 2) Erase the memory. 3) Perform inspection mode. 4) Read out the DTC.	Is the same DTC still being output?	Replace ABSCM&H/U. <Ref. to ABS-6, ABS Control Module and Hydraulic Control Unit (ABSCM&H/U).>	Go to step 7.
7	CHECK ANY OTHER DTC APPEARANCE.	Are other DTC being output?	Proceed with the diagnosis corresponding to the DTC.	A temporary poor contact.
8	CHECK OPEN CIRCUIT IN G SENSOR OUTPUT HARNESS AND GROUND HARNESS. 1) Turn ignition switch to OFF. 2) Disconnect connector from ABSCM&H/U. 3) Measure resistance between ABSCM&H/U connector terminals. Connector & terminal (F49) No. 6 — No. 28:	Is the measured value within 5.0 to 5.6 kΩ?	Go to step 9.	Repair harness/connector between G sensor and ABSCM&H/U.
9	CHECK G SENSOR. 1) Remove console box. 2) Remove G sensor from vehicle. 3) Connect connector to G sensor. 4) Connect connector to ABSCM&H/U. 5) Turn ignition switch to ON. 6) Measure voltage between G sensor connector terminals. Connector & terminal (R70) No. 2 (+) — No. 3 (-):	Is the measured value within 2.1 to 2.5 V when G sensor is horizontal?	Go to step 10.	Replace G sensor. <Ref. to ABS-21, G Sensor.>

DIAGNOSTICS CHART WITH SUBARU SELECT MONITOR

ABS (DIAGNOSTICS)

Step	Check	Yes	No
10 CHECK G SENSOR. Measure voltage between G sensor connector terminals. <i>Connector & terminal</i> <i>(R70) No. 2 (+) — No. 3 (-):</i>	Is the measured value within 3.7 to 4.1 V when G sensor is inclined forwards to 90°?	Go to step 11.	Replace G sensor. <Ref. to ABS-21, G Sensor.>
11 CHECK G SENSOR. Measure voltage between G sensor connector terminals. <i>Connector & terminal</i> <i>(R70) No. 2 (+) — No. 3 (-):</i>	Is the measured value within 0.5 to 0.9 V when G sensor is inclined backwards to 90°?	Go to step 12.	Replace G sensor. <Ref. to ABS-21, G Sensor.>
12 CHECK ABSCM&H/U. 1) Turn ignition switch to OFF. 2) Connect all connectors. 3) Erase the memory. 4) Perform inspection mode. 5) Read out the DTC.	Is the same DTC still being output?	Replace ABSCM&H/U. <Ref. to ABS-6, ABS Control Module and Hydraulic Control Unit (ABSCM&H/U).>	Go to step 13.
13 CHECK ANY OTHER DTC APPEARANCE.	Are other DTC being output?	Proceed with the diagnosis corresponding to the DTC.	A temporary poor contact.

14. General Diagnostics Table

A: INSPECTION

Symptom		Probable faulty units/parts
Vehicle instability during braking	Vehicle pulls to either side.	<ul style="list-style-type: none"> • ABSCM&H/U (solenoid valve) • ABS sensor • Brake (caliper & piston, pads) • Wheel alignment • Tire specifications, tire wear and air pressures • Incorrect wiring or piping connections • Road surface (uneven, camber)
	Vehicle spins.	<ul style="list-style-type: none"> • ABSCM&H/U (solenoid valve) • ABS sensor • Brake (pads) • Tire specifications, tire wear and air pressures • Incorrect wiring or piping connections
Poor braking	Long braking/stopping distance	<ul style="list-style-type: none"> • ABSCM&H/U (solenoid valve) • Brake (pads) • Air in brake line • Tire specifications, tire wear and air pressures • Incorrect wiring or piping connections
	Wheel locks.	<ul style="list-style-type: none"> • ABSCM&H/U (solenoid valve, motor) • ABS sensor • Incorrect wiring or piping connections
	Brake dragging	<ul style="list-style-type: none"> • ABSCM&H/U (solenoid valve) • ABS sensor • Master cylinder • Brake (caliper & piston) • Parking brake • Axle & wheels • Brake pedal play
	Long brake pedal stroke	<ul style="list-style-type: none"> • Air in brake line • Brake pedal play
	Vehicle pitching	<ul style="list-style-type: none"> • Suspension play or fatigue (reduced damping) • Incorrect wiring or piping connections • Road surface (uneven)
	Unstable or uneven braking	<ul style="list-style-type: none"> • ABSCM&H/U (solenoid valve) • ABS sensor • Brake (caliper & piston, pads) • Tire specifications, tire wear and air pressures • Incorrect wiring or piping connections • Road surface (uneven)
Vibration and/or noise (while driving on slippery roads)	Excessive pedal vibration	<ul style="list-style-type: none"> • Incorrect wiring or piping connections • Road surface (uneven)
	Noise from ABSCM&H/U	<ul style="list-style-type: none"> • ABSCM&H/U (mount bushing) • ABS sensor • Brake piping
	Noise from front of vehicle	<ul style="list-style-type: none"> • ABSCM&H/U (mount bushing) • ABS sensor • Master cylinder • Brake (caliper & piston, pads, rotor) • Brake piping • Brake booster & check valve • Suspension play or fatigue
	Noise from rear of vehicle	<ul style="list-style-type: none"> • ABS sensor • Brake (caliper & piston, pads, rotor) • Parking brake • Brake piping • Suspension play or fatigue

GENERAL DIAGNOSTICS TABLE

ABS (DIAGNOSTICS)

MEMO: